

KD6R309MX Outline drawing

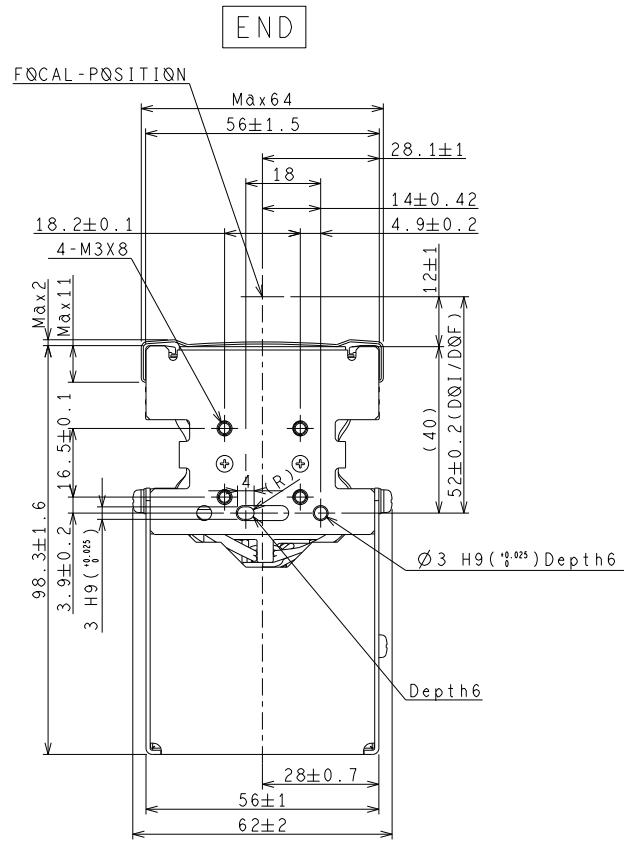
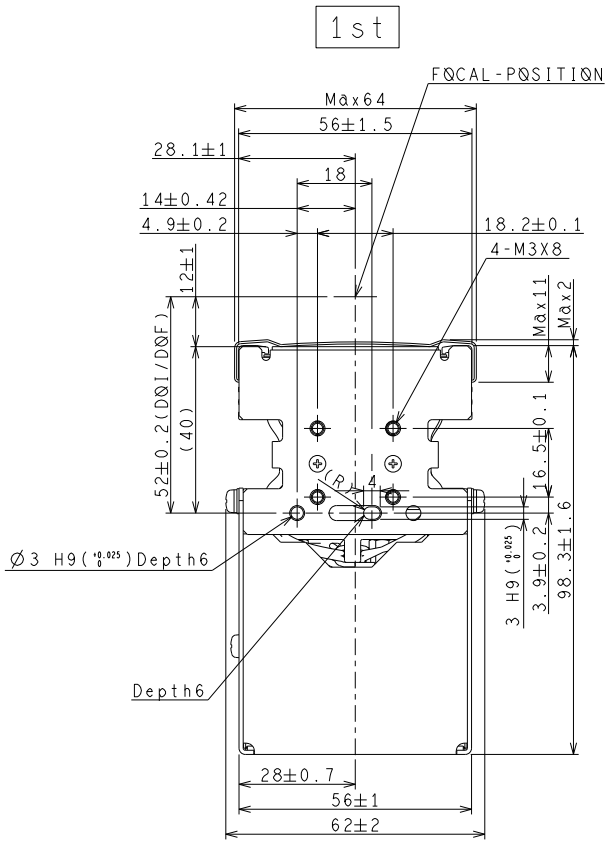

1st-side

End-side

Side view (common mechanism)