

KD6R926MX-NL Outline drawing

1st

END

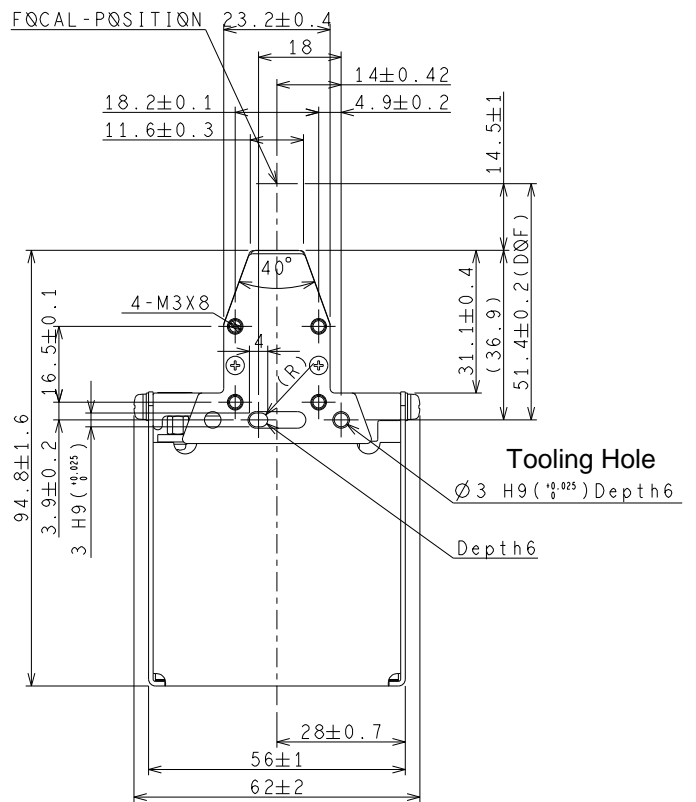
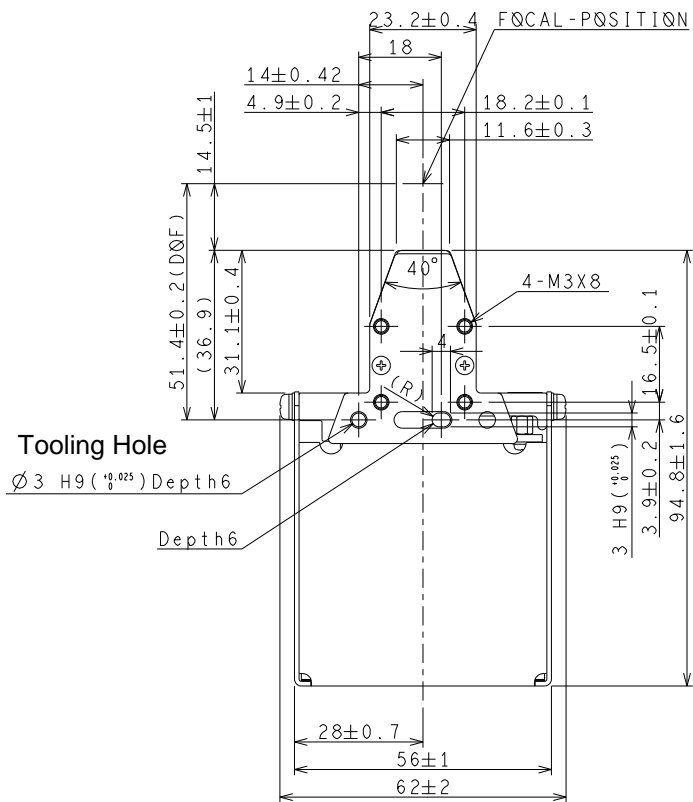

1st-side

End-side

Side view (common mechanism)