

FACTORY AUTOMATION

Graphic Operation Terminal GOT2000 Series/GOT SIMPLE Series



GOT2000

Graphic Operation Terminal

GOT SIMPLE

Graphic Operation Terminal

- Extensive lineup for a wide range of applications
- Remote solutions improve visualization of the shop floor
- GOT and drive control connectivity increases efficiency of the equipment startup and adjustment



Automating the World



Our Factory Automation business is focused on "Automating the World" to make it a better, more sustainable environment supporting manufacturing and society, celebrating diversity and contributing towards an active and fulfilling role.

Mitsubishi Electric is involved in many areas including the following:

Energy and Electric Systems

A wide range of power and electrical products from generators to large-scale displays.

Electronic Devices

A wide portfolio of cutting-edge semiconductor devices for systems and products.

Home Appliance

Dependable consumer products like air conditioners and home entertainment systems.

Information and Communication Systems

Commercial and consumer-centric equipment, products and systems.





Industrial Automation Systems

Maximizing productivity and efficiency with cutting-edge automation technology.



The Mitsubishi Electric Group is actively solving social issues, such as decarbonization and labor shortages, by providing production sites with energy-saving equipment and solutions that utilize automation systems, thereby helping towards a sustainable society.

INDEX

1. Lineup	04	1
2. Hardware	06	2
3. GT SoftGOT2000	26	3
4. GOT Solutions INDEX	32	4
GOT Web-based Remote Solutions	 34	5
Video Interactive Solutions	46	6
GOT Drive Control (Servo) Interactive Solutions	 50	7
GOT Drive Control (Inverter) Interactive Solutions	 68	8
GOT Drive Control (Robot) Interactive Solutions	 74	9
Sophisticated Programmable Controller Interactive Features	75	10
Maintenance, Troubleshooting and Diagnostics Features	80	11
Hardware Features	88	
Security & Additional System Features	92	
Data Handling Features	106	
Interactive Features with Other Industrial Devices	109	
5. MELSOFT iQ Works	116	
6. MELSOFT GT Works3	118	
7. e-F@ctory	138	
8. Specifications	141	
9. Product List	196	
10. Support	206	
11. Related Products	208	



HMI lineup



GOT2000 Series

GT27

Advanced model with multi-touch gesture functions

Ethernet RS-232 RS-422/485 CC-Link IE TSN CC-Link IE Control CC-Link IE Field*1 CC-Link IE Field Basic CC-Link Bus MELSECNET

*1 The CC-Link IE Field Network communication unit and GOT set is also available.

<p>15 inch</p> <p>TFT 65536 colors AC DC</p>  <p>XGA 1024x768</p> <p>GT2715-XTBA GT2715-XTBD</p>	<p>12.1 inch</p> <p>TFT 65536 colors AC DC</p>  <p>SVGA 800x600</p> <p>GT2712-STBA GT2712-STBD GT2712-STWA [White model] GT2712-STWD [White model]</p>	<p>10.4 inch</p> <p>TFT 65536 colors AC DC</p>  <p>SVGA 800x600 VGA 640x480</p> <p>GT2710-STBA GT2710-STBD GT2710-VTBA GT2710-VTBD GT2710-VTWA [White model] GT2710-VTWD [White model]</p>	<p>8.4 inch</p> <p>TFT 65536 colors AC DC</p>  <p>SVGA 800x600 VGA 640x480</p> <p>GT2708-STBA GT2708-STBD GT2708-VTBA GT2708-VTBD</p>
---	---	---	---



High performance, cost efficient, mid-range model

GT25

Ethernet RS-232 RS-422/485 CC-Link IE TSN*2 CC-Link IE Control*2 CC-Link IE Field**2 CC-Link IE Field Basic CC-Link*2 Bus*2 MELSECNET*2

Sound output*2 External I/O*2

*1 The CC-Link IE Field Network communication unit and GOT set is also available. *2 Not supported by GT2505.

<p>12.1 inch</p> <p>TFT 65536 colors AC DC</p>  <p>SVGA 800x600</p> <p>GT2512-STBA GT2512-STBD</p>	<p>10.4 inch</p> <p>TFT 65536 colors AC DC</p>  <p>VGA 640x480</p> <p>GT2510-VTBA GT2510-VTBD GT2510-VTWA [White model] GT2510-VTWD [White model]</p>	<p>8.4 inch</p> <p>TFT 65536 colors AC DC</p>  <p>VGA 640x480</p> <p>GT2508-VTBA GT2508-VTBD GT2508-VTWA [White model] GT2508-VTWD [White model]</p>	<p>5.7 inch</p> <p>TFT 65536 colors AC DC</p>  <p>VGA 640x480</p> <p>GT2505-VTBD</p>
--	---	---	--

GT25

GOT2000 widescreen expands your view

Wide

Ethernet (2 ports) RS-232 RS-422/485 CC-Link IE Field Basic Sound output (built-in)

<p>NEW</p> <p>12.1 inch</p> <p>TFT 65536 colors AC DC</p>  <p>WXGA 1280x800</p> <p>GT2512-WXTBD GT2512-WXTSD</p>	<p>10.1 inch</p> <p>TFT 65536 colors AC DC</p>  <p>WXGA 1280x800</p> <p>GT2510-WXTBD GT2510-WXTSD</p>	<p>7 inch</p> <p>TFT 65536 colors AC DC</p>  <p>WVGA 800x480</p> <p>GT2507-WTBD GT2507-WTSD</p>	<p>7 inch</p> <p>TFT 65536 colors AC DC</p>  <p>WVGA 800x480</p> <p>GT2507T-WTSD</p>
--	--	---	---

GT25

Rugged

Ethernet (2 ports)
RS-232 RS-422/485
CC-Link IE Field Basic
Sound output (built-in)

GT21

Wide

Ethernet RS-232
RS-422/485
CC-Link IE Field Basic

GT21

Compact models with basic functions

Ethernet*1 RS-232*1 RS-422/485*1 CC-Link IE Field Basic*2

*1 Supported interfaces vary depending on the model. Please refer to descriptions in [] after the model.

*2 Supported only by the models equipped with an Ethernet port.

<p>7 inch</p> <p>TFT 65536 colors AC DC</p>  <p>WVGA 800x480</p> <p>GT2107-WTBD GT2107-WTSD</p>	<p>4.3 inch</p> <p>TFT 65536 colors AC DC</p>  <p>480x272</p> <p>GT2104-RTBD [Ethernet, RS-232, RS-422/485]</p>	<p>3.8 inch</p> <p>TFT mono-chrome AC DC</p>  <p>5-color LED 320x128</p> <p>GT2103-PMBD [Ethernet, RS-422/485] GT2103-PMBDS [RS-232, RS-422/485] GT2103-PMBDS2 [RS-232 x 2 channels] GT2103-PMBLS [RS-422] 5 V DC type</p>
--	---	--

Multi-touch gesture | Multimedia*2 | Video/RGB*2 | Sound output | External I/O

*2 Not supported by GT2705.

5.7 inch

TFT
65536
colors

DC



GT2705-VTBD

VGA
640x480

MELIPC Series (related products)

Panel computer with Windows® OS

MI3000

Ethernet (3 ports) | RS-232 | RS-422/485

DisplayPort | Sound output

21.5 inch /
15 inch

TFT
16.77
million
colors

DC

Full HD
1920x1080

MI3321G-W

XGA
1024x768

MI3315G-W



For the details,
see page 208.

GT25 Open frame

A new style of GOT2000

Ethernet | RS-232 | RS-422/485 | CC-Link IE TSN | CC-Link IE Control | CC-Link IE Field | CC-Link IE Field Basic | CC-Link | Bus | MELSECNET

Sound output | External I/O

12.1 inch

TFT
65536
colors

AC

DC



GT2512F-STNA
GT2512F-STND

SVGA
800x600

10.4 inch

TFT
65536
colors

AC

DC



GT2510F-VTNA
GT2510F-VTND

VGA
640x480

8.4 inch

TFT
65536
colors

AC

DC



GT2508F-VTNA
GT2508F-VTND

VGA
640x480

GT25 Handy

HMI functionality in the palm of your hand

Ethernet | RS-232 | RS-422/485*1 | CC-Link IE Field Basic

*1 GT2505HS supports RS-422 only.

6.5 inch

TFT
65536
colors

AC

DC



GT2506HS-VTBD

VGA
640x480

5.7 inch

TFT
65536
colors

AC

DC



GT2505HS-VTBD

VGA
640x480

GT23

Unchallenged cost performance

Ethernet | RS-232 | RS-422/485 | CC-Link IE Field Basic

10.4 inch

TFT
65536
colors

AC

DC



GT2310-VTBA
GT2310-VTBD

VGA
640x480

8.4 inch

TFT
65536
colors

AC

DC



GT2308-VTBA
GT2308-VTBD

VGA
640x480

GOT SIMPLE Series

GS21

Simple model having excellent cost performance

Ethernet | RS-232 | RS-422/485 | CC-Link IE Field Basic

10 inch / 7 inch

TFT
65536
colors

DC



WVGA
800x480

GS2110-WTBD-N
GS2107-WTBD-N

GOT2000 compatible HMI software

GT SoftGOT2000



USB port
license key



GT SoftGOT2000 Version1

Make visualization of production
accessible

GOT Screen Design Software

MELSOFT GT Works3



GOT Screen Design Software
MELSOFT GT Works3

Professional designs in just a few clicks

For the status of conforming to various standards and laws, please contact your local sales office.



GT27 model

Advanced model with multi-touch gesture functions

2

Hardware



A wide variety of specifications suit every system design

Communication interfaces such as Ethernet, RS-232, RS-422/485, USB host/device and SD memory card are standard features. High capacity data processing ensure smooth screen operation even when multiple tasks, such as logging, script, alarm, or device data transfer, are running. In addition, image recording, image playback, video image input, and RGB output are available*, thus all the functions of GOT2000 can be used on GT27 models. *Excluding GT2705

Item	Specifications
Display	5.7"8.4"10.4"12.1"15", TFT color LCD, 65536 colors
Resolution	XGA, SVGA, VGA
Backlight	White LED
User memory	Memory for storage (ROM): 57 MB (GT2705 has 32 MB) Memory for operation (RAM): 256 MB*1 NEW (GT2705 has 80 MB)
Standard interface	Ethernet, RS-232, RS-422/485 USB host (USB-A): 2 channels*2 (USB 2.0 (High-Speed 480 Mbps)) USB device (USB Mini-B): 1 channel (USB 2.0 (High-Speed 480 Mbps)) SD memory card interface
Extension interface	CC-Link IE TSN, CC-Link IE Control, CC-Link IE Field, CC-Link, bus, MELSECNET/H
Side interface	For installing a wireless LAN communication unit

*1 If the function version is B or earlier, the memory for operation (RAM) is 128 MB. Please refer to the Technical Bulletin No. GOT-A-0159 on the Mitsubishi Electric Factory Automation Global website (www.MitsubishiElectric.com/fa/).

*2 White model has 1 channel.

With Backup/Restoration function, fear troubles no more!

The programs and parameters of the programmable controller CPU can be backed up to the SD memory card or USB memory device in the GOT. In case of a CPU failure, users can perform batch operation to restore the data to the controller.

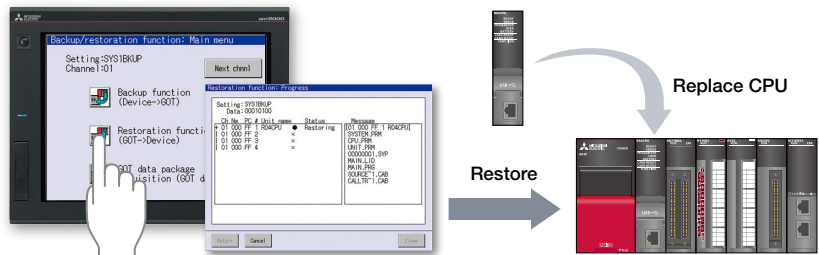

■ GT27 model external appearance [Standard model: front face/rear face]



- 1 **Human sensor**
The unit automatically detects an operator approaching the unit and displays the screen.
* GT2715, GT2712 only
- 2 **USB interface: device (USB Mini-B)**
Connect to a personal computer and transfer data.
* Standard models: front face only
* White models: rear face only
- 3 **USB interface: host (USB-A)*1**
Transfer project data or read the data (logging data, etc.) to or from the GOT using the USB memory.
A USB mouse, keyboard, barcode reader*2, or RFID reader*2 can also be connected.
*1 White models: rear face only
*2 USB keyboard (HID) compatible model only

- 4 **Extension interface**
Communication and option units can be installed.
- 5 **Ethernet interface**
Use Ethernet to simultaneously connect up to four types of industrial devices from different manufacturers. CC-Link IE Field Network Basic compatible devices can also be connected.
- 6 **RS-232 interface**
Connect to various industrial devices, barcode readers and serial printers.
- 7 **RS-422/485 interface**
Connect to various industrial devices and barcode readers.

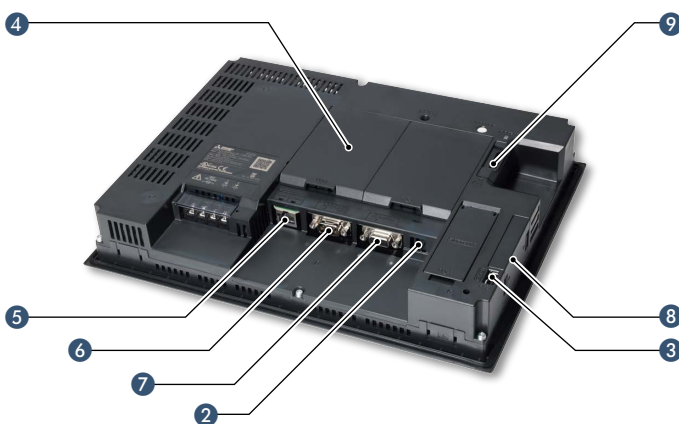

- 8 **Side interface**
Install a wireless LAN communication unit.
- 9 **SD memory card interface**
Save large volumes of data, including alarms and logging data.

■ GT27 model external appearance [White model: front face]

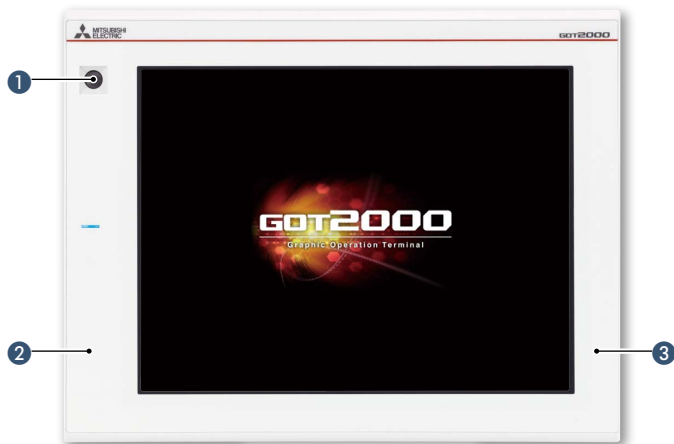

- 1 **Human sensor**
The unit automatically detects an operator approaching the unit and displays the screen.
* GT2712 only
- 2 **Flat body**
The front flat screen is easy to clean. (USB interface is on the back.)
- 3 **White body**
The white model portrays a clean image.

White model features

GOT is acceptable for use in hazardous locations classified by various safety standards (Class I, Division 2 [the United States, Canada], ATEX [the EU member states, the United Kingdom], KCs [Korea]).

* Supported standards vary depending on the model. For the details, please refer to page 88.



GT25 model

High performance, cost efficient, mid-range model

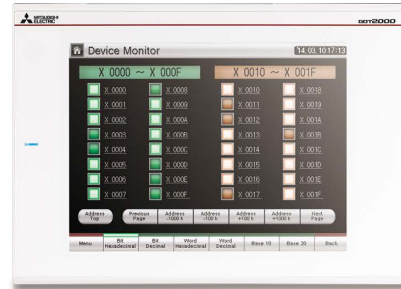
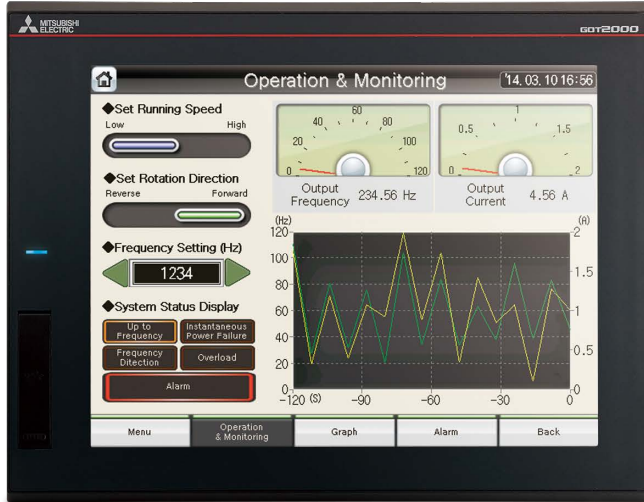

A wide variety of specifications suit every system design

Communication interfaces such as Ethernet, RS-232, RS-422/485, USB host/device and SD memory card are standard features. High capacity data processing ensure smooth screen operation even when multiple tasks, such as logging, script, alarm, or device data transfer, are running.

Item	Specifications
Display	5.7"/8.4"/10.4"/12.1", TFT color LCD, 65536 colors
Resolution	SVGA, VGA
Backlight	White LED
User memory	Memory for storage (ROM): 32 MB Memory for operation (RAM): 80 MB
Standard interface	Ethernet, RS-232, RS-422/485 USB host (USB-A): 2 channels*1 (USB 2.0 (High-Speed 480 Mbps)) USB device (USB Mini-B): 1 channel (USB 2.0 (High-Speed 480 Mbps)) SD memory card interface
Extension interface*2	CC-Link IE TSN, CC-Link IE Control, CC-Link IE Field, CC-Link, bus, MELSECNET/H
Side interface*2	For installing a wireless LAN communication unit

*1 GT2505 and white model have 1 channel.

*2 GT2505 does not have the extension interface and the side interface.

FA Transparent function simplify your debugging work!

By connecting a personal computer to the front USB interface on the GOT, the GOT acts as a transparent gateway to enable startup and adjustment of equipment. Users do not have to bother with opening the electrical cabinet or changing cable connections.

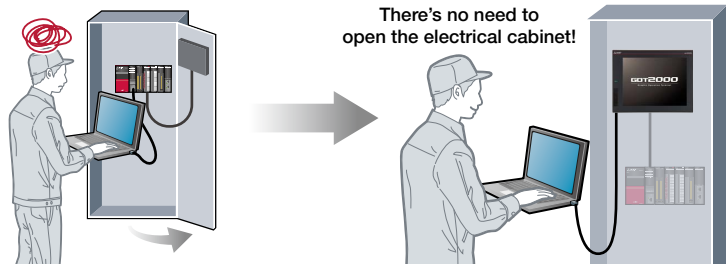

There's no need to open the electrical cabinet!

■ **GT25 standard model external appearance [front face/rear face]** * Excluding GT2505



1 USB interface: device (USB Mini-B)
Connect to a personal computer and transfer data.

* Standard models: front face only
* White models: rear face only

2 USB interface: host (USB-A)*1
Transfer project data or read the data (logging data, etc.) to or from the GOT using the USB memory.
A USB mouse, keyboard, barcode reader*2, or RFID reader*2 can also be connected.

*1 GT2505, white models: rear face only
*2 USB keyboard (HID) compatible model only

3 Extension interface

Communication and option units can be installed.

4 Ethernet interface

Use Ethernet to simultaneously connect up to four types of industrial devices from different manufacturers. CC-Link IE Field Network Basic compatible devices can also be connected.

5 RS-232 interface

Connect to various industrial devices, barcode readers and serial printers.

6 RS-422/485 interface

Connect to various industrial devices and barcode readers.

7 Side interface

Install a wireless LAN communication unit.

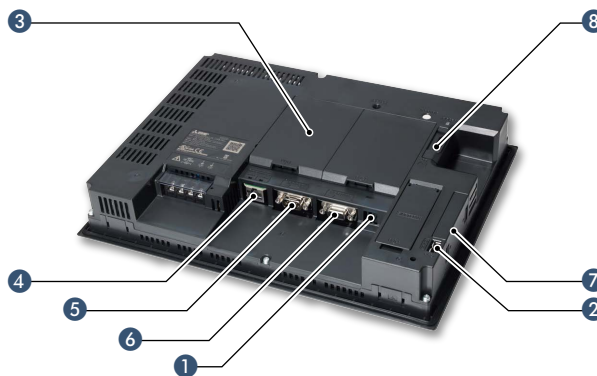

8 SD memory card interface

Save large volumes of data, including alarms and logging data.

■ **GT2505 external appearance [front face/rear face]**

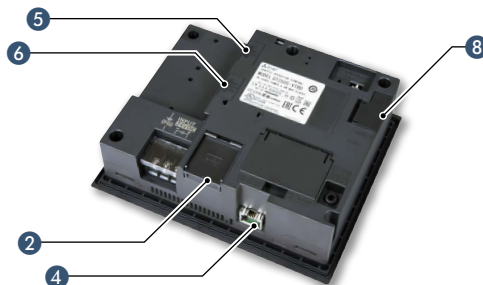

■ **GT25 white model external appearance [front face]**

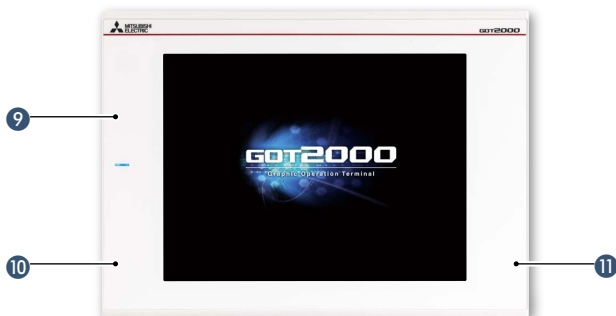

9 Simple design

In the same way as the standard model, the stylish and simple design with a linear motif is sleek and complements any machine design.

10 Flat body

The front flat screen is easy to clean. (USB interface is on the back.)

11 White body

The white model portrays a clean image.

White model features

GOT is acceptable for use in hazardous locations classified by various safety standards (Class I, Division 2 [the United States, Canada], ATEX [the EU member states, the United Kingdom], KCs [Korea]).

* Supported standards vary depending on the model. For the details, please refer to page 88.

GT25 wide model

GOT2000 widescreen expands your view



For the details of GT25 wide models, please refer to the Graphic Operation Terminal GOT2000 Series Wide Model catalog (L(NA)08461ENG).

Various interfaces are equipped in a compact body

The stylish design realized with a narrow bezel. The GOT2000 wide models are available in a choice of silver and black.

Two Ethernet ports and the built-in sound output interface* equipped as standard add value to your system.

* A speaker with built-in amplifier is required separately.

Item	Specifications
Display	7" widescreen / 10.1" widescreen / 12.1" widescreen NEW , TFT color LCD, 65536 colors
Resolution	WVGA, WXGA
Backlight	White LED
User memory	Memory for storage (ROM): 32 MB Memory for operation (RAM): 128 MB
Standard interface	Ethernet (2 ports), RS-232, RS-422/485 USB host (USB-A): 1 channel (USB 2.0 (High-Speed 480 Mbps)) USB device (USB Mini-B): 1 channel (USB 2.0 (High-Speed 480 Mbps)) Sound output interface (Φ3.5 minijack), SD memory card interface
Extension interface	—
Wireless LAN communication unit interface	For installing a wireless LAN communication unit

Ultra high resolution display improves expressiveness

Ultra high resolution WXGA screen* displays necessary and sufficient information on one screen. Small characters can be displayed clearly.

* WXGA display on the 10.1 inch and 12.1 inch models. WVGA display on the 7 inch model.

About 3.3 times higher resolution displays small characters clearly

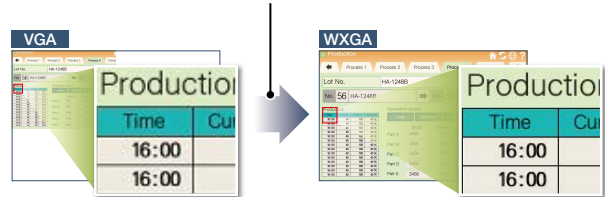

* The example image shows the 10.1 inch model.

Add value to your system with sound notification

The built-in sound output interface makes it easy to implement the sound notification system (pages 90-91, page 136). Not only by displaying the contents of events on the screen but also by notifying with sound, you can convey the necessary information to the operators.

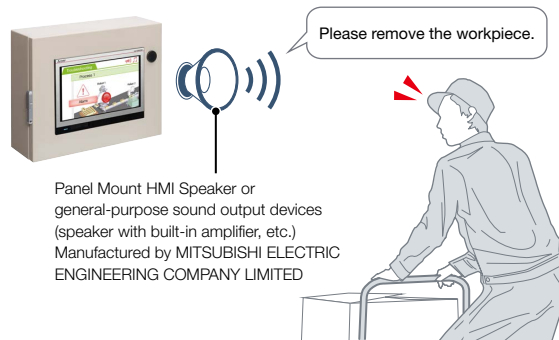

Enable separation of information and control system networks

Two Ethernet ports physically separate the information system network in the office from the control system network at the shop floor. The network architecture becomes safer and more secure by setting different IP addresses for each network.

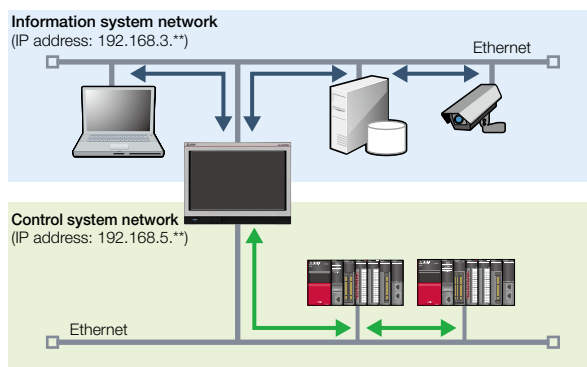

GT25 wide model external appearance [front face/rear face]

* The example picture shows the 10.1 inch model.



1 USB interface: device (USB Mini-B)

Connect to a personal computer and transfer data.

2 USB interface: host (USB-A)

Transfer project data or read the data (logging data, etc.) to or from the GOT using the USB memory. A USB mouse, keyboard, barcode reader*, or RFID reader* can also be connected.

* USB keyboard (HID) compatible model only

3 Ethernet interface (2 ports)

Use Ethernet to simultaneously connect up to four types of industrial devices from different manufacturers. CC-Link IE Field Network Basic compatible devices can also be connected.

4 RS-422/485 interface

Connect to various industrial devices and barcode readers.

5 RS-232 interface

Connect to various industrial devices, barcode readers and serial printers.

6 Sound output interface (Φ3.5 minijack)

Output sound by connecting Φ3.5 stereo mini-plug (3-prong).

7 SD memory card interface

Save large volumes of data, including alarms and logging data.

8 Wireless LAN communication unit interface

Install a wireless LAN communication unit.

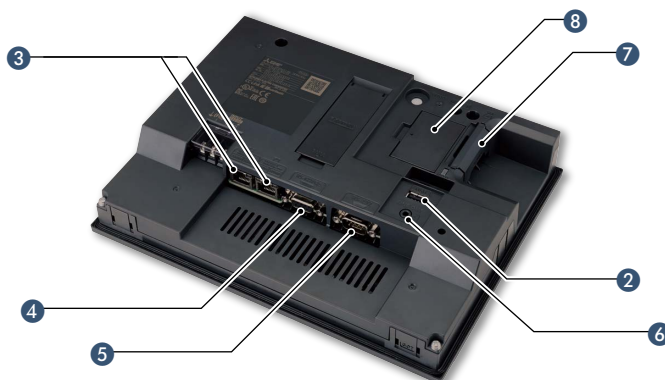



GT25 handy GOT

HMI functionality in the palm of your hand



For the details of GT25 handy GOT, please refer to the Graphic Operation Terminal GOT2000 Series Handy GOT catalog (L(NA)08506ENG).

GOT2000 Series handy GOT

With portable handy GOT, you can operate your machines while standing next to them.

Item	Specifications	
	GT2506HS-VTBD	GT2505HS-VTBD
Display	6.5", TFT color LCD, 65536 colors	5.7", TFT color LCD, 65536 colors
Resolution	VGA	
Backlight	White LED	
User memory	Memory for storage (ROM): 32 MB Memory for operation (RAM): 80 MB Ethernet*2, RS-232*1*2, RS-422/485*1*2	
Standard interface	USB host (USB-A): 1 channel (USB 2.0 (High-Speed 480 Mbps)) USB device (USB Mini-B): 1 channel (USB 2.0 (High-Speed 480 Mbps)) SD memory card interface	

*1 When using GT2506HS, select one channel from RS-232 or RS-422/485.

*2 When using GT2505HS, select one channel from Ethernet, RS-232, or RS-422. RS-485 cannot be used.

Example of connecting GT25 handy GOT and industrial devices

GT2506HS-VTBD

Ethernet connection

- The maximum distance between the connector conversion box and the GOT is 10 m.
- Up to four different industrial devices are connectable.

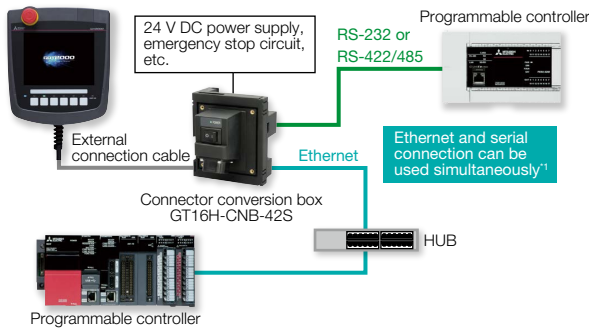

*1 To use Ethernet and serial communication simultaneously, make Communication Settings correctly to enable the multi-channel function.

Serial connection

Connector conversion box

Used to connect handy GOT and industrial devices via Ethernet or serial connection.

Connector conversion box	GT2506HS		GT2505HS	
	Ethernet	RS-232, RS-422/485	Ethernet	RS-232, RS-422
GT16H-CNB-42S ID number recognition function supported	○	○	○	-
GT16H-CNB-37S	○	-	○	-
GT11H-CNB-37S	-	-	-	○

GT2505HS-VTBD

Ethernet connection

- The maximum distance between the connector conversion box and the GOT is 10 m.
- Up to four different industrial devices are connectable.

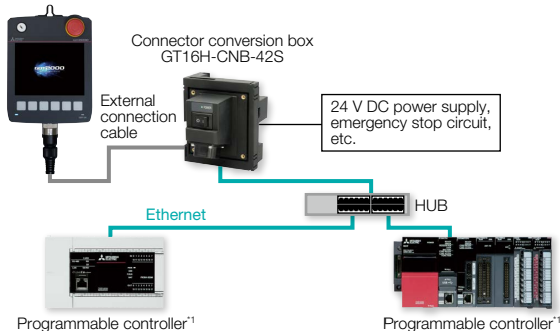

*1 To use third-party programmable controllers, make Communication Settings correctly to enable the multi-channel function.

Serial connection

- Select either of RS-232 or RS-422.
- The maximum distance between the connector conversion box and the GOT is 10 m.

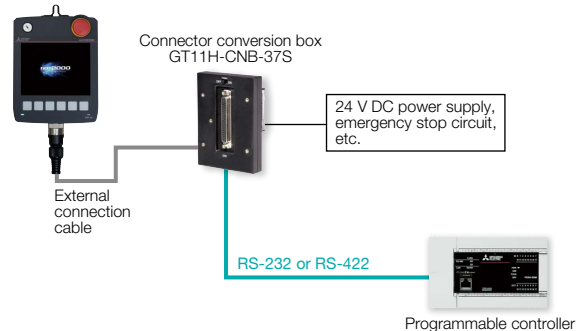

■ **GT2506HS external appearance [front face/rear face]**



- 1 **Emergency stop switch**
An emergency stop switch is used to stop the operation of devices in case of an emergency. It utilizes a "normally closed contact" for safety.
- 2 **LED operation switches (GT2506HS)/ Operation switches (GT2505HS)**
The switches can be used to operate and stop machines. Hard switches on the operation panel are no longer required. These switches can be wired to inputs of programmable controllers and other devices.
- 3 **SD memory card interface**
Save large volumes of data, including alarms and logging data.
- 4 **USB interface: device (USB Mini-B)**
Connect to a personal computer and transfer data.

■ **GT2505HS external appearance [front face/rear face]**



- 5 **USB interface: host (USB-A)**
Transfer project data or read the data (logging data, etc.) to or from the GOT using the USB memory.
- 6 **Keylock switch (2-position switch)**
Operators can be restricted depending on the operation, such as switching manual/automatic operation or selecting the modes. Once the key is pulled out, others cannot operate it. The switch is used with wiring to the input of programmable controllers.
- 7 **Grip switch**
The three-position (OFF-ON-OFF) type deadman switch is adopted as an interlock for preventing operation mistakes and prohibiting operation of a machine. The switch can directly control external equipment to give immediate stop commands to a machine. The switch can be wired to inputs of programmable controllers and other devices.

GT2505HS

Wall-mounting attachment for Handy GOT GT14H-50ATT



The wall-mounting attachment for handy GOT is to place the GT2505 Handy GOT while it is not being used.



Firmly held with four posts, the GOT can be stably placed on the attachment. When you use the GOT, you can quickly remove it and start operation.

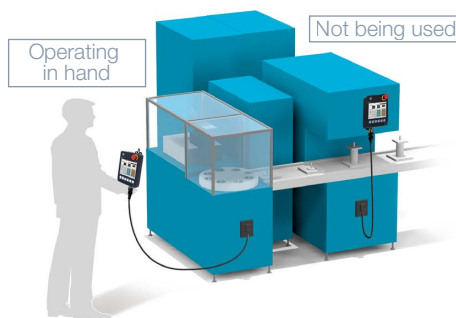



GT25 rugged model

Wide operating temperature range model with a stylish metal housing



For the details of the GT25 rugged model, please refer to the Graphic Operation Terminal GOT2000 Series Rugged Model catalog (L(NA)08555ENG).

Suitable for outdoors or in non air-conditioned rooms

The working ambient temperature has been expanded to -20°C to 65°C. The high-brightness LCD panel (2 times brighter than non-rugged models) provides a clear screen view when installed outdoors. The rugged model is ultraviolet ray resistant with an environmental protection sheet that has UV protection function.

* Note that the structure does not guarantee protection in all users' environments.

High brightness, clear visibility under daylight

The high-brightness LCD panel (1000 cd/m²*) provides a clear screen view even under strong sunlight.

* Brightness of independent panel.



Item	Specifications
Display	7" widescreen, TFT color LCD, 65536 colors
Resolution	WVGA
Backlight	White LED
Panel material	Aluminum
User memory	Memory for storage (ROM): 32 MB Memory for operation (RAM): 128 MB
Standard interface	Ethernet (2 ports), RS-232, RS-422/485 USB host (USB-A): 1 channel (USB 2.0 (High-Speed 480 Mbps)) USB device (USB Mini-B): 1 channel (USB 2.0 (High-Speed 480 Mbps)) Sound output interface (Φ3.5 minijack), SD memory card interface
Extension interface	—
Wireless LAN communication unit interface	For installing a wireless LAN communication unit interface
Operating ambient temperature	-20 °C to 65 °C
Brightness (LCD panel)	1000 cd/m ² (Typ)
UV cutoff	Approximately 95% (370 nm)
Protective structure	Front: IP66F, IP67F Inside control panel: IP2X
Vibration resistance	19.6 m/s ² (continuous), 19.6 m/s ² (intermittent)
Shock resistance	392 m/s ² (40G)
Dedicated option	UV protective sheet, protective cover for oil, stand



UV resistant

Ultraviolet rays are cut by approximately 95% (370 nm) with a UV-cutting layer and UV-absorbing layer. Degradation of the LCD panel or touch panel caused by ultraviolet rays is reduced. Use the optional UV protection sheet to further improve resistance to ultraviolet rays.

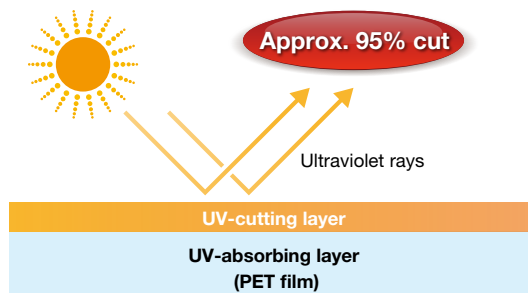

Vibration and shock resistant

Since the structure of the front panel has been reinforced with a metal housing, the rugged model can be used in environments that are subject to vibration or shock, such as construction equipment or snow plows.



■ GT25 rugged model external appearance [front face/rear face]



1 GOT front face

The metal enclosure increases resistance against vibration and shock. Ultraviolet rays are cut by approximately 95% (370 nm). Also comply with IP66F and IP67F ratings.

2 Ethernet interface (2 ports)

Use Ethernet to simultaneously connect up to four types of industrial devices from different manufacturers. CC-Link IE Field Network Basic compatible devices can also be connected.

3 RS-422/485 interface

Connect to various industrial devices and barcode readers.

4 RS-232 interface

Connect to various industrial devices, barcode readers and serial printers.

5 Sound output interface (Ø3.5 minijack)

Output sound by connecting Ø3.5 stereo mini-plug (3-prong).

6 USB interface: host (USB-A)

Transfer project data or read the data (logging data, etc.) to or from the GOT using the USB memory. A USB mouse, keyboard, barcode reader*, or RFID reader* can also be connected.

* USB keyboard (HID) compatible model only

7 USB interface: device (USB Mini-B)

Connect to a personal computer and transfer data.

8 SD memory card interface

Save large volumes of data, including alarms and logging data.

9 Wireless LAN communication unit interface

Install a wireless LAN communication unit.

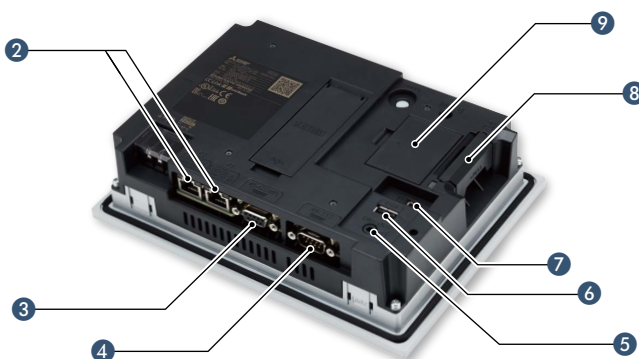



GT25 open frame model

A new style of GOT2000

2

Hardware



For the details of the GT25 open frame model, please refer to the Graphic Operation Terminal GOT2000 Series White & Open catalog (L(NA)08414ENG).

GOT complements machine design

Installing the GOT2000 from the back side of the control panel complements the machine-design surface. Using a stainless-look environmental protection sheet allows the touch panel to blend into the production machines for the pharmaceutical and food industries.

Item	Specifications
Display	8.4"/10.4"/12.1", TFT color LCD, 65536 colors
Resolution	SVGA, VGA
Backlight	White LED
User memory	Memory for storage (ROM): 32 MB Memory for operation (RAM): 80 MB
Standard interface	Ethernet, RS-232, RS-422/485 USB host (USB-A): 1 channel (USB 2.0 (High-Speed 480 Mbps)) USB device (USB Mini-B): 1 channel (USB 2.0 (High-Speed 480 Mbps)) SD memory card interface
Extension interface	CC-Link IE TSN, CC-Link IE Control, CC-Link IE Field, CC-Link, bus, MELSECNET/H
Side interface	For installing a wireless LAN communication unit

IP67F protection

To conform to IP67F, attach an environmental protection sheet.* GOT can be operated with wet hands, wiped with a damp cloth, and washed with water.

* Note that the structure does not guarantee protection in all users' environments. The GOT may not be used in certain environments where it is subjected to splashing oil or chemicals for a long period of time or soaked in oil mist.



Suitable for pharmaceutical and food industries

Flush surface without any gaps and grooves prevents dust, dirt, and debris from accumulated on the edge.



■ GT25 open frame model external appearance [front face/rear face]



1 Touch panel

Using an environmental protection sheet (optional or prepared by the users) is required.

2 Unit installation fitting

Fittings to install GOT to a panel are included.

3 Extension interface

Communication and option units can be installed.

4 Ethernet interface

Use Ethernet to simultaneously connect up to four types of industrial devices from different manufacturers. CC-Link IE Field Network Basic compatible devices can also be connected.

5 RS-232 interface

Connect to various industrial devices, barcode readers and serial printers.

6 RS-422/485 interface

Connect to various industrial devices and barcode readers.

7 Side interface

Install a wireless LAN communication unit.

8 SD memory card interface

Save large volumes of data, including alarms and logging data.

9 USB interface: device (USB Mini-B)

Connect to a personal computer and transfer data.

10 USB interface: host (USB-A)

Transfer project data or read the data (logging data, etc.) to or from the GOT using the USB memory. A USB mouse, keyboard, barcode reader*, or RFID reader* can also be connected.

* USB keyboard (HID) compatible model only

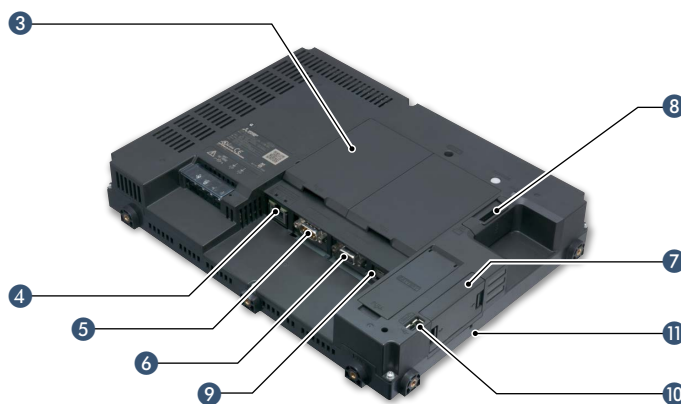

11 POWER LED

Check the power supply status.

■ Easy installation

Adjustable to various panels

The installation fitting is adjustable from 1.5 mm to 4 mm of the control panel thickness. GOT can adjust the difference of the control panel thickness. Vertical installation is also available.

Designed for safe installation

The edge of the touch panel is protected to prevent damage to the touch panel or injury by touching the sharp edge. It is possible to safely install the GOT.

Dedicated installation fittings

Attach appropriate installation fittings (vertical/horizontal) depending on the installation orientation.

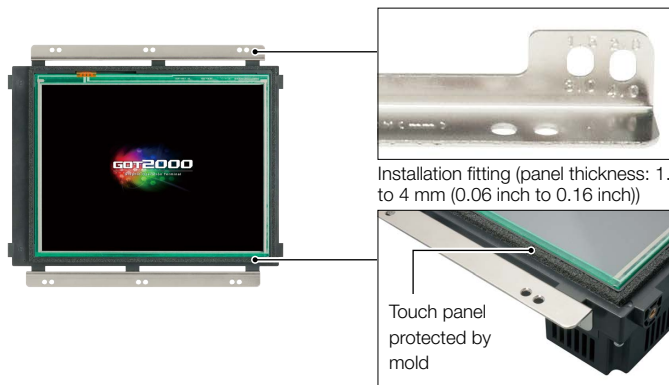

Designed for safe installation

Installation instructions

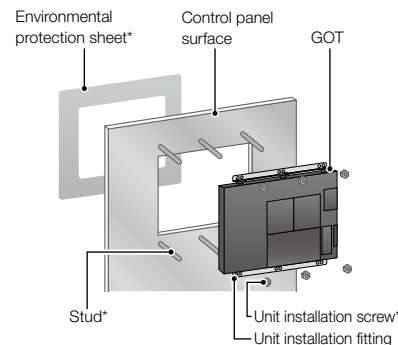

* An environmental protection sheet (optional or prepared by the users), studs and screws (prepared by the users) are required separately.

GT23 model

Unchallenged cost performance



A wide variety of specifications suit every system design

Communication interfaces such as Ethernet, RS-232, RS-422/485, USB host/device and SD memory card are standard features. Advanced interactive features such as data logging, multi-channel communication, and FA transparent function are supported.

Item	Specifications
Display	8.4"/10.4", TFT color LCD, 65536 colors
Resolution	VGA
Backlight	White LED
User memory	Memory for storage (ROM): 9 MB Memory for operation (RAM): 9 MB
Standard interface	Ethernet, RS-232, RS-422/485 USB host (USB-A): 1 channel (USB 1.1 (Full-Speed 12 Mbps)) USB device (USB Mini-B): 1 channel (USB 1.1 (Full-Speed 12 Mbps)) SD memory card interface

Use the System Launcher function and quickly check the system status!

A graphical system configuration diagram indicates module statuses. When you touch a module the extended function list is shown and you can carry out maintenance work efficiently.

System configuration diagram

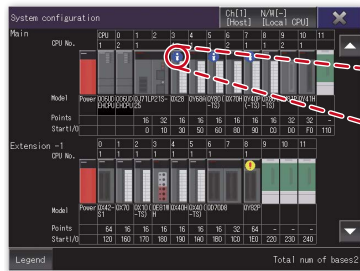

Icons show the module status. You can check the module with an error at a glance.

Extended functions menu

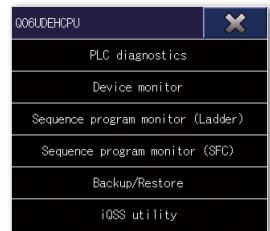

■ GT23 model external appearance [Standard model: front face/rear face]



1 Simple design

The simple design with a linear motif is sleek and complements any machine design.

2 Flat body

The front flat screen is easy to clean. (USB interface is on the back.)

3 Ethernet interface

Use Ethernet to simultaneously connect up to two types of industrial devices from different manufacturers. CC-Link IE Field Network Basic compatible devices can also be connected.

4 RS-232 interface

Connect to various industrial devices, barcode readers and serial printers.

5 RS-422/485 interface

Connect to various industrial devices and barcode readers.

6 USB interface: device (USB Mini-B)

Connect to a personal computer and transfer data.

7 USB interface: host (USB-A)

Transfer project data or read the data (logging data, etc.) to or from the GOT using the USB memory. A USB mouse, keyboard, barcode reader*, or RFID reader* can also be connected.

* USB keyboard (HID) compatible model only

8 SD memory card interface

Save large volumes of data, including alarms and logging data.

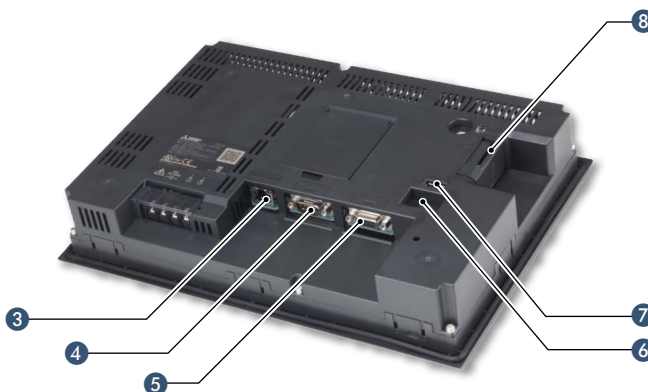

Easily collect log data and display it in graphs and lists

Use the GOT to collect data from the programmable controller and temperature controllers. The data can be displayed in graphs and lists. It can also be exported to a personal computer for further analysis. The logging data can be saved in the built-in SRAM even if the power fails.

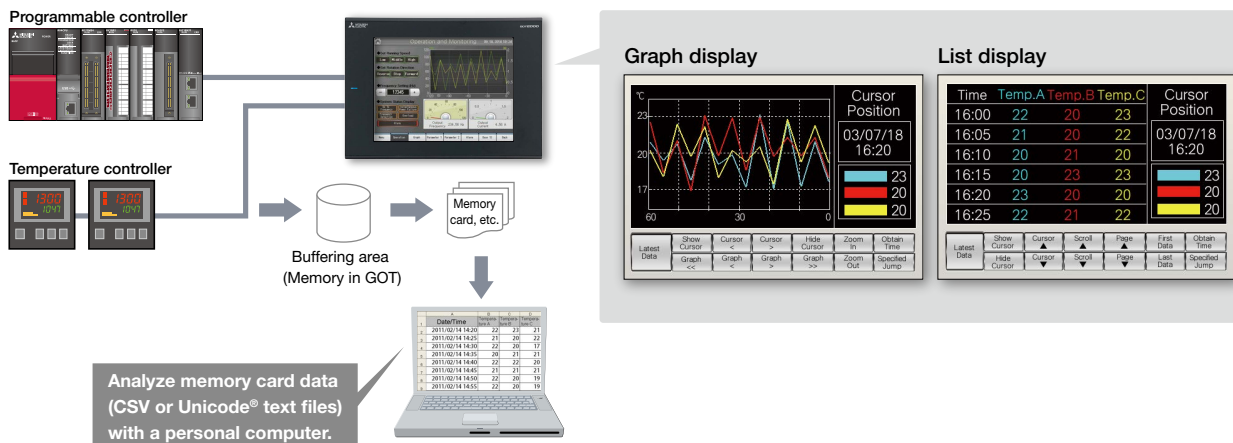

For details

Concept movie



GT21 wide model

Expands possibilities of GT21 models

2

Hardware



Smart silver



Cool black



For the details of GT21 wide models, please refer to the Graphic Operation Terminal GOT2000 Series Wide Model catalog (L(NA)08461ENG).

The highest resolution screen in the GT21 models, with various built-in interfaces

The GOT2000 wide models are available in a choice of silver and black. In addition to the high resolution display, 65536 colors of LCD improves quality of screen display. The first GT21 model with the USB host enables you to connect a USB mouse and keyboard, or transfer data using a USB memory. In addition, Ethernet printers can be used.

Item	Specifications
Display	7" widescreen, TFT color LCD, 65536 colors
Resolution	WVGA
Backlight	White LED
User memory	Memory for storage (ROM): 15 MB
Standard interface	Ethernet, RS-232, RS-422/485 USB host (USB-A): 1 channel (USB 1.1 (Full-Speed 12 Mbps)) USB device (USB Mini-B): 1 channel (USB 1.1 (Full-Speed 12 Mbps)) SD memory card interface

Widescreen displays large amounts of information

High resolution WVGA screen has sufficient display area for long alarm messages.

5 times higher resolution greatly increases expressiveness

Standard GT1055-Q

QVGA 320 × 240 dots



Wide GT2107-W

WVGA 800 × 480 dots



Remote monitoring provides wide access to application

Remote monitoring with the VNC server function is available. By remotely connecting to GOT from personal computer or tablet, you can operate, monitor production equipment and connect to system devices.

* GT2107-W only among GT21 models.



Enhanced graphics

Outline fonts can now be used on GT21 model. Antialiasing smoothes out jagged text edges and displays clear characters, offering improved visibility of screen display.

* GT2107-W only among GT21 models.

Standard 16dot HQ Gothic

Trend graph

Wide Outline Gothic (antialiasing enabled)

Trend graph

Clear characters improve visibility

■ GT21 wide model external appearance [front face/rear face]



1 USB interface: device (USB Mini-B)

Connect to a personal computer and transfer data.

2 USB interface: host (USB-A)

Transfer project data or read the data (logging data, etc.) to or from the GOT using the USB memory. A USB mouse, keyboard, barcode reader*, or RFID reader* can also be connected.

* USB keyboard (HID) compatible model only

3 Ethernet interface

Use Ethernet to simultaneously connect up to two types of industrial devices from different manufacturers. CC-Link IE Field Network Basic compatible devices can also be connected.

4 RS-422/485 interface

Connect to various industrial devices and barcode readers.

5 RS-232 interface

Connect to various industrial devices, barcode readers and serial printers.

6 SD memory card interface

Save large volumes of data, including alarms and logging data.

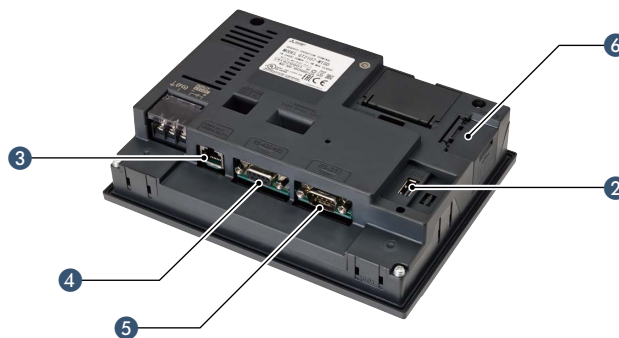



GT21 model

■ GT2104-R

Compact model with exciting possibilities



Widescreen type compact model!

High resolution, 480 × 272 dot display realized in a compact body!

Item	Specifications
Display	4.3", TFT color LCD, 65536 colors
Resolution	480 × 272 dots
Backlight	White LED
User memory	Memory for storage (ROM): 9 MB
Standard interface	Ethernet, RS-232, RS-422/485 USB device (USB Mini-B): 1 channel (USB 1.1 (Full-Speed 12 Mbps)) SD memory card interface

Wide screen display fits a lot of data!

The wide model shows a large amount of information on a 65536 color display.



4.7 inch Screen size: 4.7 inch
Resolution: 320 × 240
Display color: 256 colors



4.3 inch Screen size: 4.3 inch
Resolution: 480 × 272
Display color: 65536 colors

Resolution
1.5 times wider in horizontal direction

■ GT2104-R external appearance [front face/rear face]



1 Simple design

The simple design with a linear motif is sleek and complements any machine design.

2 Flat body

The front flat screen is easy to clean. (USB interface is on the back.)

3 USB interface: device (USB Mini-B)

Connect to a personal computer and transfer data.

4 Ethernet interface

Use Ethernet to simultaneously connect up to two types of industrial devices from different manufacturers. CC-Link IE Field Network Basic compatible devices can also be connected.

5 RS-422/485 interface

Connect to various industrial devices and barcode readers.

6 RS-232 interface

Connect to various industrial devices, barcode readers and serial printers.

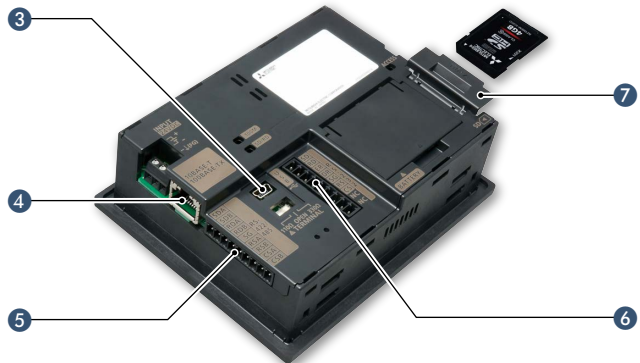

7 SD memory card interface

Save large volumes of data, including alarms and logging data.

■ GT2103-PMBD

Small screen, big possibilities



Small, compact, easy to operate!

Ethernet built into a compact body!
The intuitively understandable 5-color backlight offers choices of backlight color and backlight blink according to machine operation state.

Item	Specifications
Display	3.8", monochrome (black/white), 32 shade grayscale TFT LCD display
Resolution	320 × 128 dots
Backlight	5-color LED (white, green, pink, orange, red)
User memory	Memory for storage (ROM): 3 MB
Standard interface	Ethernet, RS-422/485 USB device (USB Mini-B): 1 channel (USB 1.1 (Full-Speed 12 Mbps))
Extension interface	For installing an SD memory card unit

High-definition LCD

GT2103 is equipped with an easy to see, compact high-resolution TFT LCD with 32 gray scales.



Same compact type, but so much clearer!

GT1020
Monochrome (black/white) STN LCD

GT2103
Monochrome TFT LCD with 32 gray scales

* Comparison of GT1020 and GT2103-P

SD memory card unit is available!

SD memory cards can be used when the optional SD memory card unit is attached.



SD memory card unit **GT21-03SDCD**
Separate SD memory card is required.

■ GT2103-PMBD external appearance [rear face]

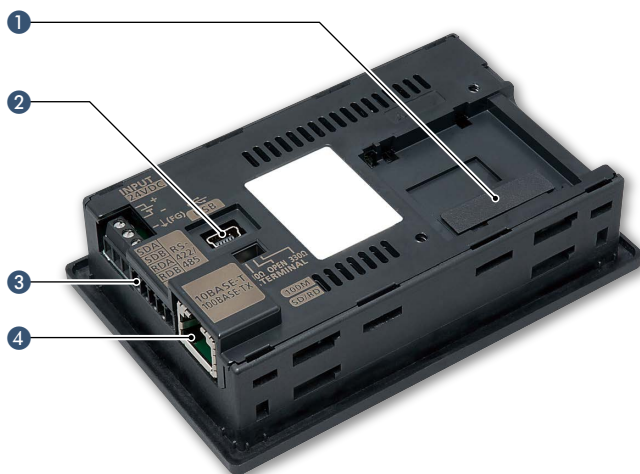

- ① **SD memory card unit interface**
Connect an optional SD memory card unit and save data including alarms and logging data.
* Excluding GT2103-PMBLS
- ② **USB interface: device (USB Mini-B)**
Connect to a personal computer and transfer data.
- ③ **RS-422/485 interface**
Connect to various industrial devices and barcode readers.
* Excluding GT2103-PMBDS2
* RS-422 on GT2103-PMBLS (dedicated to FX connection)
- ④ **Ethernet interface**
Use Ethernet to simultaneously connect up to two types of industrial devices from different manufacturers. CC-Link IE Field Network Basic compatible devices can also be connected.
* GT2103-PMBD only

New Version

GOT SIMPLE

The GOT SIMPLE Series upgrade brings the most demanded new features



10" widescreen, GS2110-WTBD-N



7" widescreen, GS2107-WTBD-N



For the details of the GOT SIMPLE Series, please refer to the Graphic Operation Terminal GOT SIMPLE Series catalog (L(NA)08649ENG).

The GOT SIMPLE Series with the most demanded features enables remote maintenance

User memory capacity is now increased to 15 MB. Outline fonts offer improved visibility of screen display. In addition, remote maintenance is possible using the VNC server function, and thus monitoring devices from a remote location improves work efficiency.

* To design screens of the upgraded GOT SIMPLE Series, it is required to use GT Works3 Version1.250L or later.

Item	Specifications	
	GS2110-WTBD-N	GS2107-WTBD-N
Display	10" widescreen, TFT color LCD, 65536 colors	7" widescreen, TFT color LCD, 65536 colors
Resolution	WVGA: 800 × 480 dots	
Backlight	White LED	
User memory	Memory for storage (ROM): 15 MB	
Standard interface	Ethernet, RS-232, RS-422/485 USB device (USB Mini-B): 1 channel (USB1.1 (Full-Speed 12 Mbps)) SD memory card interface	

Expanded user memory capacity (9 MB ➔ 15 MB)

The user memory capacity has been expanded to 15 MB from the GOT SIMPLE Series previous model. There is no need to worry about the project data size when designing screens.

User memory capacity comparison

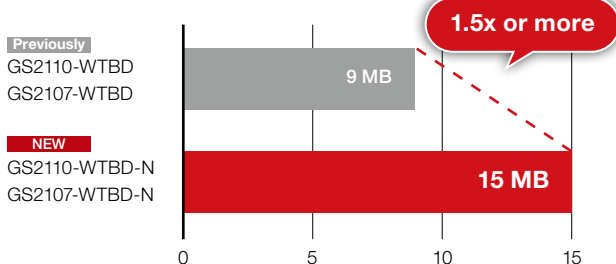

Support RS-485 connection

A common interface for RS-422 and RS-485 connections is available. Temperature controllers and MODBUS® devices can be connected.



Temperature controllers and MODBUS® devices

Support outline font

Outline fonts can now be used on the GOT SIMPLE Series. Antialiasing smoothes out text edges and displays clear characters, offering improved visibility of screen display.

Enhanced traceability for easy troubleshooting Operation log function

GOT records the operation information, such as the “what, when, and how” of an operation performed, in chronological order in an SD memory card. Use of the operation log function combined with the operator authentication function records additional information of “who” performed the operation.

Remote maintenance by using the VNC server function

If a problem occurred in a remote location, it is easy to monitor the GOT from your office and take corrective actions quickly.

Previously

Trend graph

16dot HQ Gothic

NEW

Trend graph

Outline Gothic (antialiasing enabled)

Clear characters improve visibility

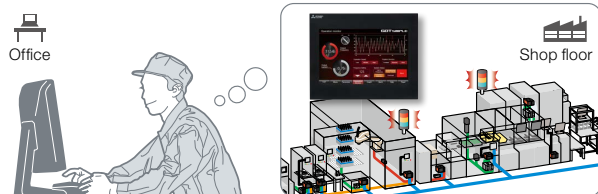
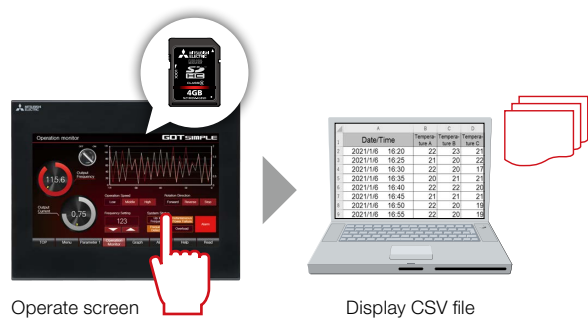

■ GOT SIMPLE Series external appearance [front face/rear face]



1 GOT front face

IP65F front face protection is useful for various production machines and facilities.

2 Ethernet interface

Use Ethernet to simultaneously connect up to two types of industrial devices (programmable controllers, inverters, servo amplifiers, etc.) from different manufacturers. CC-Link IE Field Network Basic compatible devices can also be connected.

3 RS-232 interface

Connect to various industrial devices, barcode readers and serial printers. Supported connection to BRIGHTTEK printers by using the RS-232 interface.

* For the connectable printers, please refer to the Technical Bulletin “List of Valid Devices Applicable for GOT2000 Series and GOT SIMPLE Series for Overseas” (GOT-A-0160).

4 RS-422/485 interface

Connect to various industrial devices (programmable controllers, inverters, servo amplifiers, etc.), barcode readers, temperature controllers, and MODBUS® devices.

5 USB interface: device (USB Mini-B)

Connect to a personal computer and transfer data.

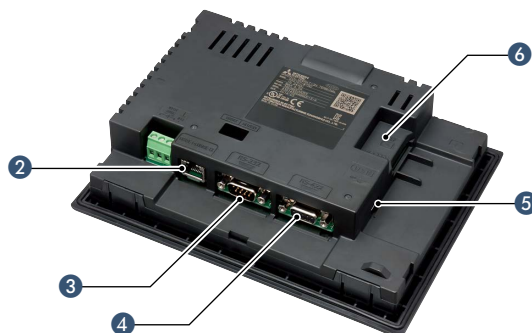

6 SD memory card interface

Save large volumes of data, including alarms and logging data.



GOT2000 compatible HMI software
GT SoftGOT2000

Turn your personal computer or panel computer into GOT2000



For the details of GT SoftGOT2000, please refer to the GT SoftGOT2000 Solutions catalog (L(NA)08606ENG).

License key (for USB port)

High affinity with GOT2000 Series

Functions equivalent to the GOT2000 Series can be used in GT SoftGOT2000. The project data created with HMI/GOT Screen Design Software GT Works3 can be used by converting it into the GT SoftGOT2000 data.

► For the supported functions, see “Function list” on page 166.

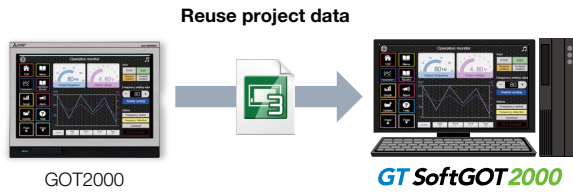

Same operability with GOT2000 Series

In addition to touch operations, long press can also be used. Using momentary switches and delay settings enables safe operation and improves operability.



MI3000 with GT SoftGOT2000

► GT SoftGOT2000 is preinstalled on MELIPC MI3000. For the details, see page 208.

System configurations

GT SoftGOT2000 can be used in single channel connection that monitors one channel and in multi-channel connection that enables monitoring up to four channels of industrial devices. Select the connection type to match your system configuration.

Single channel connection (GT SoftGOT2000)

Connectable in all communication types that are supported by GT SoftGOT2000.

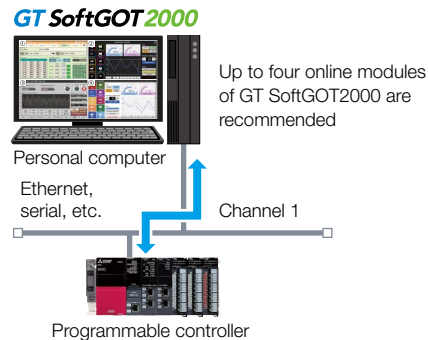

Multi-channel connection (GT SoftGOT2000 (Multi-channel))

Multi-channel connection is supported in Ethernet connection, connection with OPC UA servers, and microcomputer connection only. Up to four channels of industrial devices can be monitored on a single module of GT SoftGOT2000.

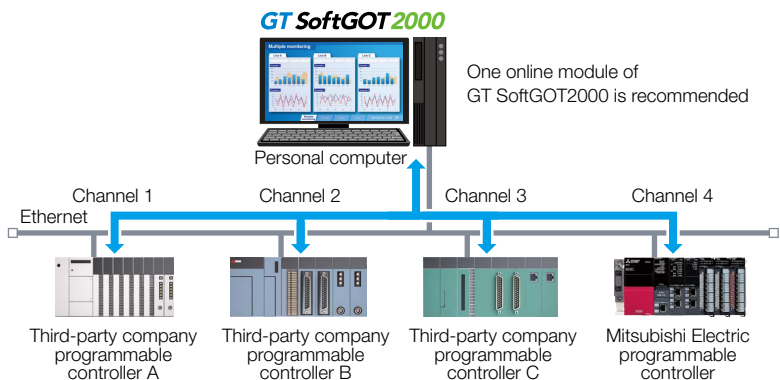

Connectable to OPC UA servers

GT SoftGOT2000 accesses an OPC UA server as an OPC UA client.*1

*1 To connect to OPC UA servers, installation of MELSOFT GT OPC UA Client software is required. To use the OPC UA client connection, use Windows® 7 OS or later. For more information about how to obtain the software, please contact your local sales office.

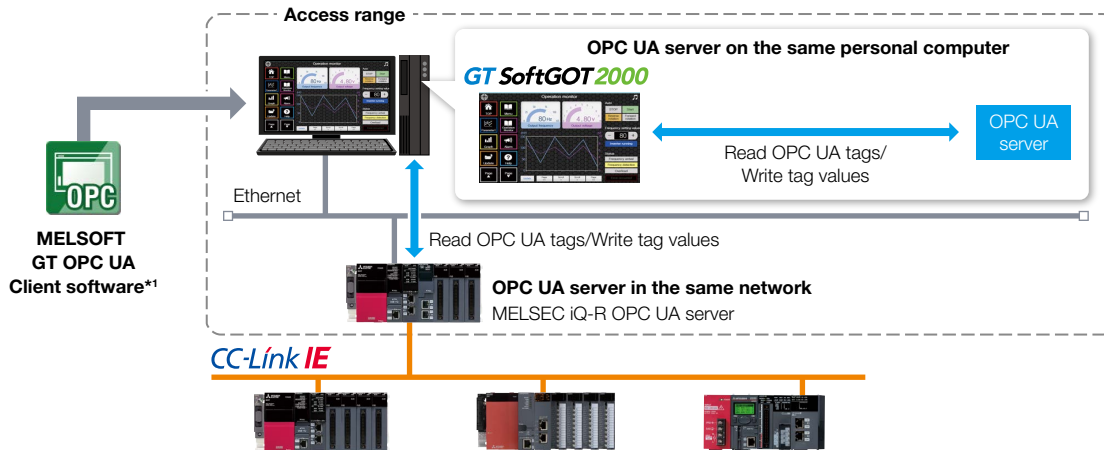

Edgexross interaction

Edgecross is the open software platform in Japan in the edge computing field that coordinates factory automation and IT systems. Edgecross analyzes and diagnoses data near the shop floor and enables real time feedback to the production, data collection, and sending or receiving data to/from facilities and equipment regardless of vendors and network types. The data collected by Edgecross can be easily visualized and analyzed using various functions such as trend graph display on GT SoftGOT2000.

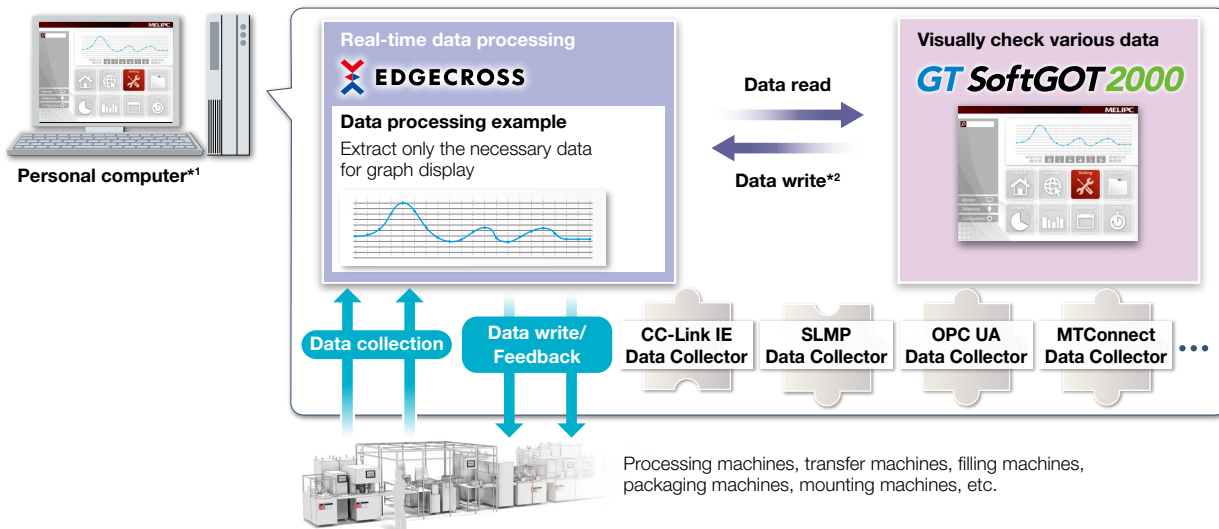

*1 It is required to install Edgexross Basic Software, Data Collector, and GT SoftGOT2000 on a personal computer.

*2 To write data from GT SoftGOT2000 to Edgexross Basic Software, installation of MELSOFT GT OPC UA Client software is required separately.

Flexible resolution setting

The users can flexibly specify resolutions to change the screen size depending on the information device to use.



The same screens as the on-site GOT can be monitored on an office computer (SoftGOT-GOT link function)

If GOT is used at the shop floor, GT SoftGOT2000 reads project data from the GOT via Ethernet, and uses the project data to monitor connected devices. There is no need to create project data dedicated for GT SoftGOT2000 and quick remote monitoring of industrial devices is enabled via Ethernet. Since GT SoftGOT2000 can also display a different screen from the one shown on the GOT at the shop floor, monitoring on GT SoftGOT2000 does not affect shop floor operation. In addition, exclusive control of authorization is provided as standard to prevent simultaneous operations and ensure safe operation.

* SoftGOT-GOT link function is supported by GT27 and GT25. Not supported by GT23, GT21, and GS21.

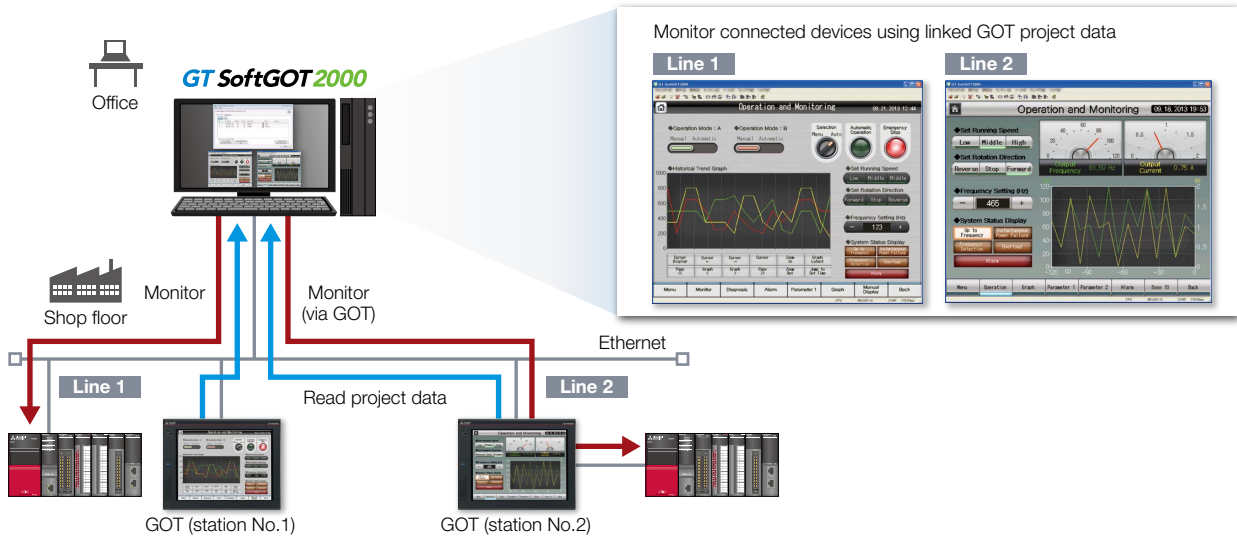

GT SoftGOT2000 Commander makes monitoring work efficient

When using the SoftGOT-GOT link function, GT SoftGOT2000 Commander can be used to collectively check the monitoring status of GT SoftGOT2000 modules, and start or stop monitoring of the modules.

* GT SoftGOT2000 Commander is a software included in GT Works3, the same as GT SoftGOT2000.

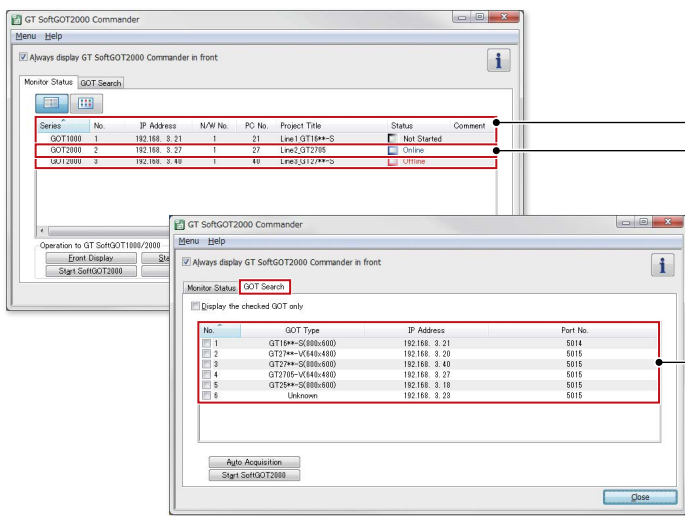

Effective usage when there are multiple GOTs that use the SoftGOT-GOT link function

The list shows which GT SoftGOT2000 module is linked to which GOT, and each monitoring status. Since it is recommended to use up to four modules of GT SoftGOT2000 online simultaneously, after starting up 20 modules of the software, up to four modules can be set online and thus large-scale systems can be monitored efficiently.

Managing start/stop of monitoring is easy

Double-click the Comment column of each line to switch between Online and Offline, or between Not started and Online (Offline).

- Online: during monitoring
- Offline: stopped monitoring

Automatically search for GOTs to monitor

GOTs that can use the SoftGOT-GOT link function can be searched.

Building advanced systems

Windows® applications can be started up from GT SoftGOT2000.

The data of GT SoftGOT2000 internal devices can be read and written from the user-created applications. Interaction between GT SoftGOT2000 and user-created applications enables the users to control or manage data by own method.

* GD, GS, GB, SGB, or SGD internal devices can be used.

* For the supported applications, please refer to the GT SoftGOT2000 Version1 Operating Manual.

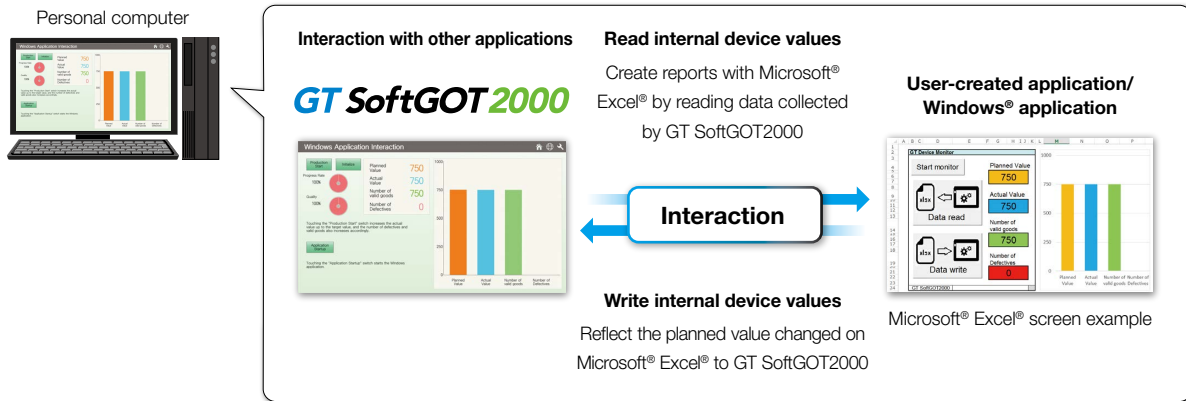

Starting up other applications with a touch switch on the GT SoftGOT2000 screen

By creating a touch switch on the GT SoftGOT2000 screen in advance, it is possible to start other applications (such as Microsoft® Excel®) while monitoring GT SoftGOT2000. In addition, by setting internal devices to the option for application startup, the mode or processing of the applications can be dynamically changed. **NEW** Interaction between equipment monitoring and personal computer applications makes monitoring work efficient.

Starting up Microsoft® Excel®

The data collected by GT SoftGOT2000 can be checked in a graph quickly.



Starting up GX Works3

MI3000 at the shop floor monitors sequence programs without bringing a laptop computer.

* GX Works3 should be installed in advance.

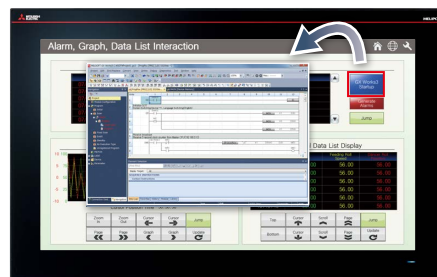

MI3000 with GT SoftGOT2000

► For the details of MI3000, see page 208.

Automatic startup

By using scripts, other applications can be started automatically by setting conditions such as when an error occurs or specific device values. (GS devices are used to control the function.)

Building a large scale remote monitoring system (GT SoftGOT2000 + GOT Mobile function) NEW

GT SoftGOT2000 that runs on a personal computer can be used as a server of the GOT Mobile function. It is easy to monitor multiple devices remotely from mobile terminals by accessing a panel computer on the equipment or a personal computer on the network. In addition, a large scale remote monitoring system can be built when using GT SoftGOT2000 that performs overall monitoring as the server of the GOT Mobile function.

* To use GT SoftGOT2000 with the GOT Mobile function, it is recommended to use GT SoftGOT2000 (multiple channels). The GOT Mobile function cannot be used with Windows® 7, Windows® 8.1 (no edition), or Windows® 10 Home edition.

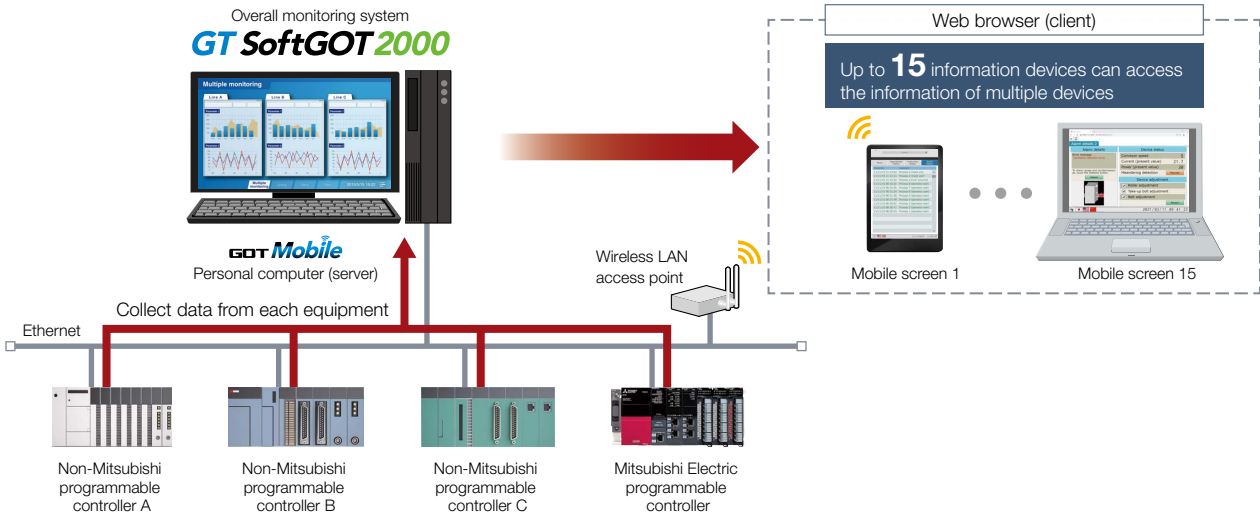

3 GT SoftGOT2000



Enhanced functions to implement a host monitoring system

The entire factory can be visualized by interacting with the ANDON function and the user alarm reception function of the Pocket GOT mobile app.

Interaction with the ANDON function

Information obtained from production equipment is displayed on the monitor for ANDON via GT SoftGOT2000, allowing sharing of the production site information to enable visualization.

GT SoftGOT2000

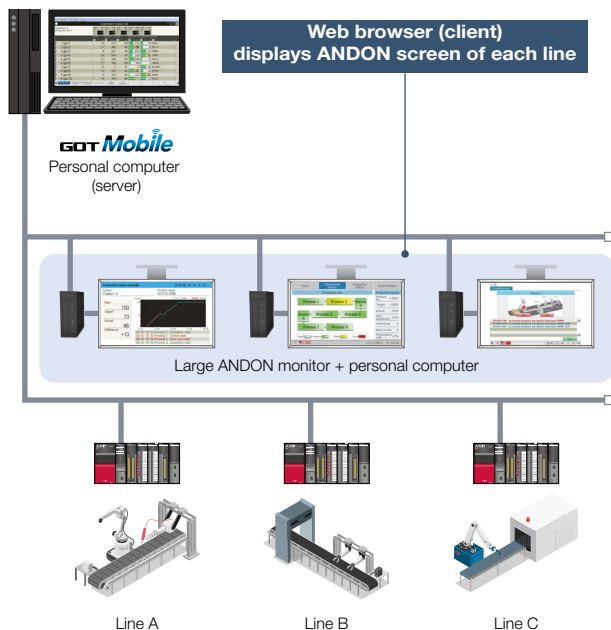

Interaction with the Pocket GOT mobile app user alarm reception function

Smartphones and mobile terminals can receive the information of user alarms in real time when they occurred on GT SoftGOT2000.

* For the details of the Pocket GOT mobile app user alarm reception function, please see page 38.

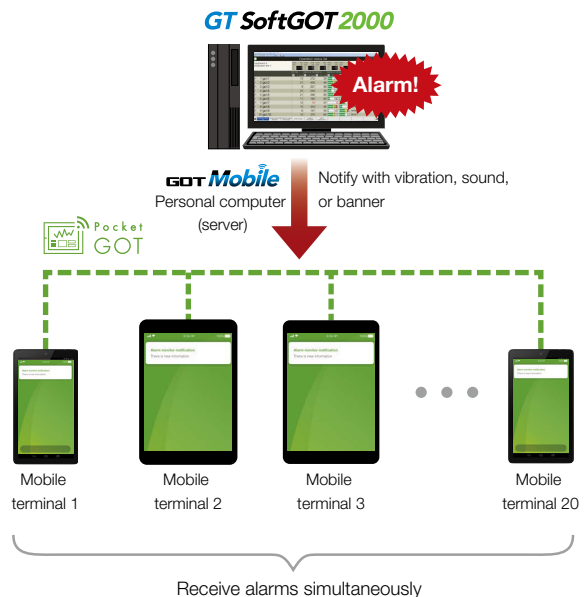

* The OS supported by Pocket GOT is Android™ only. When using the Pocket GOT mobile app with the GOT Mobile function, up to 20 information devices can be used.

Enhanced interaction with drive control (servo) system NEW

The SoftGOT2000 provides advanced functionality and improves connectivity with Mitsubishi servo systems. It provides some functions of MR Configurator2 (supporting MR-J5 and MR-J4). The status of servo amplifiers can be checked in your office or at the shop floor when they are connected to GT SoftGOT2000. Select the required connection type that matches your system configuration from various types of connection with servo amplifiers.

System configuration examples

GT SoftGOT2000
(Multi-channel)

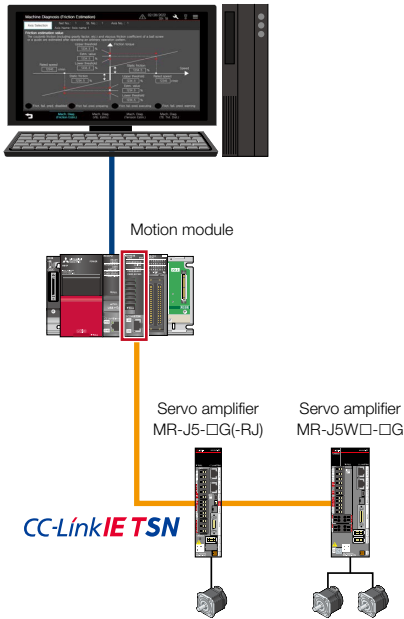

GT SoftGOT2000
(Multi-channel / Single-channel)

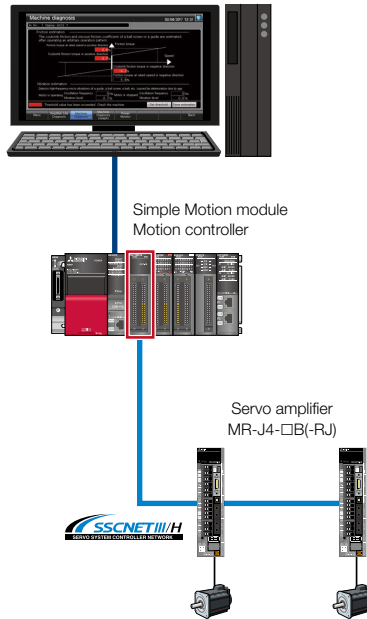

GT SoftGOT2000
(Multi-channel)

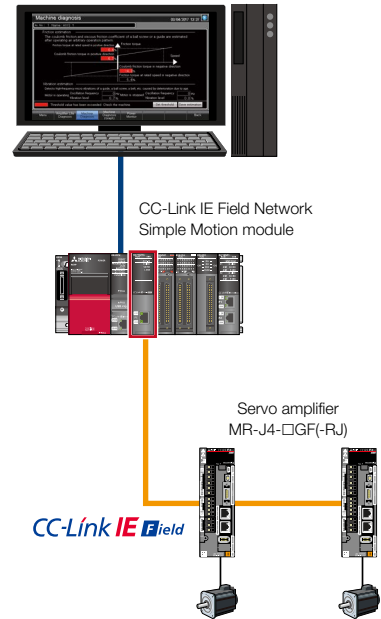

* For the details of supported connection types, supported models, and restrictions, please refer to page 52.

Enhanced interaction with drive control (inverter) system NEW

The SoftGOT2000 provides advanced functionality and improves connectivity with Mitsubishi inverter systems. It provides some functions of FR Configurator2. Select the required connection type that matches your system configuration from various types of connection with inverters.

System configuration examples

GT SoftGOT2000
(Multi-channel)

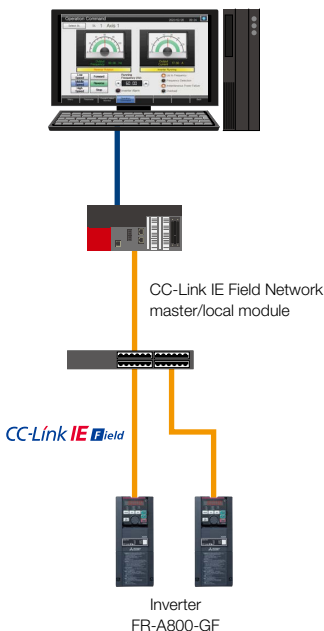

GT SoftGOT2000
(Multi-channel)

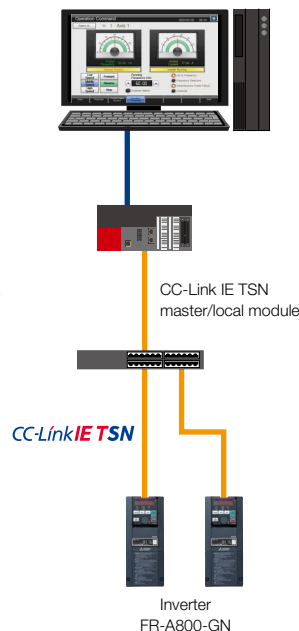

GT SoftGOT2000
(Multi-channel)

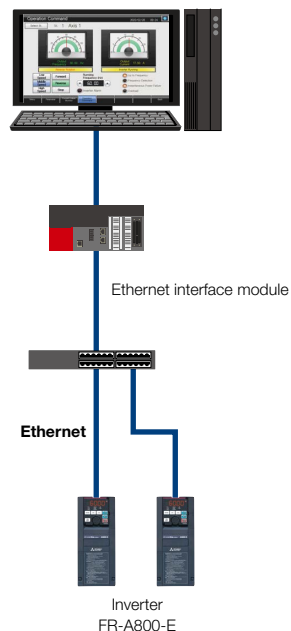

GT SoftGOT2000
(Multi-channel)

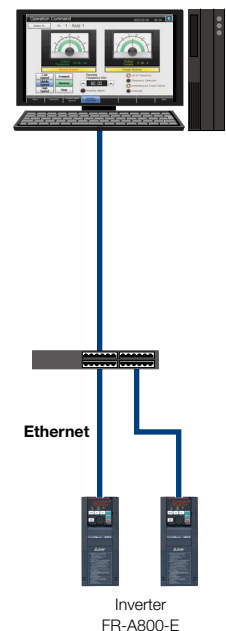

* For the details of supported connection types, supported models, and restrictions, please refer to page 68.

GOT Solutions INDEX

GOT2000
Graphic Operation Terminal



GOT Web-based Remote Solutions 34

• GOT Mobile function	Upgraded	36	• Pocket GOT mobile app: Working memo function	NEW	41
• GOT Mobile function (GT SoftGOT2000)	NEW	37	• iQ Monozukuri ANDON		42
• Pocket GOT mobile app: User alarm reception function	NEW	38	• VNC server function		43
• GOT Mobile function (placing a hyperlink on a mobile screen)		39	• SoftGOT-GOT link function		44
• iQ Monozukuri Process Remote Monitoring		40	• Remote personal computer operation function (Ethernet)	Upgraded	45

Video Interactive Solutions 46

• Multimedia function		47	• Camera link application	NEW	49
• Video display/RGB display/Video output function	Upgraded	48			

GOT Drive Control (Servo) Interactive Solutions 50

• Drive recorder function	Upgraded	54	• Power monitor		61
• Servo amplifier graph function	Upgraded	55	• Alarm display function	Upgraded	61
• Machine diagnosis function	Upgraded	56	• Servo amplifier monitor function		62
• MR-J5 sample screens	NEW	57	• Intelligent module monitor function		63
• Servo amplifier life diagnosis function	Upgraded	58	• R motion monitor function/ Q motion monitor function		63
• One-touch tuning function/Tuning function	Upgraded	59	• R motion SFC monitor function / Q motion SFC monitor function	NEW	64
• System launcher (servo network) function	Upgraded	60	• Motion program editor function		65
			• GOT Drive Plus (paid template screens)		66

GOT Drive Control (Inverter) Interactive Solutions 68

• Parameter settings (simple mode)/ Parameter recipe (simple backup/restoration)		70	• Machine diagnosis (load characteristics measurement)		72
• Batch monitor		71	• Inverter life diagnosis		73
• Operation command		71	• FA transparent		73

GOT Drive Control (Robot) Interactive Solutions 74

• Interactive functions to support startup and maintenance of robots		74
--	--	----

Sophisticated Programmable Controller Interactive Features 75

• Sample screens for live & PTZ cameras connected via the MELSEC iQ-R camera recorder module NEW	75	• Sequence program monitor (Ladder, iQ-R ladder, iQ-F ladder NEW) function	77
• Sequence program monitor (SFC) function	76	• FX list editor function & FX ladder monitor function	78
		• Log viewer function	79

Maintenance, Troubleshooting and Diagnostics Features 80

• Backup/Restoration function	80	• Device monitor function	84
• System launcher function Upgraded	81	• Network monitor function	84
• CC-Link IE TSN/ CC-Link IE Field Network diagnostics Upgraded	82	• Alarm function	85
• FA transparent function Upgraded	83	• Document display function	86
		• GOT diagnostics function	87

Hardware Features 88

• Compatible with environmental standards	88	• Sound output function	90
• Wireless LAN communication unit	89	• Panel Mount HMI Speaker NEW	91
• Ethernet communication unit	89	• Antibacterial/Antiviral Protective Sheet NEW	91

Security & Additional System Features 92

• Recipe function	92	• Printing hard copies and reports	99
• Recipe display (record list)	93	• Base screen size expansion	100
• Writing resource data	94	• Changing comments without using GT Designer3	101
• Various security functions	95	• Regarding FDA 21 CFR Part 11 support	102
• Operation log function	96	• GT Reporting Tool NEW	103
• Operator authentication function Upgraded	97	• Logging & Graph/List	104
• Network drive	98	• Gesture function	105

Data Handling Features 106

• MES interface function	106	• File transfer function	108
• File manager function	107		

Interactive Features with Other Industrial Devices 109

• Multi-channel function/ Device data transfer function	109	• e-F@ctory Starter Package (free of charge sample project) Upgraded	113
• Interaction function with CNCs	110	• Standard screen samples, Function samples	114
• GENESIS64™ interaction function (Gateway function) NEW	111	• Connection samples, iQSS related samples	115
• iQSS utility function Upgraded	112		

GOT Web-based Remote Solutions



Monitor your shop floor from a remote location

■ Can I check the equipment status from a remote location?

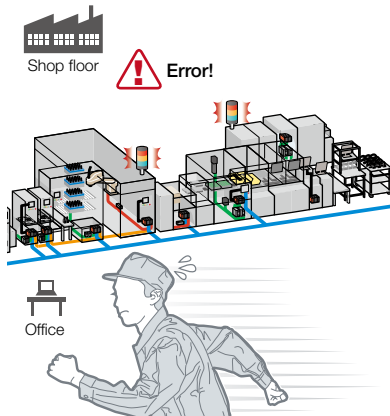

■ Can I check the situation without visiting the shop floor?

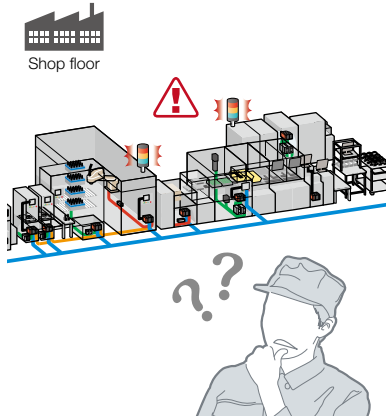

■ Can I share the information created on a mobile terminal?



GOT offers various remote monitoring and operation functions that can be used for various applications depending on your needs. The GOT remote solutions increase efficiency in various applications from startup, adjustment, to maintenance using mobile devices and personal computers. The GOT2000 improves visualization accessibility and reduces total cost of ownership.

■ Comparison of remote maintenance functions

Item	Monitor or operate GOT, GT SoftGOT2000, or connected devices from a personal computer or a mobile terminal						Monitor a personal computer from GOT	
	GOT Mobile function			iQ Monozukuri Process Remote Monitoring P.40	VNC server function P.43	SoftGOT-GOT link function P.44	Remote personal computer operation function (Ethernet) P.45	
	GT27/GT25 (server) P.36	GT SoftGOT2000 (server) NEW P.37	iQ Monozukuri ANDON P.42					
Number of simultaneous connections from clients	○ Maximum 5	○ Maximum 15*4	○ Maximum 5	—	× Simultaneous connection prohibited (1 to 1 only)	○ Maximum 7*1	—	
Monitor a different screen on each client	○			—	× Always monitor the same screen as on GOT	△ *2	—	
Drawing performance	○			○	△	○	—	
Viewing application	Web browser (Google Chrome™, Safari®, Microsoft Edge® NEW)			GT SoftGOT2000 (license key required separately)	VNC viewer (freeware*3)	GT SoftGOT2000 (license key required separately)	—	
Mobile application interaction (Android™ dedicated application, Pocket GOT)	User alarm reception function	User alarm reception function	—	Working memo function	—	—	—	
Required options	License (register on GOT)	License (register on GT SoftGOT2000)	License (register on GOT)	License (register on PC), License key (attach to PC)	License (register on GOT)	License key (attach to PC)	License (register on GOT)	
Authorization exclusive control	○						○	
Screen display	Supported objects (touch switch, etc.)	△ Some functions are different from GOT	△ Some functions are different from GOT	△ Some functions are different from GOT	○ Same as GOT	○ Same as GOT	○ Same as GOT	—
	Monitoring functions (sequence program monitor, etc.)	× Not supported			× Not supported	○ Same as GOT	× Not supported	—

*1 When using the GOT network interaction function, multiple clients can be connected simultaneously. Note that restrictions exist depending on the connection type between GOT and the connected device.

*2 When a GOT internal device is used as the screen switching device, each client can display a different screen.

*3 For the VNC client software that can be used, please refer to the Technical Bulletin GOT-A-0069 on the Mitsubishi Electric Factory Automation Global website (www.MitsubishiElectric.com/fa/).

*4 When using the Pocket GOT mobile app with the GOT Mobile function, up to 20 information devices can be used.

Safety precautions

When the GOT Mobile function, the VNC Server function, the SoftGOT-GOT link function, the remote personal computer operation function (Ethernet), or iQ Monozukuri products is used to perform remote control of control equipment, the field operator may not notice the remote control, possibly leading to an accident. In addition, a communication delay or interruption may occur depending on the network environment, and remote control of control equipment cannot be performed normally in some cases. Before using these functions to perform remote control, fully grasp the circumstances of the field site and ensure safety.

Use GOT remote functions effectively in your shop floor

- Monitor and operate GOT from multiple remote locations**
 - GOT Mobile function 36
 - SoftGOT-GOT link function 44

- Check the user alarms on a mobile terminal**
 - Pocket GOT mobile app: User alarm reception function **NEW** 38

- Share the information of the shop floor**
 - Pocket GOT mobile app: Working memo function **NEW** 41

- Implement the ANDON system easily**
 - GOT Mobile function 36
 - iQ Monozukuri ANDON 42

- Check the data in a PC in your office from the shop floor**
 - Remote personal computer operation function (Ethernet) 45

- Monitor GOT at high speed**
 - GOT Mobile function 36
 - SoftGOT-GOT link function 44

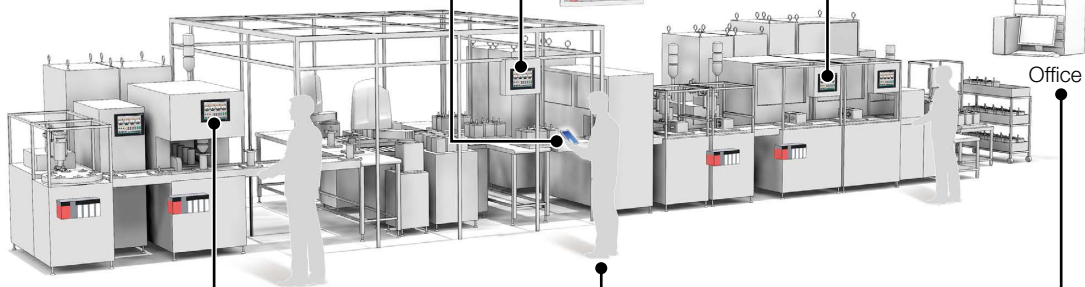

- Create remote monitoring screens without extra efforts**
 - VNC server function 43
 - SoftGOT-GOT link function 44

- Use various monitoring functions remotely (sequence program monitor, etc.)**
 - VNC server function 43

- Monitor and operate GOT using different screens depending on the information device**
 - GOT Mobile function 36



- Check the shop floor image using a web browser**
 - GOT Mobile function (placing a hyperlink on a mobile screen) 39

- Monitor the entire factory from remote locations**
 - GOT Mobile function (setting GT SoftGOT2000 as a server) **NEW** 37

- Manage information of multiple devices**
 - iQ Monozukuri Process Remote Monitoring 40

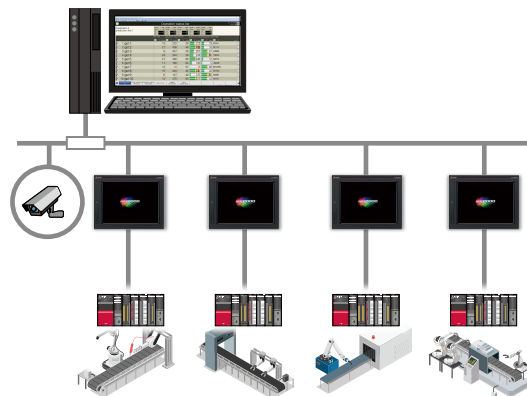

Monitor your shop floor from a remote location

Upgraded

GOT Mobile function (setting GT27/GT25 as a server)



4

GOT Solutions - GOT Web-based Remote Solutions



Can I check the equipment status from a remote location?

Function features

Via GOT at the shop floor, connected devices can be monitored from computers and tablets in a remote location.

* A separate license (GT25-WEBSKEY-□) is required.

Safe with security and exclusive control

Exclusive control of authorization prevents accidents that might be caused by simultaneous operations in the same network. (GOT network interaction*1)

Set passwords to control monitoring and operation. *1 For the details, please refer to page 44.

GOT2000 Series
GOT Mobile Function
Application Examples
(L(NA)08464ENG).



GOT will solve your problems!

Check the status of the shop floor using a web browser.

Outside of the clean room

From a remote location

From your office

Other usage

On a large screen

Up to five operators

Monitor production with one PC

Check the equipment status using a web browser on tablets from a remote location. Up to five information devices can simultaneously access a single GOT so that you can view and operate a different screen on each device.

* Up to five clients can connect to one GOT at the same time.

* A web browser (Google Chrome™, Safari®, or Microsoft Edge® **NEW**) is required on information devices.

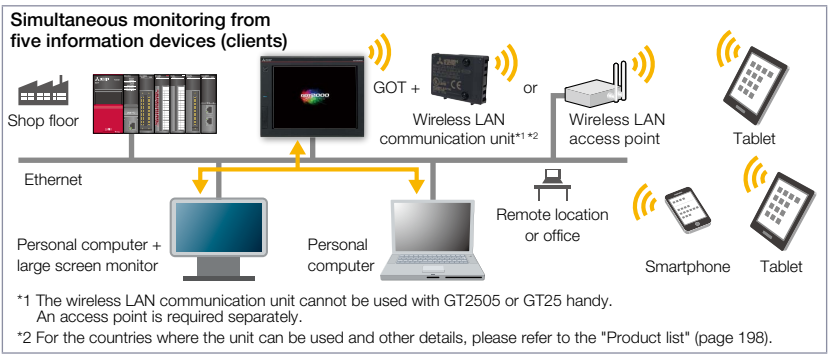

Flexibly design screens depending on the device

* Maximum 3000 x 3000 dots

Smartphone size

Tablet size

PC size

Full HD size

Specification details and restrictions

* For the necessary option devices, please refer to the "Function list" (page 166).

- **Validated devices and environments of the GOT Mobile function** For the details, please contact your local sales office.
- **Objects, figures, functions that can be used with the GOT Mobile function** There are some restrictions on the objects, figures, and functions that can be used on information devices such as tablets. For the details, please refer to the relevant product manual.
- **Precautions for the GOT Mobile function** Please refer to the Technical Bulletin No. GOT-A-0090 on the Mitsubishi Electric Factory Automation Global website (www.MitsubishiElectric.com/fa/).
- **Peripheral devices** For the VPN connection and the peripheral devices compatible with other Mitsubishi industrial devices, please contact your local sales office.

Recommended industries

- Automotive
- SEMICON, LCD
- Electronics
- F & B
- Pharma
- Plant

Supported GOT types

- GT27
- GT25
- GT23
- GT21
- GS21
- SoftGOT

Supported devices

- PLC
- Servo
- Inverter
- Robot
- CNC

Monitor the entire factory from a remote location

GT SoftGOT2000 + GOT Mobile



Support system operation

NEW

GOT Mobile function (setting GT SoftGOT2000 as a server)

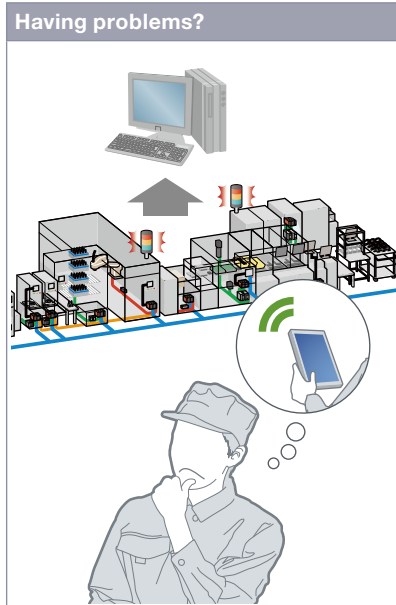

GOT will solve your problems!

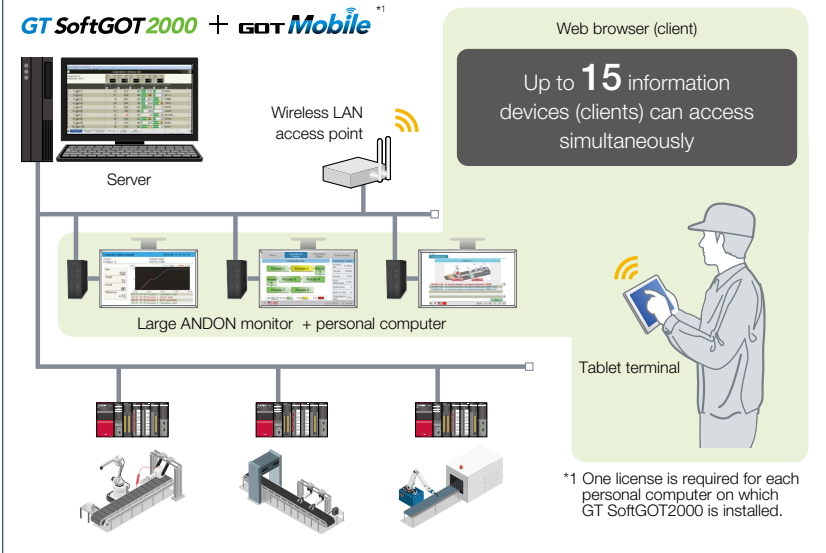

Is there any way to collectively monitor the information separately stored in each device? How can I check the collected data on a mobile terminal?

Function features

Via GT SoftGOT2000, connected devices can be monitored from information devices such as tablets. By using the GOT Mobile function on GT SoftGOT2000, it is possible to build a larger monitoring system and collectively monitor the information.

* A separate license (SGT2K-WEBSKEY-□) is required.

The GOT Mobile function can be added to the overall monitoring system that utilizes GT SoftGOT2000 in order to setup multiple ANDON monitors, monitor the shop floor from your office, and visualize the entire factory. The equipment status can also be checked on mobile terminals so that you can perform maintenance work smoothly.

System configuration example

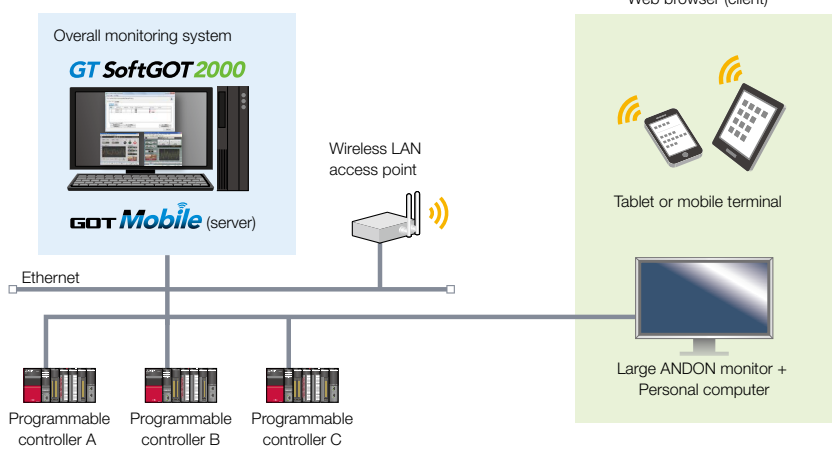

Using with the GOT Mobile function (setting GT27 or GT25 as a server)

Just by switching the GOT Mobile connection destination server, it is easy to switch monitoring targets between the overall monitoring system monitored by GT SoftGOT2000 and the status of equipment connected to GOT.

For the details, please refer to the GOT2000 NEWS Vol.17 (L(NA)08822ENG).



Specification details and restrictions

- **Using GT SoftGOT2000 with the GOT Mobile function** It is recommended to use GT SoftGOT2000 (multiple channels). The GOT Mobile function cannot be used with Windows® 7, Windows® 8.1 (no edition), or Windows® 10 Home edition.
- **Precautions when using the Pocket GOT mobile app with the GOT Mobile function** The maximum number of connectable devices are 15 for the GOT Mobile function and 20 for the Pocket GOT mobile app. However, when using these function and the app together, the maximum number of connectable devices is 20. Example: total of 20 devices including 15 devices for the GOT Mobile function and 5 devices for the Pocket GOT mobile app

Recommended industries

Automotive	SEMICON, LCD	Electronics
F & B	Pharma	Plant

Supported GOT types

GT27	GT25	GT23
GT21	GS21	SoftGOT

Supported devices

PLC	Servo	Inverter
	Robot	CNC

Notify the user alarm to a mobile terminal



■ **Pocket GOT mobile app: User alarm reception function** NEW
 (Interaction function with the GOT Mobile function)

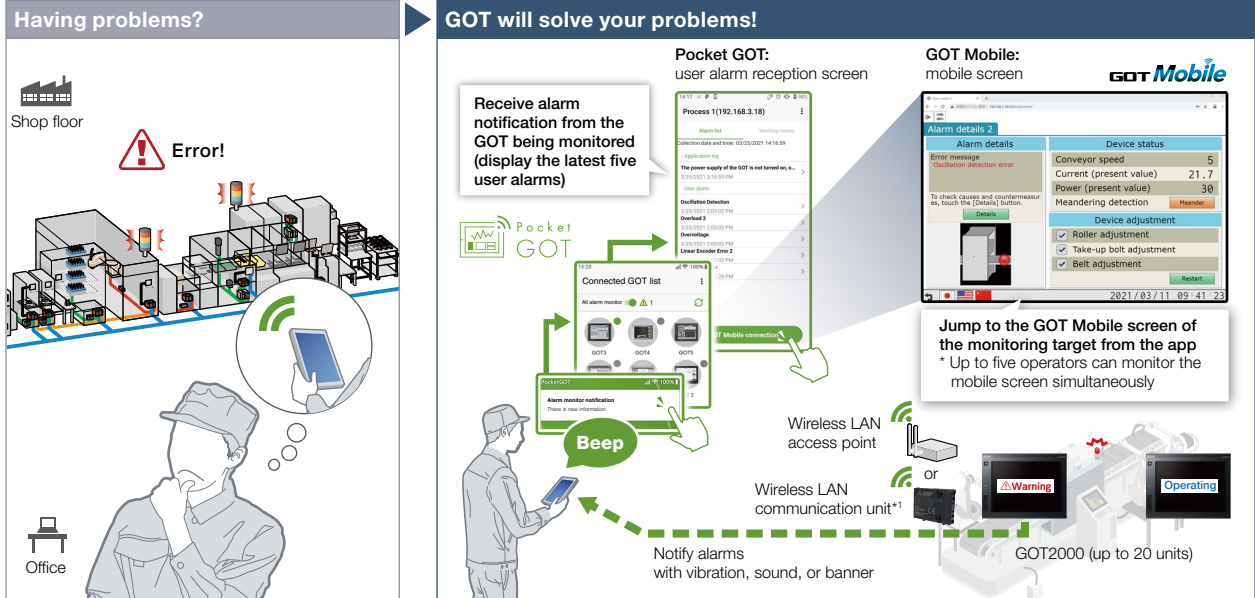

How can I check the problem occurred in the shop floor quickly?

With the user alarm reception function of Pocket GOT, a mobile terminal can receive the alarm notification when a user alarm occurred in the shop floor.

*1 The wireless LAN communication unit cannot be used with GT2505, GT25 handy, or a personal computer where GT SoftGOT2000 is installed. An access point is required separately.

Function features

By installing the Pocket GOT mobile app on a mobile terminal, the app collects the status of user alarms occurring in the monitored GOT and notifies you with vibration, sound, or banner when a new alarm is detected. On the user alarm reception screen of Pocket GOT, you can check a list of the latest five alarms that are currently occurring. Pocket GOT can register up to 20 GOTs. The status of the GOT where the user alarm has occurred can be checked on the mobile terminal by starting the GOT Mobile function from the user alarm reception screen.

Usage

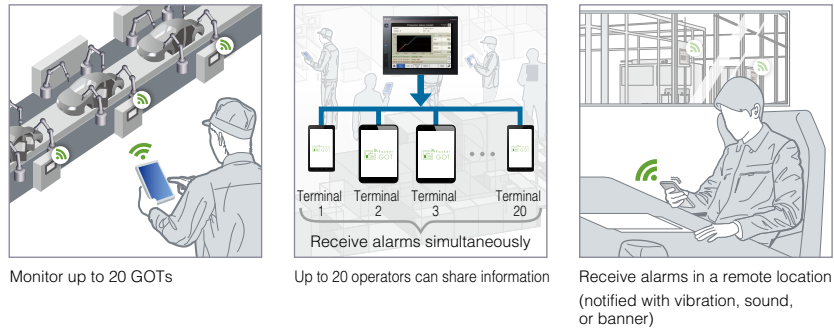

For the details, please refer to the GOT2000 NEWS Vol.16 (L(NA)08808ENG).



Specification details and restrictions

- OS supported by Pocket GOT Android™
- Precautions for the Pocket GOT mobile app Please refer to the Pocket GOT Operating Manual (SH(NA)-082512ENG) on the Mitsubishi Electric Factory Automation Global website (www.MitsubishiElectric.com/fa/).
- Precautions when using the wireless LAN communication unit with Pocket GOT When using the wireless LAN communication unit on GOT, up to 5 mobile terminals can receive alarms from a single GOT simultaneously. To enable 20 mobile terminals to receive alarms from a single GOT, it is required to use a wireless LAN router.
- Precautions when using the Pocket GOT mobile app with the GOT Mobile function (setting GT SoftGOT2000 as a server) Up to 20 information devices can be used. For the details, please refer to page 37.

Recommended industries



Supported GOT types



Supported devices



Check the shop floor image using a web browser



Support system operation

■ GOT Mobile function (placing a hyperlink on a mobile screen)



Production line has stopped due to machine errors! Can I check the image of the shop floor?

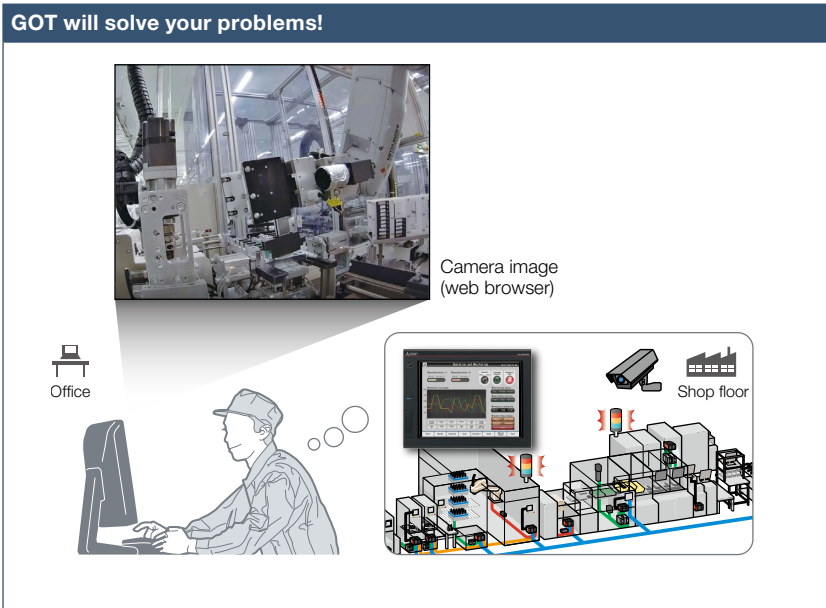

By using the GOT Mobile function, the shop floor can be checked with video. It is easy to check live camera images and recorded files in a network camera by using a web browser on a personal computer or a tablet.

* Supported web browsers are Google Chrome™, Safari®, and Microsoft Edge® **NEW**

Function features

Start a web browser on a personal computer or a tablet using the GOT Mobile function, and check live camera images and video feeds saved in a network camera on the browser. It is easy to access cameras without remembering their IP addresses by setting them on a mobile screen in advance.

* To use mobile screens, the GOT Mobile function license (GT25-WEBSKEY-□ or SGT2K-WEBSKEY-□) is required separately.

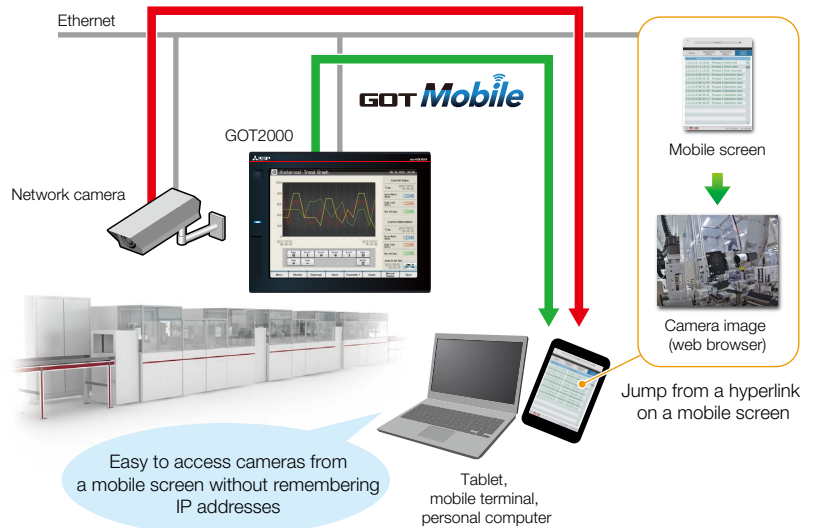

Recommended industries

Automotive	SEMICON, LCD	Electronics
F & B	Pharma	Plant

Supported GOT types

GT27	GT25	GT23
GT21	GS21	SoftGOT

Supported devices

PLC	Servo	Inverter
	Robot	CNC

Easily monitor multiple devices from a remote office



■ iQ Monozukuri Process Remote Monitoring

Having problems?

Third-party company programmable controller A

Mitsubishi Electric programmable controller

Third-party company programmable controller B

GOT will solve your problems!

Personal computer or MELIPC MI3000

Collected data is displayed in a list or chart

Camera and on-site GOT images are displayed

HUB

Equipment 1, Equipment 2, ..., Equipment 50

Network camera

How can I effectively use the information separately stored in each device?

Manufacturing process and productivity of the whole production can be improved by analyzing the data aggregated and visualized on GT SoftGOT2000. The operation status of the shop floor and the information such as operation logs and alarms can be collected from each equipment via an on-site GOT.

Function features

IoT technologies can be easily introduced to the shop floor, and the information of multiple equipment can be collected, visualized, and managed collectively. The template project for GT SoftGOT2000 makes it easy to startup systems. In addition, a dedicated setting tool (Process Remote Monitoring setting tool) can be used to collectively manage (read/edit/write) the information of operators registered on on-site GOTs.



For more details, please refer to the iQ Monozukuri Process Remote Monitoring catalog (L(NA)08674ENG).

Displaying graphs

Displaying efficiency visually

GT SoftGOT 2000

Displaying a list

Process Remote Monitoring setting tool

Collecting information from on-site GOTs

Writing data to on-site GOTs

Up to 50 GOTs*1

*1 Up to five GOTs can be managed for each license. To manage information of 50 GOTs, purchase the product including 10 licenses.

Recommended industries

Automotive	SEMICON, LCD	Electronics
F & B	Pharma	Plant

Supported GOT types

GT27	GT25	GT23
GT21*	GS21	SoftGOT

Supported devices

PLC	Servo	Inverter
	Robot	CNC

* Supported only by the models equipped with an Ethernet port.

Share the information of the shop floor with pictures and text



Support system operation

■ Pocket GOT mobile app: Working memo function **NEW** (Interaction function with the iQ Monozukuri Process Remote Monitoring)

Having problems?

Shop floor

Error!

GOT will solve your problems!

Pocket GOT: working memo screen

Share information using Process Remote Monitoring

Process Remote Monitoring: working memo check screen

Enter working memos on mobile terminal

GT SoftGOT 2000

*1 The wireless LAN communication unit cannot be used with GT2505, GT25 handy, GT23, GT21, or GS21.

How can I share the information of errors and daily inspection results easily?

Use a mobile terminal to take pictures of the shop floor and create a working memo with text. The information such as the daily check results and error handling results can be computerized, automatically collected, and collectively managed.

Function features

By installing the Pocket GOT mobile app on a mobile terminal, working memos can be created to share the information such as the daily check results of on-site equipment and the status report at the error occurrence. The working memos can save text, pictures taken, and images saved in the mobile terminal. The created working memos can be sent and saved to the connected GOT. iQ Monozukuri Process Remote Monitoring collects the working memos saved in the GOT, allowing you to check them collectively on a personal computer and to create reports for each date, time, and place.

* Supported by GT2107-WTBD, GT2107-WTSD, GT2104-RTBD, and GT2103-PMBD among GT21 models.

Usage

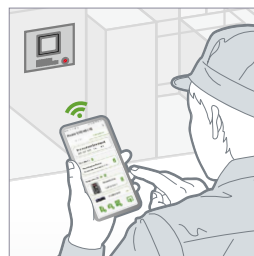

Send work reports to GOT



Take pictures of the equipment or the GOT screen and send them to GOT



Work reports and equipment pictures saved in multiple (up to 50) GOTs can be displayed collectively on a PC for data management

For the details, please refer to the GOT2000 NEWS Vol.16 (L(NA)08808ENG).



Specification details and restrictions

- OS supported by Pocket GOT Android™
- Precautions for the Pocket GOT mobile app Please refer to the Pocket GOT Operating Manual (SH(NA)-082512ENG) on the Mitsubishi Electric Factory Automation Global website (www.MitsubishiElectric.com/fa/).

Recommended industries

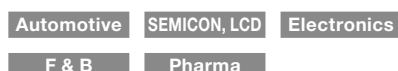

Supported GOT types



Supported devices



* Excluding some models. For the details, refer to the function descriptions above.

Implement the ANDON system easily



iQ Monozukuri ANDON

Having problems?

GOT will solve your problems!

Can I implement the ANDON system at low cost and visualize the shop floor?

iQ Monozukuri ANDON is a simple ANDON* package that easily enables visualization of shop floor using GOT2000 and a general-purpose web browser. Information obtained from production equipment is displayed on the monitor for ANDON via GOT2000, allowing sharing of the shop floor information to enable visualization.

* ANDON system visualizes information (production status, alarms) that is obtained from production equipment, sharing the information among site workers, a manager, and a maintenance personnel.

Function features

If you have equipment that can be connected to GOT2000, an ANDON system can be configured easily. The dedicated setting tool (Contents Publisher) allows you to set/change the display of ANDON screens even without programming knowledge for configuring the ANDON system. * iQ Monozukuri ANDON package is required separately.

Monitoring multiple devices with DB (database) mode

The production information of multiple lines is collected in real-time in ANDON DB (database), and displayed on the ANDON monitor by transferring the data via GOT.

Concept movie



For more details, please refer to the iQ Monozukuri ANDON catalog (L(NA)08487ENG).

System configuration example*1

iQ Monozukuri ANDON package*2

- 1 Contents Publisher
- 2 Project file of the GOT for iQ Monozukuri ANDON (template screens)
- 3 GOT Mobile function license
- 4 License for iQ Monozukuri ANDON

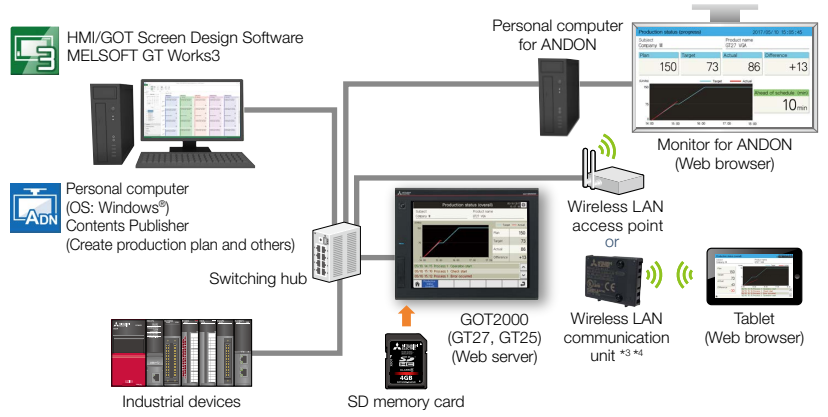

*1 The system configuration of the DB (database) mode differs from this example. For the details, please refer to the catalog on the left.

*2 Used by transferring to a personal computer, GOT2000 or an SD memory card.

*3 The wireless LAN communication unit cannot be used with GT2505 or GT25 handy.

An access point is required separately.

*4 For the countries where the unit can be used and other details, please refer to the "Product list" (page 198).

Recommended industries

Automotive	SEMICON, LCD	Electronics
F & B	Pharma	Plant

Supported GOT types

GT27	GT25	GT23
GT21	GS21	SoftGOT

Supported devices

PLC	Servo	Inverter
Robot	CNC	

Operate the GOT from a remote PC or tablet



VNC server function



A problem occurred at the shop floor in a remote location. Can I check the situation without visiting the shop floor?

Function features

Remotely view and operate the GOT screen from information devices such as a personal computer and tablet. No dedicated screens are required.

* A separate license (GT25-VNCSKEY) is required.

Same operations as GOT

Utility functions including the sequence program monitor and the network monitor are also supported on computers and tablets.

Safe with security and exclusive control

Exclusive control of authorization prevents accidents that might be caused by simultaneous operations in the same network. (GOT network interaction*) Set passwords to control monitoring and operation. * For the details, please refer to page 44.

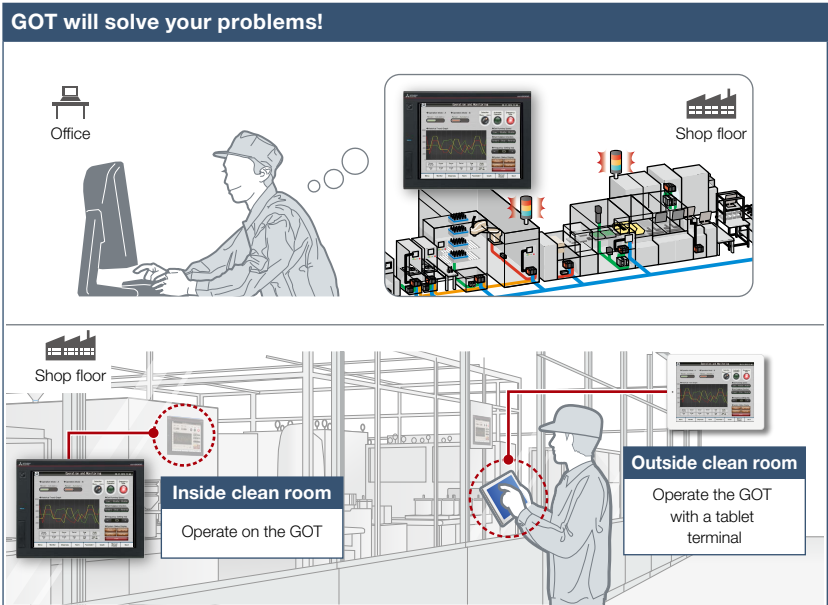

You do not need to visit the shop floor. Monitor and operate the GOT from a remote location, and you can take corrective actions quickly.

* One client can connect to one GOT at the same time.

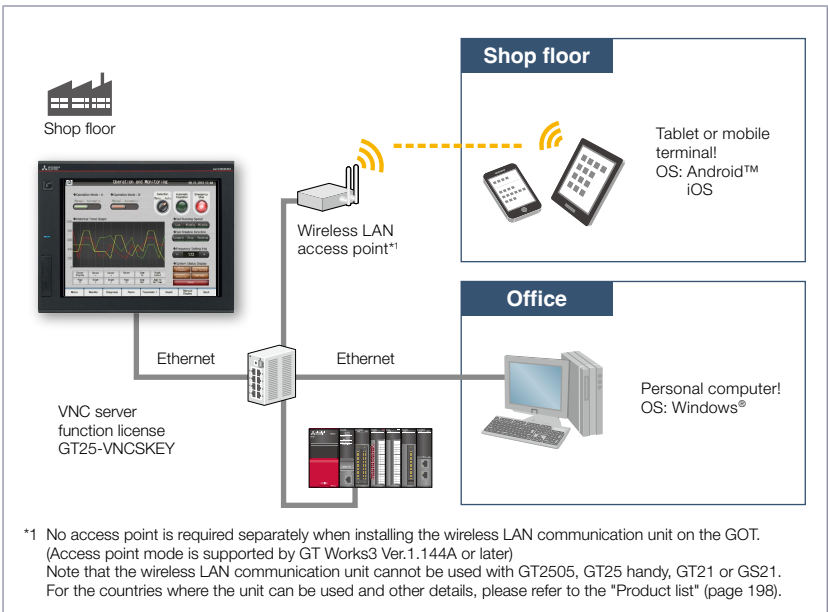

Specification details and restrictions

* For the necessary option devices, please refer to the "Function list" (page 166).

● **Applicable VNC client software** Please refer to the Technical Bulletin No. GOT-A-0069 on the Mitsubishi Electric Factory Automation Global website (www.MitsubishiElectric.com/fa/).

● **Peripheral devices** For the VPN connection and the peripheral devices compatible with other Mitsubishi Electric industrial devices, please contact your local sales office.

Recommended industries

Automotive	SEMICON, LCD	Electronics
F & B	Pharma	Plant

Supported GOT types

GT27	GT25	GT23
GT21*	GS21	SoftGOT

Supported devices

PLC	Servo	Inverter
	Robot	CNC

* GT2107-W only. For the details, refer to the function descriptions above.

Remote monitoring with SoftGOT



SoftGOT-GOT link function

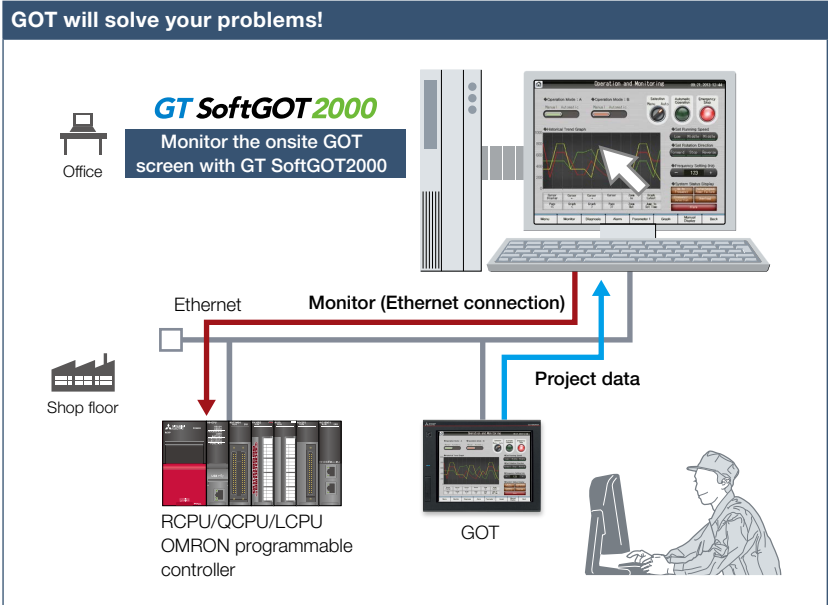
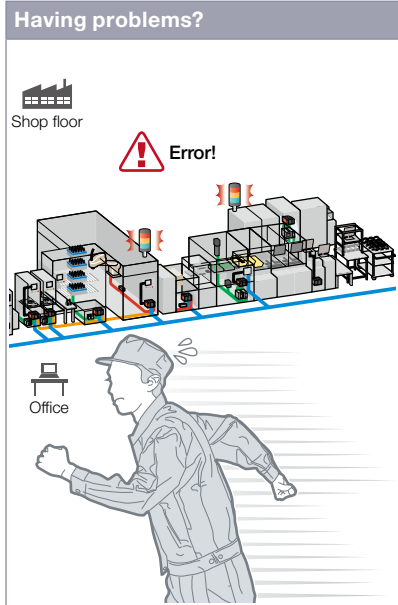

A problem occurred at the shop floor. Can I check the situation in my office?

Without creating screens for remote monitoring, check the shop floor on GT SoftGOT2000 by reading project data from GOT at the shop floor.

Function features

Read project data from the GOT connected to GT SoftGOT2000 via Ethernet, and you can monitor the devices that are connected to the GOT on different screens from the one shown on the GOT.

* A separate license key (GT27-SGTKEY-U) is required.

Safe with security and exclusive control

Exclusive control of authorization prevents accidents that might be caused by simultaneous operations in the same network. The exclusive control can be enabled/disabled for each screen. (GOT network interaction)

Set passwords to the GOT project data and prevent invalid access.

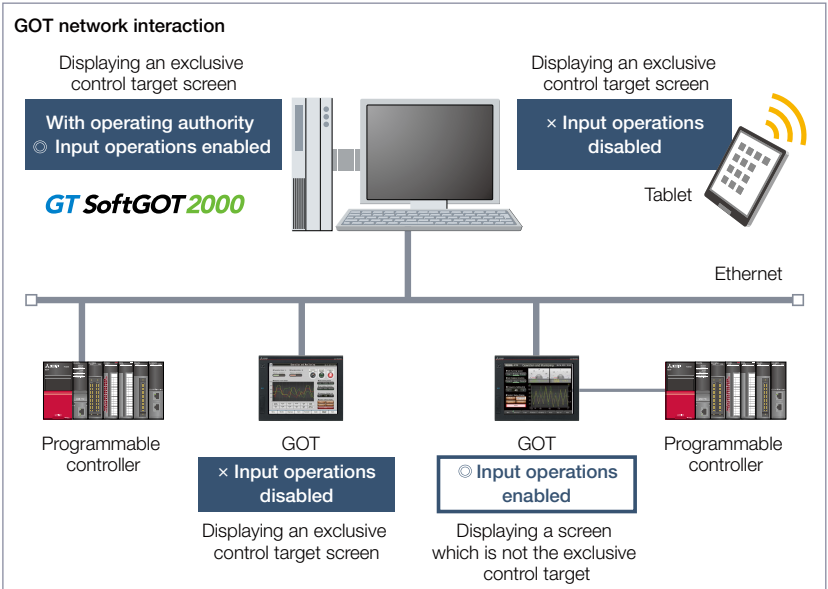

Specification details and restrictions

* For the necessary option devices, please refer to the "Function list" (page 166).

- **Supported devices and connection types** The devices supported by the SoftGOT-GOT link function varies depending on the connection types. For the details, please refer to the relevant product manual.
- **Functions that can be used in GT SoftGOT2000** In GT SoftGOT2000, some functions available in GOT2000 series cannot be used. For the details, please refer to the relevant product manual.

Recommended industries

Automotive	SEMICON, LCD	Electronics
F & B	Pharma	Plant

Supported GOT types

GT27	GT25	GT23
GT21	GS21	SoftGOT

Supported devices

PLC	Servo	Inverter
	Robot	CNC

Operate the PC from a remote GOT



Upgraded

Remote personal computer operation function (Ethernet)

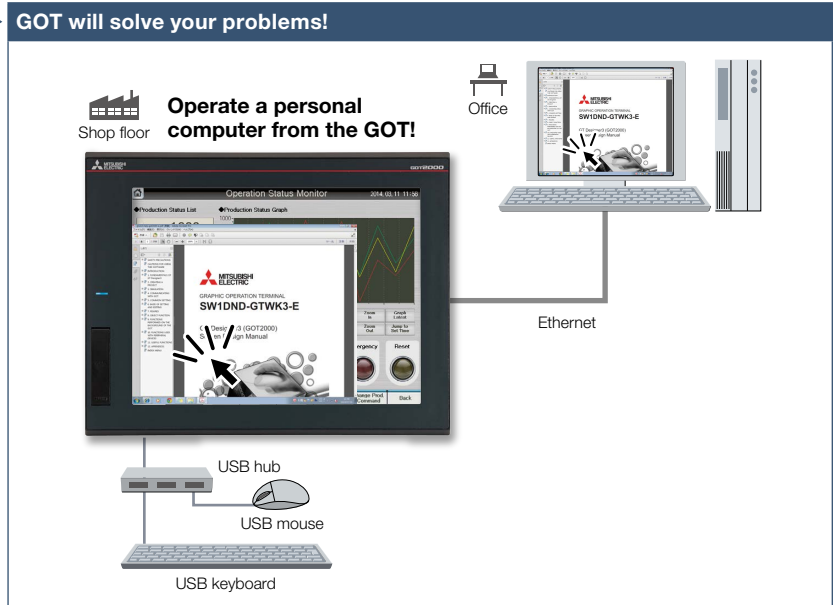
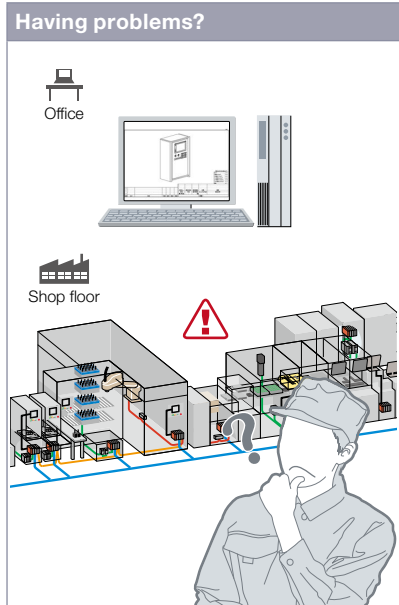

How can I view manuals and drawings in a personal computer in my office from the shop floor?

On GOT at the shop floor, you can operate a personal computer in a remote location and view manuals and drawings in the computer. Connecting a USB mouse/keyboard to the front (or rear) USB interface makes it easier to operate the personal computer.

Function features

Connect GOT at the shop floor to a personal computer in a remote location via Ethernet. This allows you to remotely operate the personal computer and view manuals and access the web browser on the computer*1.

The screen of a personal computer, which is playing back a video feed, can be displayed on GOT by setting the remote personal computer operation function license (paid) on the GOT.*1 In addition, if a setting application is built in a camera, adjustment (such as zoom and rotation) can be done and the camera can be operated from a personal computer on the network.

*1 A separate license (GT25-PCRAKEY-□) is required.

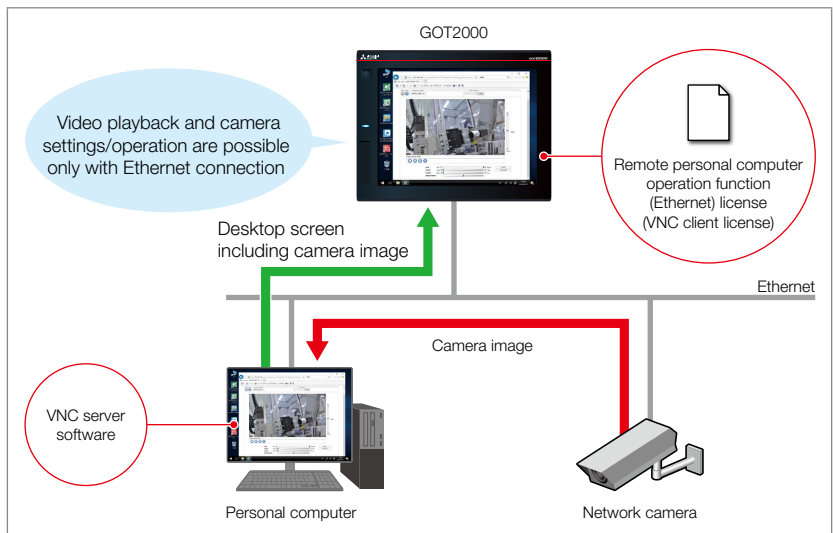

Specification details and restrictions

* For the necessary option devices, please refer to the "Function list" (page 166).

● **Validated VNC server** Please refer to the Technical Bulletin No. GOT-A-0110 on the Mitsubishi Electric Factory Automation Global website (www.MitsubishiElectric.com/fa/).

Recommended industries

Electronics F & B Plant

Supported GOT types

GT27 GT25 GT23
GT21 GS21 SoftGOT

Supported devices

PLC Servo Inverter
Robot CNC

Video Interactive Solutions

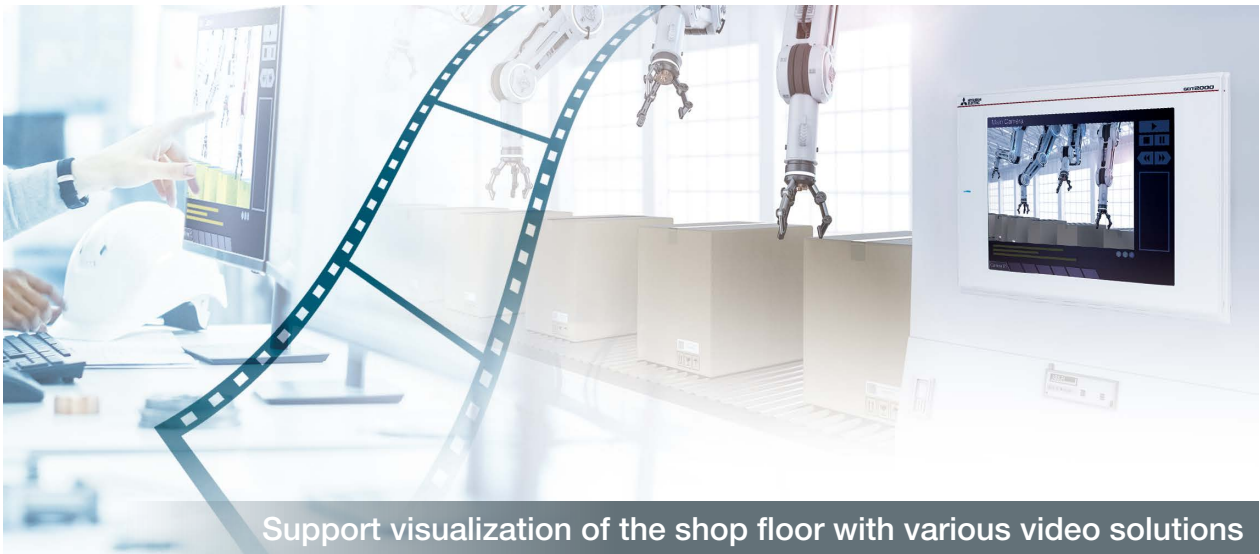

Support visualization of the shop floor with various video solutions

The GOT2000 Series provides various solutions using video to meet the needs on the shop floor such as checking video feeds from a remote location and saving camera images before and after an error occurrence.

■ Comparison of video interactive solutions

Item	Display images from a video camera or a PC on GOT			Output images to an external display from GOT		Operate a network camera and record images with GT SoftGOT2000
	Multimedia function P.47	Video display function P.48	RGB display function P.48	Video output function		Camera link application NEW
				RGB output P.48	HDMI output P.48	P.49
Number of connectable devices	One multimedia device per GOT unit	Four video devices per GOT unit	Two RGB output devices* per GOT unit * One device per GT27-V4R1-Z	One display per GOT unit	One display per GOT unit	One camera per PC
Display camera image on GOT	○	○	—	—	—	— (Display with an application)
Record camera image on GOT	○	× Not supported	—	—	—	—
Play camera image on GOT	○	× Not supported	—	—	—	— (Play on GX VideoViewer)
Display PC screen on GOT	—	—	○	—	—	—
Operate PC from GOT	—	—	○* * PC remote operation driver is required	—	—	—
Display separate screen from GOT	—	—	—	○ NEW	○ NEW	—
Record at an error occurrence	○	—	—	—	—	○ GT SoftGOT2000 detects an alarm and records camera image
Required option	Multimedia unit (GT27-MMR-Z), CF card	Video input unit (GT27-V4-Z) or Video/RGB input unit (GT27-V4R1-Z)	RGB input unit (GT27-R2)* ¹ or Video/RGB input unit (GT27-V4R1-Z)	RGB output unit (GT27-ROUT)	Digital video output unit (GT27-VHOUT)	GT SoftGOT2000 License Key (GT27-SGTKEY-U)

*1 When using GT27-R2, the RGB display function cannot be used to display the RGB screen.

Record/Playback videos to see what happened at shop floor



Multimedia function

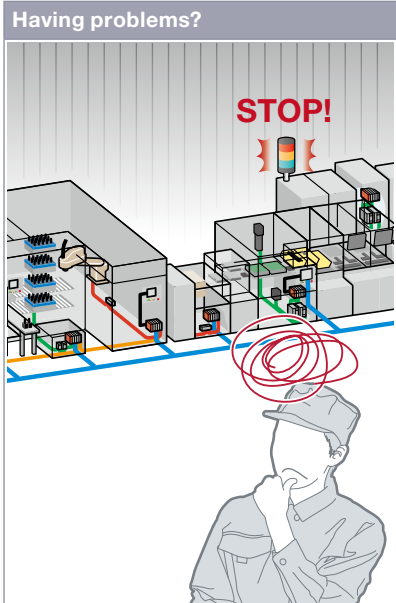

Production line has stopped due to machine errors! It's difficult to identify the cause of the error on the unattended line.

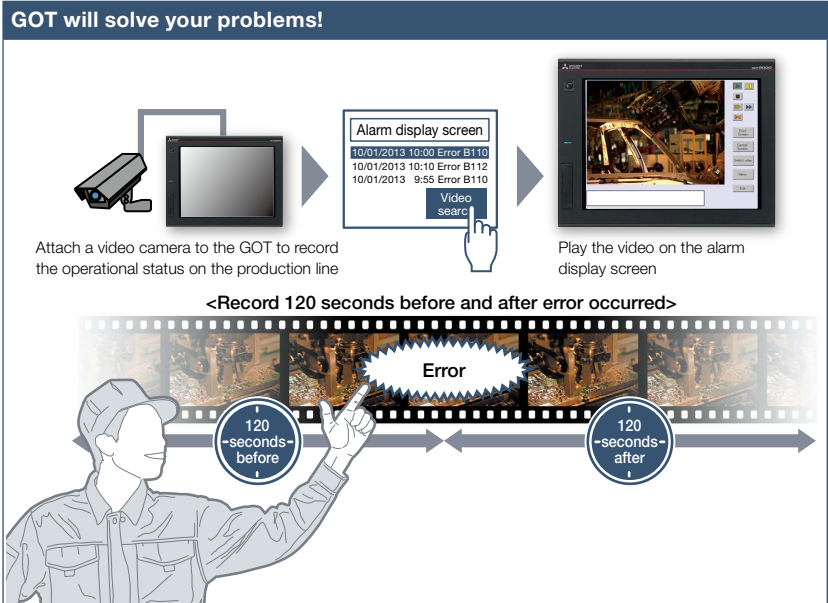

GOT records the operational status on the production line and plays back the recorded video image. Visual clarity of the image helps you to analyze the cause of the error.

Function features

GOT displays and records the image taken by a video camera connected to the multimedia unit and plays back the saved video image.

To set the timing of recording, you can use a device of a controller as a trigger.

* Multimedia unit (GT27-MMR-Z) and CF card are required.

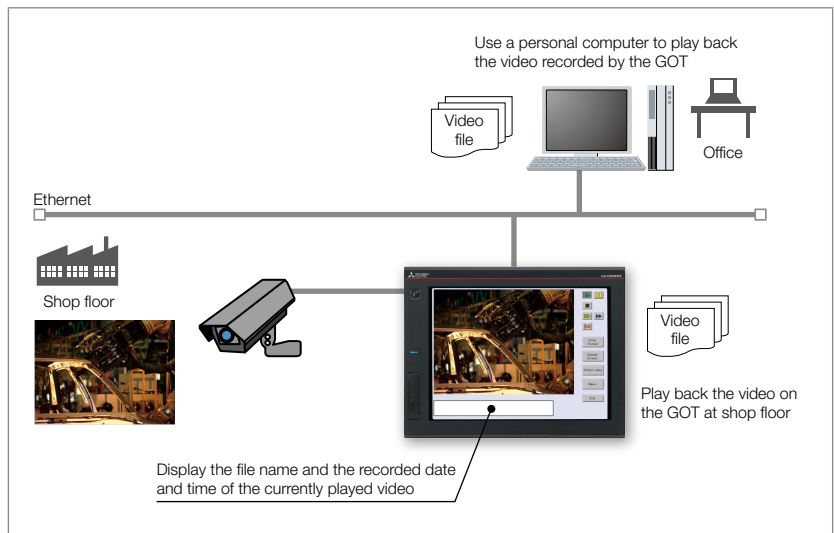

Specification details and restrictions

* For the necessary option devices, please refer to the "Function list" (page 166).

Recording specifications

Before-after event recording This allows the recording of a total of 240 seconds of images, including 120 seconds before and after a system error occurs. (When event trigger device turns on).

Standard mode This allows two types of recording modes: Recording size VGA (640 × 480), frame rate maximum 15fps; Recording size QVGA (320 × 240), frame rate maximum 30fps.

Long-time mode This allows the recording for long hours of approximately two days. Recording size QVGA (320 × 240), frame rate 15fps.

Unit installation One of the following units can be installed: multimedia unit, video input unit, digital video output unit, RGB input unit, video/RGB input unit, or RGB output unit.

Recommended industries

- Automotive
- SEMICON, LCD
- Electronics
- F & B
- Pharma

Supported GOT types

- GT27*
- GT25
- GT23
- GT21
- GS21
- SoftGOT

* Excluding GT2705.

Supported devices

- PLC
- Servo
- Inverter
- Robot
- CNC

Monitor shop floor using video images



Upgraded

Video display/RGB display/Video output function

4

GOT Solutions - Video Interactive Solutions

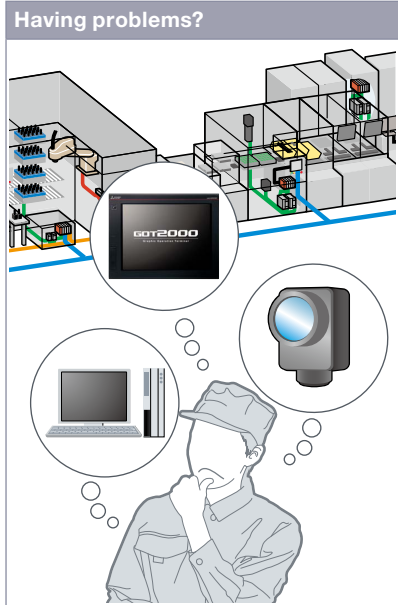

There is not enough space for multiple monitors at the shop floor.

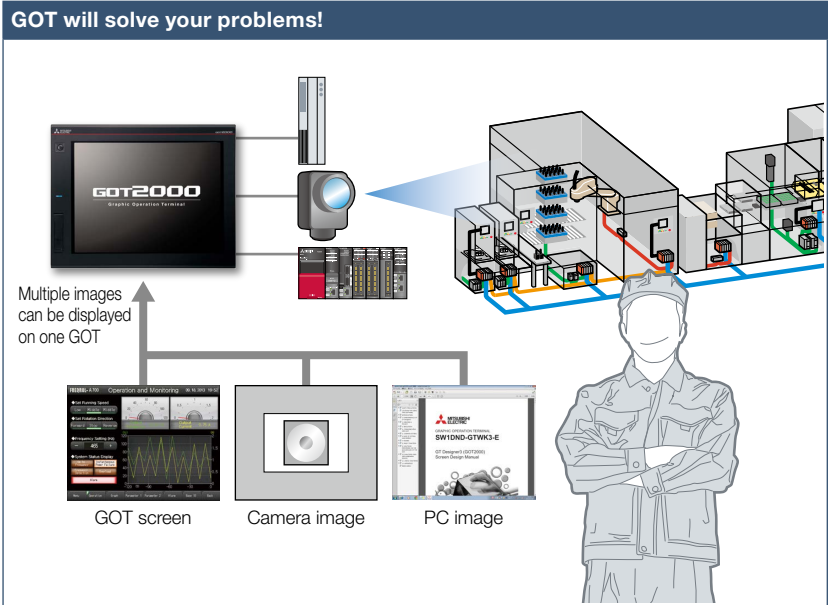

GOT acts as a monitor to display images which are recorded by a video camera or saved in a personal computer, and thus there is no need to have additional monitors.

Function features

GOT acts as a monitor to display images which are recorded by a video camera or saved in a personal computer.

Video input*1

Input images of up to 4 video cameras can be simultaneously displayed on the GOT. You can zoom in or zoom out the images and save the GOT images (hard copy images).

RGB input*2

RGB images can be displayed on the GOT. Simultaneous display of two screens is also possible*3. You can use various effects for the images such as rotation, and gesture operations can be used for zooming in/out (400%) and scrolling objects*3.

RGB output*4

The GOT screen can be displayed on a commercially available large display even when the backlight of the GOT is off.

HDMI output*5

Connect an HDMI compatible monitor and display GOT screens on the large monitor. Since the GOT screen can be displayed on a large monitor, it is recommended for ANDON applications.

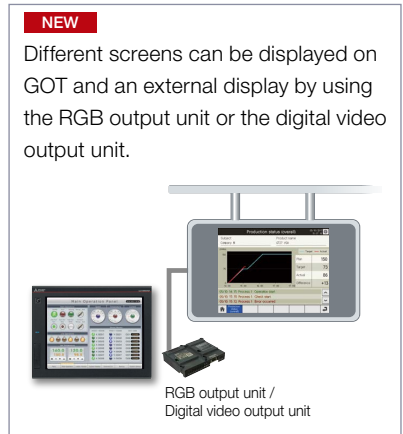

*1 Video input unit (GT27-V4-Z) or video/RGB input unit (GT27-V4R1-Z) is required.
 *2 RGB input unit (GT27-R2) or video/RGB input unit (GT27-V4R1-Z) is required.
 *3 Supported by GT27-R2 only.
 *4 RGB output unit (GT27-ROUT) is required.
 *5 Digital video output unit (GT27-VHOUT) is required.

Specification details and restrictions

* For the necessary option devices, please refer to the "Function list" (page 166).

- **Unit installation** One of the following units can be installed: multimedia unit, video input unit, digital video output unit, RGB input unit, video/RGB input unit, RGB output unit
- **Applicable peripheral devices** For the details, please refer to the Technical Bulletin No. GOT-A-0064 on the Mitsubishi Electric Factory Automation Global website (www.MitsubishiElectric.com/fa/).

Recommended industries

Automotive	SEMICON, LCD	Electronics
F & B	Pharma	Plant

Supported GOT types

GT27*	GT25	GT23
GT21	GS21	SoftGOT

Supported devices

PLC	Servo	Inverter
	Robot	CNC

* Excluding GT2705.

Monitor shop floor using video images

NEW

Camera link application



Support maintenance work



Support system operation



Support system design

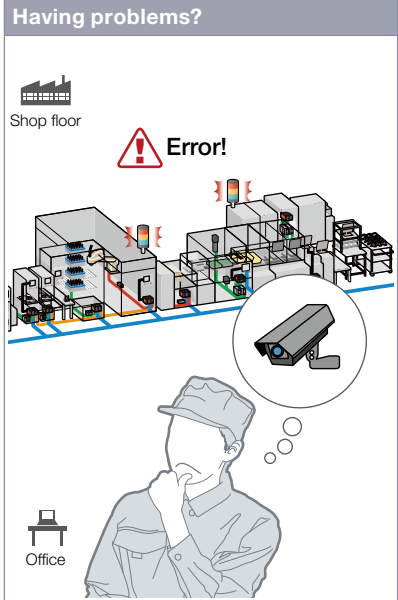

The line has stopped. How can I check the camera image before and after the error occurrence?

Function features

Images from network cameras can be recorded before and after an alarm occurrence by using the alarm of an on-site equipment as a trigger. If multiple alarms occurred simultaneously, camera images of multiple alarms can be recorded all at once. Since the destination to record camera images can be set to a network storage such as a personal computer or NAS, the recorded files can be viewed at a time.



For the details, please refer to the GOT2000 NEWS Vol.12 (L(NA)08739ENG).

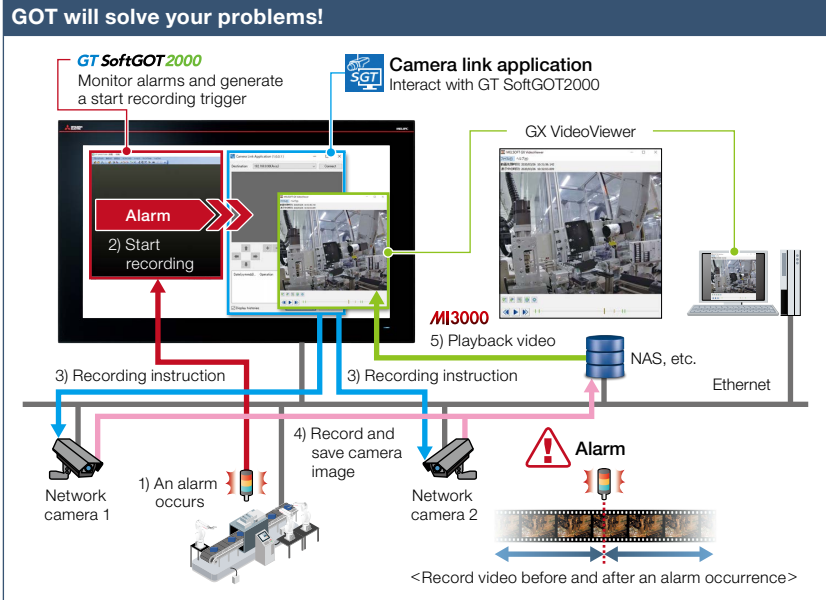

By using the camera link application and GX VideoViewer, the shop floor can be checked with video.

System configuration example

Camera link application*1 specifications	
	1 GT SoftGOT2000
	2 MI3000 or general-purpose PC
	3 Windows® 10, Windows® 10 IoT Enterprise
	4 Network camera manufactured by AXIS®*2
	5 GX VideoViewer*1

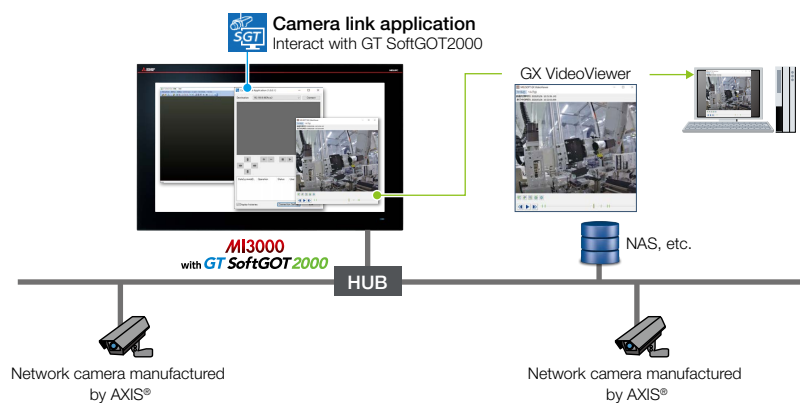

*1 For the details of camera link application and GX VideoViewer, please contact your local sales office.
*2 Usable network cameras are the same as those for the camera recording package. For the details, please refer to the Technical Bulletin "Network cameras supporting the Camera recording package" (FA-A-0306).

Specification details and restrictions

● Supported connection types Ethernet

Recommended industries

Automotive	SEMICON, LCD	Electronics
F & B	Pharma	Plant

Supported GOT types

GT27	GT25	GT23
GT21	GS21	SoftGOT

Supported devices

PLC	Servo	Inverter
	Robot	CNC

GOT Drive Control (Servo) Interactive Solutions

4

GOT Solutions - GOT Drive Control (Servo) Interactive Solutions



MITSUBISHI GRAPHIC OPERATION TERMINAL

GOT2000



MITSUBISHI ELECTRIC SERVO SYSTEM

MELSERVO-J5

MITSUBISHI SERVO AMPLIFIERS & MOTORS

MELSERVO-J4



GOT Drive

The GOT2000 provides advanced functionality and improves connectivity with Mitsubishi servo systems. It provides some functions of MR Configurator2 (supporting MR-J5 and MR-J4).

The GOT Drive enhanced functionality is designed to eliminate need for additional hardware, software and suits customers' applications to speed up system startup, improve maintenance and troubleshooting.



For the details, please refer to the GOT2000 Drive Control (Servo) Interactive Solutions catalog (L(NA)08335ENG).

GOT2000 Series Drive Control Interactive Solutions Movie



GOT and servo system configurations

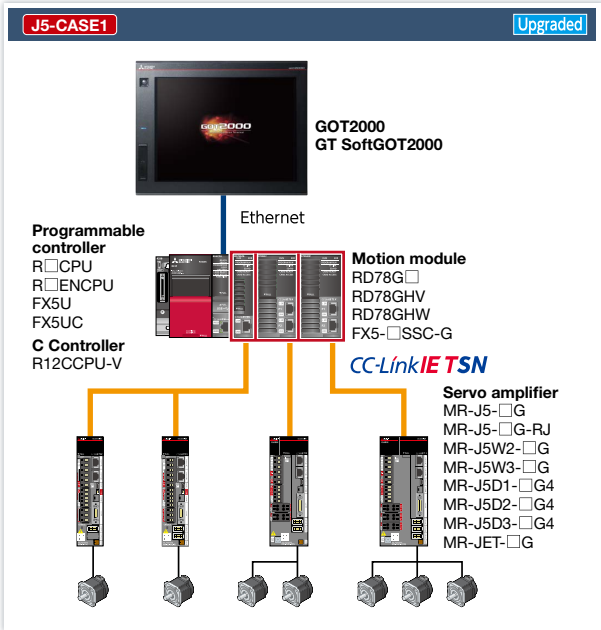

System configuration features

- Command interface: CC-Link IE TSN
- Control mode: positioning control, direct control
- Program
 - Programmable controller CPU: ladder, FBD/LD, ST language
 - Motion module: ST language
- Max. number of control axes
 - RG78G: 4/8/16/32/64 axes
 - RG78GH*1: 128/256 axes
 - FX5-□SSC-G: 4/8 axes

*1 When MR-JET-G servo amplifiers are used for all axes, the maximum number of the control axes is 120.

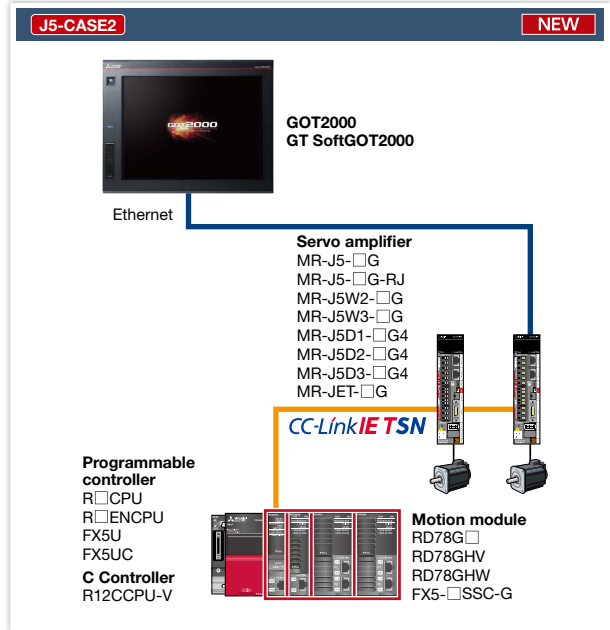

System configuration features

- Command interface: CC-Link IE TSN
- Control mode: positioning control, direct control
- Program
 - Programmable controller CPU: ladder, FBD/LD, ST language
 - Motion module: ST language
- Max. number of control axes
 - RG78G: 4/8/16/32/64 axes
 - RG78GH*1: 128/256 axes
 - FX5-□SSC-G: 4/8 axes

*1 When MR-JET-G servo amplifiers are used for all axes, the maximum number of the control axes is 120.

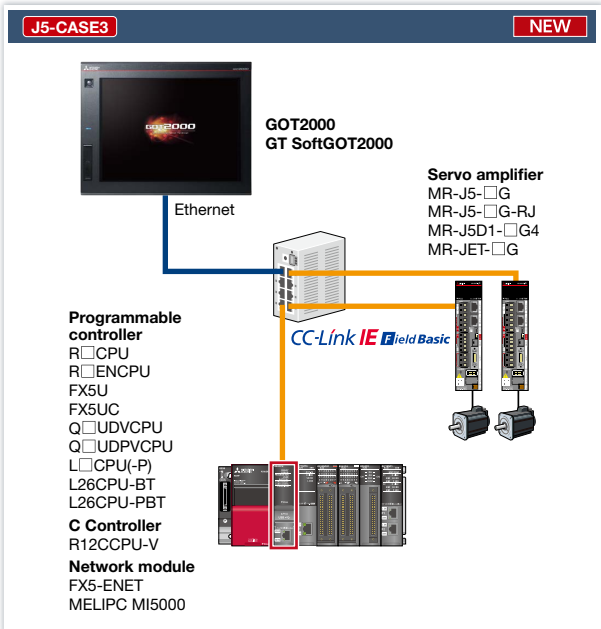

System configuration features

- Command interface: CC-Link IE Field Network Basic
- Control mode: positioning control, direct control
- Program
 - Programmable controller CPU: ladder, FBD/LD, ST language
- Max. number of control axes: 16/32/64 axes

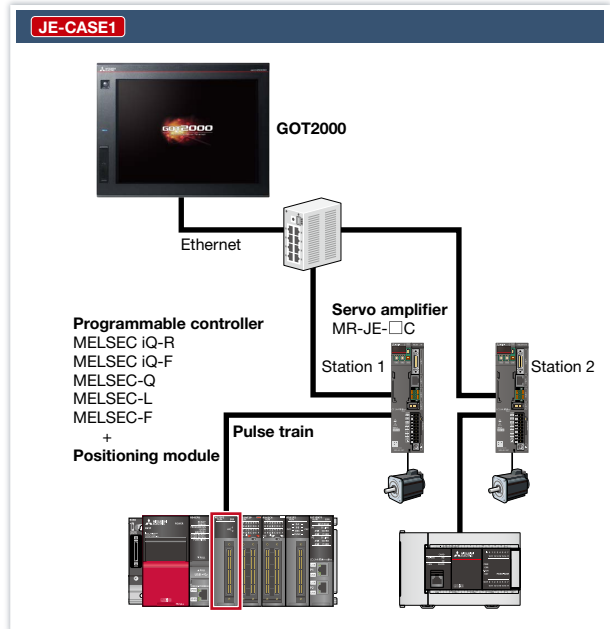

System configuration features

- Command interface: pulse train
- Control mode: positioning control, speed control, torque control
- Program: sequence program (ladder)
- Max. number of control axes: 1/2/4/8 axes

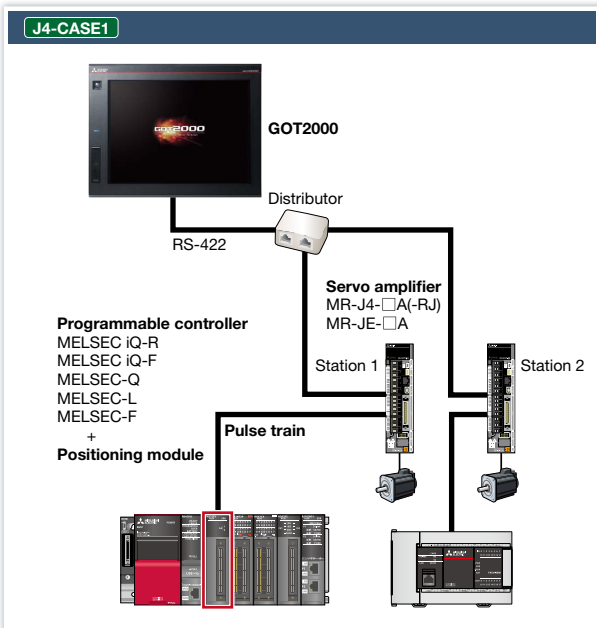

■ System configuration features

- Command interface: pulse train
- Control mode: positioning control
- Program: sequence program (ladder)
- Max. number of control axes: 1/2/4/8/32 axes

* Cannot be used in the MR-J3 compatible mode.

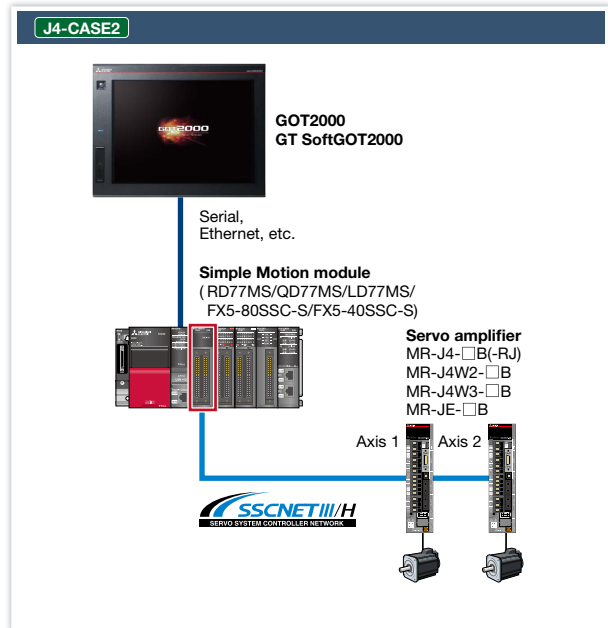

■ System configuration features

- Command interface: SSCNET III/H
- Control mode: positioning control, synchronous control, speed control, torque control, tightening & press-fit control, cam control
- Program: sequence program (ladder)
- Max. number of control axes: 2/4/8/16 axes

* Cannot be used in the MR-J3 compatible mode.

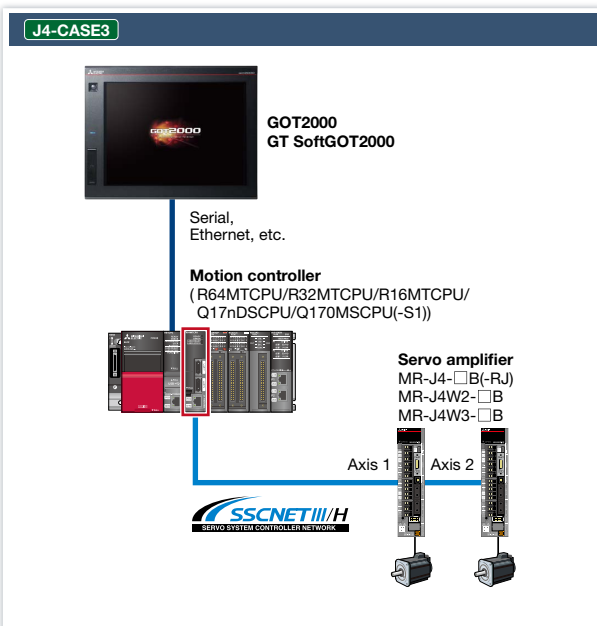

■ System configuration features

- Command interface: SSCNET III/H
- Control mode: positioning control, synchronous control, speed control, torque control, tightening & press-fit control, cam control
- Program: motion program (SFC)
- Max. number of control axes: 16/32/64 axes

* Cannot be used in the MR-J3 compatible mode.

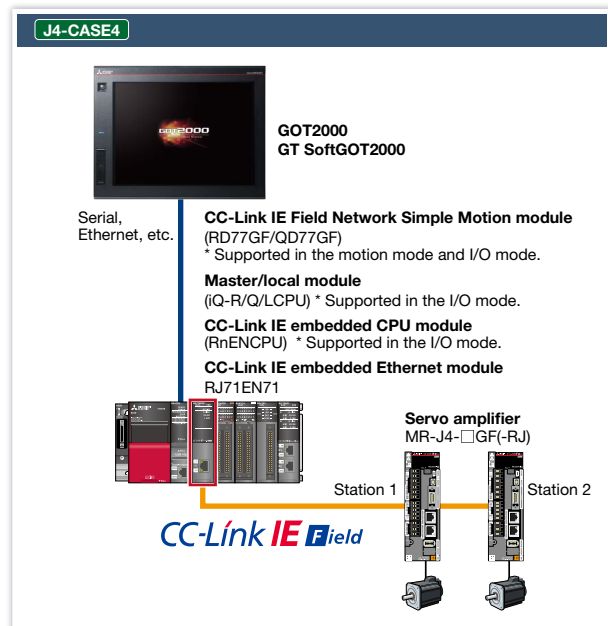

■ System configuration features

- Command interface: CC-Link IE Field Network
- Control mode: positioning control, synchronous control, speed control, torque control, cam control
- Program: sequence program (ladder)
- Max. number of control axes: 4/8/16/32 axes

■ Drive control interactive functions and supported models

Supported drive control interactive functions differ depending on the system configuration.
For the details, please refer to the GOT2000 Drive Control (Servo) Interactive Solutions catalog (L(NA)08335ENG).

Check the servo amplifier data on GOT when an alarm occurs



Support maintenance work

Upgraded

Drive recorder function



In case of a system failure, is there a simple and quick way to check the problem cause?

GOT will solve your problems!

Drive recorder information list screen

Graph waveform screen

Check graph waveform from the alarm list!

Servo data such as motor current and position command before and after the alarm occurrence can be read from the servo amplifier and displayed in a waveform or a list form.

Function features

GOT can be used to display the screen equivalent to the drive recorder of MR Configurator2. Easily check the servo data (motor current, position command, etc.) on GOT without using a personal computer. The servo data can be stored on the GOT's SD memory card or USB memory. After obtaining the servo data, you can send it to an office in a remote location and quickly solve the problem.

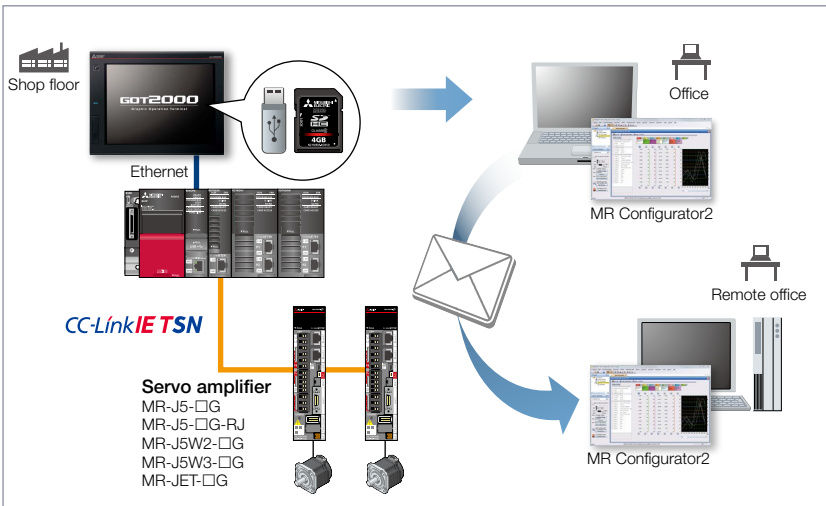

Specification details and restrictions

* For the necessary option devices, please refer to the "Function list" (page 166).

- **Target models** MELSERVO-J5 Series (MR-J5-□G(-RJ), MR-J5W2-□G, MR-J5W3-□G), MELSERVO-J4 Series (MR-J4-□B(-RJ), MR-J4W2-□B, MR-J4W3-□B, MR-J4-□GF(-RJ)), MELSERVO-JE Series (MR-JE-□B), MELSERVO-JET Series (MR-JET-□G)
- **Supported connection types***1 Connection via Motion controller/Simple Motion module, connection via Motion module
- *1 For the details of connectable models of each connection type, please refer to the "Connectable model list" (page 170).
- **How to obtain sample screens** The switch to start the drive recorder function has been added to the sample screen. Sample screens are included in GT Works3. For the details, please contact your local sales office. The sample screens are supported by the following GT Works3 versions.
 MR-J4-□B(-RJ), MR-J4W2-□B, MR-J4W3-□B: Ver.1.155M or later.

Recommended industries

- Automotive
- Electronics
- F & B
- Pharma

Supported GOT types

- GT27
- GT25
- GT23
- GT21
- GS21
- SoftGOT*

Supported devices

- PLC
- Servo
- Inverter
- Robot
- CNC

* Supported by GT SoftGOT2000 (Multiple channels) only.

Support startup and maintenance of servo systems



Support maintenance work

Upgraded

Servo amplifier graph function

Having problems?

If waveform data can be checked and adjusted on GOT, you do not need to bring a PC.



GOT will solve your problems!



Servo amplifier graph waveform

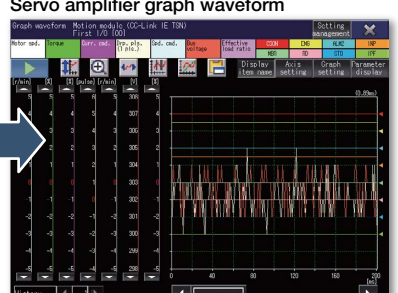

The data of each axis (speed, torque values, etc.) are shown in up to 64 lines in a graph using a window screen on a user-created screen.

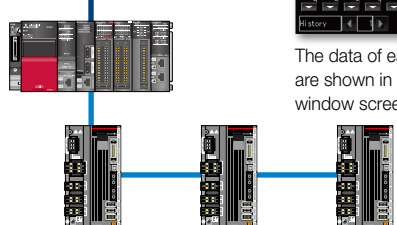

Can I adjust gains while checking the waveform data at the shop floor?

The servo amplifier graph function visualizes changes in operation of the equipment due to gain adjustment. Without using a personal computer, you can adjust gains and check parameter information efficiently.

Function features

Since gain adjustment and parameters check can be performed without using a personal computer, servo systems can be started up efficiently. Superimposing normal and abnormal waveform data and analyzing them helps in equipment maintenance.

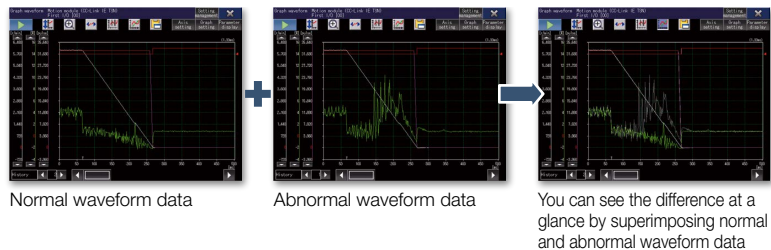

Analyze the waveform data of a servo amplifier

In the servo amplifier graph function, a specific period of time can be set in the collection and trigger setting window. Then the waveform data that occurred within the set period and the parameter information can be buffered in a servo amplifier, and can be read out and displayed on the GOT. By saving a normal waveform data as a history, you can compare it with the data measured in the same conditions by superimposing them; therefore it is useful for equipment maintenance.

Specification details and restrictions

* For the necessary option devices, please refer to the "Function list" (page 166).

● **Target models** MELSERVO-J5 Series (MR-J5-□G(-RJ), MR-J5W2-□G, MR-J5W3-□G), MELSERVO-J4 Series (MR-J4-□B(-RJ), MR-J4W2-□B, MR-J4W3-□B), MELSERVO-JE Series (MR-JE-□B), MELSERVO-JET Series (MR-JET-□G)

● **Supported connection types*** Connection via Motion CPU/Simple Motion module*²⁺³, connection via Motion module

*1 For the details of connectable models of each connection type, please refer to the "Connectable model list" (page 170).

*2 When a programmable controller is connected to a servo amplifier through a Simple Motion module (SSCNET III/H), GOT and a Motion CPU (Q Series) or GOT and CR800-Q (Q172DSRCPU) cannot be directly connected via Ethernet.

*3 When a servo amplifier is connected to the GOT through a Motion CPU (Q Series), use a connection type other than the CC-Link IE Field Network connection between the CPU and the GOT. When the Motion CPU and the GOT are connected by CC-Link connection (intelligent device station), set [MELSEC (compatible)] to the transmission path.

Recommended industries

Automotive	SEMICON, LCD	Electronics
F & B	Pharma	Plant

Supported GOT types

GT27	GT25	GT23
GT21	GS21	SoftGOT*

Supported devices

PLC	Servo	Inverter
	Robot	CNC

* Supported by GT SoftGOT2000 (Multiple channels) only.

Support servo system maintenance



Upgraded

Machine diagnosis function

4

GOT Solutions - GOT Drive Control (Servo) Interactive Solutions

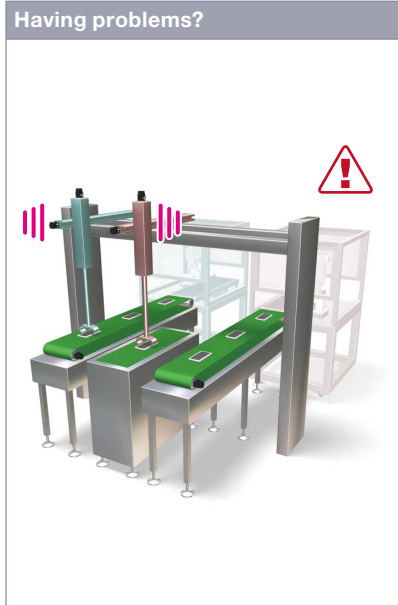

GOT will solve your problems!

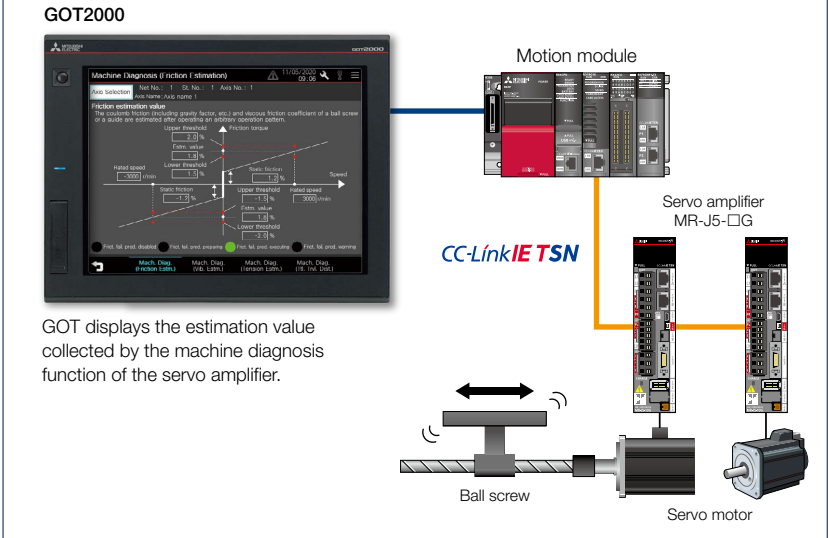

How can I predict deterioration of a machine if it has excessive load and is frequently accelerated?

Without using a personal computer, you can predict the deterioration of the machine for easy preventive maintenance.

Function features

GOT displays the machine diagnosis screen that is equivalent to the maintenance functions of MR Configurator2. You can easily check the machine diagnosis information of servo amplifiers on the GOT without a personal computer.

Failure prediction function

When connecting to MR-J5 or MR-J4-GF(-RJ), the servo amplifier detects and notifies deterioration of drive components. By grasping the failure prediction information of the production line and performing maintenance at appropriate time, operation rate of the whole production line can be increased.

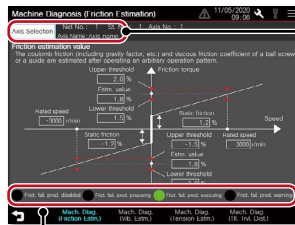

Displays the status of friction failure prediction.

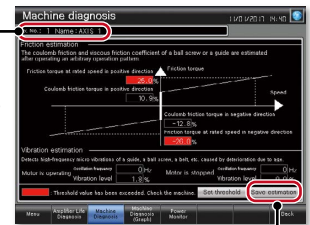

Save estimation values to a file and compare the values to check the deterioration of the machine.

Machine diagnosis screen (friction estimation) (MR-J5)*1

GOT displays machine diagnosis information (friction estimation) and friction failure prediction diagnosed by the servo amplifier.

Machine diagnosis screen (MR-J4)*1

GOT displays estimation values (machine friction, torque vibration, etc.) that are collected by the machine diagnosis function of the servo amplifier. When any of the estimation values exceed the threshold values that are set on the GOT, the numerical value display area turns red.

*1 Ready to use sample screens (VGA) are available.

Specification details and restrictions

- **Target models** MELSERVO-J5 Series (MR-J5-□G(-RJ), MR-J5W2-□G, MR-J5W3-□G, MR-J5D1-□G4, MR-J5D2-□G4, MR-J5D3-□G4), MELSERVO-J4 Series (MR-J4-□A(-RJ), MR-J4-□B(-RJ), MR-J4W2-□B, MR-J4W3-□B, MR-J4-□GF(-RJ)), MELSERVO-JE Series (MR-JE-□A, MR-JE-□B)
- **Supported connection types*1** Direct connection with a servo amplifier (RS-422, Ethernet), connection via Motion controller/Simple Motion module, connection via CC-Link IE Field Network Simple Motion module/master or local station module, connection via Motion module
- *1 For the details of connectable models of each connection type, please refer to the "Connectable model list" (page 170).
- **Machine diagnosis** In order to estimate the friction by using the machine diagnosis function, the machine must be operated at high speed as well as at low speed for at least 150 seconds each. For the details, please refer to the manual of the servo amplifier being used or the help of MR Configurator2.
- **How to obtain sample screens** Sample screens are included in GT Works3. For the details, please contact your local sales office. The sample screens are supported by the following GT Works3 versions. MR-J5-□G: Ver.1.245F or later, MR-J4-□A(-RJ): Ver.1.126G or later, MR-J4-□B(-RJ), MR-J4W2-□B, MR-J4W3-□B: Ver.1.155M or later, MR-JE-□B: Ver.1.150G or later.

Recommended industries

- Automotive
- Electronics
- F & B
- Pharma

Supported GOT types

- GT27
- GT25
- GT23
- GT21
- GS21
- SoftGOT*

Supported devices

- PLC
- Servo
- Inverter
- Robot
- CNC

* Excluding some devices and connection types. For the details, please refer to the "Connectable model list" (page 187).

NEW

MR-J5 sample screens

Sample screens for MELSERVO-J5 are available on GOT to make it easy to display parameters and to set various diagnosis modes, which are necessary for startup, adjustment, and maintenance work. In addition to the screens described below, test operation, operation monitoring, and others are also supported.

[Application] Predicting ball screw and linear guide failure

Machine Diagnosis (Friction Estimation)

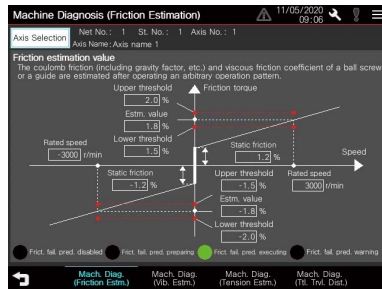

Machine Diagnosis (Vibration Estimation)

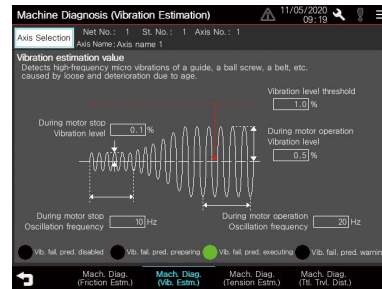

[Application] Predicting belt failure

Machine Diagnosis (Tension Estimation) (1)

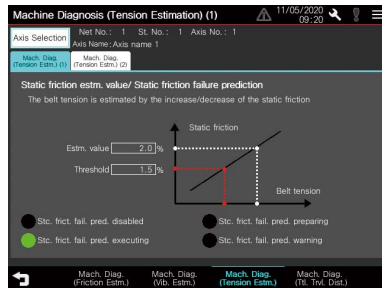

Machine Diagnosis (Tension Estimation) (2)

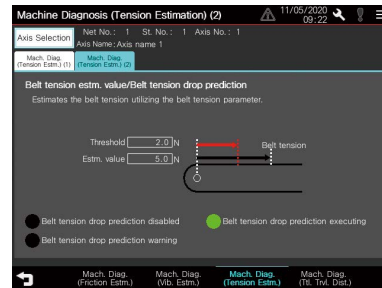

[Application] Monitoring gear wear

Gear Failure Diagnosis

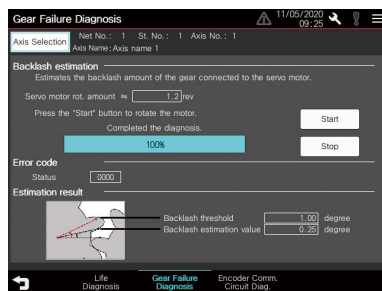

[Application] Identifying whether the failure is caused by an encoder or a servo amplifier

Encoder Communication Circuit Diagnosis

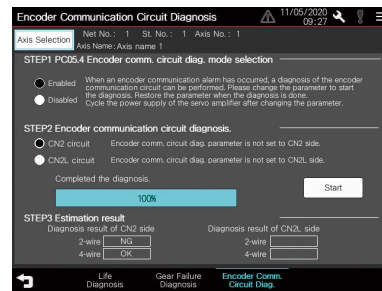

Specification details and restrictions

- **Target models** MELSERVO-J5 Series (MR-J5-□G-(RJ), MR-J5W2-□G, MR-J5W3-□G)
 - **Supported connection types**1** Connection via Motion module
 - *1 For the details of connectable models of each connection type, please refer to the "Connectable model list" (page 170).
 - **How to obtain sample screens** Sample screens are included in GT Works3. For the details, please contact your local sales office.
- The sample screens are supported by the following GT Works3 versions.
MR-J5-□G: Ver.1.245F or later.

Recommended industries

- Automotive
- Electronics
- F & B
- Pharma

Supported GOT types

- GT27
- GT25
- GT23
- GT21
- GS21
- SoftGOT*

Supported devices

- PLC
- Servo
- Inverter
- Robot
- CNC

* Supported by GT SoftGOT2000 (Multiple channels) only.

Support servo system maintenance



Upgraded

■ Servo amplifier life diagnosis function

4

GOT Solutions - GOT Drive Control (Servo) Interactive Solutions

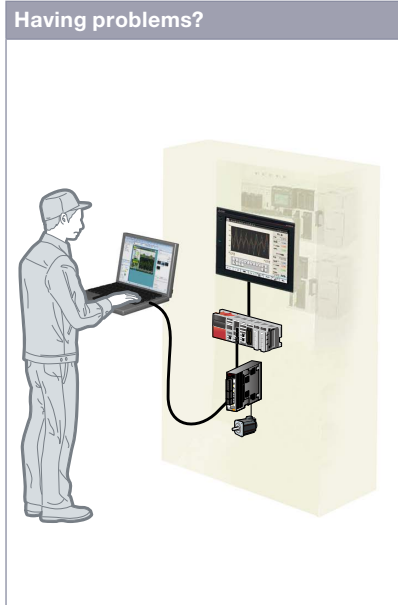

Having problems?
A problem occurred at the shop floor. Can I check the situation in my office?

GOT will solve your problems!

Periodic check

Check the smoothing capacitor energization time or the inrush relay on/off times at a glance

Without creating screens for remote monitoring, check the shop floor on GT SoftGOT2000 by reading project data from GOT at the shop floor.

Function features

GOT displays the amplifier life diagnosis screen that is equivalent to the maintenance functions of MR Configurator2.

You can easily check the internal data of servo amplifiers on the GOT without a personal computer.

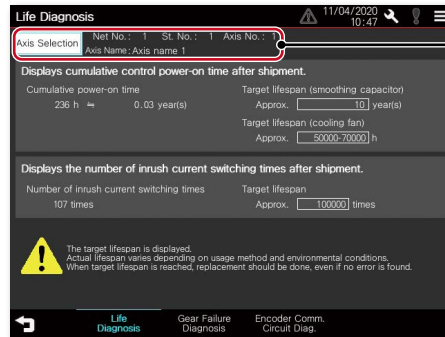

By switching the axis number, multiple axes can be maintained on the same screen.

Life diagnosis screen*1

Check cumulative operation time, on/off counts of inrush relay on GOT. In addition, replacement timing of servo amplifier components (capacitor, relay) can be displayed on the GOT.

*1 Ready to use sample screens (VGA) are available.

Specification details and restrictions

- **Target models** MELSERVO-J5 Series (MR-J5-□G(-RJ), MR-J5W2-□G, MR-J5W3-□G, MR-J5D1-□G4, MR-J5D2-□G4, MR-J5D3-□G4), MELSERVO-J4 Series (MR-J4-□A(-RJ), MR-J4-□B(-RJ), MR-J4W2-□B, MR-J4W3-□B, MR-J4-□GF(-RJ)), MELSERVO-JE Series (MR-JE-□A, MR-JE-□B)
 - **Supported connection types*1** Direct connection with a servo amplifier (RS-422, Ethernet), connection via Motion controller/Simple Motion module, connection via CC-Link IE Field Network Simple Motion module/master or local station module, connection via Motion module
 - *1 For the details of connectable models of each connection type, please refer to the "Connectable model list" (page 170).
 - **How to obtain sample screens** Sample screens are included in GT Works3. For the details, please contact your local sales office.
- The sample screens are supported by the following GT Works3 versions.
 MR-J5-□G: Ver.1.245F or later, MR-J4-□A(-RJ): Ver.1.126G or later, MR-J4-□B(-RJ), MR-J4W2-□B, MR-J4W3-□B: Ver.1.155M or later, MR-JE-□B: Ver.1.150G or later.

Recommended industries

- Automotive
- Electronics
- F & B
- Pharma

Supported GOT types

- GT27
- GT25
- GT23
- GT21
- GS21
- SoftGOT*

Supported devices

- PLC
- Servo
- Inverter
- Robot
- CNC

* Excluding some devices and connection types. For the details, please refer to the "Connectable model list" (page 170).

Support startup and adjustment of servo systems



Support system
startup/
adjustment

Upgraded

One-touch tuning function/Tuning function



It's difficult to determine an optimum gain when setting up the device. It's bothersome to connect a personal computer every time I adjust a gain.

Function features

GOT displays the tuning screens that are equivalent to the adjustment functions of MR Configurator2.

You can easily adjust gain parameters of servo amplifiers on the GOT without a personal computer.

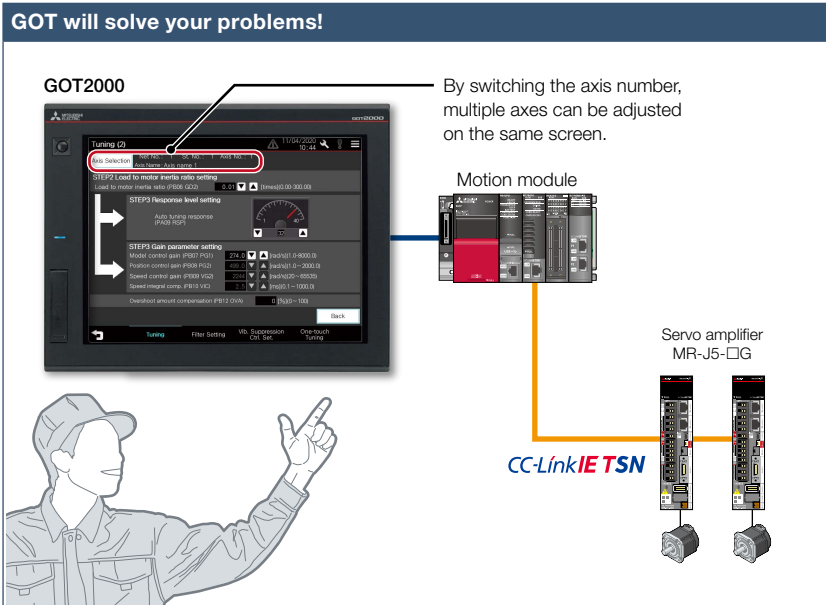

GOT can be used to adjust gains of servo amplifiers. Since the adjustment can be performed in parallel with other setup work, you can efficiently set up the system.

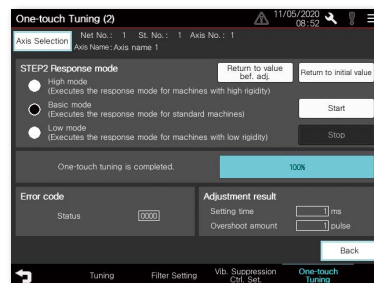

One-touch tuning screen*1

Just a single touch on the switch on the GOT screen. You can check tuning results such as settling time and overshoot amount.



Tuning screen*1

To obtain higher performance, you can perform fine tuning of gain parameters in the tuning screen.

*1 Ready to use sample screens (VGA) are available. The screen images above are the sample screens of MR-J5-□G. The sample screens are different from those for MR-J4-□A and MR-J4-□B.

Specification details and restrictions

● **Target models** MELSERVO-J5 Series (MR-J5-□G(-RJ), MR-J5W2-□G, MR-J5W3-□G, MR-J5D1-□G4, MR-J5D2-□G4, MR-J5D3-□G4), MELSERVO-J4 Series (MR-J4-□A(-RJ), MR-J4-□B(-RJ), MR-J4W2-□B, MR-J4W3-□B, MR-J4-□GF(-RJ)), MELSERVO-JE Series (MR-JE-□A, MR-JE-□B)

● **Supported connection types*1** Direct connection with a servo amplifier (RS-422, Ethernet), connection via Motion controller/Simple Motion module, connection via CC-Link IE Field Network Simple Motion module/master or local station module, connection via Motion module

*1 For the details of connectable models of each connection type, please refer to the "Connectable model list" (page 170).

● **How to obtain sample screens** Sample screens are included in GT Works3. For the details, please contact your local sales office.

The sample screens are supported by the following GT Works3 versions.

MR-J5-□G: Ver.1.245F or later, MR-J4-□A(-RJ): Ver.1.126G or later, MR-J4-□B(-RJ), MR-J4W2-□B, MR-J4W3-□B: Ver.1.155M or later, MR-JE-□B: Ver.1.150G or later.

Recommended industries

- Automotive
- Electronics
- F & B
- Pharma

Supported GOT types

- GT27
- GT25
- GT23
- GT21
- GS21
- SoftGOT*

Supported devices

- PLC
- Servo
- Inverter
- Robot
- CNC

* Excluding some devices and connection types. For the details, please refer to the "Connectable model list" (page 170).

Graphically monitor servo systems



Upgraded

System launcher (servo network) function

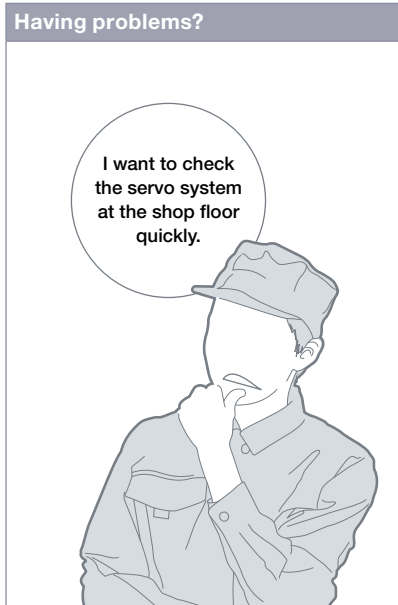

GOT will solve your problems!

System configuration diagram

Select Motion CPU or Simple Motion module

Servo network configuration diagram

Select system launcher (servo network) from the function list

Output the servo system network configuration to a text/CSV file

How can I check the status of servo systems on GOT?

A graphical configuration diagram indicates the status of servo amplifier.

Function features

GOT generates the servo network configuration diagram for the number of used axes so that the servo system can be checked in a graphical screen. By starting the drive recorder from the servo network configuration diagram, you can quickly identify the error cause and solve the problem.

Start various functions from the system launcher (servo network diagram)

Select servo amplifier

Where the error occurred is visible and easy to check

Select a function from the context menu

System configuration display

Displays the model name and the serial number of servo amplifiers or motors.

Alarm display

Displays currently occurring errors in the servo amplifier.

Drive recorder graph waveform

Waveforms can be analyzed from the drive recorder information list screen.

Specification details and restrictions

- **Target models** MELSERVO-J5 Series (MR-J5-□G(-RJ), MR-J5W2-□G, MR-J5W3-□G), MELSERVO-J4 Series (MR-J4-□B(-RJ), MR-J4W2-□B, MR-J4W3-□B), MELSERVO-JET Series (MR-JET-□G)
- **Supported connection types**** Connection via Motion controller/Simple Motion module, connection via Motion module
- *1 For the details of connectable models of each connection type, please refer to the "Connectable model list" (page 170).
- **Extended functions that can be started from the system launcher (servo network)** System launcher, drive recorder, servo amplifier graph

Recommended industries

Automotive	SEMICON, LCD	Electronics
F & B	Pharma	Plant

Supported GOT types

GT27	GT25	GT23
GT21	GS21	SoftGOT*

Supported devices

PLC	Servo	Inverter
	Robot	CNC

* Supported by GT SoftGOT2000 (Multiple channels) only.

Support startup, maintenance, and cost reduction



Support maintenance work

Power monitor

Having problems?

I just need to check power consumption. It's bothersome to connect a personal computer.

GOT will solve your problems!

Calculation data
Servo amplifier MR-J4-□B(-RJ)
Servo motor

Calculate power consumption on servo amplifier

Driving power energy
Servo motor
Regenerative energy

Display power consumption and total power consumption on HMI

To manage specific consumption and observe demand, power consumption should be checked easily.

GOT can be used to check (visualize) power consumption and total power consumption without using measuring equipment such as a power meter or a personal computer.

Specification details and restrictions

- **Target models** MELSERVO-J5 Series (MR-J5-□G(-RJ), MR-J5W2-□G, MR-J5W3-□G, MR-J5D1-□G4, MR-J5D2-□G4, MR-J5D3-□G4), MELSERVO-J4 Series (MR-J4-□A(-RJ), MR-J4-□B(-RJ), MR-J4W2-□B, MR-J4W3-□B, MR-J4-□GF(-RJ)), MELSERVO-JE Series (MR-JE-□A, MR-JE-□B)
 - **Supported connection types***1 Direct connection with a servo amplifier (RS-422, Ethernet), connection via Motion controller/Simple Motion module, connection via CC-Link IE Field Network Simple Motion module/master or local station module, connection via Motion module
 - *1 For the details of connectable models of each connection type, please refer to the "Connectable model list" (page 170).
 - **How to obtain sample screens** Sample screens are included in GT Works3. For the details, please contact your local sales office.
- The sample screens are supported by the following GT Works3 versions.
MR-J4-□A(-RJ): Ver.1.126G or later, MR-J4-□B(-RJ), MR-J4W2-□B, MR-J4W3-□B: Ver.1.155M or later, MR-JE-□B: Ver.1.150G or later.

Recommended industries

Automotive SEMICON, LCD Electronics
F & B Pharma

Supported GOT types

GT27 GT25 GT23
GT21 GS21 SoftGOT*

Supported devices

PLC Servo Inverter
Robot CNC

* Excluding some devices and connection types. For the details, please refer to the "Connectable model list" (page 170).

Upgraded

Alarm display function

Having problems?

What this alarm number indicates?

GOT will solve your problems!

Alarm display

Document display * Not supported by GT23, GT21, and GS21.

Touch here to display the detail information

Check the details of the alarm

How can I easily identify the problem cause when an alarm occurs on a servo amplifier?

Without opening a cabinet, current alarms, alarm history, and the detail information can be checked on GOT. Use the document display function* to display the servo amplifier user's manual and quickly check troubleshooting procedures on the GOT.

* Not supported by GT23, GT21, and GS21.

Specification details and restrictions

- **Target models** MELSERVO-J5 Series (MR-J5-□G(-RJ), MR-J5W2-□G, MR-J5W3-□G, MR-J5D1-□G4, MR-J5D2-□G4, MR-J5D3-□G4), MELSERVO-J4 Series (MR-J4-□A(-RJ), MR-J4-□B(-RJ), MR-J4W2-□B, MR-J4W3-□B, MR-J4-□GF(-RJ)), MELSERVO-JE Series (MR-JE-□A, MR-JE-□B)
 - **Supported connection types***1 Direct connection with a servo amplifier (RS-422, Ethernet), connection via Motion controller/Simple Motion module, connection via CC-Link IE Field Network Simple Motion module/master or local station module, connection via Motion module
 - *1 For the details of connectable models of each connection type, please refer to the "Connectable model list" (page 170).
 - **How to obtain sample screens** Sample screens are included in GT Works3. For the details, please contact your local sales office.
- The sample screens are supported by the following GT Works3 versions.
MR-J5-□G: Ver.1.245F or later, MR-J4-□A(-RJ): Ver.1.126G or later, MR-J4-□B(-RJ), MR-J4W2-□B, MR-J4W3-□B: Ver.1.155M or later, MR-JE-□B: Ver.1.150G or later.

Recommended industries

Automotive SEMICON, LCD Electronics
F & B Pharma

Supported GOT types

GT27 GT25 GT23
GT21 GS21 SoftGOT*

Supported devices

PLC Servo Inverter
Robot CNC

* Excluding some devices and connection types. For the details, please refer to the "Connectable model list" (page 170).

Support startup and adjustment of servo systems



Support system
startup/
adjustment

■ Servo amplifier monitor function

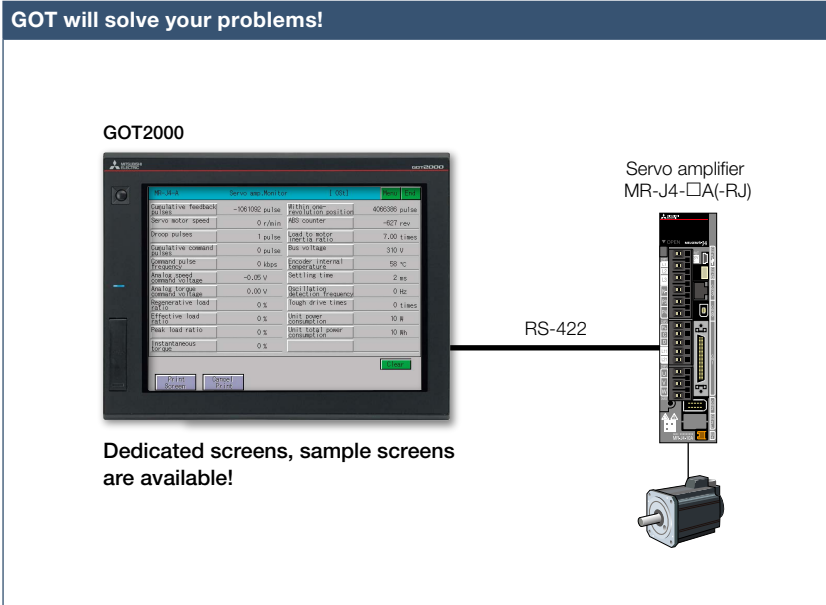

How can I check the status of servo amplifier easily?

In a system which outputs pulse trains, the GOT can be connected to a servo amplifier in a serial connection to perform the following operations: set up, monitoring, alarm display, diagnosis, parameter setting, and test operations.

Function features

Various monitoring functions, changes to the parameter settings, and test operations can be performed on the servo amplifier connected to the GOT.

MR-J4-A Servo amp./Monitor (001)			Print	Close
Cumulative feedback pulses	-1061092 pulse	Within one revolution position	4066398 pulse	
Servo motor speed	0 r/min	ABS counter	-627 rev	
Droop pulses	1 pulse	Load to motor	7.00 times	
Cumulative command pulses	0 pulse	Bus voltage	310 V	
Forward pulse frequency	0 kbps	Encoder internal temperature	58 °C	
Analog speed command voltage	-0.05 V	Settling time	2 ms	
Analog torque command voltage	0.00 V	Oscillation detection frequency	0 Hz	
Regenerative load ratio	0 %	Tough drive times	0 times	
Effective load ratio	0 %	Unit power consumption	10 W	
Peak load ratio	0 %	Unit total power consumption	10 Wh	
Instantaneous torque	0 %			

Dedicated screens*1

Without creating screens, parameters can be monitored and written from dedicated screens.

*1 Not supported by GT21.

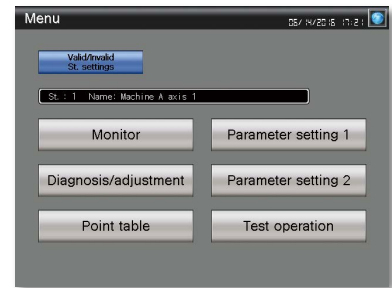

Sample screens (VGA)*2

Various sample screens such as monitoring, parameter settings, test operations are available and they are all customizable.

*2 Sample screens for GT21 are available for GT2104-RTBD.

Specification details and restrictions

- **Target models** MELSERVO-J4 Series (MR-J4-□A(-RJ))

* Supported functions of the servo amplifier monitor vary depending on the servo amplifier model.

- **Supported connection types** Direct connection with a servo amplifier

- **How to obtain sample screens** Sample screens are included in GT Works3. For the details, please contact your local sales office.

The sample screens are supported by the following GT Works3 versions.

MR-J4-□A(-RJ): Ver.1.126G or later.

Recommended industries



Supported GOT types



Supported devices

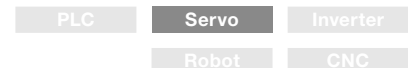

* Restrictions apply to some functions. For the details, refer to the function descriptions above.

Support startup and maintenance of servo systems



Support maintenance work

Intelligent module monitor function

Having problems?

Can I check the programs and the status of a positioning module at the same time?

How can I debug positioning systems efficiently?

GOT will solve your problems!

Intelligent module monitor
RD75D4 monitor screen (example)

GX Works3
ladder monitor screen (example)

USB connection

Operation panel

You can debug positioning systems efficiently by displaying the data such as the status, parameters, and the I/O information of positioning module axes on GOT while monitoring positioning sequence programs on a personal computer simultaneously.

* For the details of supported devices and connection types, please refer to the relevant product manual.

Recommended industries

- Automotive
- SEMICON, LCD
- Electronics
- F & B
- Pharma

Supported GOT types

- GT27
- GT25
- GT23
- GT21
- GS21
- SoftGOT

Supported devices

- PLC
- Servo
- Inverter
- Robot
- CNC

R motion monitor function/Q motion monitor function

Having problems?

Can I check and change servo parameters of a Motion controller easily?

Can I check and change servo parameters of a Motion controller easily?

GOT will solve your problems!

R motion monitor screen

Q motion monitor screen

In a dedicated screen on GOT, it is possible to monitor and set parameters of Motion controllers that are installed on the same base unit.

* For the details of supported devices and connection types, please refer to the relevant product manual.

Recommended industries

- Automotive
- SEMICON, LCD
- Electronics
- F & B
- Pharma

Supported GOT types

- GT27
- GT25
- GT23
- GT21
- GS21
- SoftGOT

Supported devices

- PLC
- Servo
- Inverter
- Robot
- CNC



Support debug of motion SFC programs

■ R motion SFC monitor function **NEW** / Q motion SFC monitor function

Having problems?



Cannot do anything without a PC?

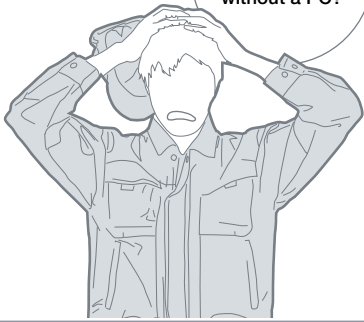

GOT will solve your problems!

Program tabs

Touch a tab to display the program.

Step/transition

The active step is highlighted. Touch the step to display the detail program window. The SFC diagram scrolls automatically along with the progress of active steps.

Detail program window

Displays the program and the present value of the calculation control step/transition.

How can I check motion SFC programs without a personal computer?

GOT can monitor motion SFC programs in the Motion CPU (MELSEC iQ-R Series, MELSEC Q Series) and display them in the SFC diagram format.

Function features

GOT can be used to monitor motion SFC programs and device values of a Motion CPU (MELSEC iQ-R Series, MELSEC Q Series) which is connected to the GOT. Viewing the program batch monitor or active step list enables you to check the complete status at a glance.

No.	Name	State
10	sub1	Stopped
11	sub2_Devtest	Executing
12	sub3	Stopped
13	sub4	Stopped
14	sub5	Stopped
15	sub6	Stopped
16	sub7	Stopped
17	sub8	Stopped
18	sub9	Stopped
19	sub10	Stopped
20	sub11	Stopped

Program batch monitor

No.	Comment
FS103	bit device

Active step list

Specification details and restrictions

* For the necessary option devices, please refer to the "Function list" (page 166).

● **Target models** Motion CPU (MELSEC iQ-R Series*¹, Q Series*²⁺³)

*¹ The R motion SFC monitor function can be used when the following conditions are satisfied.
OS software package: SW10DNC-RMTFW

OS type: standard function OS or G-code controlled add-on library

To use G-code control, the G-code add-on library (paid) must be installed.

*² Use the following production number Motion CPU when using the Q172CPU or Q173CPU.

● Bus connection, direct CPU connection

Q172CPU: production number K***** or later Q173CPU: production number J***** or later

● Other than bus connection, direct CPU connection

Q172CPU: production number N***** or later Q173CPU: production number M***** or later

*³ Operating system software packages for Motion CPU (Q Series) should be SV13 or SV22.

Use a Motion CPU with the following OS installed when using the Q172CPU, Q173CPU, Q172CPUN, or Q173CPUN.

● SW6RN-SV13Q□: 00H or later (00E or later for using the Q172CPU or Q173CPU with the bus connection or direct CPU connection)

● SW6RN-SV22Q□: 00H or later (00E or later for using the Q172CPU or Q173CPU in the bus connection or direct CPU connection)

* Production of Q172CPU, Q173CPU, Q172CPUN, and Q173CPUN has been discontinued.

● **Supported connection types*¹** Ethernet connection*², direct CPU connection, serial communication connection, CC-Link IE Controller Network connection, CC-Link IE Field Network connection, CC-Link IE TSN connection, CC-Link connection, bus connection, MELSECNET connection

*¹ For the details of connectable models of each connection type, please refer to the "Connectable model list" (page 170).

*² When the CC-Link IE Field Network Ethernet adapter module is used, the motion SFC monitor function cannot be used.

Recommended industries

Automotive

Plant

Supported GOT types

GT27

GT25

GT23

GT21

GS21

SoftGOT

Supported devices

PLC

Servo

Inverter

Robot

CNC

Support startup and maintenance of servo systems



Support maintenance work

■ Motion program editor function

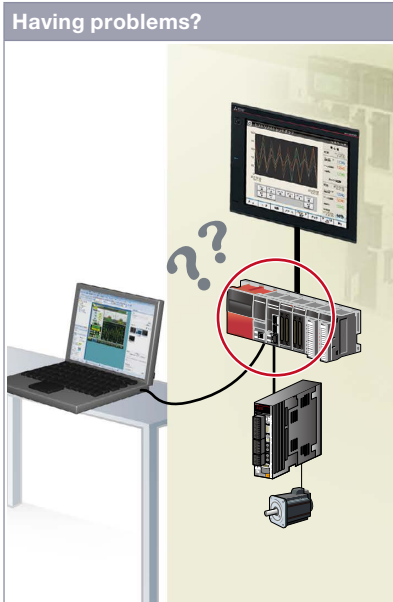

An error occurred during production. Can I edit the motion programs (G-code programs) at the shop floor?

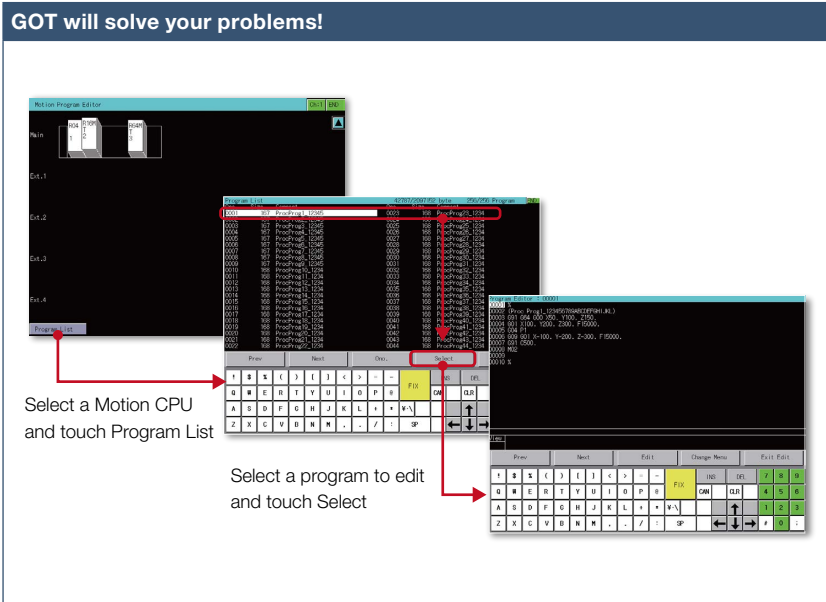

GOT can be used to edit motion programs (G-code programs). You can edit the necessary motion program by selecting it from the program list.

Function features

Motion programs (G-code programs) can be edited in the dedicated screen of the motion program editor function of the GOT.

- * Supported by GOTs with a resolution of SVGA or higher.
- * To use G-code control, the G-code add-on library (paid) must be installed.

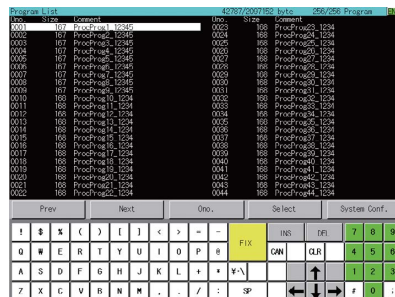

Program List screen

GOT lists the G-code programs stored in the connected Motion CPU (MELSEC iQ-R Series).

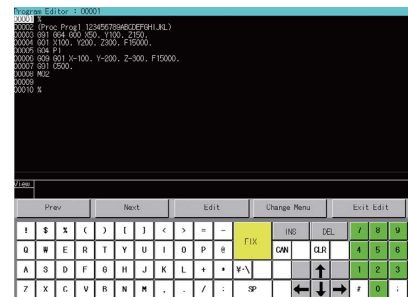

Program Editor screen

G-code programs listed on the GOT can be edited in the line editor format.

Specification details and restrictions

- **Target models*** R64MTCPU/R32MTCPU/R16MTCPU (valid when the G-code add-on library is used)
- *1 When all the following conditions are satisfied, the motion program editor is available.
 - The operating system software is SW10DNC-RMTFW Ver.14 or later.
 - The add-on library is Gcode_Ctrl.adm Ver.0102 or later.
 - Any item other than [Not Used] is set in the G-code control setting in the basic setting.
- **Supported connection types** Ethernet connection

Recommended industries

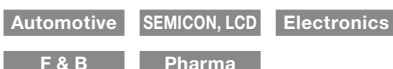

Supported GOT types



* Excluding some models. For the details, refer to the function descriptions above.

Supported devices

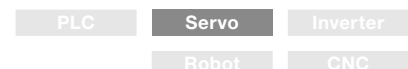

Compilation of interactive functions with servos



Support maintenance work



Support system startup/adjustment



Support system operation

GOT Drive Plus (paid template screens)

Having problems?

In free-version sample screens, only one axis can be checked on a single screen...

The resolution must be changed to fit the GOT.

GOT will solve your problems!

Information of multiple axes

The detailed graph can be displayed from the list screen

Is there an easier way to visualize multi-axes servo systems?

With GOT Drive Plus, data of 16 axes can be displayed on one screen without changing the resolution setting of the GOT project data. By monitoring multiple servo amplifiers in the equipment on one screen, you can comprehensively check the servo system.

Function features

GOT Drive Plus is the paid GOT project data that can visualize servo systems. The data is available for all resolutions of GT27 and GT25 models. Since the template screens for the GOT Mobile function are provided, you can promptly start the remote monitoring of servo systems. The template project can be used as is depending on the system configuration, thus reducing time for screen creation.

Quick remote monitoring with the GOT Mobile function template screens

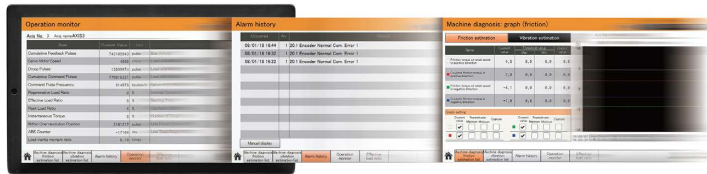

Features comparison

○: Reduced screen design/working man-hours ×: Increased screen design/working man-hours

Item	GOT Drive Plus		GOT Drive
	GT Works3 Add-on License for GOT2000 Enhanced Drive Control (Servo) Project Data (SW1DND-GTSV-MZ)		Sample screens included in GT Works3
Screen design man-hours	○	Screens are designed for every resolution of GT27 and GT25 and can be used to connect to Motion controllers and Simple Motion modules. The screens can be used as it is.	× Sample screens are available only for VGA to connect to Simple Motion modules. The layout must be adjusted according to the resolution of GOT to be used as well as the system configuration.
Multi-axis monitor	○	Up to 16 axes can be monitored at the same time on one screen. [Applicable screens] • Machine diagnosis • Effective load factor • Alarm history * On the screens other than the above, only one axis can be monitored on one screen.	× Only one axis can be monitored on one screen.
Remote monitoring	○	Screens for the GOT Mobile function are provided as standard for remote monitoring on tablets and smartphones.	× Screens for the GOT Mobile function are not available. The users must create the mobile screens.

For the details, please refer to the GOT2000 Drive Control (Servo) Interactive Solutions GOT Drive Plus catalog (L(NA)08594ENG).



Specification details and restrictions

- **Target models** MELSERVO-J4 Series (MR-J4-□B(-RJ), MR-J4-W2-□B, MR-J4W3-□B)
- **Supported connection types***1 Connection via Motion controller/Simple Motion module
- *1 For the details of connectable models of each connection type, please refer to the "Connectable model list" (page 170).
- **Lineup of project data** • WXGA (1280 × 800) • WVGA (800 × 480) • XGA (1024 × 768) • VGA (640 × 480) • SVGA (800 × 600) • 5.7" VGA (640 × 480)

Recommended industries



Supported GOT types



Supported devices



Supported system configurations

Connection via Motion controller

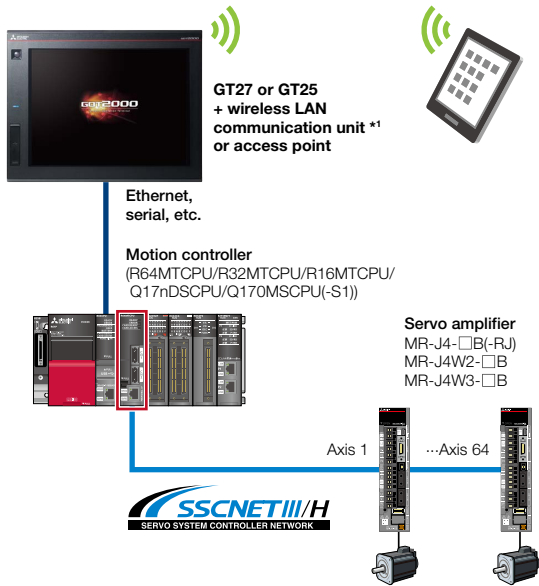

System configuration features

- Command interface: SSCNET III/H
- Max. number of control axes: 64 axes*2

*1 The wireless LAN communication unit cannot be used with GT2505 or GT25 handy model. Use a separate access point.
 *2 Up to 16 selected axes in total among the 64 axes can be monitored.

Connection via Simple Motion module

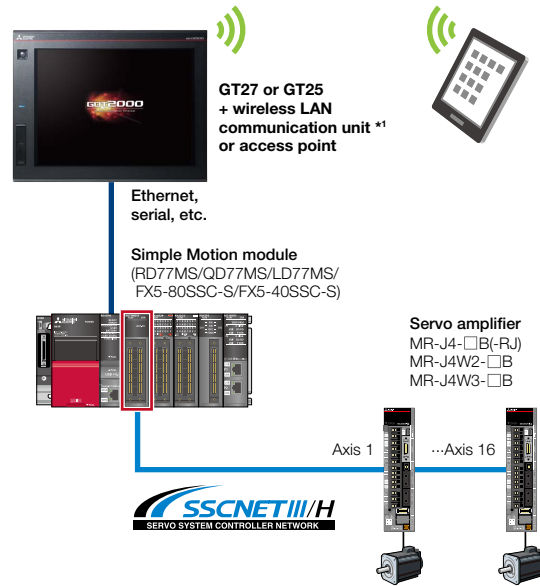

System configuration features

- Command interface: SSCNET III/H
- Max. number of control axes: 16 axes

*1 The wireless LAN communication unit cannot be used with GT2505 or GT25 handy model. Use a separate access point.

Check the entire servo system on one screen

Data of 16 axes can be displayed on one screen. By monitoring multiple servo amplifiers in the equipment on one screen, you can comprehensively check the servo system.

Machine diagnosis

Machine diagnosis: estimation list (friction)

Axis No./Axis name	Friction estimation		Vibration estimation	
	Friction torque at rated speed (%)	Coulomb friction (torque in N)	Friction torque at rated speed (%)	Coulomb friction (torque in N)
1 AX1S1	4.2	1.6	4.0	-1.7
2 AX1S2	6.1	2.0	5.6	-1.4
3 AX1S3	4.6	2.0	-4.4	-2.1
4 AX1S4	4.2	2.2	4.4	-1.3
5 AX1S5	Estimating	Estimating	Estimating	Estimating
6 AX1S6	Estimating	Estimating	Estimating	Estimating

Information of multiple axes

The detailed graph can be displayed from the list screen

Alarm history

Alarm history

Occurred	Axis	Alarm contents
10/03/18 13:17	1	0.1 Undervoltage
10/03/18 13:17	2	1.1 Switch Setting Error
10/03/18 13:17	3	2.1 Memory Error 1 (RAM)
10/03/18 13:17	4	3.1 Clock Error
10/03/18 13:17	5	4.1 Control Process Error
10/03/18 13:17	6	5.1 Memory Error 2 (EEP-ROM)
10/03/18 13:17	7	6.1 Encoder Initial Com. Error 1
10/03/18 13:17	8	7.1 Board Error
10/03/18 13:17	9	8.1 Memory Error 3
10/03/18 13:17	10	A.1 Servo Motor Co

Information of multiple axes

Easy troubleshooting by displaying manuals directly from the alarm history

GOT Drive Control (Inverter) Interactive Solutions



MITSUBISHI GRAPHIC OPERATION TERMINAL GOT2000 + INVERTER

GOT and inverter system configurations

Select the required connection type to match your system configuration. Multiple inverters can be monitored with one GOT by switching the target station number.



For the details, please refer to the GOT2000 Series Drive Control (Inverter) Interactive Solutions catalog (L(NA)08572ENG).

CASE 1 Direct connection with Ethernet

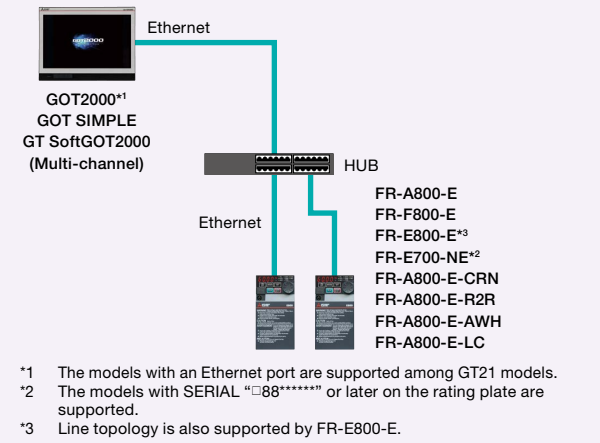

CASE 2 CC-Link IE Field Network connection via programmable controller

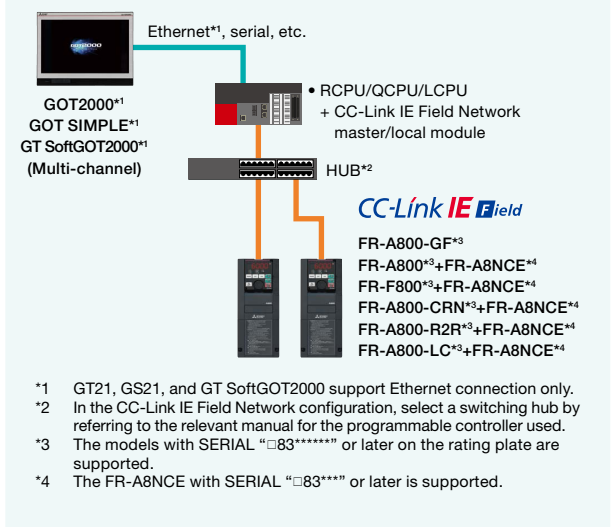

CASE 3 CC-Link IE TSN connection via programmable controller

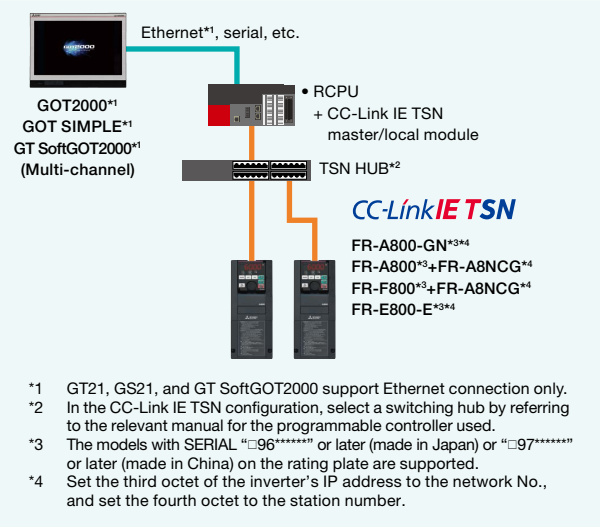

CASE 4 Ethernet connection via programmable controller

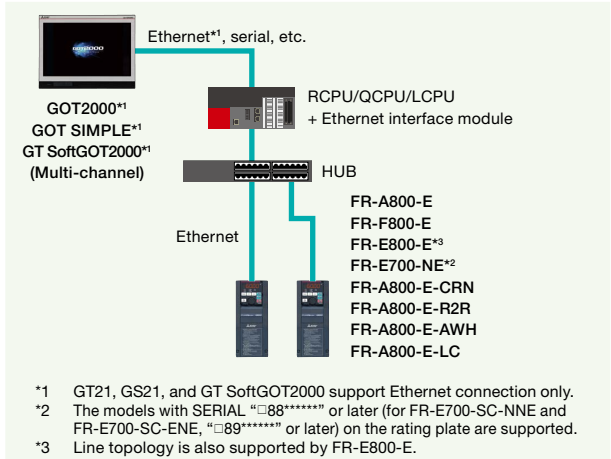

CASE 5 Direct connection with RS-485

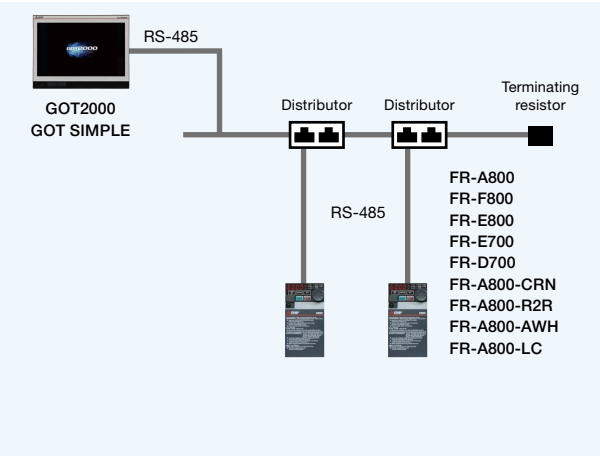

GOT2000 + INVERTER



Drive control interactive functions and supported inverter models (GT Works3 Ver.1.270G)

○: Supported x: Not supported △: Only monitorable parameters are supported —: Not applicable ●: Sample screen available

Function	CASE 1				CASE 2		CASE 3				CASE 4			
	Ethernet connection				CC-Link IE Field Network connection via programmable controller		CC-Link IE TSN connection via programmable controller				Ethernet connection via programmable controller			
	FR-A800-E/ FR-F800-E/ FR-E800-E		FR-E700-NE		FR-A800-GF/ FR-A800+FR-A8NCE/ FR-F800+FR-A8NCE		FR-E800-E		FR-A800-GN/ FR-A800+FR-A8NCG/ FR-F800+FR-A8NCG/		FR-A800-E/ FR-F800-E/ FR-E800-E		FR-E700-NE	
Function available	Sample screen*1*3	Function available	Sample screen*1*3	Function available	Sample screen*1*3	Function available	Sample screen*1*3	Function available	Sample screen*1*3	Function available	Sample screen*1*3	Function available	Sample screen*1*3	
Parameter setting (simple mode)	○	●	○	x	○	●*2	○	●*2	○	x	○	●*2	○	x
Parameter recipe (simple backup/restoration)	○	●	○	x	○	●*2	○	●*2	○	x	○	●*2	○	x
FA transparent*7	○	—	○	—	○*4	—	x	—	x	—	○*4	—	○*4	—
Batch monitor	○	●	○	x	○	●*2	○	●*2	○	x	○	●*2	○	x
Operation command	○	●	○	x	○*5	●*2*5	○*5	●*2*5	○*5	x	○	●*2	○	x
Machine diagnosis (load characteristics measurement)	○	●	x	x	○*5	●*2*5	○*5	●*2*5	○*5	x	○	●*2	x	x
Inverter life diagnosis	○	●	○	x	○	●*2	○	●*2	○	x	○	●*2	○	x
Backup/restoration	x	—	x	—	○	—	x	—	x	—	x	—	x	—
Alarm display	○	●	○	x	○	●*2	○	●*2	○	x	○	●*2	○	x
Document display	○	●	○	x	○	●*2	○	●*2	○	x	○	●*2	○	x

Function	CASE 5						FR-A800 Plus Series							
	RS-485 connection						CASE 1		CASE 2		CASE 4		CASE 5	
	FR-A800/ FR-F800		FR-E800		FR-E700/ FR-D700		Ethernet connection		CC-Link IE Field Network connection via programmable controller		Ethernet connection via programmable controller		RS-485 connection	
Function available	Sample screen*1*3*6	Function available	Sample screen*1*3	Function available	Sample screen*1*3*6	Function available	Sample screen*1*3	Function available	Sample screen*1*3	Function available	Sample screen*1*3	Function available	Sample screen*1*3	
Parameter setting (simple mode)	○	●	○	●*2	○	●	○	x	○	x	○	x	○	x
Parameter recipe (simple backup/restoration)	○	x	○	●*2	○	x	○	x	○	x	○	x	○	x
FA transparent*7	○*4	—	○*4	—	○*4	—	○*8	—	○*4	—	○*4*8	—	○*4*8	—
Batch monitor	○	●	○	●*2	△	●	○	x	○	x	○	x	○	x
Operation command	○	●	○	●*2	○	●	○	x	○*5	x	○	x	○	x
Machine diagnosis (load characteristics measurement)	○	x	○	●*2	x	x	○	x	○*5	x	○	x	○	x
Inverter life diagnosis	○	●	○	●*2	△	●	○	x	○	x	○	x	○	x
Backup/restoration	x	—	x	—	x	—	x	—	x	—	x	—	x	—
Alarm display	○	●	○	●*2	△	●	○	x	○	x	○	x	○	x
Document display	○	●	○	●*2	○	●	○	x	○	x	○	x	○	x

*1 The sample screen is the project data that is included in GT Works3 (Ver.1.235V or later). Sample screens are not supported by GT23, GT21, GS21, and GT SoftGOT2000.
 *2 The sample screen for CASE 1 can be used by changing the controller setting into the one for the system configuration to be used.
 *3 If the sample screen of the required inverter is not available, monitoring is possible by creating a project and setting the inverter parameters and devices in the numerical displays and lamps on the user's screen.
 *4 The function can be used when GOT and personal computer are connected with USB.
 *5 Settings need to be changed so that the CPU devices assigned to RY link devices can be controlled directly from GOT.
 *6 The sample screen monitors one specific inverter. Switching inverters by selecting a station number is not supported.
 *7 Not supported by GT SoftGOT2000.
 *8 The FA transparent function is not supported by FR-A800-E-AWH and FR-A800-AWH.

Support startup and adjustment of inverters



Support system
startup/
adjustment

Parameter settings (simple mode)/Parameter recipe (simple backup/restoration)

4

GOT Solutions - GOT Drive Control (Inverter) Interactive Solutions

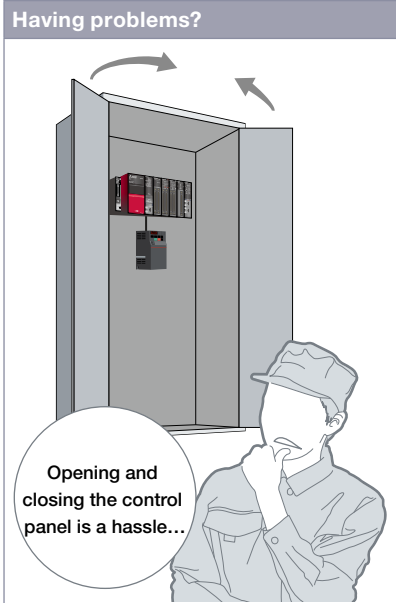

We want to set the parameters without opening the control panel!

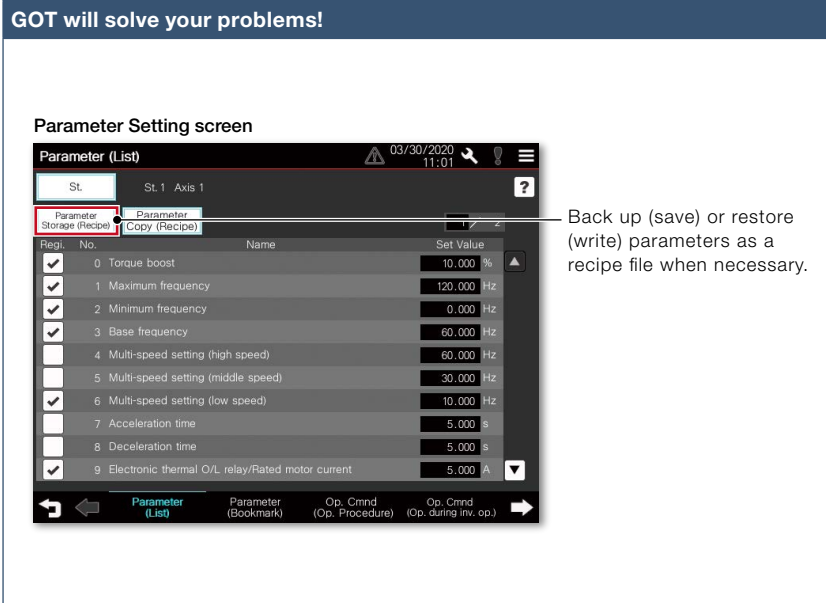

Back up (save) or restore (write) parameters as a recipe file when necessary.

Use GOT to adjust the inverter's simple mode parameters. Since there is no need to open the control panel, the adjustment work efficiency can be increased.

Function features

GOT can be used to adjust parameters of inverters easily. Since the pre-adjustment parameters can be backed up or restored with the GOT, systems can be started up efficiently.

Parameter settings (simple mode)

Use GOT to adjust the inverter's simple mode parameters. The parameter names can be confirmed on a list, so the required parameters can be easily found and adjusted.



Parameter Setting screen

How to return parameters to pre-adjustment values

- Back up the current parameters as a recipe file before adjustment



- Restore parameters that were previously backed up



Parameter recipe (simple backup/restoration)

The current inverter parameters can be backed up (saved) as a recipe file using the GOT. To return the parameters to the pre-adjustment state while starting up and adjusting the inverter, just restore (write) the parameters that were previously backed up (saved).

* Ready to use sample screens (VGA) are available. The screen image differs depending on the model of the inverter.

Specification details and restrictions

● **Target models** FR-A800(-E), FR-A800-GF, FR-A800-GN, FR-E800(-E), FR-F800(-E), FR-E700(-NE), FR-D700, FR-A800(-E)-CRN, FR-A800(-E)-R2R, FR-A800(-E)-AWH, FR-A800(-E)-LC

● **Supported connection types***1 Direct connection with an inverter, connection via a programmable controller, connection via CC-Link IE Field Network master or local station module, connection via CC-Link IE TSN master/local module

*1 For the details of connectable models of each connection type, please refer to the "Connectable model list" (page 170).

● **How to obtain sample screens** Sample screens are included in GT Works3. For the details, please contact your local sales office. The sample screens are supported by the following GT Works3 versions. FR-E800(-E): Ver.1.235V or later, FR-F800(-E): Ver.1.205P or later, FR-A800(-E), FR-A800-GF, FR-E700(-NE), FR-D700: Ver.1.200J or later.

Recommended industries



Supported GOT types



Supported devices



* Supported by GT SoftGOT2000 (Multiple channels) only.

Support startup and adjustment of inverters



Support system
startup/
adjustment

Batch monitor

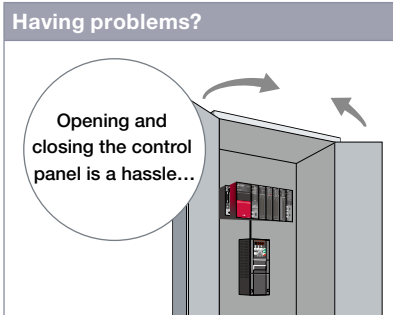

We want to monitor the inverter status without opening the control panel!

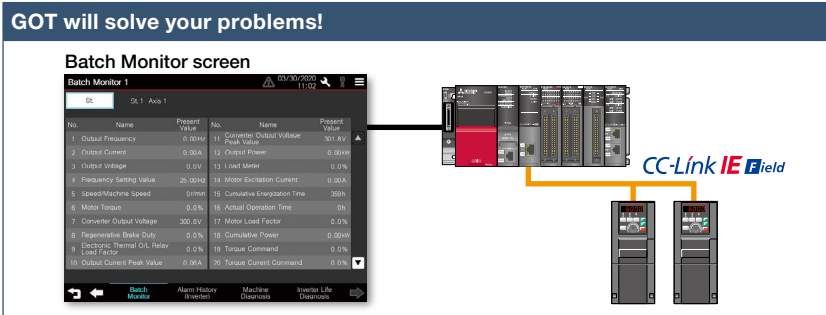

The inverter's current values such as the output frequency, output current, and output voltage can be monitored with the GOT without preparing the personal computer or directly confirming the inverter.

Specification details and restrictions

- **Target models** FR-A800(-E), FR-A800-GF, FR-A800-GN, FR-E800(-E), FR-F800(-E), FR-E700(-NE), FR-D700, FR-A800(-E)-CRN, FR-A800(-E)-R2R, FR-A800(-E)-AWH, FR-A800(-E)-LC
- **Supported connection types*** Direct connection with an inverter, connection via a programmable controller, connection via CC-Link IE Field Network master or local station module, connection via CC-Link IE TSN master/local module
- *1 For the details of connectable models of each connection type, please refer to the "Connectable model list" (page 170).
- **How to obtain sample screens** Sample screens are included in GT Works3. For the details, please contact your local sales office. The sample screens are supported by the following GT Works3 versions. FR-E800(-E): Ver.1.235V or later, FR-F800(-E): Ver.1.205P or later, FR-A800(-E), FR-A800-GF, FR-E700(-NE), FR-D700: Ver.1.200J or later.

Recommended industries



Supported GOT types



Supported devices



* Supported by GT SoftGOT2000 (Multiple channels) only.

Operation command

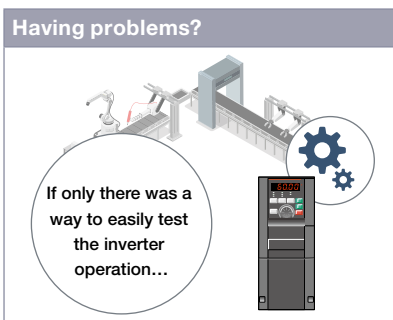

We want to start up the system while confirming the inverter's operation!

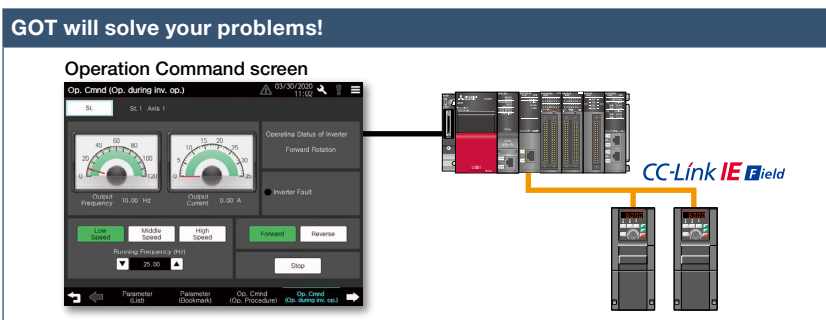

The inverter operation commands can be issued from the GOT. Since the system operation can be confirmed while monitoring the inverter's output frequency and output current values, the startup work efficiency can be increased.

Specification details and restrictions

- **Target models** FR-A800(-E), FR-A800-GF, FR-A800-GN, FR-E800(-E), FR-F800(-E), FR-E700(-NE), FR-D700, FR-A800(-E)-CRN, FR-A800(-E)-R2R, FR-A800(-E)-AWH, FR-A800(-E)-LC
- **Supported connection types*** Direct connection with an inverter, connection via a programmable controller, connection via CC-Link IE Field Network master or local station module, connection via CC-Link IE TSN master/local module
- *1 For the details of connectable models of each connection type, please refer to the "Connectable model list" (page 170).
- **How to obtain sample screens** Sample screens are included in GT Works3. For the details, please contact your local sales office. The sample screens are supported by the following GT Works3 versions. FR-E800(-E): Ver.1.235V or later, FR-F800(-E): Ver.1.205P or later, FR-A800(-E), FR-A800-GF, FR-E700(-NE), FR-D700: Ver.1.200J or later.

Recommended industries



Supported GOT types



Supported devices



* Supported by GT SoftGOT2000 (Multiple channels) only.

Support maintenance of inverters



Machine diagnosis (load characteristics measurement)

4

GOT Solutions - GOT Drive Control (Inverter) Interactive Solutions



We want to detect clogged filters and clogged pipes!

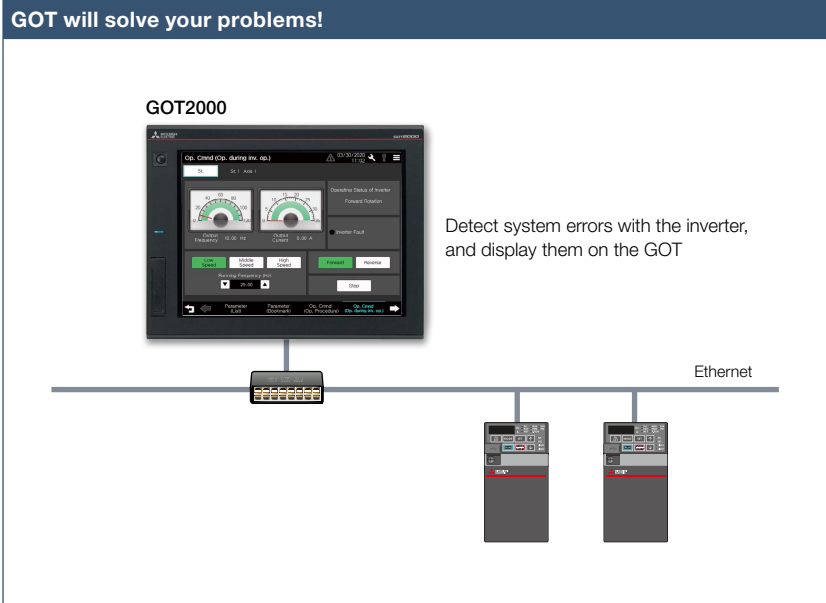

The relation of output frequency and torque in the normal state can be saved in the inverter, and used to check whether the operation is taking place with a normal load. If the result is out of the normal range, an error or warning is output so that it is useful to detect system errors and perform maintenance work.

Function features

Detect system errors with the inverter, and display them on the GOT. If the load is out of the normal range, an error indicator lamp lights up so that it is useful to perform quick troubleshooting.

<Possible error causes>

- In overload range: clogged filter, clogged pipe, etc.
- In light load range: broken belt, broken blade, idle run, etc.

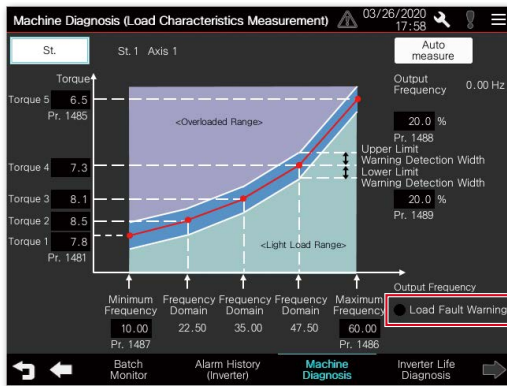

The lamp blinks in yellow when a load fault warning occurs.

Machine Diagnosis (Load Characteristics Measurement) screen

Set the range of frequency to detect load characteristics error and calculate the load characteristics reference value. Set the upper and lower limit warning detection width (threshold value) against the calculated reference value.

Specification details and restrictions

- **Target models** FR-A800(-E), FR-A800-GF, FR-A800-GN, FR-E800(-E), FR-F800(-E), FR-A800(-E)-CRN, FR-A800(-E)-R2R, FR-A800(-E)-AWH, FR-A800(-E)-LC
- **Supported connection types*** Direct connection with an inverter, connection via a programmable controller, connection via CC-Link IE Field Network master or local station module, connection via CC-Link IE TSN master/local module
- *1 For the details of connectable models of each connection type, please refer to the "Connectable model list" (page 170).
- **How to obtain sample screens** Sample screens are included in GT Works3. For the details, please contact your local sales office. The sample screens are supported by the following GT Works3 versions. FR-E800(-E): Ver.1.235V or later, FR-F800(-E): Ver.1.205P or later, FR-A800(-E), FR-A800-GF: Ver.1.200J or later.

Recommended industries

- Automotive
- SEMICON, LCD
- Electronics
- F & B
- Pharma
- Plant

Supported GOT types

- GT27
- GT25
- GT23
- GT21
- GS21
- SoftGOT*

Supported devices

- PLC
- Servo
- Inverter
- Robot
- CNC

* Supported by GT SoftGOT2000 (Multiple channels) only.

Support maintenance of inverters



Support maintenance work

■ Inverter life diagnosis

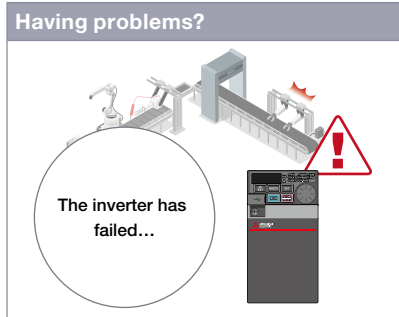

We want to know the inverter replacement timing!

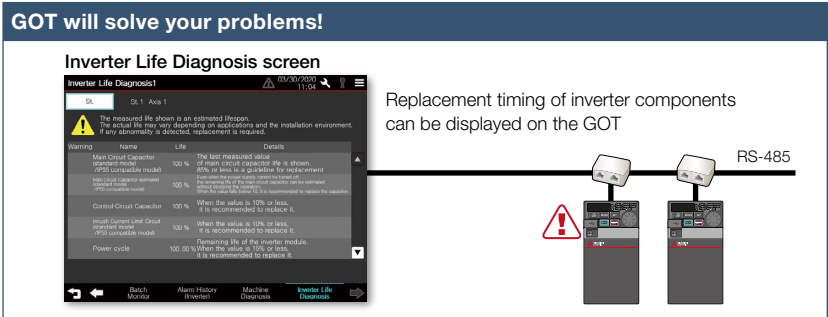

GOT can be used to monitor the operation status of the inverter's components (main circuit capacitor, control circuit capacitor, cooling fan, etc.) and confirm the replacement timing. Perform predictive maintenance by replacing parts before the inverter fails.

Specification details and restrictions

● **Target models** FR-A800(-E), FR-A800-GF, FR-A800-GN, FR-E800(-E), FR-F800(-E), FR-E700(-NE), FR-D700, FR-A800(-E)-CRN, FR-A800(-E)-R2R, FR-A800(-E)-AWH, FR-A800(-E)-LC

● **Supported connection types***1 Direct connection with an inverter, connection via a programmable controller, connection via CC-Link IE Field Network master or local station module, connection via CC-Link IE TSN master/local module

*1 For the details of connectable models of each connection type, please refer to the "Connectable model list" (page 170).

● **How to obtain sample screens** Sample screens are included in GT Works3. For the details, please contact your local sales office. The sample screens are supported by the following GT Works3 versions. FR-E800(-E): Ver.1.235V or later, FR-F800(-E): Ver.1.205P or later, FR-A800(-E), FR-A800-GF, FR-E700(-NE), FR-D700: Ver.1.200J or later.

Recommended industries

Automotive	SEMICON, LCD	Electronics
F & B	Pharma	Plant

Supported GOT types

GT27	GT25	GT23
GT21	GS21	SoftGOT*

* Supported by GT SoftGOT2000 (Multiple channels) only.

Supported devices

PLC	Servo	Inverter
	Robot	CNC

■ FA transparent

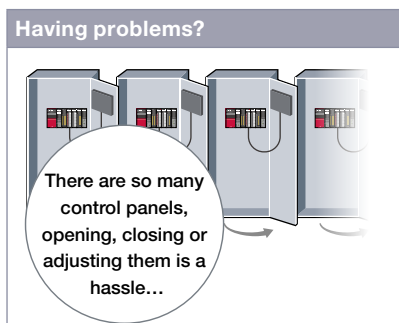

We want to perform debugging smoothly!

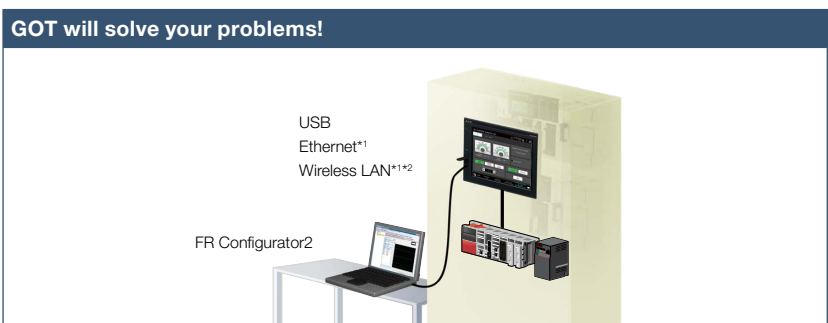

By connecting a personal computer with the GOT's USB interface, the inverter can be programmed, started up, and adjusted via GOT. There is no need to open the control panel and change the cable.

*1 Some system configurations are not supported. For the details, please refer to the connection manual.

*2 Installation of the wireless LAN communication unit (GT25-WLAN) is required on the GOT. The unit cannot be used with GT2505, GT25 handy, GT23, GT21, and GS21 models. For the countries where the wireless LAN communication unit can be used and other details, please refer to the "Product list" (page 198).

Specification details and restrictions

● **Target models** FR-A800(-E), FR-A800-GF, FR-E800(-E), FR-F800(-E), FR-E700(-NE), FR-D700, FR-A800(-E)-CRN, FR-A800(-E)-R2R, FR-A800(-E)-LC

● **Supported connection types***1 Connection via a programmable controller, connection via CC-Link IE Field Network master or local station module

*1 For the details of connectable models of each connection type, please refer to the "Connectable model list" (page 170).

Recommended industries

Automotive	SEMICON, LCD	Electronics
F & B	Pharma	Plant

Supported GOT types

GT27	GT25*	GT23*
GT21*	GS21*	SoftGOT

* Excluding some system configurations or restrictions apply to some functions. For the details, please refer to the connection manual.

Supported devices

PLC	Servo	Inverter
	Robot	CNC

GOT Drive Control (Robot) Interactive Solutions



Support system
startup/
adjustment

Interactive functions to support startup and maintenance of robots

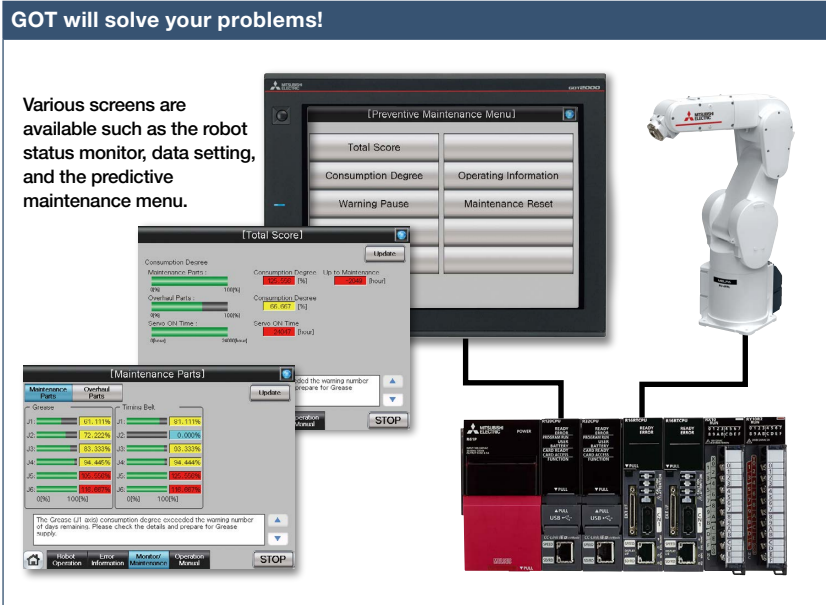

How can I startup and adjust robots easily?

Use GOT to operate or monitor the status of a robot. The robot can be started and stopped, and the error information can be monitored easily from the GOT.

Function features

GOT can be used for simple adjustment of robots. The robot error information can also be checked; therefore, it is useful for troubleshooting.

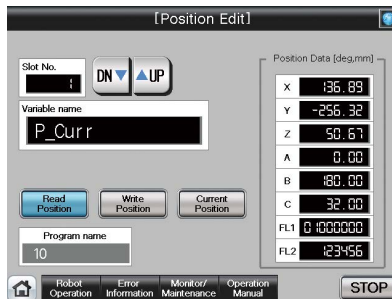

Position edit screen*1

Position variables of robots can be edited.

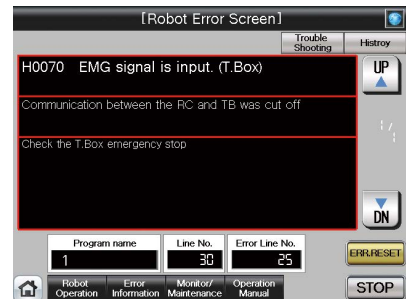

Robot error screen*1

The details of errors on robots can be checked.

*1 Ready to use sample screens (VGA) are available. Sample screens are not supported by GT23, GT21, and GS21.

Specification details and restrictions

● **Target models** FR Series (CR800-R (R16RTCPU), CR800-Q (Q172DSRCPU), CR800-D)*1, F Series (CR750-Q (Q172DRCPU), CR751-Q (Q172DRCPU), CR750-D)*1, CR751-D)*1, SQ Series CRnQ-700 (Q172DRCPU), SD Series CRnD-700

*1 Sample screens are available. Sample screens are not supported by GT23, GT21, and GS21.

● **Supported connection types*1** Ethernet connection, direct CPU connection (serial), serial communication connection, CC-Link IE Controller Network connection, CC-Link IE Field Network connection, CC-Link connection, bus connection, MELSECNET connection

*1 For the details of connectable models of each connection type, please refer to the "Connectable model list" (page 170).

● **How to obtain sample screens** For the details, please contact your local sales office. The sample screens are supported by the following GT Works3 versions. FR Series (CR800-R (R16RTCPU), CR800-Q (Q172DSRCPU), CR800-D): Ver.1.205P or later, F Series (CR750-D, CR751-D): Ver.1.153K or later.

Recommended industries

Electronics F & B

Supported GOT types

GT27 GT25 GT23
GT21 GS21 SoftGOT

Supported devices

PLC Servo Inverter
Robot CNC

Network camera live image display and PTZ adjustment on GOT

NEW

Sample screens for live & PTZ cameras connected via the MELSEC iQ-R camera recorder module



Having problems?

How can I check the image from a network camera without using a PC at the shop floor?

GOT will solve your problems!

P (pan), T (tilt), and Z (zoom) settings can be adjusted on the GOT

GOT can be used to check a live image being captured by the network camera without using a personal computer at the shop floor. P (pan), T (tilt), and Z (zoom) settings can be adjusted on the GOT near the object while checking a live image from the network camera.

Function features

GOT2000 and GT SoftGOT2000 can be used to display the live image from a network camera via the MELSEC iQ-R camera recorder module and adjust the P (pan), T (tilt), and Z (zoom) settings of the network camera.

Sample screens are available for live image streaming and PTZ adjustment of network cameras that are connected via the MELSEC iQ-R camera recorder module.



For the details, please refer to the GOT2000 NEWS Vol.13 (L(NA)08778ENG).

System configuration supported by the sample screens

*1 Be sure to set a value other than 0, 255, or the one that is used for other equipment.
*2 For the supported network cameras, please refer to the Technical Bulletin "Applicable Products for Camera Recorder Module" (FA-A-0326).

Specification details and restrictions

● **How to obtain sample screens** Sample screens are included in GT Works3 Ver.1.250L or later. For the details, please contact your local sales office.

Recommended industries

- Automotive
- SEMICON, LCD
- Electronics
- F & B
- Pharma
- Plant

Supported GOT types

- GT27
- GT25
- GT23
- GT21
- GS21
- SoftGOT

Support debug of SFC programs



Support maintenance work

■ Sequence program monitor (SFC) function

Having problems?

GOT will solve your problems!

Block tabs
Touch a tab to display the block.

Displayed by steps
The active step is highlighted. Touch the step to display the zoom window or SFC diagram of the relevant block. The SFC diagram scrolls automatically along with the progress of active steps.

Transition condition
Touching a transition condition displays a window for turning on or off a bit device.

How can I debug SFC programs without a personal computer?

GOT can monitor SFC programs of the PLC CPU and display the programs in the SFC diagram format (MELSAP3 or MELSAP-L format).

Function features

With the sequence program monitor (SFC), the GOT can monitor SFC programs of controllers, and changing device values of the programs is available. The function can be used to solve problems and maintain programmable controller systems that use SFC programs.

Step List Block No.0

No.	Step	Comment
0	Operation permission wait	
1	Work carrier detection wait	
2	Buzzer output	
3		
4	Product counter reset	
5	Product counter reset	
6	Conveyor operation	

Active Step List Block No.0

No.	Step	Comment
0	Operation permission wait	

Step list

GOT displays steps in the displayed block.

Active step list

GOT displays active steps in the displayed block.

Specification details and restrictions

- **Target models** QCPU (Q mode), LCPU
 - **Supported connection types***1 Ethernet connection*2, direct CPU connection (serial)*3, serial communication connection, CC-Link IE Controller Network connection, CC-Link IE Field Network connection, CC-Link connection, bus connection, MELSECNET connection
- *1 For the details of connectable models of each connection type, please refer to the "Connectable model list" (page 170).
 *2 When the CC-Link IE Field Network Ethernet adapter module is used, the sequence program monitor (SFC) function cannot be used.
 *3 When the Q12PRHCPU or Q25PRHCPU is used, the sequence program monitor (SFC) function cannot be used.

* For the necessary option devices, please refer to the "Function list" (page 166).

Recommended industries

Automotive Plant

Supported GOT types

GT27 GT25 GT23
GT21 GS21 SoftGOT

Supported devices

PLC Servo Inverter
Robot CNC

Support RCP, FX5CPU, QCPU, and LCP maintenance



Sequence program monitor (Ladder, iQ-R ladder, iQ-F ladder **NEW**) function

Having problems?

If only I could add a contact and a coil to debug the program...

GOT will solve your problems!

Ladder monitor screen
Shop floor

Factor search screen

Ladder editor screen

How can I debug and edit ladder programs without a personal computer?

When an error occurs, monitor the ladder program and identify the cause of error. There is no need for a personal computer on the production floor. Just touch the GOT screen and easily edit the ladder program to make simple changes.

Function features

GOT can monitor and edit a sequence program in a controller in the ladder format, and also can change current values of devices.

Sequence program monitor (Ladder monitor)

Sequence programs of RCP, FX5CPU **NEW**, QCPU, and LCP can be monitored in the ladder format.

Ladder editor

Sequence programs of RCP, FX5CPU **NEW**, QCPU, and LCP can be edited in the ladder format. Just touch the position where you want to edit (contact, vertical line, etc.) and enter, change, or delete the ladder symbol or device. Vertical lines, horizontal lines, columns, and rows can be inserted or deleted.

Image of ladder editor

Display device comments
The data stored in RCP, FX5CPU **NEW**, QCPU, and LCP, or the data in an SD memory card of GOT can be displayed.

Change the device number from X10 to X20.

Specification details and restrictions

* For the necessary option devices, please refer to the "Function list" (page 166).

● Target models

RCP*, FX5CPU, QCPU (Q mode)*2, LCP, Motion CPU (Q Series)*3, CNC (C80, C70)

*1 R08PCPU, R16PCPU, R32PCPU, and R120PCPU can be monitored only when the operation mode is the process mode. R08SFPCPU, R16SFPCPU, R32SFPCPU, and R120SFPCPU are not supported by the safety program edit and the device test of programmable controller CPUs.

*2 Excluding the Q02PHCPU, Q06PHCPU, Q12PHCPU, Q25PHCPU, Q12PRHCPU, Q25PRHCPU.

*3 Only the PLC CPU area (CPU No.1) in the Q170MCPUS(S1), Q170MSCPU(S1) can be monitored.

● Supported connection types*1

Ethernet connection*2, direct CPU connection (serial), serial communication connection, CC-Link IE Controller Network connection, CC-Link IE Field Network connection, CC-Link connection, bus connection, MELSECNET connection

*1 For the details of connectable models of each connection type, please refer to the "Connectable model list" (page 170).

*2 When the CC-Link IE Field Network Ethernet adapter module is used, the ladder editor cannot be used.

Recommended industries

Automotive Electronics Plant

Supported GOT types

GT27 GT25 GT23
GT21 GS21 SoftGOT

Supported devices

PLC Servo Inverter
Robot CNC

Support FXCPU maintenance



FX list editor function & FX ladder monitor function

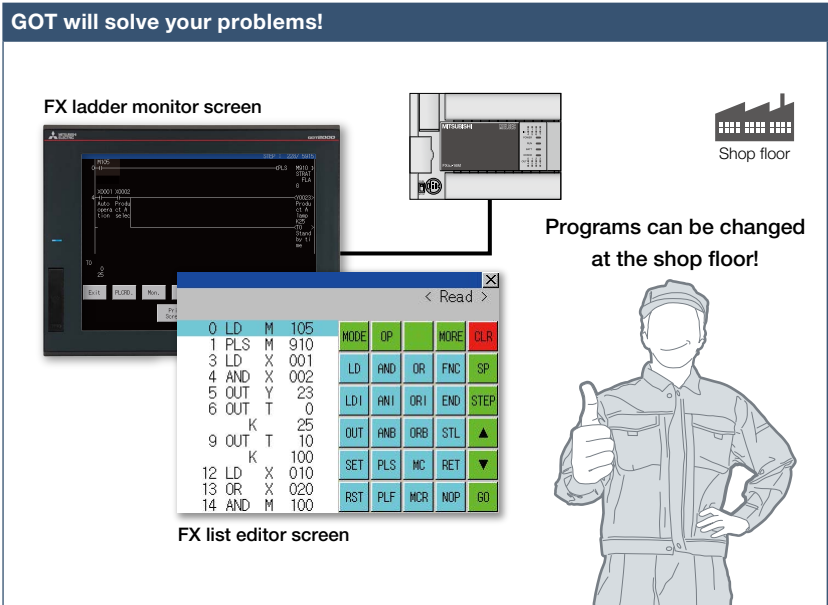
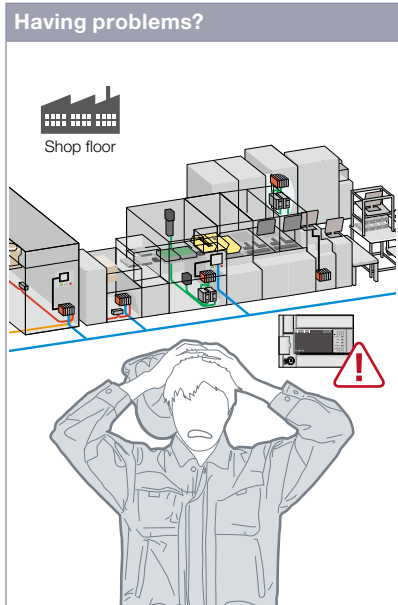

The system has been changed at the shop floor. I need to change sequence programs of the MELSEC-F Series programmable controller.

Sequence programs of the MELSEC-F Series programmable controllers can be edited in the list (command) format. Minor program changes can be applied even without a personal computer or a peripheral device.

Function features

You can easily edit and monitor sequence programs without preparing any peripheral devices other than the GOT.

FX list editor

Just by simple key operations you can check, partially correct, change, or add parameters or sequence programs of an FXCPU.

* Supported by GT2107-W and GT2104-R among GT21.
* Not supported by GT25 wide models.

Example of changing sequence program commands

LD	X000	Change	LD	X000
OUT	Y020	→	OUT	Y030
LD	X001		LD	X001

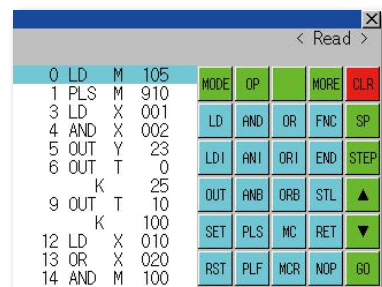
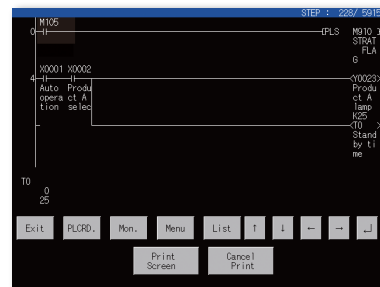

FX ladder monitor

The MELSEC-FX list editor can be opened from the FX ladder monitor screen with a single touch operation. You can edit sequence programs while checking the ladder diagram. You can also display the list screen from the step line displayed in the ladder monitor.

* Not supported by GT23, GT21, and GS21.

Specification details and restrictions

<FX list editor>

- **Target models** FXCPU (FX3U, FX3UC, FX3G, FX3GC, FX3S)
- **Supported connection types***1 Ethernet connection*2, direct CPU connection (serial)
- *1 For the details of connectable models of each connection type, please refer to the "Connectable model list" (page 170).
- *2 When the CC-Link IE Field Network Ethernet adapter module is used, the FX list editor cannot be used.
- **Functions** Writing sequence programs, setting parameters, PLC diagnostics, registering keywords, etc.

Recommended industries

Electronics F & B

<FX ladder monitor>

- **Target models** FXCPU (FX3U, FX3UC, FX3G, FX3GC, FX3S)
- **Supported connection types***1 Ethernet connection, direct CPU connection (serial)
- *1 For the details of connectable models of each connection type, please refer to the "Connectable model list" (page 170).
- **Functions** Search operation, display switching, test operation*2*3, hard copy
- *2 Present values of V and Z cannot be changed.
- *3 Set values of T and C cannot be changed.

Supported GOT types

GT27 GT25* GT23*
GT21* GS21* SoftGOT

Supported devices

PLC Servo Inverter
Robot CNC

* Excluding some models or restrictions apply to some functions. For the details, refer to the function descriptions above.

Visually check logging data



Log viewer function

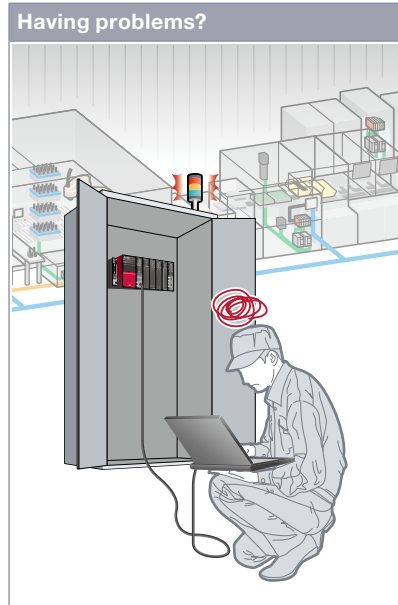

How can I check the logging data collected by programmable controllers without opening a cabinet?

Function features

GOT displays the logging data collected by the data logging function of programmable controller CPUs or other modules.

Quick check of data by multiple cursors

Multiple cursors make it easier to visually check how the data has changed. You can search for the data by specifying the time and index No.

Logging data can be easily changed

FA transparent function (page 83) enables you to view the logging data with GX LogViewer on a personal computer and to change logging settings with CPU Module Logging Configuration Tool.

GOT will solve your problems!

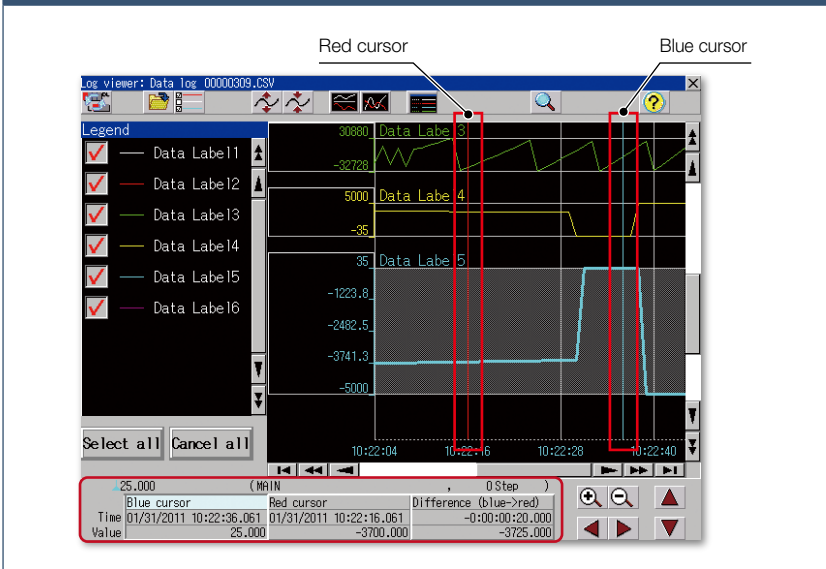

GOT displays the logging data, which achieves quick troubleshooting without using a personal computer at the shop floor.

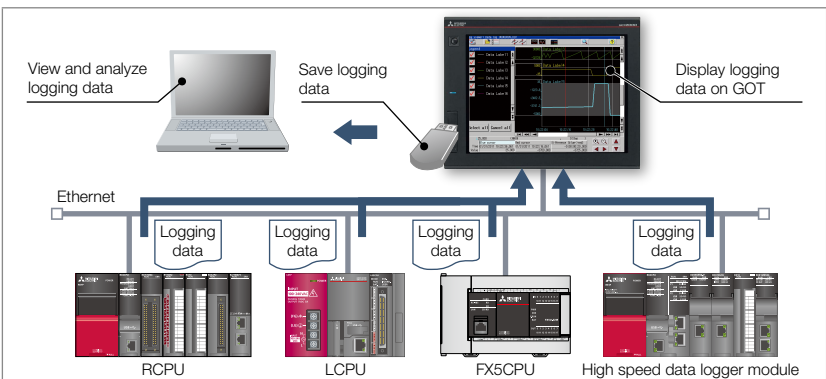

Logging data can be obtained without opening a cabinet

The logging data can be copied to a USB memory device attached to a USB interface on the front (or the backside) of the GOT. It reduces the need to remove a memory card from a CPU or high speed data logger module to retrieve the logging data.

Specification details and restrictions

* For the necessary option devices, please refer to the "Function list" (page 166).

● **Target models** Programmable controller CPU (RCPU^{*1}, QCPU^{*2}, LCPU^{*3}, FX5CPU^{*4}), high speed data logger module (MELSEC iQ-R Series/Q Series), BOX data logger, CNC (C80, C70)

*1 Supported by R01CPU, R02CPU, R04CPU, R08CPU, R16CPU, R32CPU, R120CPU, R04ENCPU, R08ENCPU, R16ENCPU, R32ENCPU, R120ENCPU, R08SFCPU, R16SFCPU, R32SFCPU, R120SFCPU only.
 *2 Supported by Q03UDVCP, Q04UDVCP, Q06UDVCP, Q13UDVCP, Q26UDVCP only.
 *3 Supported by L02CPU, L02CPU-P, L06CPU, L06CPU-P, L26CPU, L26CPU-P, L26CPU-BT, L26CPU-PBT only.
 *4 Restrictions apply to the CPUs. For the details, please refer to the relevant product manual.

● **Supported connection types**^{*1} Ethernet connection^{*2}

*1 For the details of connectable models of each connection type, please refer to the "Connectable model list" (page 170).

*2 R01CPU, R02CPU, R04CPU, R08CPU, R16CPU, R32CPU, R120CPU, R08SFCPU, R16SFCPU, R32SFCPU, R120SFCPU, QCPU, and LCPU are supported via the built-in Ethernet port; R04ENCPU, R08ENCPU, R16ENCPU, R32ENCPU, and R120ENCPU are supported via the port CPU P1.

Recommended industries

Automotive	SEMICON, LCD	Electronics
F & B	Pharma	Plant

Supported GOT types

GT27	GT25	GT23
GT21	GS21	SoftGOT

Supported devices

PLC	Servo	Inverter
	Robot	CNC

In case of PLC error



Backup/Restoration function

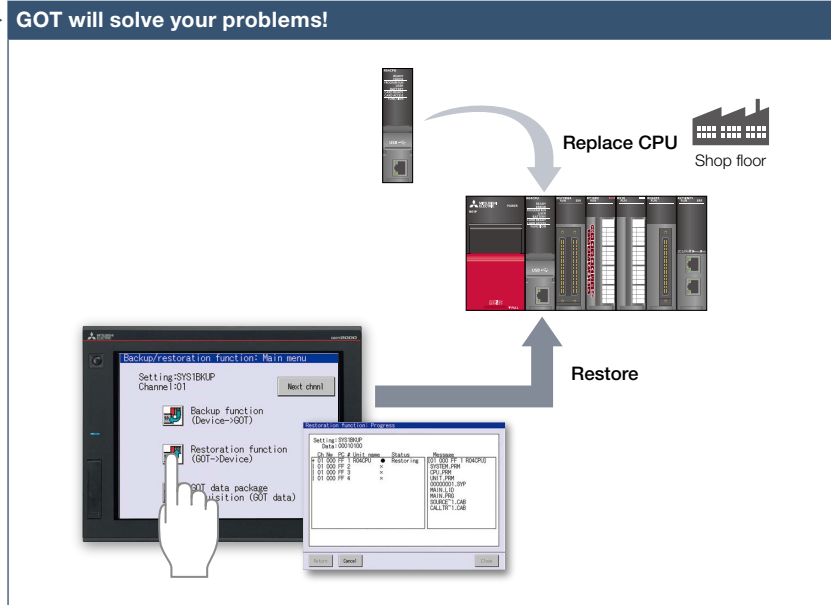
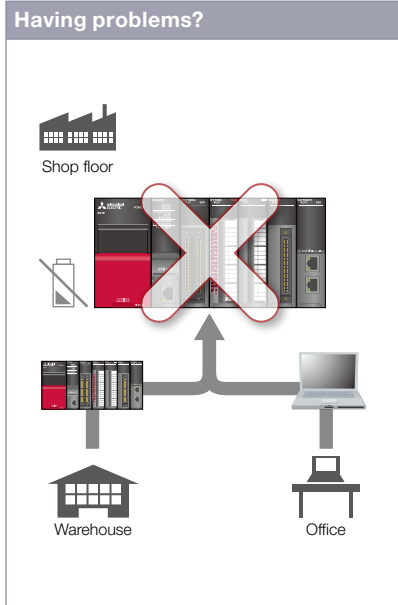

Programmable controller error! The battery is dead! I need to go to the warehouse to get another device and a personal computer to write programs.

There is no need for a personal computer on the production floor. Simply use the GOT to write sequence programs to the controller and you can quickly recover the problem.

Function features

Backup or restore the programs and parameters of programmable controller CPUs or other devices to or from the GOT's SD memory card or USB memory. With a backup of data in the GOT, there's no need to use a personal computer when replacing the industrial devices such as the programmable controller CPU. All replacement and restoration can be completed with just the GOT.

* Excluding GT2103-PMBLS

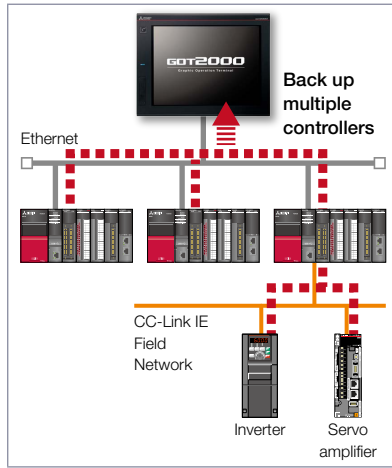

Back up multiple controllers/ Automatic backup

Besides making backup of multiple controllers connected on Ethernet, you can specify a trigger device, a day of the week, and time for automatic backup to reduce the time needed to back up each controller separately.

* Not supported by GT21 and GS21.

Specification details and restrictions

* For the necessary option devices, please refer to the "Function list" (page 166).

● **Target models** RCPUR^{*1*}, QCPU (Q mode) (excluding Q12PRHCPU, Q25PRHCPU), LCPUR, FX5CPU, FXCPU, Motion CPU (MELSEC iQ-R Series/Q Series (SV13/SV22 only))^{*2}, robot controller (FR Series (CR800-R (R16RTCPU), CR800-D), F Series (CR750-Q (Q172DRCPU), CR751-Q (Q172DRCPU), CR750-D, CR751-D), SQ Series CRnQ-700 (Q172DRCPU), SD Series CRnD-700)^{*2}, CNC (C80, C70)^{*2}, inverter (FR-A800/A800Plus/F800 Series)^{*2*}, servo amplifier (MR-J4-□GF)^{*2*}

*1 Excluding R08SFCPU, R16SFCPU, R32SFCPU, R120SFCPU, R08PSFCPU, R16PSFCPU, R32PSFCPU, R120PSFCPU.

*2 Not supported by GT21 and GS21.

*3 Supported only when the GOT and the programmable controller (RCPUR, QCPU, LCPUR) are connected via Ethernet and the programmable controller (RCPUR, QCPU, LCPUR) and the inverter/servo amplifier are connected via the CC-Link IE Field Network.

● **Supported connection types^{*1}** Ethernet connection^{*2}, direct CPU connection (serial), CC-Link IE Field Network connection^{*3}, serial communication connection, bus connection

*1 For the details of connectable models of each connection type, please refer to the "Connectable model list" (page 170).

*2 When the CC-Link IE Field Network Ethernet adapter module is used, the Backup/Restoration function cannot be used.

*3 The connection type between the programmable controller and the inverter/servo amplifier.

● **Target data** Programs, parameters, device comments, device initial values, file registers, etc.

Recommended industries

Automotive	SEMICON, LCD	Electronics
F & B	Pharma	Plant

Supported GOT types

GT27	GT25	GT23
GT21*	GS21*	SoftGOT

Supported devices

PLC	Servo	Inverter
Robot	CNC	

* Excluding some models or restrictions apply to some functions. For the details, refer to the function descriptions above.

Check the PLC module status

Upgraded

System launcher function

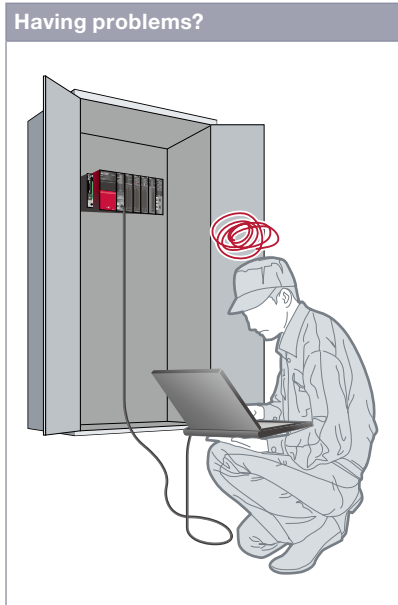

Having problems?

Can I check the status of the programmable controller system without a personal computer?

Function features

The programmable controller system can easily be checked on GOT without a personal computer at the shop floor.

Starting extended function quickly

When you touch a module in the system configuration diagram, the list of extended functions available to the module is shown.

Example of system launcher (servo network)

* See details on page 60

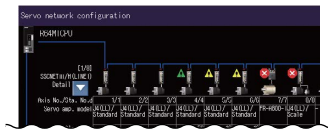

GOT will solve your problems!

System configuration diagram

Icons show the module status. You can check the module with an error at a glance.

Extended function list screen

You can start the extended functions that are supported by the module.

Programmable controller CPU

- PLC diagnostics
- Device monitor
- Sequence program monitor (Ladder)
- Sequence program monitor (SFC)
- Backup/Restore
- iQSS utility

Motion controller

- R motion monitor
- R motion monitor (parameter setting)
- Drive recorder
- System launcher (servo network)**

* See details on page 60

Select module

A graphical configuration diagram indicates module statuses. When you touch a module the extended function list is shown and you can carry out maintenance work efficiently.

Checking module product information

The product information such as production number obtained from modules can be checked in a list.

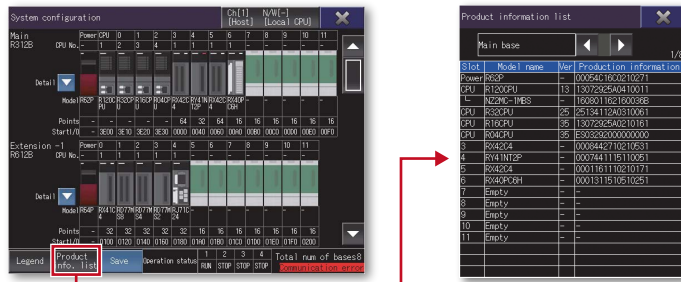

Online module change function

GOT can direct a programmable controller to execute the online module change. (The applicable modules are listed below in this page.)

Specification details and restrictions

- **Target models** RCPU, QCPU (Q mode), LCPU, Motion CPU (MELSEC iQ-R Series/Q Series), CNC (C80, C70), robot controller (FR Series (CR800-R (R16RTCPU), CR800-Q (Q172DSRCPU)), F Series (CR750-Q (Q172DRCPU), CR751-Q (Q172DRCPU)), SQ Series CRnQ-700 (Q172DRCPU))
- **Supported connection types*** Ethernet connection, direct CPU connection (serial), serial communication connection, CC-Link IE TSN connection, CC-Link IE Controller Network connection, CC-Link IE Field Network connection, CC-Link connection, bus connection, MELSECNET connection
- *1 For the details of connectable models of each connection type, please refer to the "Connectable model list" (page 170).
- **Extended functions that can be started from the system launcher** Device monitor, sequence program monitor (iQ-R ladder/Ladder), sequence program monitor (SFC), network monitor, R motion monitor, Q motion monitor, intelligent module monitor, backup/restoration*, R motion SFC monitor, Q motion SFC monitor, CNC monitor 2, CNC monitor, CNC data I/O, CNC machining program edit, iQSS utility, CC-Link IE TSN/CC-Link IE Field Network diagnostics, drive recorder, system launcher (servo network), servo amplifier graph
- *1 The CPU number setting is not transferred. Only the channel of the connected controller is in its selected state.
- **Modules applicable to online module change** QCPU (Q mode) input/output I/O module, analog input/output module, temperature input/temperature control module, loop control module, pulse input module

Recommended industries



Supported GOT types



Supported devices



* Supported by GT SoftGOT2000 (Multiple channels) only.

Graphically monitor the network status

Upgraded

■ CC-Link IE TSN/CC-Link IE Field Network diagnostics



4

GOT Solutions - Maintenance, Troubleshooting and Diagnostics Features

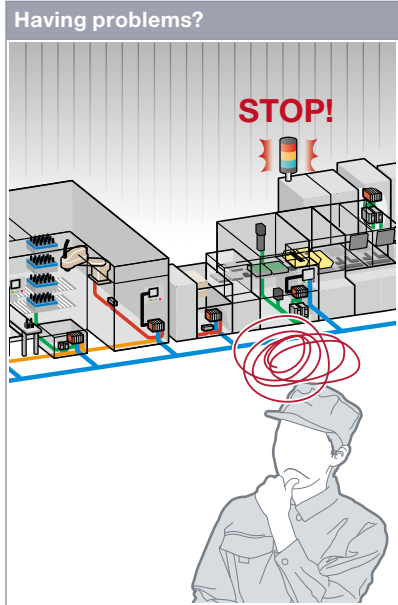

A problem occurred but it might take time to solve it in the large scale system.

Function features

GOT can be used to check the devices in the CC-Link IE TSN **NEW** or CC-Link IE Field Network and identify the error in the network at a glance. If a problem occurs, you can quickly check where the error occurs and reduce downtime.

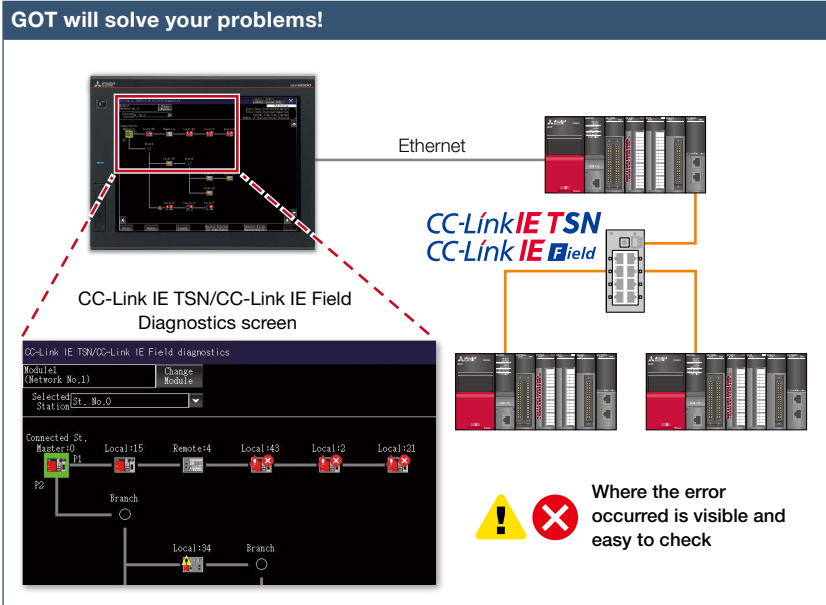

Even in a large scale system that has a complex network configuration, the network status can be checked graphically so that line troubles and module errors can be identified quickly.

Checking event history

This window displays the history of network events and the event details. The event history can be output to a CSV file and used for trouble analysis in your office.
* Supported by the CC-Link IE Field Network diagnostics only. Not available when the connection destination is an RCPUCPU or FX5CPU.

Checking communication status of modules

The communication status can be checked for modules that are selected in the CC-Link IE TSN/CC-Link IE Field Network diagnostics screen. MAC address and IP address can also be checked.

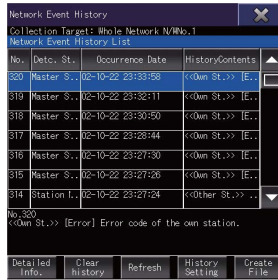

Network event history window

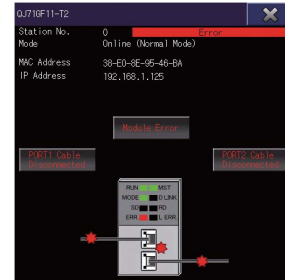

Communication status monitor window

Specification details and restrictions

- **Target models** RCPUCPU**2, QCPU (Q mode) (excluding Q12PRHCPU and Q25PRHCPU)*3, LCPUCPU*3, FX5CPU, C Controller (MELSEC iQ-R Series/Q Series)*3
 - *1 The CC-Link IE TSN/CC-Link IE Field Network diagnostics is not supported by R08PSFCPU, R16PSFCPU, R32PSFCPU, and R120PSFCPU.
 - *2 The CC-Link IE TSN diagnostics is not supported by R08PCPU, R16PCPU, R32PCPU, and R120PCPU. When a redundant system is configured, the CC-Link IE TSN/CC-Link IE Field Network diagnostics is not supported.
 - *3 The CC-Link IE TSN diagnostics is not supported.
- **Supported connection types**1** Ethernet connection**2, direct CPU connection (serial)**3, serial communication connection**4, CC-Link IE TSN connection**5
 - *1 For the details of connectable models of each connection type, please refer to the "Connectable model list" (page 170).
 - *2 Connection to the Ethernet interface module of a programmable controller is not supported.
 - *3 RCPUCPU and FX5CPU do not support direct CPU connection (serial).
 - *4 When using the CC-Link IE Field Network diagnostics, FX5CPU does not support serial communication connection.
 - *5 QCPU (Q mode), C Controller (Q Series), and LCPUCPU do not support CC-Link IE TSN connection.
- **Supported diagnostics items and station types** Available diagnostics items vary depending on the station type (master station, local station, or submaster station). For the details, please refer to the relevant product manual.

Recommended industries



Supported GOT types



Supported devices



Easy debugging

Upgraded

FA transparent function



Support system
startup/
adjustment



It's bothersome to open the cabinet every time I setup or adjust the device. For the safety reason, I don't want to open the cabinet and change cable connections.

Function features

By connecting a personal computer to the front USB interface on the GOT, you can use the GOT as a transparent gateway to enable programming, startup, and adjustment of industrial devices. Users do not have to bother with opening the electrical cabinet or changing cable connections.

Transferring GOT project data via a programmable controller

Transfer data from a personal computer to the GOT2000 with a programmable controller acting as a gateway. Changing project data during startup or maintenance is now easier than ever.

* Not supported by GT21 and GS21.



Without opening the cabinet and by only connecting a personal computer to the front USB interface on the GOT, you can use the GOT as a transparent gateway to enable programming, startup, and adjustment of industrial devices.

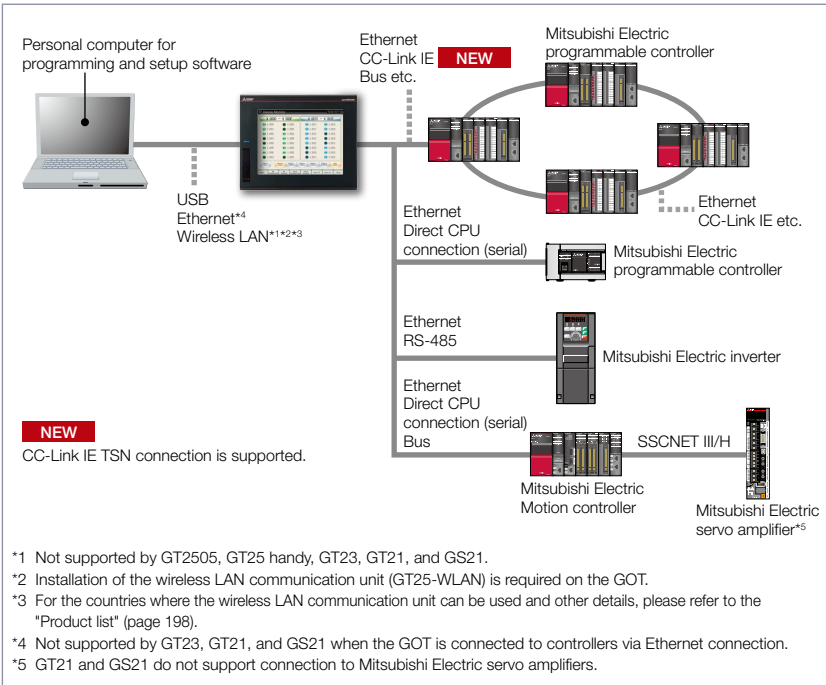

*1 Not supported by GT2505, GT25 handy, GT23, GT21, and GS21.
 *2 Installation of the wireless LAN communication unit (GT25-WLAN) is required on the GOT.
 *3 For the countries where the wireless LAN communication unit can be used and other details, please refer to the "Product list" (page 198).
 *4 Not supported by GT23, GT21, and GS21 when the GOT is connected to controllers via Ethernet connection.
 *5 GT21 and GS21 do not support connection to Mitsubishi Electric servo amplifiers.

Specification details and restrictions

● **Supported devices, connection types, and compatible software** For the details, please refer to the relevant product manual.

Recommended industries

Automotive	SEMICON, LCD	Electronics
F & B	Pharma	Plant

Supported GOT types

GT27	GT25*	GT23*
GT21*	GS21*	SoftGOT

Supported devices

PLC	Servo	Inverter
Robot	CNC	

* Restrictions apply to some functions. For the details, refer to the function descriptions above.

Check status of industrial devices



Device monitor function

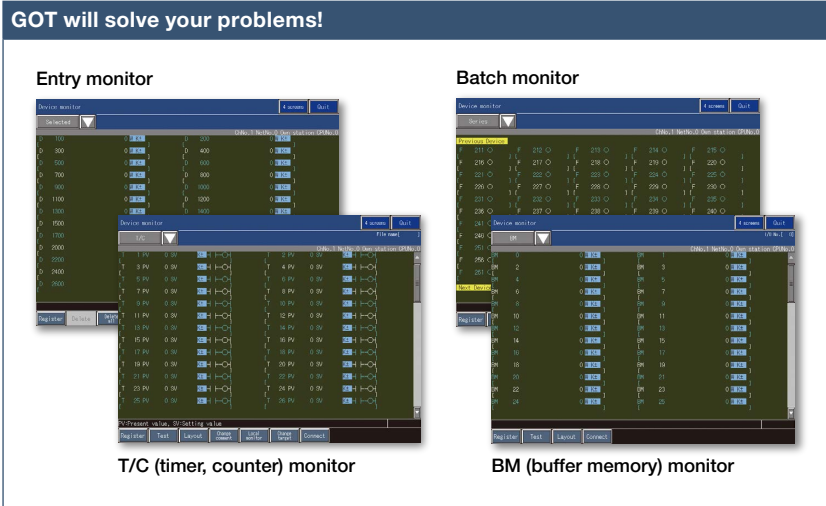

How can I check the status of industrial devices without a personal computer?

GOT can be used to monitor or change device values of programmable controllers, Motion controllers, robot controllers, or CNCs. The function is useful for starting up devices.

* For the details of supported devices and connection types, please refer to the relevant product manual.

Recommended industries

- Automotive
- SEMICON, LCD
- Electronics
- F & B
- Pharma
- Plant

Supported GOT types

- GT27
- GT25
- GT23
- GT21
- GS21
- SoftGOT

Supported devices

- PLC
- Servo
- Inverter
- Robot
- CNC

Network monitor function

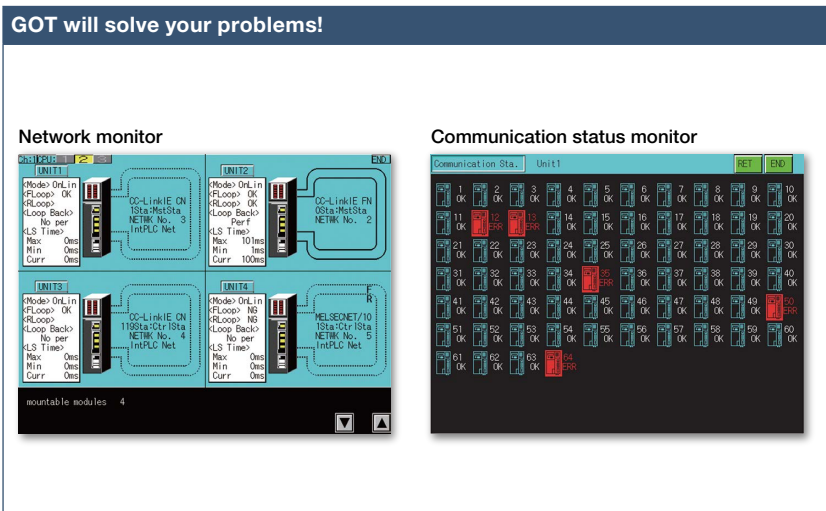
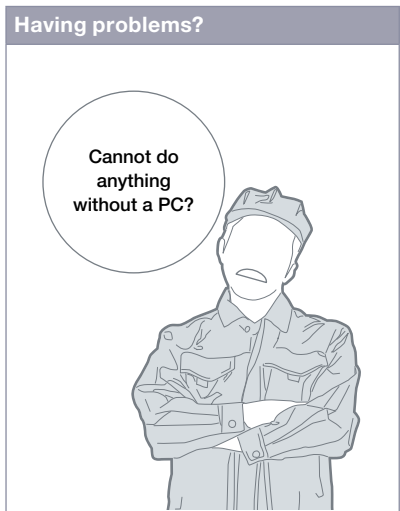

Can I check the network status without a personal computer?

The network monitor function enables the GOT to monitor and display the status of the CC-Link IE TSN, CC-Link IE Controller Network, CC-Link IE Field Network, MELSECNET/H network, and MELSECNET/10 network.

* For the details of supported devices and connection types, please refer to the relevant product manual.

Recommended industries

- Automotive
- SEMICON, LCD
- Electronics
- F & B
- Pharma
- Plant

Supported GOT types

- GT27
- GT25
- GT23
- GT21
- GS21
- SoftGOT

Supported devices

- PLC
- Servo
- Inverter
- Robot
- CNC

Easily identify the cause of alarms



Alarm function

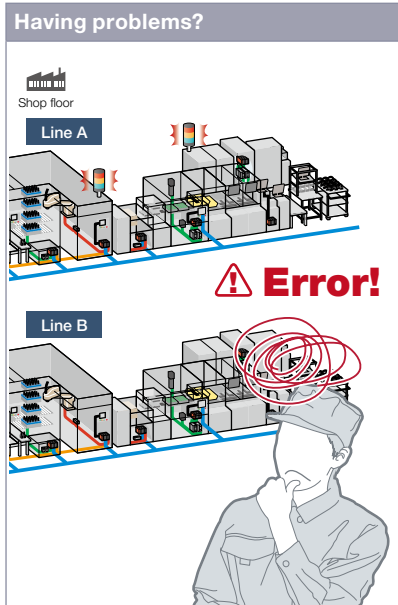

An error occurred! How can I identify the location and quickly recover the problem?

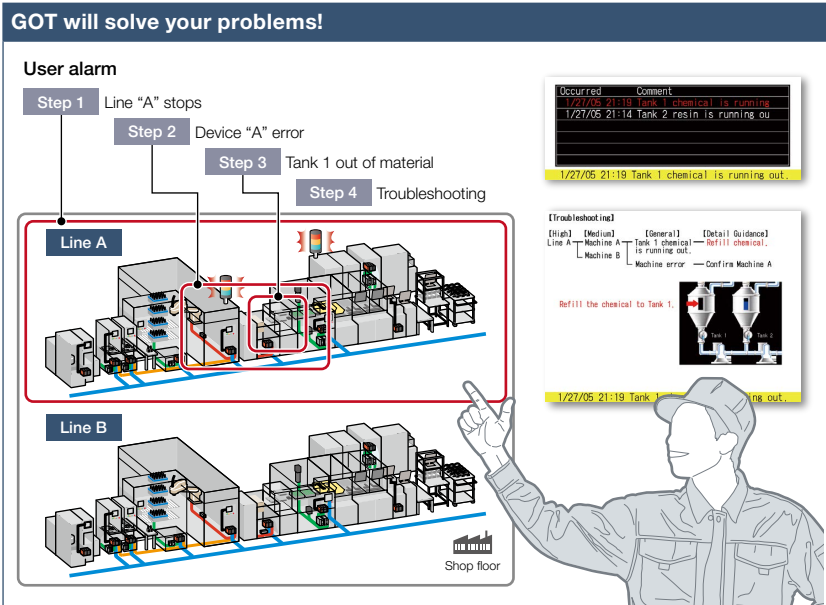

Alarms are displayed with a station No. and CPU No. in the list grouped by system or level. It helps you to identify the location where the error occurred in a large system, leading to quick troubleshooting.

Function features

GOT displays communication errors (system alarms) of controllers and user-created alarms (user alarms).

Easily identify the cause of alarms [System alarm*1]

System alarms are displayed with additional information such as channel No., network No., station No., CPU No., screen No., and object ID. It helps you to identify the controller in which the error occurred and the cause of the alarm.

*1 Not supported by GT21 and GS21.

Alarms grouped by system or level [User alarm]

Alarms are displayed in the list grouped by system or level or all alarms are displayed in one list. You can easily check the detailed information of multiple alarms even in a large system, leading to quick troubleshooting.

Backup of alarm logs during power failure [System alarm*1/User alarm]

Alarm log data can be saved to a built-in SRAM or other data storage even when the power supply has failed.

*1 Not supported by GT21 and GS21.

Interaction with other functions [User alarm]

Use of the alarm function combined with the logging and graph helps you to check the status when the alarm occurred and the status of the error found in the graph.

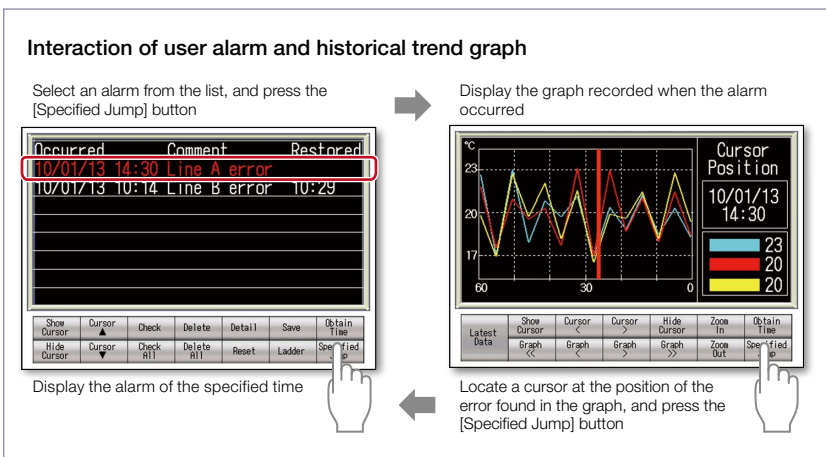

* For the necessary option devices, please refer to the "Function list" (page 166).

Recommended industries

Automotive	SEMICON, LCD	Electronics
F & B	Pharma	Plant

Supported GOT types

GT27	GT25	GT23
GT21*	GS21*	SoftGOT

Supported devices

PLC	Servo	Inverter
Robot	CNC	

* Restrictions apply to some functions. For the details, refer to the function descriptions above.

Quick troubleshooting at shop floor



Document display function

4

GOT Solutions - Maintenance, Troubleshooting and Diagnostics Features

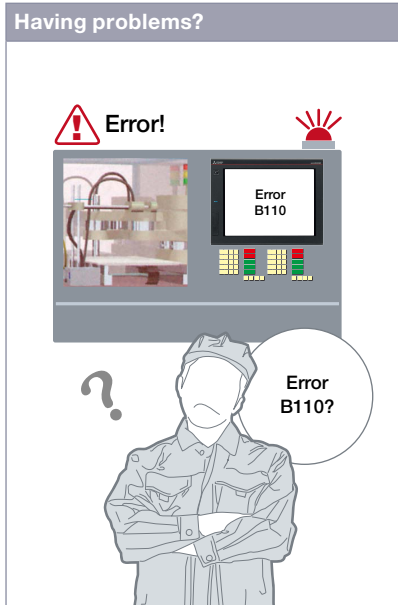

How can I recover from errors?

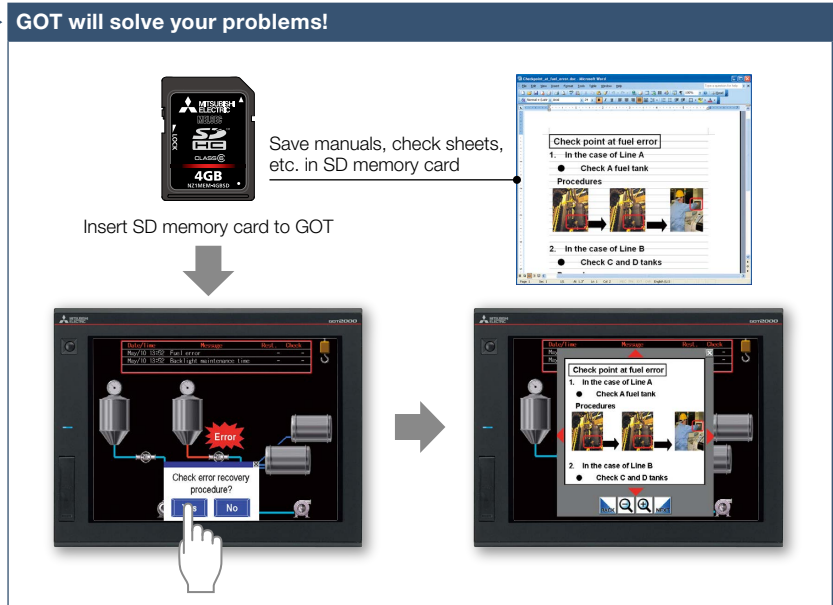

GOT displays manuals or check sheets with instructions on how to restore the system, which reduces the downtime.

Function features

GOT displays various kinds of documents such as manuals. You can switch between pages, scroll, and zoom in/out a page for smooth viewing. Entering a page number easily displays the specified page among multiple pages in the manual.

Indirect specification of document ID or page number

You can switch displayed documents on one screen just by changing the document ID or the page number with objects such as touch switch or numerical input.

Viewing PDF files directly

PDF files can be viewed directly on GOT. With bookmark display and keyword searches, you can instantly check the information you want.

Bookmark display and keyword searches of PDF files

Document display screen

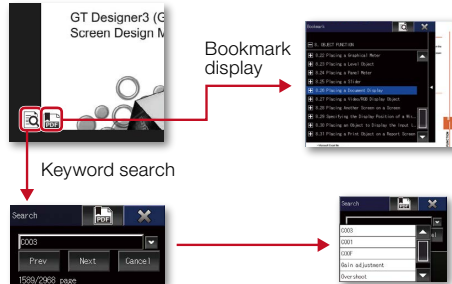

Display the "Bookmark" window and move to the page you want to display from "Bookmark"

Display the search window and enter the keyword to move to a page containing the keyword

Specifying initial display page with keyword

By specifying the initial display page with a keyword, the specified page automatically appears when using the document display function.

Supporting network drive

The network drive can be used as the save destination for the document files to display. Data can be saved without considering the capacity limit.

* For the details, please refer to page 98.

Specification details and restrictions

* For the necessary option devices, please refer to the "Function list" (page 166).

● **Supported file formats** PDF file, DocumentConverter output file*1 (doc, xls, ppt, pdf, jpg, bmp)

*1 Documents should be converted using DocumentConverter that is included in GT Works3.

Recommended industries



Supported GOT types



Supported devices



Quick troubleshooting from your office



GOT diagnostics function

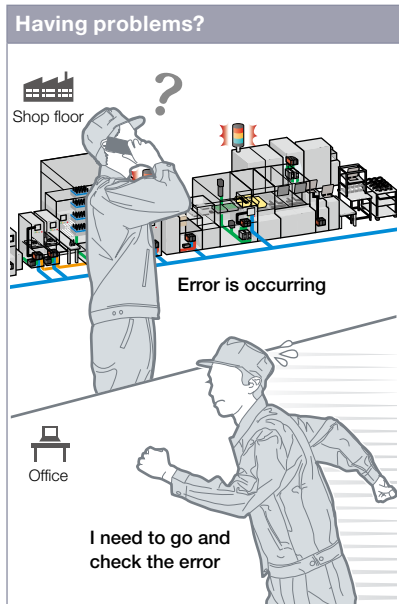

An error occurred at the shop floor. I need to go and check the error quickly.

You do not need to visit the shop floor. The status of GOT and CPU can be monitored using GT Works3 at your office. Check the error cause and corrective actions in detail, and you can solve the problem quickly.

Function features

Without having manuals, you can use GT Works3 and check the cause and corrective actions of system alarms* and script errors.

* Not supported by GT21 and GS21.

Checking system alarms*

GOT errors, CPU errors, net work errors, and corrective actions can be checked. Without using GX Works3/GX Works2, quickly check errors using GT Works3.

* Not supported by GT21 and GS21.

Checking script errors

The error cause and corrective actions of GOT script programs can also be checked, thus enabling efficient work of program fix and machine setup.

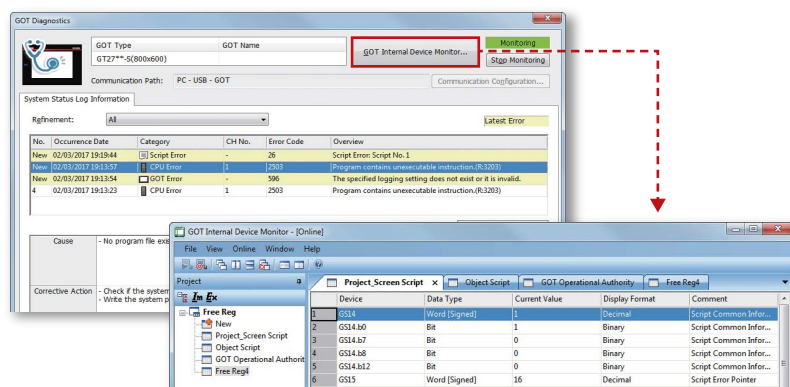

GOT internal device monitor

On GT Works3, you can monitor the GOT internal devices and change the device values as necessary.

Specification details and restrictions

● **Display contents** System alarms** (GOT errors, CPU errors, network errors), script errors (project script, screen script, object script)

** Not supported by GT21 and GS21.

Recommended industries



Supported GOT types



Supported devices



* Restrictions apply to some functions. For the details, refer to the function descriptions above.

Support various international standards



Compatible with environmental standards

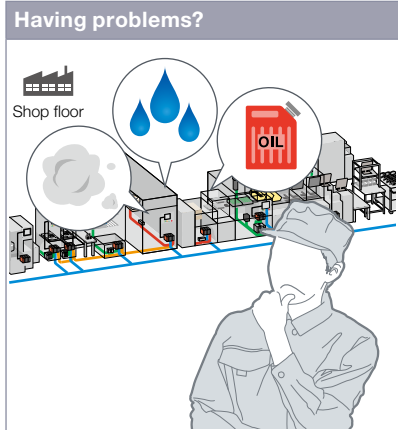

I want to use an HMI which is designed to be safely used in hazardous locations.

GOT has been approved as the environmentally-resistant equipment, which means that the GOT can be used in various locations.

Function features

GOT is acceptable for use in hazardous locations classified by various safety standards (Class I, Division 2 [the United States, Canada], ATEX [the EU member states, the United Kingdom], KCs [Korea]). Since GOT conforms to water, dust, and oil-proof IP67F standard, it is acceptable for use in areas where water or oil are present.

* GT25 rugged model conforms to IP66F.

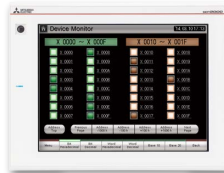

Approved use in hazardous locations

GOT complies with safety standards of the United States, Canada, Europe, and Korea. (White model only)



Water, dust, and oil-proof

IP67F for the front surface. GOT is acceptable for use in areas where water or oil are present.

* GT25 rugged model conforms to IP66F.

Approval standards list (as of June 2023)

* For the latest information, please contact your local sales office.

O: Supported x: Not supported

Approval standards			Standard model (panel color: black)	White model (panel color: white)		GT25 open frame model	GT25 wide model GT25 rugged model GT21 wide model
Mark	Overview	Country/ Region	GT27/GT25 GT23/GT21/GS21	GT27□□-□TWA GT25□□-□TWA	GT27□□-□TWD GT25□□-□TWD	GT25□□F-□TNA GT25□□F-□TND	GT2512-WXT□D GT2510-WXT□D GT2507-WT□D GT2507T-WTBD GT2107-WT□D
CE	EMC Directive harmonized standards, Low Voltage Directive harmonized standards, RoHS Directive harmonized standards	EU member states	O	O	O	O	O
Ex	ATEX Directive harmonized standards*1	EU member states	x	x	O	x	x
UKCA	EMC Directive harmonized standards, Low Voltage Directive harmonized standards, RoHS Directive harmonized standards ATEX Directive harmonized standards*1	United Kingdom	O	O	O	O	O
			x	x	O	x	x
UL	Safety standards Class I, Division 2	United States	O	O	O	O	O
			x	O	O	x	x
cUL	Safety standards Class I, Division 2	Canada	O	O	O	O	O
			x	O	O	x	x
KC	EMC standards	Korea	O	O	O	O	O
KCs	Safety standards*1	Korea	x	x	O	x	x

*1 To comply with ATEX directive and KCs regulation, there are some restrictions. Please refer to the specification details and restrictions below.

Specification details and restrictions

- **Class I, Division 2** This classification means that the equipment has been approved for use in Class I, Division 2 hazardous locations.
- **ATEX directive and KCs regulation** GOT is acceptable for use in hazardous locations classified by these safety standards. To comply with the ATEX directive and KCs regulation, protective sheet and special fitting in the "Product list" are required separately. (Only protective sheet is required for GT2508-VTWD.) Communication units and option units cannot be used. When using these units, GOT does not comply with the standards. For the details, please refer to the Technical Bulletin "GOT2000 Series in Compliance with the ATEX Directive and KCs Certification Requirements" (No. GOT-A-0101) on the Mitsubishi Electric Factory Automation Global website.
- **IP67F** To conform to IP67F, close the USB environmental protection cover by pushing in the [PUSH] mark or the USB mark firmly to lock the cover*1. Note that the structure does not guarantee protection in all users' environments. The GOT may not be used in certain environments where it is subjected to splashing oil or chemicals for a long period of time or soaked in oil mist.

*1 Open frame models conform to IP67F with the environmental protection sheet attached.

Wireless communication between GOT and PC



Wireless LAN communication unit

Having problems?

No cables to connect GOT and a personal computer...

GOT will solve your problems!

Install the wireless LAN communication unit (GT25-WLAN) on the GOT

How do I connect GOT and a personal computer without using a cable?

The wireless LAN connection between GOT and a personal computer is supported.*¹*²*³ Project data transfer, FA transparent function, GOT Mobile function, and other functions can be used.

- *1 Installation of the wireless LAN communication unit (GT25-WLAN) is required on the GOT.
- *2 Not supported by GT2505 and GT25 handy because the wireless LAN communication unit cannot be installed on these models.
- *3 Access point mode is supported by GT Works3 Ver.1.144A or later. No access point is required separately for direct communication between GOT and mobile devices.

Specification details and restrictions

* For the necessary option devices, please refer to the "Function list" (page 166).

- **Use in wireless LAN connection** Data transfer in the wireless LAN communication may not be as stable as that in the cable communication. A packet loss may occur depending on the surrounding environment and installation location. Make sure to check that it operates properly before using.
- **Country applicable to wireless LAN communication unit** Please refer to the "Product list" (page 198).

Recommended industries

Automotive	SEMICON, LCD	Electronics
F & B		

Supported GOT types

GT27	GT25*	GT23
GT21	GS21	SoftGOT

* Excluding some models. For the details, refer to the function descriptions above.

Design secure network configuration



Ethernet communication unit

Having problems?

I want to separate the network for security reason.

GOT will solve your problems!

Two Ethernet ports physically separate the information system network in the office from the control system network at the shop floor; therefore the network architecture is more reliable and secure.

I want to separate the network for security reason.

Two Ethernet ports physically separate the information system network in the office from the control system network at the shop floor; therefore the network architecture is more reliable and secure.

- * Installation of the Ethernet communication unit (GT25-J71E71-100) is required on the GOT.
- * GT25 wide and GT25 rugged models have two Ethernet ports as standard so that the Ethernet communication unit is not required.
- * Not supported by GT2505 and GT25 handy because the Ethernet communication unit cannot be installed on these models.

Specification details and restrictions

* For the necessary option devices, please refer to the "Function list" (page 166).

- **To use Ethernet communication unit** To use the Ethernet communication unit, the BootOS version Z or later is required. Because the unit cannot be used depending on the connection destination, please refer to the GOT2000 Series Connection Manual.

Recommended industries

Automotive	SEMICON, LCD	Electronics
F & B	Pharma	Plant

Supported GOT types

GT27	GT25*	GT23
GT21	GS21	SoftGOT

* Excluding some models. For the details, refer to the function descriptions above.

Implement the sound notification system easily



■ Sound output function



How can I check the equipment status from a remote location?

Function features

The sound can be output* from the audio equipment such as a speaker that is connected to GOT. The sound can be played when the trigger action or time action conditions are satisfied or touch switches are touched.

* GT25 wide and GT25 rugged models have a built-in sound output interface so that the sound output unit (GT15-SOUT) is not required. The unit is required for other models.

* To output sound, it is required to create sound files.

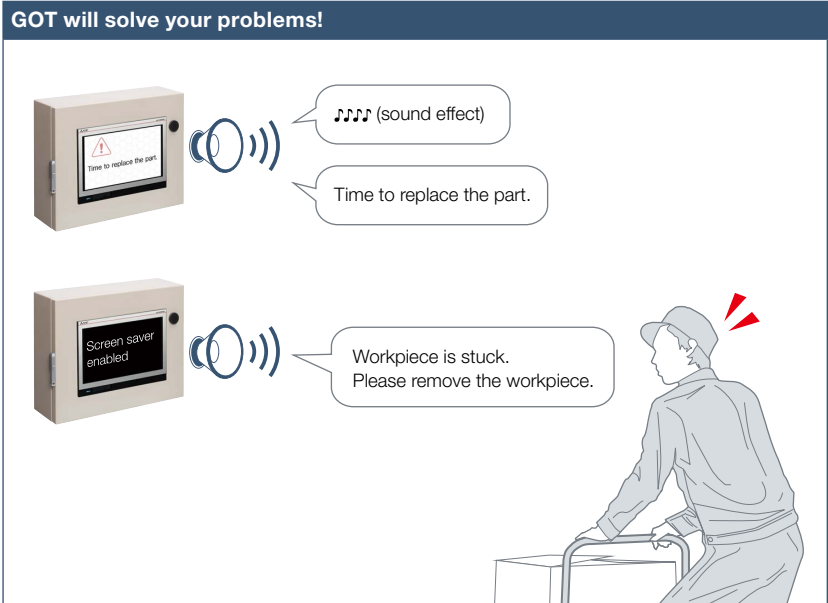

GOT can be used to output sound data. Outputting a notification sound can reliably convey the information to the operators who are working away from the GOT. It is also usable while screen saver is active.

Sound files can be created easily (See page 136)

There are three types of sound files: messages, sound effects, and melodies. Messages can easily be created by using the speech synthesis function* (page 136). Sound effects and melodies are included in GT Works3 so that you can reduce time for system design.

* GT Works Text to Speech License (SW1DND-GTVO-M) is required separately.

Sound files

Message	Sound effect
Create from arbitrary text	More than 50 files are included
Melody	
More than 10 files are included	

Cancel or mute the sound while it is being played back

After checking the situation, you can stop or mute the sound while it is being played back so that you do not need to worry about annoying other operators.



Specification details and restrictions

* For the necessary option devices, please refer to the "Function list" (page 166).

- **Unit installation** GT25 wide and GT25 rugged models have a built-in sound output interface so that the sound output unit (GT15-SOUT) is not required. The unit is required for other models.
- **Sound file specifications** Sound file format: WAV format, sampling frequency: 8.000 kHz/16.000 kHz, channel number: 1 channel (monaural)
- **Applicable plug** φ3.5 stereo mini-plug (3-prong)

Recommended industries

Automotive	SEMICON, LCD	Electronics
F & B	Pharma	Plant

Supported GOT types

GT27	GT25*	GT23
GT21	GS21	SoftGOT

* Not supported by GT2505 and GT25 handy models.

Easy and neat to install

NEW

Panel Mount HMI Speaker * Manufactured by MITSUBISHI ELECTRIC ENGINEERING COMPANY LIMITED



Having problems?

Can I install a speaker easily and neatly?

GOT will solve your problems!

For mounting a sound output unit (GT15-SOUT) on the extension interface of the GOT

- GT27 models
- GT25 models*1
- GT25 open frame models

Are there any ways to easily build a sound notification system?

Attaching the speaker from the front and back of the panel completes the installation. Using the speaker with the sound output function of GOT2000 makes it easy to build a sound notification system.

*1 GT25 wide and GT25 rugged models have a built-in sound output interface so that the sound output unit (GT15-SOUT) is not required. Not supported by GT2505 and GT25 handy models because the sound output unit (GT15-SOUT) cannot be installed on these models.

Specification details and restrictions

● **Panel Mount HMI Speaker specifications** For detailed specifications, please refer to the user's manual of the speaker. For the user's manual, please contact your local sales office of MITSUBISHI ELECTRIC ENGINEERING COMPANY LIMITED.

Recommended industries

Automotive	SEMICON, LCD	Electronics
F & B	Pharma	Plant

Supported GOT types

GT27	GT25*	GT23
GT21	GS21	SoftGOT

* Excluding some models. For the details, refer to the function descriptions above.

A new sanitation management method

NEW

Antibacterial/Antiviral Protective Sheet



Having problems?

What can I do for anti-virus protection?

GOT will solve your problems!

Antibacterial/Antiviral Protective Sheet
GT25-□□PSAC

Anti-Virus
Reduce the number of specific viruses on the product surface by 99.99%

Anti-Bacteria
Suppress the growth of bacteria on the product surface to 1/100 or less compared to no anti-bacterial treatment products

We need to improve sanitation conditions at the shop floor. Multiple operators touch the operation panel so it must be kept clean and safe.

The antibacterial/antiviral protective sheet protects the GOT screen from scratches and dirt, while protecting the operation surface from bacteria and viruses. The clear protective sheet has excellent transparency and does not reduce the brightness of the GOT screen.

Specification details and restrictions

● **Antibacterial/Antiviral Protective Sheet specifications** The general specifications of the antibacterial/antiviral protective sheet are the same as those of the GOT. For the details of the antibacterial/antiviral protective sheet, please refer to the GOT2000 Series Antibacterial/Antiviral Protective Sheet for GT27/GT25 User's Manual (IB(NA)-0800666).

Recommended industries

Automotive	SEMICON, LCD	Electronics
F & B	Pharma	Plant

Supported GOT types

GT27	GT25*	GT23
GT21	GS21	SoftGOT

* Excluding GT25 wide, GT25 open frame, GT25 rugged, and GT25 handy models.

Quick changeover



■ Recipe function

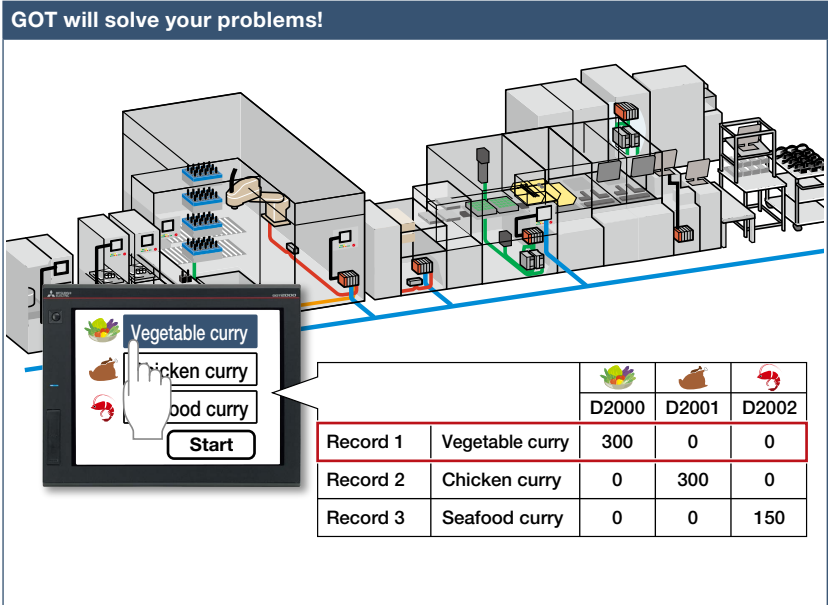
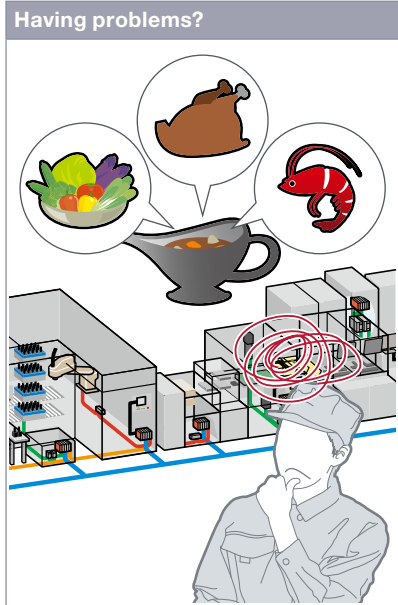

How can I change the recipe information such as material blend and machine conditions?

GOT saves recipe information for individual product. You can select a recipe to be written to the programmable controller, which achieves the quick changeover for the production line.

Function features

GOT saves the recipe information (device values) such as material blend and machine conditions. You can change the recipe on the GOT and write it to a programmable controller to quickly perform the changeover.

Checking record values before recipe change

Without writing records to programmable controllers, record values can be checked and changed. By overwriting a recipe file with the changes, the changed values can be written to devices in programmable controllers. (Recipe special control)
 * Not supported by GT21 and GS21.

Recipe function can be used without data storage

Data storage or SRAM user area can be specified as the save destination of recipe data.

Easy changeover

Changing recipes (changeover) is easy on a user-created screen or on the utility screen.

Change recipes in the utility screen*1	Change recipes from user-created screens	
	Recipe operation window*1	Recipe display (record list)
Secured by setting passwords to activate the utility screen.	Without creating recipe change screen, recipes can be changed by using a standard recipe operation window.	Record selection screen can be created by the users. Various functions and designs are available.

*1 Not supported by GT21 and GS21.

Specification details and restrictions

- Supported device formats Bit, BIN, BCD, Real, String
- Supported formats of recipe file conversion CSV file, Unicode® text file, G2P file

* For the necessary option devices, please refer to the "Function list" (page 166).

Recommended industries

- Automotive
- SEMICON, LCD
- Electronics
- F & B
- Pharma
- Plant

Supported GOT types

- GT27
- GT25
- GT23
- GT21*
- GS21*
- SoftGOT

Supported devices

- PLC
- Servo
- Inverter
- Robot
- CNC

* Restrictions apply to some functions. For the details, refer to the function descriptions above.

Support recipe setting (record) selection



■ Recipe display (record list)

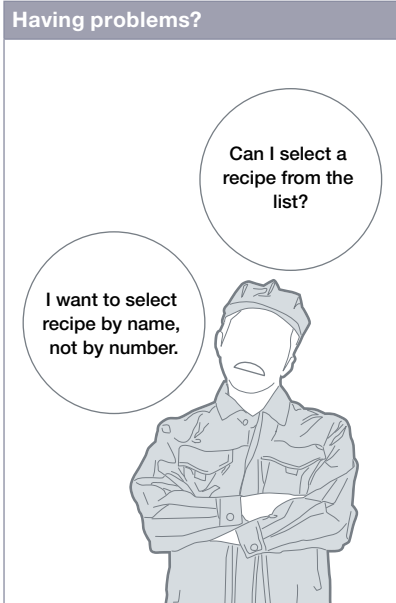

GOT will solve your problems!

GT Works3

Create the list from the recipe setting dialog

Select your favorite style from the preset list and easily create appropriate screen!

Easy to view recipe display

How can I change recipes easily on a user-created screen?

Recipe names (record names) are displayed in a list format on GOT. Sort or narrow down the list and easily change recipes on GOT.

Function features

Create the recipe display (record list) easily just by selecting required items in GT Works3. Colors, line styles, and borders can be changed as you need.

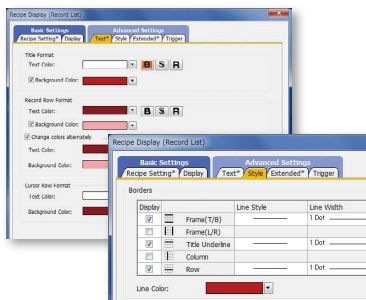

Colors, line styles, and borders can be changed as you need!

Read and write records

Just select a record and touch a switch on GOT and you can easily read or write records.

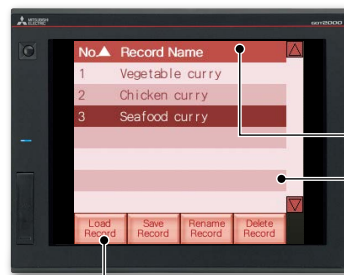

Touch switches for various recipe operations

Change display order of records

Records can be sorted by record number or record name by touching the column header.

Change or delete record names

Change record names or delete records by specifying the record name using text input.

Touch and sort records

Scroll the list by slide operation

Specification details and restrictions

- **Customizable settings** Text color, background color, cursor color, ruled line color, line type, line width, show/hide scrollbar, etc.
- **Functions that can be used with recipe display (record list) object** Read/write records, delete records, verify records, change/sort/filter record names, export/import recipe data
- **How to obtain sample screens** Sample screens are included in GT Works3. For the details, please contact your local sales office. The sample screens are supported by the following GT Works3 versions: Ver.1.155M or later.

Recommended industries



Supported GOT types



Supported devices



Increase efficiency of maintenance work



Writing resource data

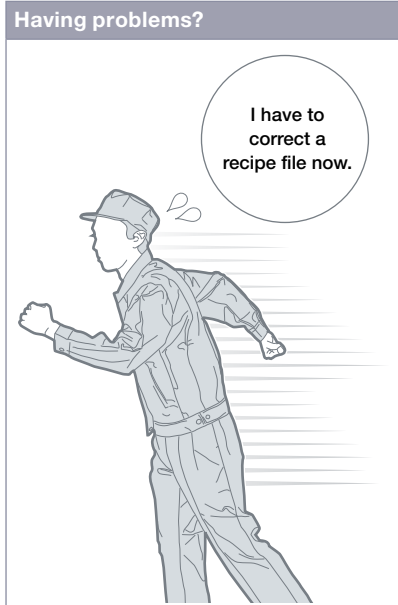

How can I correct recipe files in GOT without visiting the shop floor?

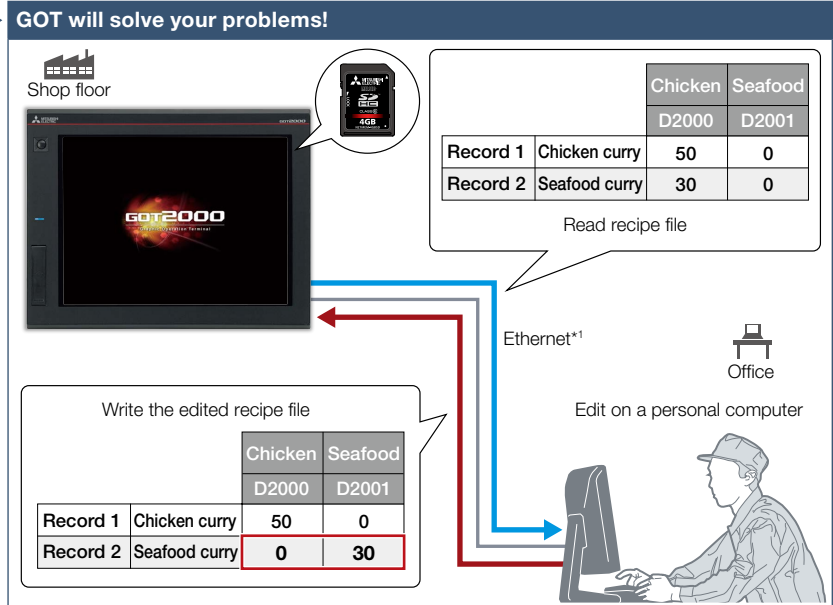

Recipe files read from GOT can be edited and written back to an SD memory card in the GOT or other data storage. Without ejecting the SD memory card, you can read, edit, and write recipe files in your office.

*1 USB can also be used between a personal computer and GOT.

Function features

Resource data (alarm log file, recipe file, logging file, operation log file, image file, and so on) can be written to GOT. There is no need to eject and insert an SD memory card.

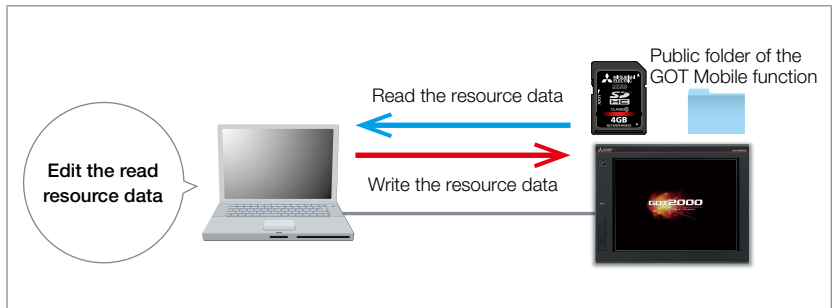

Using the public folder of the GOT Mobile function

Resource data can be saved to the public folder of the GOT Mobile function. By using the public folder as the storage destination, resource data can be written to or read from a personal computer where GT Works3 is not installed.

Specification details and restrictions

● **Transferable resource data** The data that can be transferred differ depending on the GOT model. In addition, the resource data cannot be written depending on the data type. For the details, please refer to the GT Designer3 (GOT2000) Screen Design Manual.

Recommended industries

- Automotive
- SEMICON, LCD
- Electronics
- F & B
- Pharma
- Plant

Supported GOT types

- GT27
- GT25
- GT23
- GT21*
- GS21*
- SoftGOT

Supported devices

- PLC
- Servo
- Inverter
- Robot
- CNC

* Restrictions apply to some functions. For the details, please refer to the GT Designer3 (GOT2000) Screen Design Manual.

Protect valuable assets



Various security functions

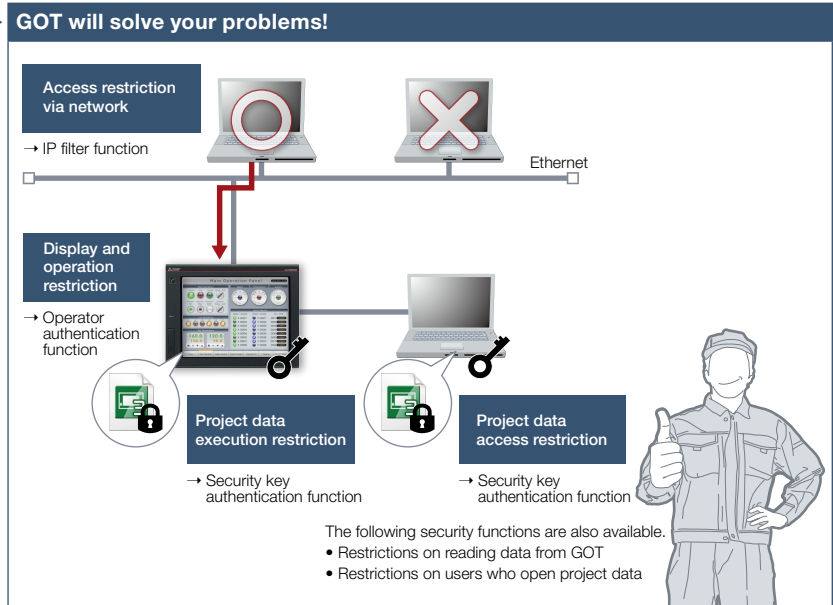

I know the importance of security functions to protect valuable assets, but how can I do...?

To protect customers' assets, GOT offers enhanced security functions such as access restriction on project data and access restriction via network.

Function features

Security key authentication function and IP filter function offer enhanced security.

Prevent data alteration and duplication [Security key authentication function]

On the GOTs and personal computers without registered security keys, the project data cannot be opened and executed, which protects your techniques (know-how) from information leaks.

* Not supported by GT21 and GS21.

Reduce risk of unauthorized access through network [IP filter function]

Registering the IP address of the device which can access the GOT restricts the access from unauthorized devices.

Security key authentication function

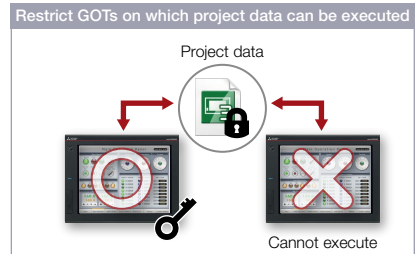
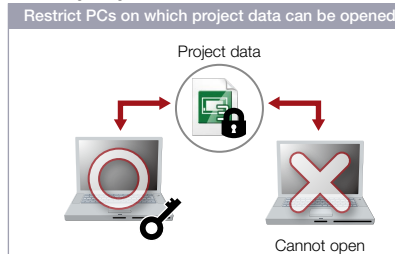

IP filter function

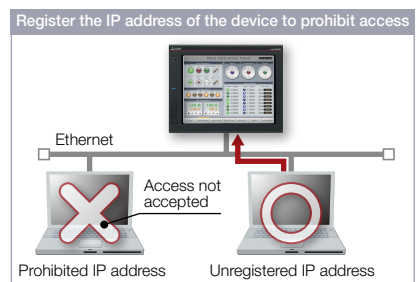
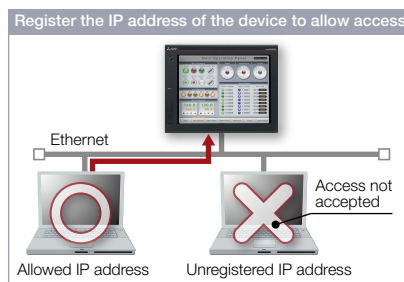

Recommended industries

Automotive	SEMICON, LCD	Electronics
F & B	Pharma	Plant

Supported GOT types

GT27	GT25	GT23
GT21*	GS21*	SoftGOT

Supported devices

PLC	Servo	Inverter
	Robot	CNC

* Restrictions apply to some functions. For the details, refer to the function descriptions above.

Identify error cause based on history information



■ Operation log function

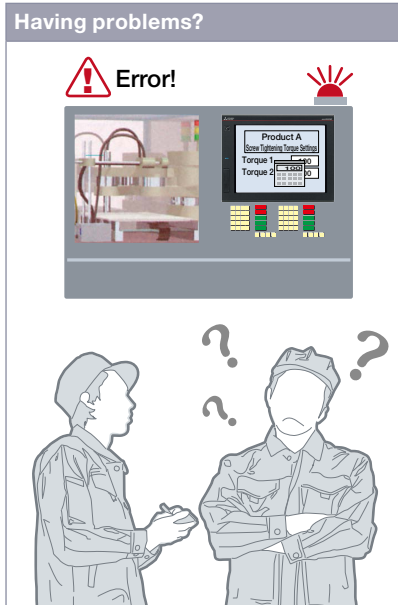

GOT will solve your problems!

Operation log list*1

Check the brief information of the log

Detailed information*1

Check the detailed information of the log

*1 Not supported by GT21 and GS21.

An error occurred due to improper operations, but I do not exactly know why the error occurred...

GOT records all the operations performed by operators. Checking the recorded operation history helps you to identify and analyze the cause of the error occurred due to improper operations, leading to making improvements, preventing reoccurrence, and enhancing traceability.

Function features

GOT records the operation information, such as the “what, when, and how” of an operation performed, in chronological order in an SD memory card or USB memory.

Use of the operation log function combined with the operator authentication function (page 97) records additional information of “who” performed the operation.

* Supported by GT2107-W only among GT21 models.

Easy management for operation log file*1

You can copy and delete an operation log file created by the operation log function and change a file name on GOT without using a personal computer.

The operation log file can be converted into a CSV file or Unicode® text file so that the file can be checked on the personal computer.

*1 Supported by GT2107-W only among GT21 models. Changing file name is not supported by GT2107-W and GS21.

Quick check of operation log file

You can select a log from the operation log list and check the detailed information*1. Screen images*2 also help you to identify the improper operation.

*1 Not supported by GT21 and GS21.

*2 Not supported by GT21, GS21, and GT SoftGOT2000.

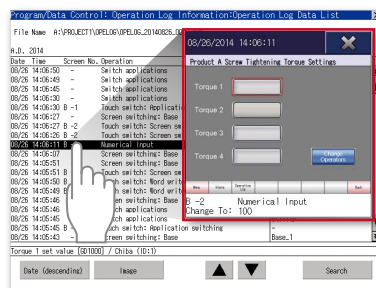

Coordination with user-created management systems

The operation log records not only the operator names that are used in the operator authentication function but also the character strings stored in an external device. It is easy to coordinate your own user management system and the GOT's operation log.

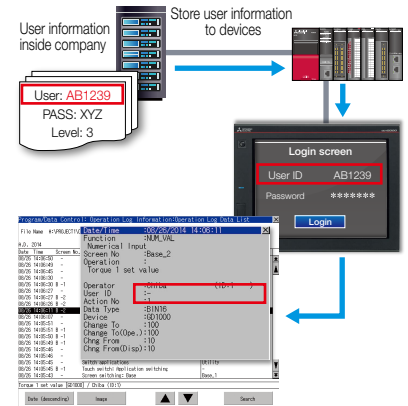

<The example image shows GT27/GT25>

Recommended industries

- Automotive
- SEMICON, LCD
- Electronics
- F & B
- Pharma
- Plant

Supported GOT types

- GT27
- GT25
- GT23
- GT21*
- GS21*
- SoftGOT*

Supported devices

- PLC
- Servo
- Inverter
- Robot
- CNC

* Excluding some models or restrictions apply to some functions. For the details, refer to the function descriptions above.

* For the necessary option devices, please refer to the “Function list” (page 166).

Security with password management



Support system
operation

Upgraded

Operator authentication function

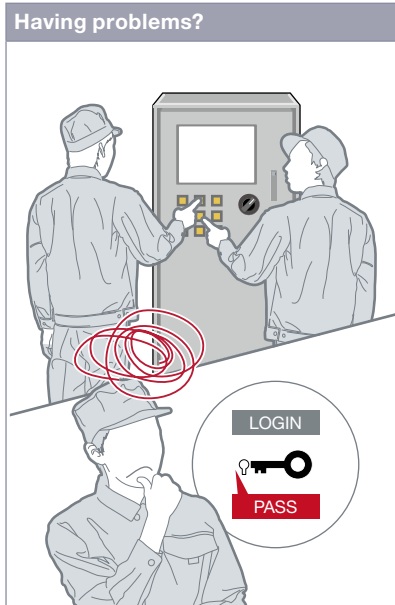

How can I restrict the unauthorized operators?

Function features

Setting the operation authority and the viewing authority achieves “enhanced security” and allows “access management per operator”. Use of the operator authentication function combined with the operation log function (page 96) enables you to check the “who, what, when, and how” of an operation performed.

Enhanced password security

By setting password requirements (the minimum number of characters and the character types), you can set more advanced passwords. It is possible to prompt a password change at the initial login or notify the password expiration date in advance (1 day to 30 days). In addition, supported the function to prohibit the setting of passwords that were used in the past. **NEW**

* Not supported by GT21 and GS21.

GOT will solve your problems!

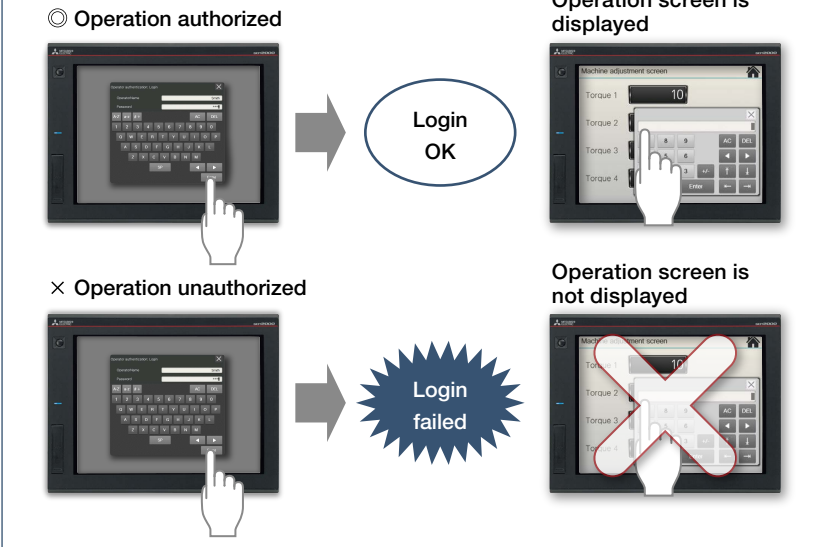

Operator name and password enable the secure login management in a large-scale shop floor, providing the flexibility of setting the operation authority per shop floor or operator. In addition, the login management can be performed by an external authentication device such as RFID.

How to authenticate the operator

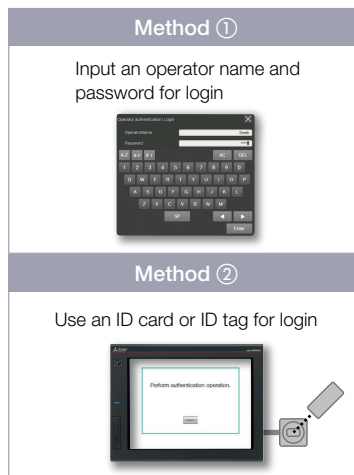

Use of method ① combined with method ② is acceptable. Secure login management is achieved even when an external authentication device has failed.

Settings for operation authority

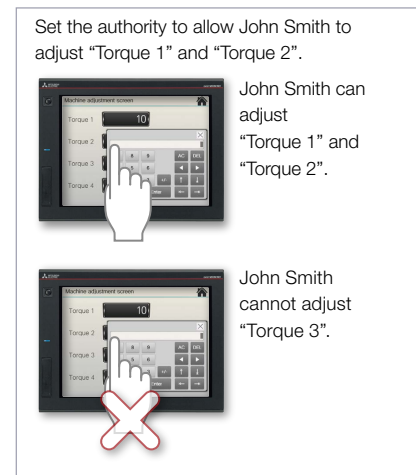

Set the authority to allow John Smith to adjust “Torque 1” and “Torque 2”.

John Smith can adjust “Torque 1” and “Torque 2”.

John Smith cannot adjust “Torque 3”.

* For the necessary option devices, please refer to the “Function list” (page 166).

Recommended industries

Automotive	SEMICON, LCD	Electronics
F & B	Pharma	Plant

Supported GOT types

GT27	GT25	GT23
GT21*	GS21*	SoftGOT

Supported devices

PLC	Servo	Inverter
	Robot	CNC

* Restrictions apply to some functions. For the details, refer to the function descriptions above.

Saving files in network drive



Network drive

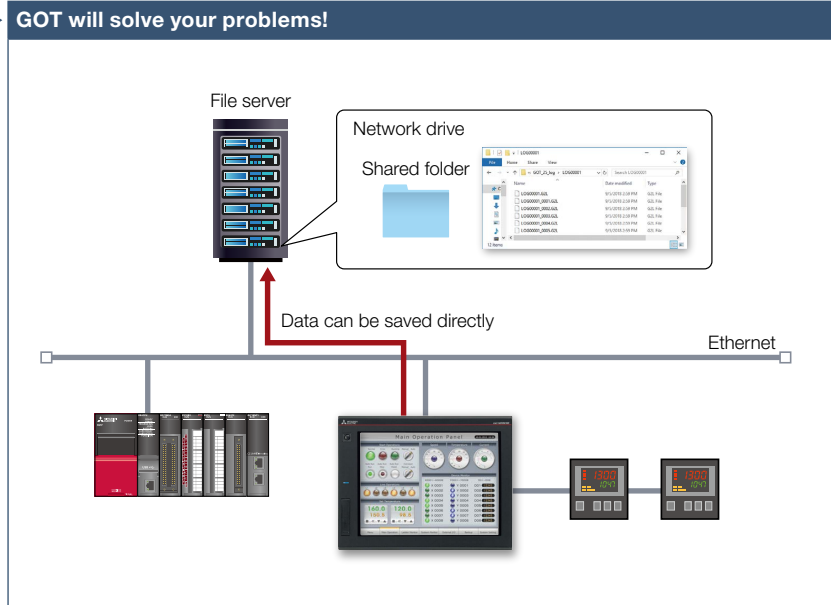
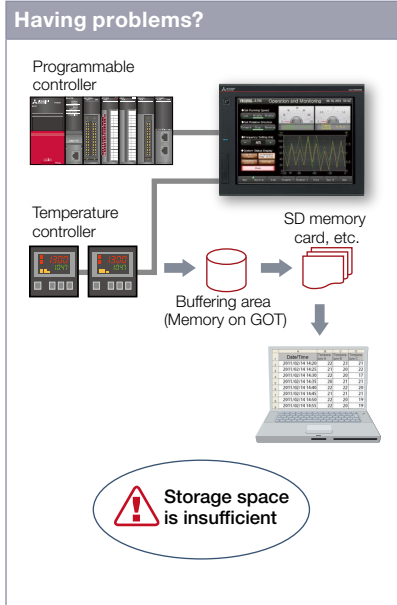

As the size of the logging files and other data saved in the GOT increases, the memory capacity soon becomes insufficient.

Since GOT files can be saved directly to the shared folder on the file server (personal computer) connected by Ethernet, data can be accumulated without considering the GOT memory size or the SD memory card capacity.

Function features

The network drive can be used as the save destination for the GOT files. By setting the shared folder on the file server (personal computer) connected by Ethernet as the network drive, the files can be saved directly to the shared folder from the GOT. Use the external storage to accumulate data without considering the GOT memory size or the SD memory card capacity.

Saving all data to file server

Since files can be saved directly to the file server from multiple GOTs, you can view necessary data just by accessing the server.

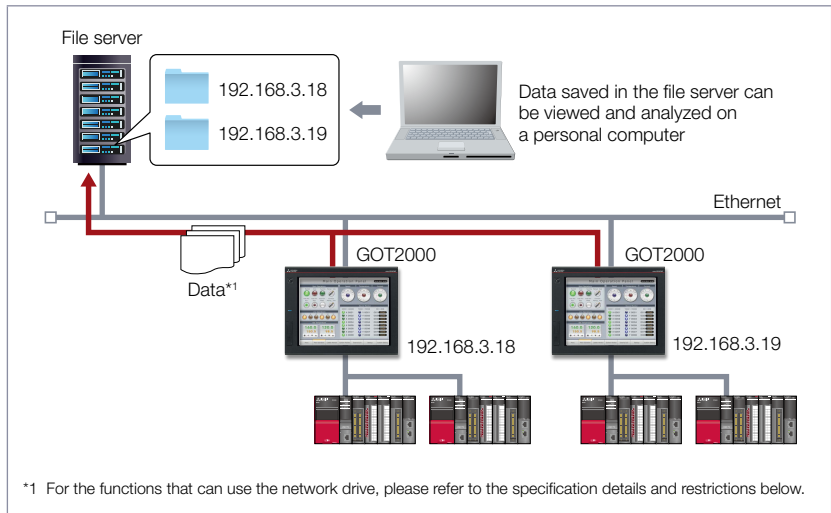

*1 For the functions that can use the network drive, please refer to the specification details and restrictions below.

Specification details and restrictions

- **File server** File servers must support the file sharing function (SMB or CIFS). For recommended file servers, please refer to the relevant product manual.
- **Functions that can use network drive** Document display, logging, hard copy, file printing, report, file transfer function (FTP transfer), file transfer function (GOT internal transfer), file management function
- **Using network drive on multiple GOTs** When the file save destination setting is common to multiple GOTs, select [Separate destinations for each GOT] in the setting dialog for the function using the network drive. A folder named as the GOT's IP address is created automatically and the files can be prevented from being overwritten.

Recommended industries

Automotive	SEMICON, LCD	Electronics
F & B	Pharma	Plant

Supported GOT types

GT27	GT25	GT23
GT21	GS21	SoftGOT

Supported devices

PLC	Servo	Inverter
	Robot	CNC

Printing stored data all at once



■ Printing hard copies and reports

Having problems?



GOT will solve your problems!



How can I make the printer ready and then print data all at once?

Files created in the hard copy function or report function can be printed on a printer. When printing reports, the data can be temporarily stored in an SD memory card or other data storage and printed all at once.

Function features

The hard copy data captured while running GOT or the collected report data can be printed.

Printing reports at an arbitrary timing

The timing to output reports is as follows. Triggers to output data can be set for each report screen.

Supported printer*1*2

- Serial printer
- PictBridge-compatible printer*3
- Ethernet printer*4

*1 For the supported printer models, please refer to the Technical Bulletin No. GOT-A-0064.
 *2 On GT SoftGOT2000, data is output to a printer that is connected to a personal computer.
 *3 Not supported by GT2505, GT25 wide, GT25 handy, GT25 rugged, GT23, GT21, and GS21.
 *4 Supported by GT2104-R and GT2103-PMBD among GT21.

GT27 model, GT25 model, GT23 model

- **When trigger condition is satisfied**
Stores the collected data into a temporary file, and collectively outputs the data to a report when the output trigger condition is satisfied.
- **At the time of data collection** (only when using a serial printer)
Outputs the collected data to a report simultaneously with data collection.
- **Report output destination**
Reports can be output to a file in a data storage or to a printer. By using the file print function, the files saved in a data storage can be previewed on GOT and then printed.

GT21 model, GS21 model

- **At the time of data collection** (only when using a serial printer)
- **When one page's worth of data is collected** (only when using an Ethernet printer)
Output data when one page's worth of data has been collected.

GT SoftGOT2000

- **When trigger condition is satisfied*1**
*1 Data cannot be output to a printer directly. Print images (in CSV format) are stored to the virtual A drive of a personal computer once. Output these images in each file to a printer.

* For the necessary option devices, please refer to the "Function list" (page 166).

Recommended industries

Automotive	SEMICON, LCD	Electronics
F & B	Pharma	Plant

Supported GOT types

GT27	GT25*	GT23*
GT21*	GS21*	SoftGOT*

Supported devices

PLC	Servo	Inverter
	Robot	CNC

* Restrictions apply to some functions. For the details, refer to the function descriptions above.

More information on a single screen



■ Base screen size expansion

Having problems?

I want to check the information on another screen at the same time.

GOT will solve your problems!

Scroll the screen and view other parts of the screen

Can I check all necessary information on one screen without switching screens?

A base screen that is larger than the resolution of GOT can be created and displayed. By displaying the information that used to be separated in multiple base screens, operation can be performed while viewing the whole image.

Function features

A base screen that is larger than the resolution of GOT can be created and displayed. The screen of expanded size can easily be scrolled by using swipe gestures or the scroll bars.

* Supported by GT SoftGOT2000 only when using the SoftGOT-GOT link function.

Example

Displaying an expanded base screen (1600 x 960) on GT27-V (640 x 480)

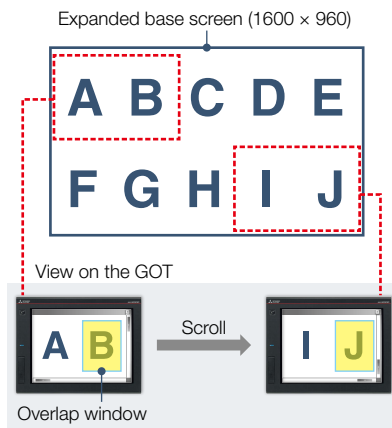

Always display overlap window

Even if the screen is scrolled, the overlap window on the GOT screen is kept displayed in the same position. If there are some objects or information that always need to be displayed on the screen (function keys, etc.), it is possible by using an overlap window.

Operation while viewing the whole image

The navigation window can be displayed on GOT to indicate the current position on the base screen. The window is semi-transparent and displayed in small size to help you view the whole image during operation.

The window display can be changed depending on the setting (always display, do not display, or display while swiping/ touching the screen).

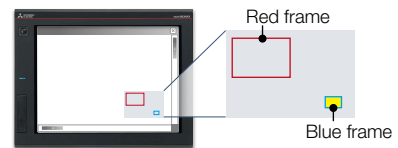

Red frame: Indicates the area currently displayed on the GOT.
Blue frame: Indicates the position of the object where the cursor is located. The frame appears when the cursor moves to any object that is hidden from view. The area enclosed in the frame blinks in yellow.

Specification details and restrictions

- **Graphics setting** GOT Graphic Ver.2 must be selected.
- **Restrictions of other functions** This function cannot be used with the screen gesture function.

Recommended industries

Automotive	SEMICON, LCD	Electronics
F & B	Pharma	Plant

Supported GOT types

GT27	GT25	GT23
GT21	GS21	SoftGOT*

Supported devices

PLC	Servo	Inverter
	Robot	CNC

* Restrictions apply to some functions. For the details, refer to the function descriptions above.

Quickly change comments



Changing comments without using GT Designer3

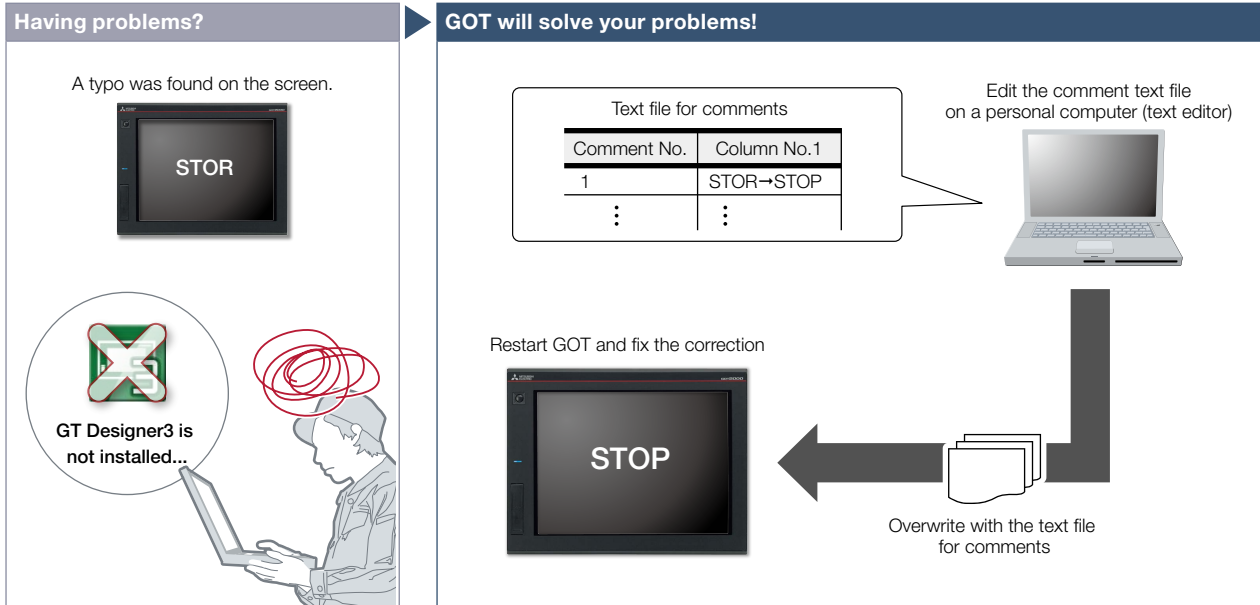

After starting operation, a typo was found on the screen. I need to correct it but there is no personal computer here that has GT Designer3 installed.

Even if GT Designer3 is not installed on the personal computer, comments can be edited and the changes can be reflected to GOT immediately. It helps to apply minor changes to comments without editing the project data.

Function features

The GOT can display comments by reading a comment text file from the installed data storage. After changing a comment, overwrite the comment text file in the data storage and restart the GOT to display the new comment.

* To display comments from a text file, configure the relevant settings in the project data. For the details, please refer to the GT Designer3 (GOT2000) Screen Design Manual.

* USB memory or SD memory card is required.

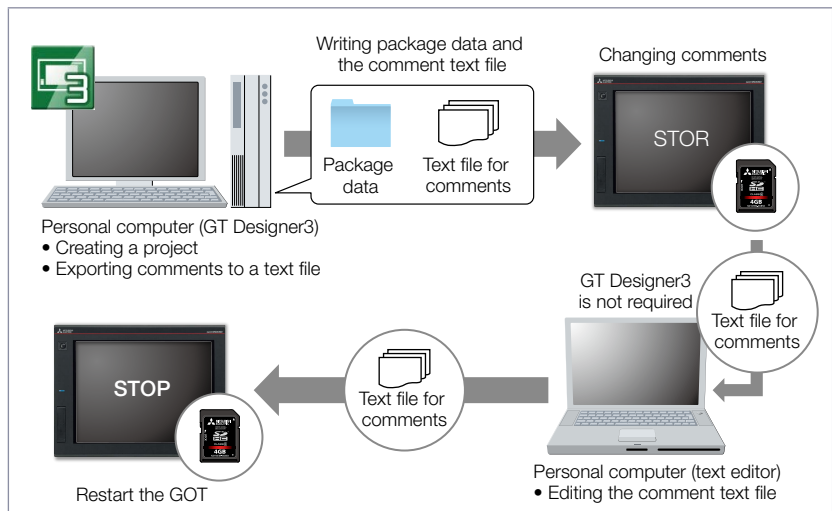

Specification details and restrictions

● **Influence on the GOT startup time** When this function is used, the GOT reads a comment text file at startup, resulting in a longer startup time. To minimize the increase of the startup time, enable this function only for the comment group in which comments may be changed.

● **Font restrictions** Windows® fonts and HQ fonts are not usable to display the comments of a text file. Even if a Windows® font or HQ font is specified in the object setting dialog, the GOT displays the comments in a standard font.

Recommended industries

Automotive	SEMICON, LCD	Electronics
F & B	Pharma	Plant

Supported GOT types

GT27	GT25	GT23
GT21	GS21	SoftGOT

Supported devices

PLC	Servo	Inverter
	Robot	CNC

Support FDA 21 CFR Part 11



Regarding FDA 21 CFR Part 11 support



How can I support FDA 21 CFR Part 11 easily?



GOT can be used to make your system meet the requirements of FDA 21 CFR Part 11.

* The users must construct an appropriate system for the compliance with the FDA 21 CFR Part 11. For the details, please refer to the Technical Bulletin No. GOT-A-0077.

Function features

GOT can be used to support FDA 21 CFR Part 11, the standards about electronic data recording of the traceability information, which is required in the food and pharmaceutical industries. Sample screens are available for helping you configure systems.

GOT functions related to FDA 21 CFR Part 11

- (1) **Managing users who access the GOT**
Operator authentication and security level setting
- (2) **Managing screen data**
User management, access control
- (3) **Completeness of data**
Network drive, FTP client, FTP server
- (4) **Security and viewing of data**
Operation log, alarm, logging, recipe
- (5) **Audit trail**
Operation log
- (6) **Validation of data and operations**
Verification (GT Designer3 function)
- (7) **System development, operation, and management**
Security level setting

Access management per operator

The operator authentication function enables management of users who can login to GOT. (For details, see page 97.)

* To prevent impersonations, user accounts should be managed thoroughly by the users.

Operator authentication screen

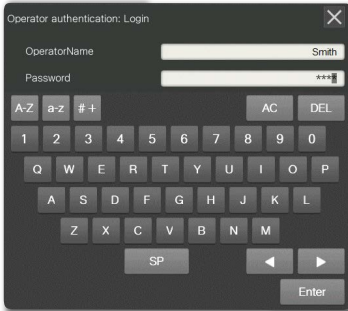

Input an operator name and password for login

Recording audit trails (histories for the follow-up survey later)

Audit trails can be recorded and operated by setting the operation log appropriately. (For details, see page 96.)

- <Information required to be recorded>
- Time stamp
 - User name of the logged-in operator
 - Description and details of the operation performed by the operator (logs before and after the data change)

Operation log list

Operator names stored in programmable controller devices can be used, thus enabling interaction with user management systems.

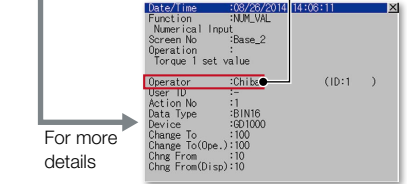

For more details

Specification details and restrictions

- **Range of supporting FDA 21 CFR Part 11** The range that GOT can support the regulation is limited. For the details, please refer to the Technical Bulletin No. GOT-A-0077 on the Mitsubishi Electric Factory Automation Global website (www.MitsubishiElectric.com/fa/).
- **How to obtain sample screens** Sample screens are included in GT Works3. For the details, please contact your local sales office. The sample screens are supported by the following GT Works3 versions: Ver.1.152J or later.

Recommended industries

- F & B
- Pharma

Supported GOT types

- GT27
- GT25
- GT23
- GT21
- GS21
- SoftGOT

Prevent data alteration with security settings for PDF files

NEW

GT Reporting Tool

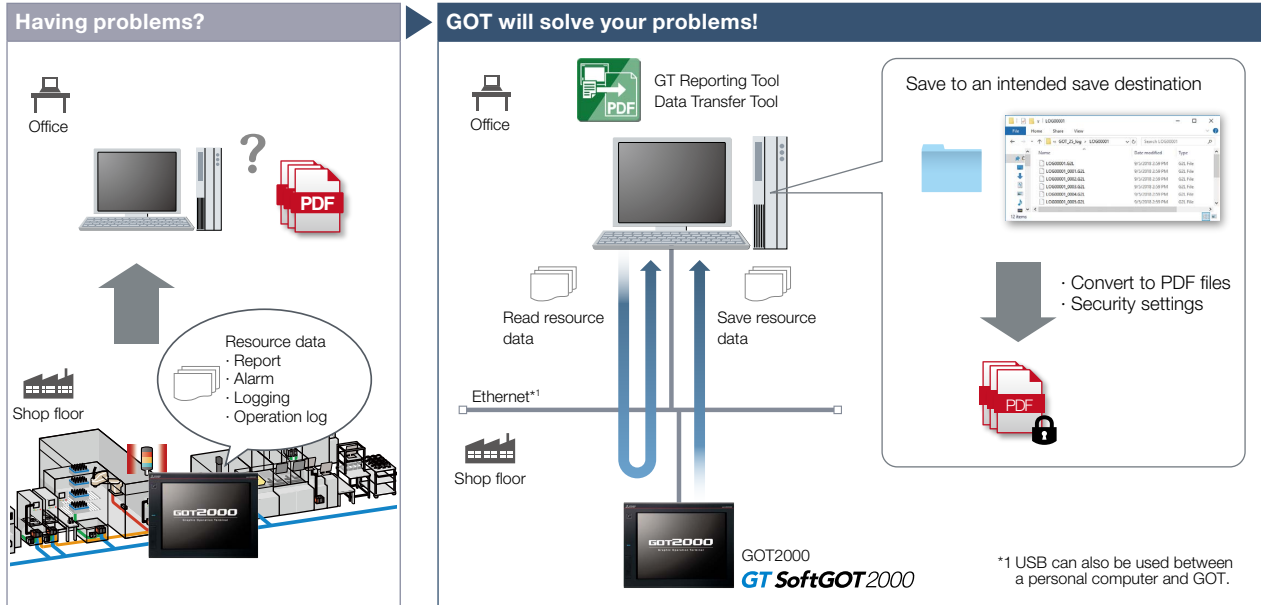

Can we check the GOT resource data on a personal computer? We need to consider how to prevent data alteration.

By using GT Reporting Tool on a personal computer, the resource data created with GOT2000 or GT SoftGOT2000*1 can be converted to PDF files. Unauthorized use can be prevented by setting security for PDF files.

*1 Restrictions apply to some functions. For the details, please refer to the specification details and restrictions at the bottom of the page.

Function features

Some functions of GT Reporting Tool can be executed with a command line. It is useful for converting multiple files at once because the tool has various functions such as setting a logo and setting a PDF password and digital signature.

Automatic file conversion

The resource data can be converted to PDF files automatically. Files can be automatically converted by setting the network drive*2 as the destination to save the GOT resource data and then setting the network drive as the file server for GT Reporting Tool to access.

*2 For the details, please refer to page 98.

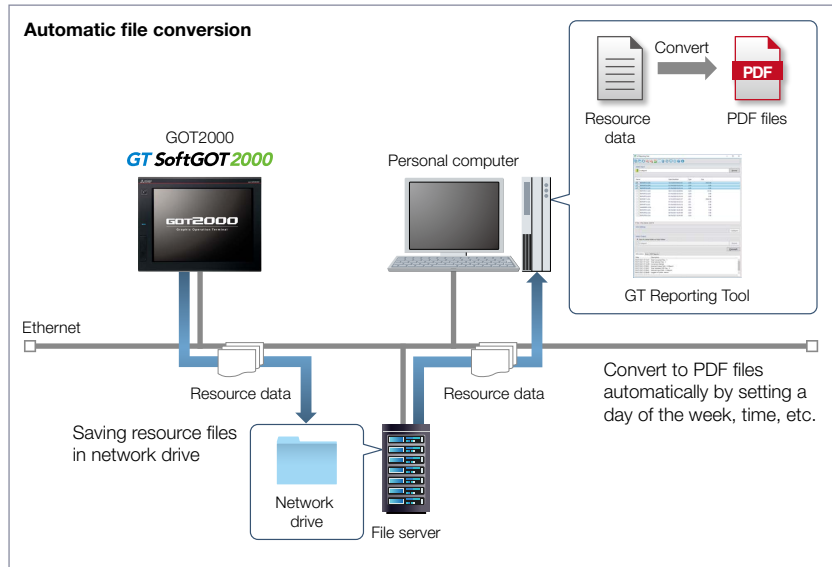

Specification details and restrictions

● **Resource data that can be converted to PDF files** Report file (*.G2R)*1, alarm file (*.G2A)*1, logging file (*.G2L), operation log file (*.G2O)

*1 GT SoftGOT2000 does not support outputting files of this format.

● **Operation with a command line and executable functions** For the details, please refer to the Help for GT Reporting Tool. When installing GT Reporting Tool, the Help for the tool is also stored in the installation folder. Before starting operation with a command line, it is required to install the latest version of Data Transfer Tool.

Recommended industries

Automotive	SEMICON, LCD	Electronics
F & B	Pharma	Plant

Supported GOT types

GT27	GT25	GT23
GT21	GS21	SoftGOT*

Supported devices

PLC	Servo	Inverter
	Robot	CNC

* Restrictions apply to some functions. For the details, refer to the specification details and restrictions above.

Easy data collection



Logging & Graph/List

4

GOT Solutions - Security & Additional System Features

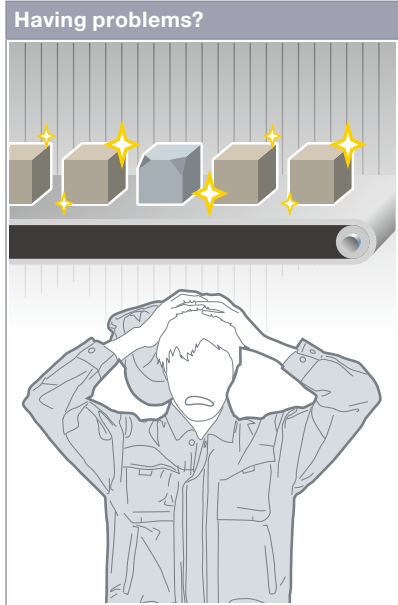

Defective product... I need to quickly identify the cause of errors.

GOT will solve your problems!

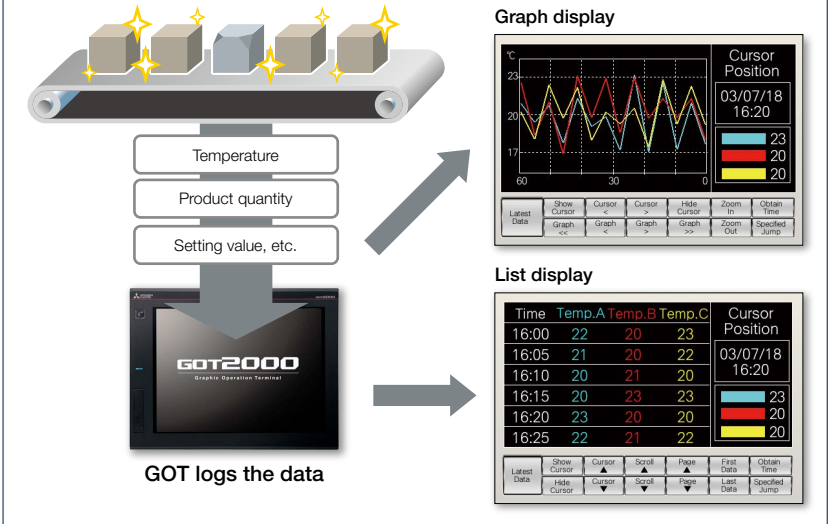

Function features

GOT collects the data from programmable controllers and temperature controllers and displays the collected data in a graph and list. The logging data can be saved in a built-in SRAM* even when the power supply has failed.

* Not supported by GT21, GS21, and GT SoftGOT2000.

Analyze data on personal computer

The logging data can be converted into a CSV file or Unicode® text file and saved to an SD memory card or USB memory so that the data can be displayed on a personal computer.

Historical trend graph

The data collected by the logging function is displayed in a graph in chronological order. Scrolling the graph and specifying the time make it easier to check the necessary data.

Historical data list

The data collected by the logging function is displayed in a list. Specifying the time in the list displays the historical trend graph of the specified time.

Supporting network drive

The network drive can be used as the save destination for logging files. Data can be saved without considering the capacity limit.

* Not supported by GT23, GT21, and GS21.

* For the details, please refer to page 98.

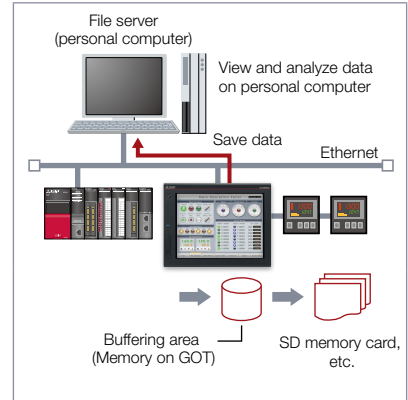

Specification details and restrictions

● Supported device formats Bit, BIN, BCD, Real, String

* For the necessary option devices, please refer to the "Function list" (page 166).

Recommended industries

Automotive	SEMICON, LCD	Electronics
F & B	Pharma	Plant

Supported GOT types

GT27	GT25	GT23*
GT21*	GS21*	SoftGOT*

Supported devices

PLC	Servo	Inverter
	Robot	CNC

* Restrictions apply to some functions. For the details, refer to the function descriptions above.

Simple touch operations



Gesture function

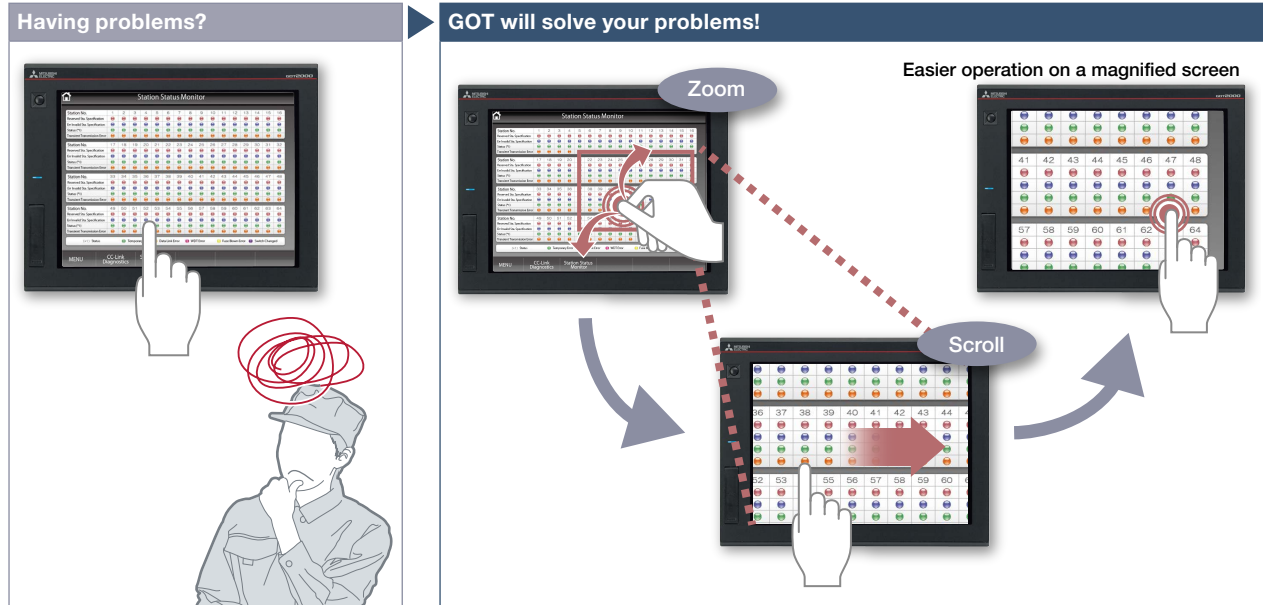

It's hard to touch small parts on the screen!

Zoom in to easily operate small and hard to reach switches. After zooming in, scroll the display to show the area you want to operate.

Function features

In addition to touch operations, gesture operations are now available on the GOT in the same way as on tablet or mobile terminals.

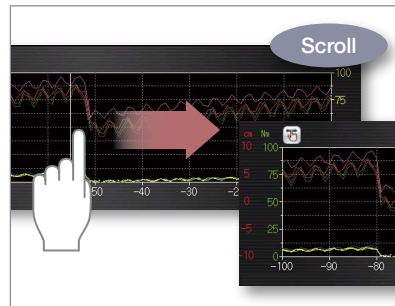

Object gesture

Specify an object to be enlarged, scrolled or flicked.



2-point press operation

To prevent accidental operations, press 2 points simultaneously and enable the touch operation.

Specification details and restrictions

● **Objects applicable to the object gesture function** Historical data list display, alarm display (user), alarm display (system), simple alarm display, historical trend graph, document display, video/RGB display object*1

*1 Not supported by GT2705.

Recommended industries

Automotive	SEMICON, LCD	Electronics
F & B	Pharma	Plant

Supported GOT types

GT27*	GT25	GT23
GT21	GS21	SoftGOT

Supported devices

PLC	Servo	Inverter
Robot	CNC	

* Restrictions apply to some functions. For the details, refer to the function descriptions above.

Easy interaction with database



MES interface function

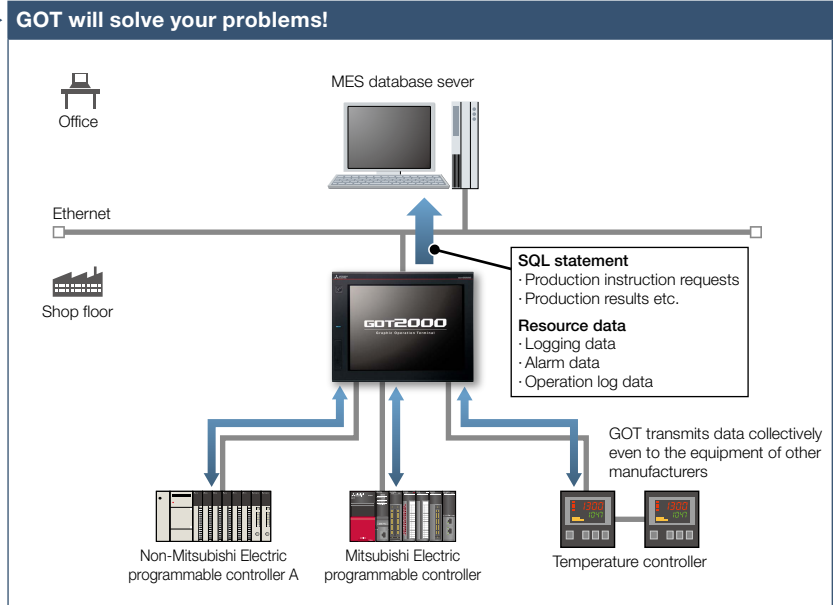
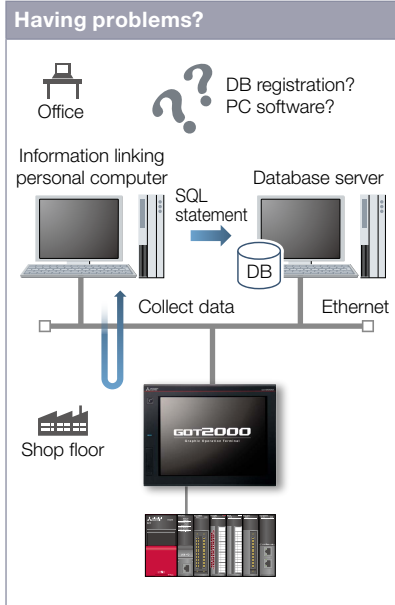

How can I analyze the shop floor information and increase production efficiency? Does it take time to construct the system?

Function features

The GOT uses SQL statements*1 to transmit data from the connected industrial devices to a database server.*2

*1 Communication actions can be selected from SELECT, Multi-SELECT, UPDATE, INSERT, or DELETE.

*2 A separate license (GT25-MESIFKEY) is required.

Easy communication without programming

Communication with databases is configured in GT Works3 without any programming.

GOT communicates with the MES database server without a personal computer and programs and sends the data such as production instruction requests and production results. Storing the resource data such as alarm history and logging data to a database enhances traceability.

Transferring data of various devices collectively

GOT transmits data collectively to an MES database server by collecting data from various devices of different types and manufacturers. Collecting data in the GOT makes it easy to transmit data to the database.

Unicode® support for tag data type

Unicode® character strings can be used as the data type of collected data (device data). Multiple languages including Chinese are supported and there is no need to worry about character codes.

Resource data send function

The resource data collected in the GOT buffering area or an SD memory card can be sent to a database. The alarm information of GOT can be stored and managed in the database.



<MES (Manufacturing Execution System)>
The manufacturing execution system (MES) is a system that controls and manages production processes at a shop floor in order to optimize quality, productivity, delivery date, and cost.

Specification details and restrictions

* For the necessary option devices, please refer to the "Function list" (page 166).

- **Function list** ·DB interface function (resource data send function / tag function / trigger buffering function / trigger monitoring function / SQL text transmission function / arithmetic processing function / program execution function / DB buffering function) ·Diagnosis function ·DB server function (ODBC connection function / connection setting function / log output function)
- **Usable databases** Please refer to the GOT2000 Series MES Interface Function Manual.

Recommended industries

Automotive	SEMICON, LCD	Electronics
F & B	Pharma	Plant

Supported GOT types

GT27	GT25	GT23
GT21	GS21	SoftGOT

Supported devices

PLC	Servo	Inverter
	Robot	CNC

Support management of on-site data



File manager function

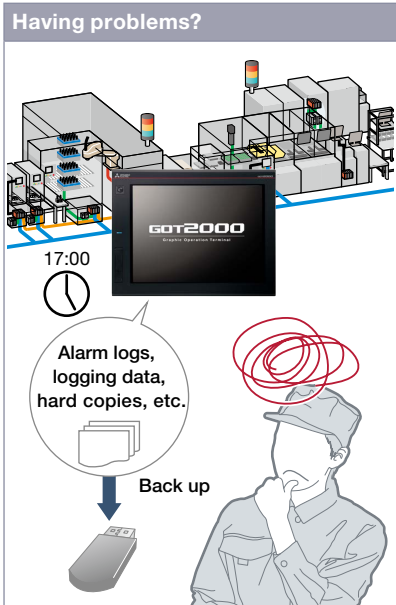

How can I make backup of alarm and logging data? It's bothersome to back up data separately.

Function features

Check the folders and files that are stored on the GOT's SD memory card or USB memory, and copy or delete them in the list.

Graphical list display

File types can be identified with icons at a glance.

Supporting network drive

Since the GOT files can be directly copied or moved to the network drive, data can be backed up easily.

* Supported by GT27, GT25.
* For the details, please refer to page 98.

GOT will solve your problems!

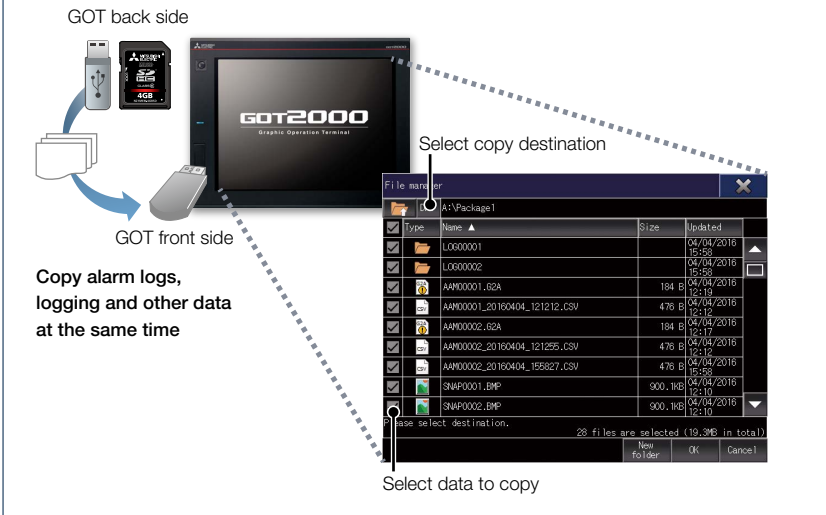

Folders and files are shown in a list on a graphical screen so that it is easy to copy them as needed.

Various file operations

Copy, delete, move, rename, or create files and folders. Multiple selection of files and folders is also possible. Files can be operated also in mobile screens using the GOT Mobile function.

Checking available space in drives

Easily check available space in the drives. It is useful when saving cumulative data such as logging and hard copies.

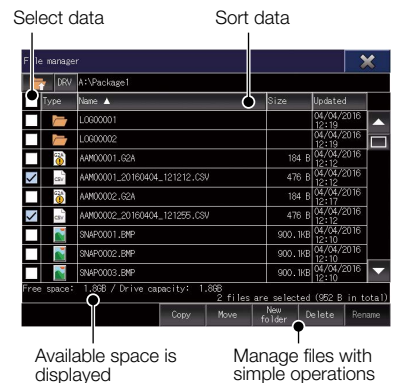

Recommended industries



Supported GOT types



* Restrictions apply to some functions. For the details, refer to the function descriptions above.

Supported devices



* For the necessary option devices, please refer to the "Function list" (page 166)

Send and retrieve files between GOT and PC



File transfer function

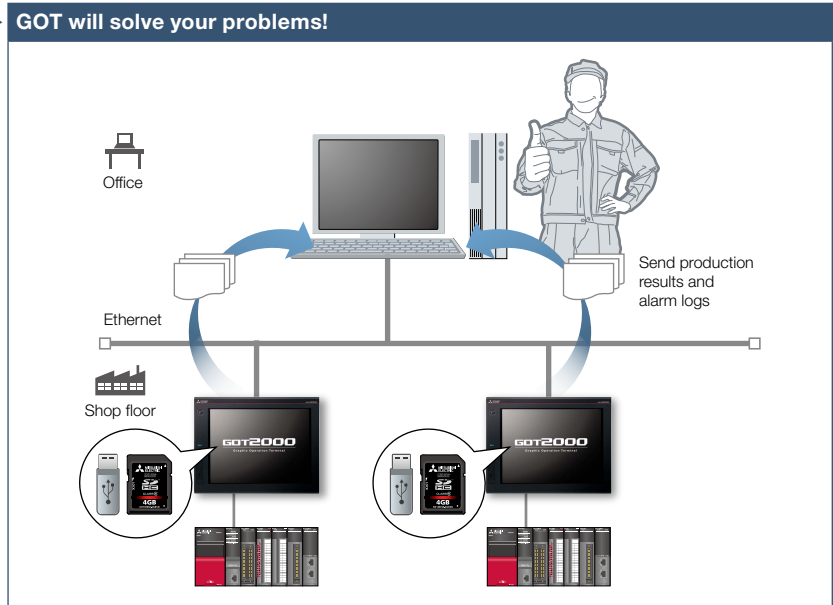

How can I check daily production results?

By using GOT, production results can be stored on the GOT's SD memory card or USB memory and sent to a personal computer or the USB memory on the front face of GOT. The GOT can also receive production instructions from the personal computer.

Function features

Files stored on the GOT's SD memory card or USB memory can be transferred easily. Network drive can be used as the transfer destination.

FTP transfer

By using GOT, files stored on the GOT's SD memory card or USB memory can be sent to or received from an FTP server (personal computer). File transfer triggers (sampling, bit rise, etc.) can be used to set file transfer timing.

* Supported by GT2107-W, GT2104-R, and GT2103-PMBD among GT21 models.

GOT internal transfer

Files stored on the SD memory card or USB memory connected to the back side of GOT can be transferred to the USB memory on the front face of the GOT so that data can be obtained easily.

* Not supported by GT21 and GS21.

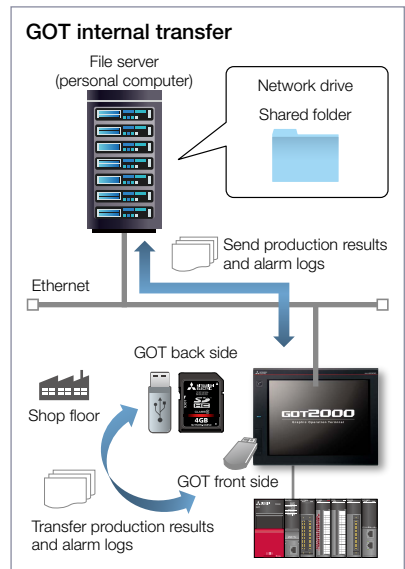
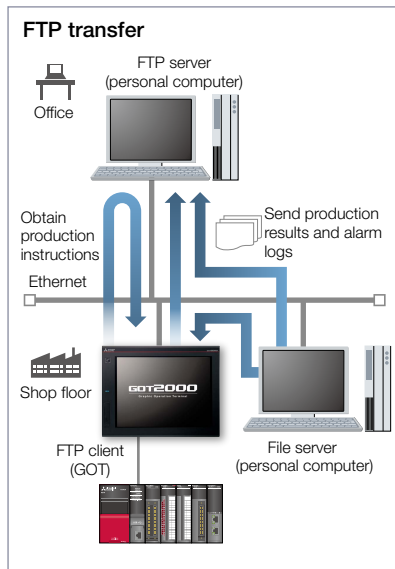

File transfer using a network drive

The GOT data stored in a file server (personal computer) connected by Ethernet can be transferred to an FTP server (personal computer), or the data can be directly transferred between the GOT and the file server (personal computer).

* Not supported by GT23, GT21, and GS21. For the details, see page 98.

Specification details and restrictions

* For the necessary option devices, please refer to the "Function list" (page 166)

● **Validated FTP servers and clients** Please refer to the Technical Bulletin No. GOT-A-0167 on the Mitsubishi Electric Factory Automation Global website (www.MitsubishiElectric.com/fa/).

Recommended industries

Automotive	SEMICON, LCD	Electronics
F & B	Pharma	Plant

Supported GOT types

GT27	GT25	GT23*
GT21*	GS21*	SoftGOT

Supported devices

PLC	Servo	Inverter
	Robot	CNC

* Excluding some models or restrictions apply to some functions. For the details, refer to the function descriptions above.

Various controllers and connection types



Multi-channel function/Device data transfer function

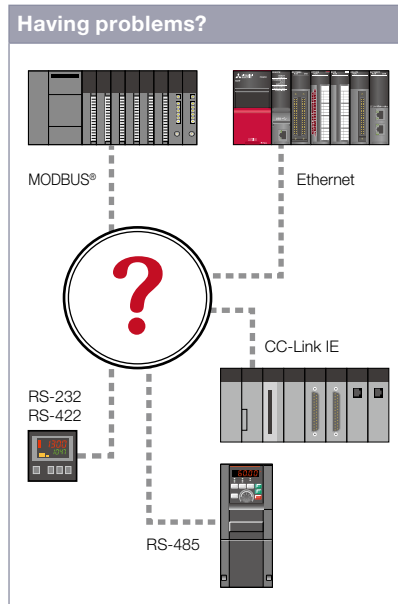

How can I connect various industrial devices in various connection types?

Function features

GOT supports various industrial devices and connection types. With the multi-channel function and the device data transfer function, multiple types of industrial devices of different manufacturers can be monitored.

* Excluding GT2103-PMBLS

<Supported connection types>

Ethernet, RS-232, RS-422/485, CC-Link IE TSN, CC-Link IE Controller Network, CC-Link IE Field Network, CC-Link, Bus, MELSECNET/H*, MODBUS®

* Including MELSECNET/10 mode.

Multi-channel function

Up to four channels* of industrial devices (programmable controller, servo, inverter, temperature controller, etc.) can be monitored with one GOT.

* Up to 2 channels on GT23, GT21, and GS21.

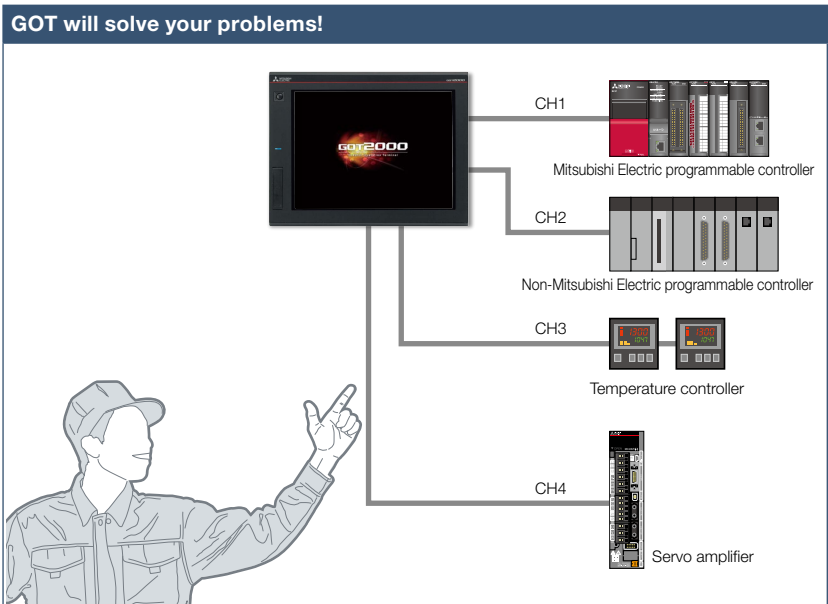

GOT supports various industrial devices and connection types. With the multi-channel function, four channels of industrial devices can be monitored on a single GOT.

<Typical applications>

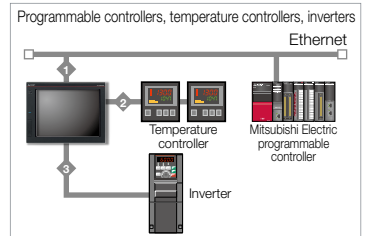
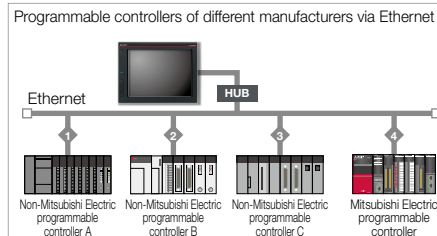

Device data transfer function

Using GT Works3, simply set source devices, destination devices, and triggers and you can transfer devices between industrial devices.

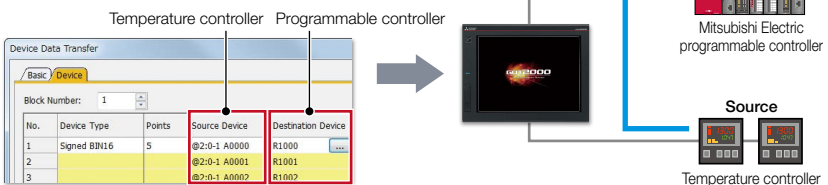

Device Data Transfer		Temperature controller	Programmable controller
Basic Device			
Block Number: 1			
No.	Device Type	Points	Source Device
1	Signed BIN16	5	@2:0-1 A0000
2			@2:0-1 A0001
3			@2:n-1 A00n2
			Destination Device
			R1000
			R1001
			R1002

Specification details and restrictions

- **Various peripherals** External devices (operation panels, switches, lamps, etc.), two-dimensional code readers, barcode readers, RFID readers, IC card readers, speakers, video cameras, displays (RGB output), personal computers (RGB input), serial printers, PictBridge compatible printers
- **Multi-channel function** Supported connection types, channel numbers, and functions vary depending on the GOT type. For the details, please refer to the relevant product manual or the "Connectable model list" (page 170).

Recommended industries

Automotive	SEMICON, LCD	Electronics
F & B	Pharma	Plant

Supported GOT types

GT27	GT25	GT23*
GT21*	GS21*	SoftGOT

Supported devices

PLC	Servo	Inverter
	Robot	CNC

* Excluding some models or restrictions apply to some functions. For the details, refer to the function descriptions above.

Support CNC maintenance



Interaction function with CNCs

4

GOT Solutions - Interactive Features with Other Industrial Devices



Having problems?

GOT will solve your problems!



Alarm screen (CNC monitor 2)

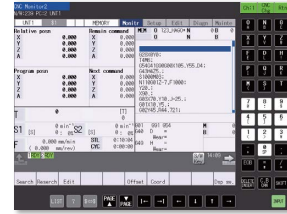

Monitor screen (CNC monitor 2)

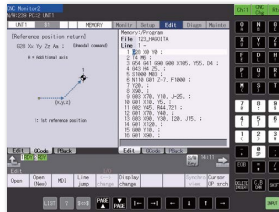

Edit screen (CNC monitor 2)



Input/Output screen (CNC monitor 2)

“NC alarm” occurred on a GOT!
How can I maintain the system quickly?

Function features

A GOT can be used to display various monitors and make settings of a CNC connected to the GOT.

CNC monitor 2 function (CNC C80)*1

The function enables monitoring and operation of the standard screens (monitor, setup, edit, diagnosis, and maintenance) of the C80 Series CNC connected to the GOT. You can also use this function to input/output data or edit machining program of the CNC C80.

Use a GOT to monitor or check alarms of a CNC. When an NC alarm occurs, there's no need to use a personal computer when modifying programs and you can quickly recover the system.

CNC monitor function (CNC C70)*2*3

The function enables the alarm diagnosis, position display monitor, tool compensation/parameter setting, or program monitor of a CNC C70 connected to the GOT.

CNC machining program edit function (CNC C70)*2*3

Machining programs and MDI programs of a CNC C70 connected with the GOT can be edited.

CNC data I/O function (CNC C70)*2*3

Machining programs and parameters can be copied, compared, or deleted in a CNC C70 connected with the GOT.

CNC data input/output function

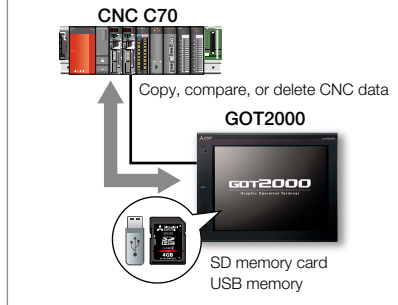

- *1 Not supported by GT25 wide and GT25 rugged models.
- *2 Supported by GOTs with a resolution of SVGA or higher.
- *3 Not supported by GT25 wide, GT25 rugged, and GT25 handy models.

Specification details and restrictions

* For the necessary option devices, please refer to the “Function list” (page 166).

● **Target models** CNC (C80, C70)

● **Supported connection types** Ethernet connection (DISPLAY I/F connection only)*1, bus connection*2

*1 The CNC monitor, the CNC machining program edit function, and the CNC data I/O function cannot be used with CNC C70 when CC-Link IE Field Network Ethernet adapter module is used.

*2 Supported by CNC C70 only.

● **Target data**

CNC monitor 2 function The target data is the same as that of the CNC monitor function, the CNC machining program edit function, and the CNC data I/O function.

CNC monitor function Alarm diagnosis, position display, tool compensation parameter setting, program, APLC release screen

CNC machining program edit function Machining program, MDI program

CNC data I/O function Machining program, parameter, tool offset data, workpiece offset data, common variable, maintenance data, cycle monitor data

Recommended industries

Automotive Electronics

Supported GOT types

GT27* GT25* GT23
GT21 GS21 SoftGOT

Supported devices

PLC Servo Inverter
Robot CNC

* Excluding some models. For the details, refer to the function descriptions above.

Support visualization of a large scale system

NEW

■ GENESIS64™ interaction function (Gateway function)

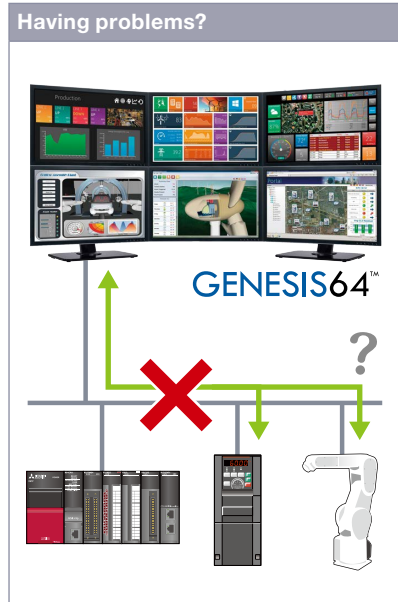

Can we collect and manage the information of industrial devices by accessing them from SCADA without using an OPC server?

Function features

The GENESIS64™ SCADA software can collect the data of connected devices via gateway devices of GOT2000 or GT SoftGOT2000 that acts as a gateway server.

After establishing correlation between GENESIS64™ tags*1 and GOT2000 gateway devices, the users can make settings with familiar tags on SCADA without worrying about actual device names.

*1 The "tags" are data used when GENESIS64™ accesses external data.



For the details, please refer to the ICONICS Automation Software Suite catalog (L(NA)08785ENG).

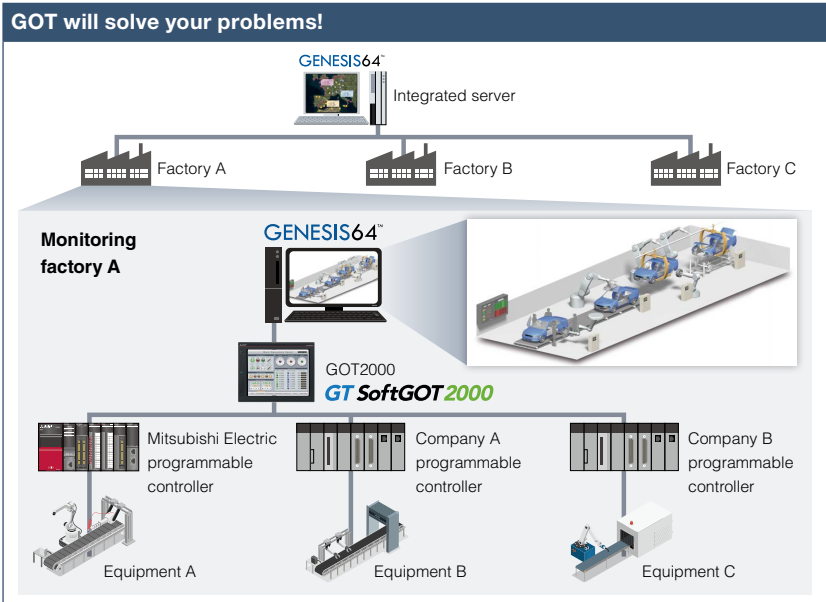

The GENESIS64™ SCADA software can collect the information of devices on each equipment via GOT2000 or GT SoftGOT2000 that is installed on the shop floor. This is useful not only for monitoring the operation status of equipment in each factory, but also for advanced preventive maintenance and predictive maintenance.

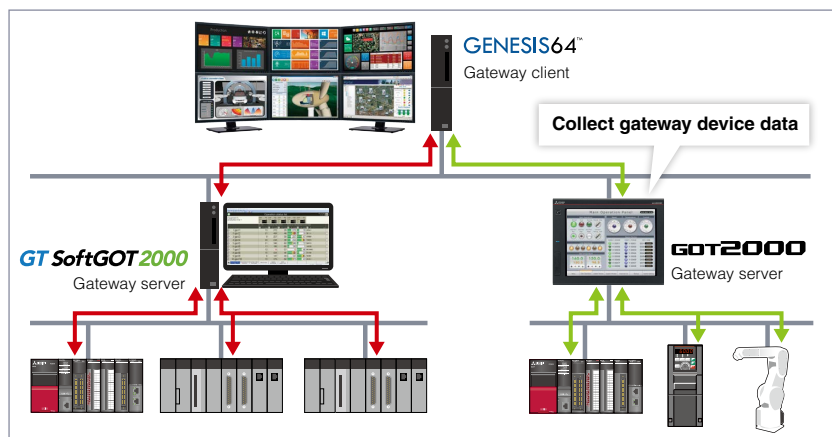

Easy connection without OPC server

OPC servers are not required when GENESIS64™ reads and writes data of devices connected to GOT2000 using GOT gateway devices.

Specification details and restrictions

- **Applicable SCADA software** GENESIS64™ Version10.97.1 or later
- **Applicable GT Designer3** Version1.265B or later
- **Number of GOT2000 (servers) simultaneously accessible to a personal computer (GENESIS64™)** 16 maximum
- **Number of automatically detectable units and modules** 255 maximum (the total of GOT2000 and GT SoftGOT2000*1 modules)

*1 For GT SoftGOT2000, the number of running modules is the maximum number of automatically detectable modules.

● **Devices that can be monitored and accessible range from GENESIS64™** For the details, please refer to the GT Designer3 (GOT2000) Screen Design Manual.

Recommended industries

Automotive	SEMICON, LCD	Electronics
F & B	Pharma	Plant

Supported GOT types

GT27	GT25	GT23
GT21	GS21	SoftGOT

Supported devices

PLC	Servo	Inverter
	Robot	CNC

Support iQSS-compatible devices



Upgraded

iQSS utility function

4

GOT Solutions - Interactive Features with Other Industrial Devices

Having problems?

iQSS-compatible devices such as AnyWireASLINK

GOT will solve your problems!

GOT2000

Check if AnyWireASLINK sensors are disconnected and quickly take corrective actions as needed.

Connect an SD memory card or USB memory that stores the iQSS-compatible device information to the GOT

iQSS-compatible devices such as AnyWireASLINK

How can I check the status of AnyWireASLINK without a personal computer?

Check the status of iQSS-compatible devices such as AnyWireASLINK and the parameter information on the GOT without a personal computer.

Function features

Just enable the iQSS utility function to automatically generate monitoring screens. There is no need to create monitoring screens for every sensor and thus you can reduce time for startup, operation, and maintenance of the sensor system.

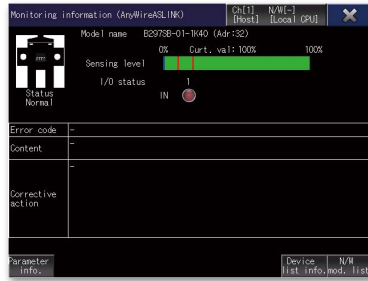

Monitoring information screen

The status, sensing level, I/O status of the device being monitored can be checked in this screen.

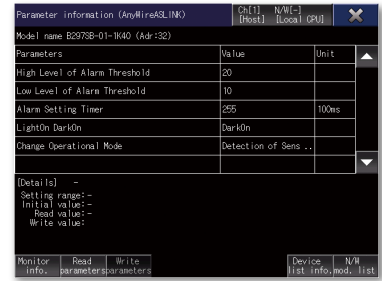

Parameter information screen

The list of parameters and the details of the device being monitored can be displayed. Parameters can be changed in this screen.

For the details, please refer to the iQ Sensor Solution catalog (L(NA)16029ENG).



Specification details and restrictions

* For the necessary option devices, please refer to the "Function list" (page 166).

- **Target models** RCPU: AnyWireASLINK Ver.1.0 and AnyWireASLINK Ver.1.1**2 are supported
QCPU (Q mode), LCPU: AnyWireASLINK Ver.1.0 is supported

*1 Devices whose first two digits of the manufacturing information are 03 or later are supported.

*2 When using word data, use devices which support AnyWireASLINK Ver.1.1 for both master and slave modules.

- **Supported connection types**1** Ethernet connection*2, direct CPU connection (serial)*3, serial communication connection, CC-Link IE Controller Network connection*4, CC-Link IE Field Network connection*4, CC-Link connection, bus connection*5, MELSECNET connection*5, MELSECNET/10 connection*5*6

*1 For the details of connectable models of each connection type, please refer to the "Connectable model list" (page 170).

*2 L02SCPU or L02SCPU-P cannot be used.

*3 When connecting the GOT with the LCPU, use L6ADP-R2.

*4 Cannot be used to connect a Q00JCPU, Q00CPU, Q01CPU, Q02CPU, Q02HCPU, Q06HCPU, Q12HCPU or Q25HCPU.

*5 RCPU and LCPU are not supported.

*6 Use a QCPU and network module (QJ71LP21, QJ71LP21-25, QJ71LP21S-25, QJ71LP21G, and QJ71BR11) with the function version B or later.

Recommended industries

Automotive	SEMICON, LCD	Electronics
F & B	Pharma	Plant

Supported GOT types

GT27	GT25	GT23
GT21	GS21	SoftGOT

Supported devices

PLC	Servo	Inverter
	Robot	CNC

Easy IoT application to the equipment

Upgraded

■ e-F@ctory Starter Package (free of charge sample project)



Support maintenance work



Support system startup/adjustment



Support system operation

Having problems?

How can I use the collected data?

What should we do to add IoT functions?

To add IoT functions to the shop floor, what do we have to do in the first place?

Function features

The e-F@ctory starter package includes sample projects for the MELSEC iQ-R/iQ-F Series programmable controller and the GOT2000 Series human-machine interface.

Programs for visualization and simple analysis are provided in sample project format, realizing IoT infrastructure on the shop floor just with basic settings such as device assignment and parameter registration.



For the details, please refer to the e-F@ctory Starter Package leaflet (E001ENG).

GOT will solve your problems!

Sample project

MELSEC iQ-F Series MELSEC iQ-R Series GOT2000 Graphic Operation Terminal

Clear graphic display of analysis results

Simple analysis from collected equipment information

Remote monitoring with GT SoftGOT2000

GT SoftGOT2000

By adding the integrated management programmable controller and GOT to the existing equipment, "visualization", "simple analysis", and other functions can be easily developed by using the simple CPU communication function.

Low-cost installation

Installation cost can be reduced because it is not necessary to create sequence program and screen data from scratch. A large lineup of functions that focus on management, maintenance, and improvement of equipment are available.

Management function screen

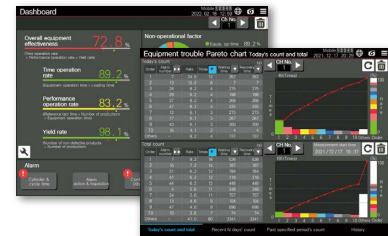

MT method screen



Vibration analysis screen

Improvement function screen



* Screen images are subject to change without notice.

Specification details and restrictions

- **Target models** MELSEC iQ-R Series, MELSEC iQ-F Series*, GOT2000 Series, GT SoftGOT2000 *1 Some functions are not supported.
 - **Lineup of project data** MELSEC iQ-R/iQ-F Series project data, GOT2000 Series SVGA (800 × 600) project data (By changing the GOT type, data can be used for other models.)
 - **Lineup of provided functions** MELSEC iQ-R Series (Equipment operation monitoring solution (dashboard, production counting, process capability index (histogram), operational status monitor, cylinder & cycle time measurement monitor, error corrective actions and inspections, sensor value monitor, equipment trouble Pareto chart, control chart (Xbar-R/S), loss time analysis, specific energy consumption management, output as spreadsheet), MT method simple diagnosis solution (MT method, vibration analysis, time series data collection), vibration analysis, waveform guard band monitoring, equipment inspection, change point monitoring log)
- MELSEC iQ-F Series (overall equipment effectiveness monitor, cylinder and cycle time measurement monitor, MT method, equipment trouble Pareto chart)

Recommended industries

Automotive	SEMICON, LCD	Electronics
F & B	Pharma	Plant

Supported GOT types

GT27	GT25	GT23
GT21	GS21	SoftGOT

Supported devices

PLC	Servo	Inverter
	Robot	CNC

Support screen design



Standard screen samples



GOT will solve your problems!

Trend graph display (7 patterns)
Displays the data collected with the logging function in a trend graph

Counter display (4 patterns)
Monitors or resets counters for the data such as production volume and tool use

Now we have HMIs but it's hard to design screens from scratch.

Standard screens are grouped into 17 categories by purpose. Frequently used screens are available as sample screens.

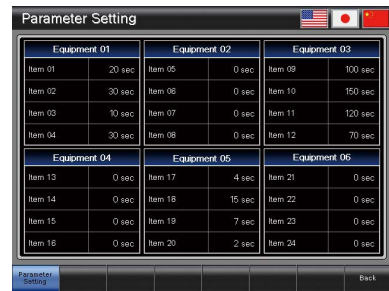

Parameter setting (3 patterns)
Displays set items and enables input of set values for various parameters



Manual operation (6 patterns)
Executes ON/OFF operations of signals (bit devices)

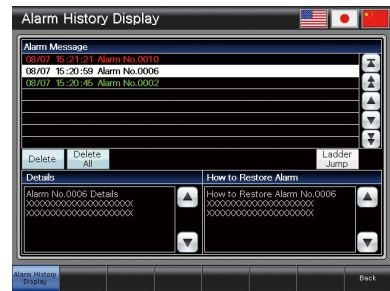

Alarm history (2 patterns)
Displays alarms in the history format and enables checking of the details and recovery methods of a selected alarm

Function samples

These are sample screens that you can feel GOT2000 recommended functions.

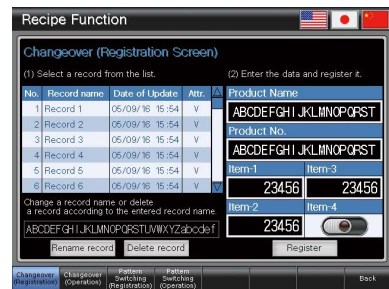

Recipe
Provides samples to use the recipe function easily

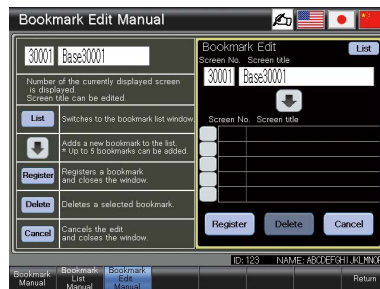

Screen bookmark
Provides the list to bookmark screens. You can register frequently-used screens and switch between the screens in the list.

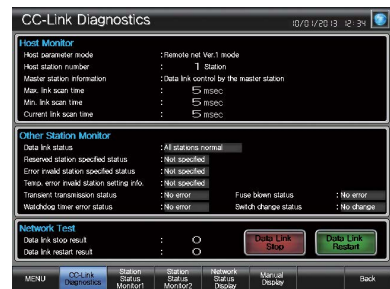

CC-Link network monitor
Displays the CC-Link network status (host station, other stations, errors, etc.)

Specification details and restrictions

- **Other standard screen samples** I/O signal display, numerical data display, start-up condition display, operation ready signal display, interlock display, interlock setting, machine selection setting, alarm frequency display, alarm status display, current alarm display, home position return, cycle time display
- **Other function samples** GOT Mobile function (Andon, remote controller), alarm function (level, sort), alarm function (hierarchy), device monitor function, Kana-Kanji conversion function, AnyWireASLINK network monitor function, how to comply with FDA 21 CFR Part 11, PDF search external control function, etc.
- **How to obtain sample screens** Sample screens are included in GT Works3. For the details, please contact your local sales office.
- **Supported language** English, Japanese, Chinese (Simplified)

Support connection with industrial devices



■ Connection samples

The lineup of samples for non-Mitsubishi industrial devices has been expanded! These are sample screens for monitoring current values of connected devices, setting parameters, etc.

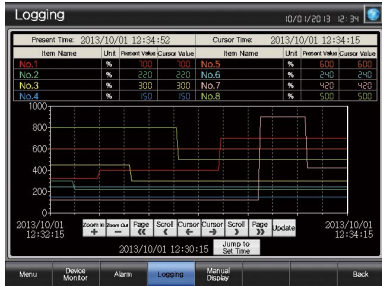

Mitsubishi Electric programmable controller

- MELSEC iQ-R Series R08CPU
- MELSEC iQ-F Series FX5U-32MCPU
- MELSEC-L Series L06CPU
- MELSEC-Q Series Q06UDEHCPU
- MELSEC-F Series FX3U-16MCPU

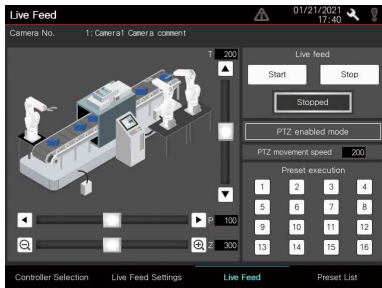

Mitsubishi Electric camera recorder module

- MELSEC iQ-R Series RD81RC96-CA **NEW**

■ iQSS related samples

These are sample screens to connect to iQSS-compatible devices.



AnyWireASLINK master module
iQSS utility linkage
network monitor function **NEW**

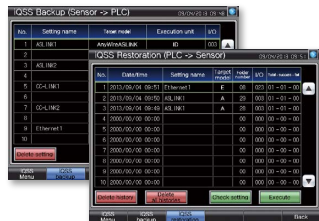

iQSS backup/restoration
(PLC->sensor) function

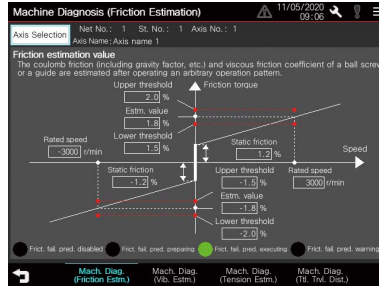

Mitsubishi Electric servo amplifier **GOT Drive**

For the target models, please refer to the GOT2000 Drive Control (Servo) Interactive Solutions catalog (L(NA)08335ENG).

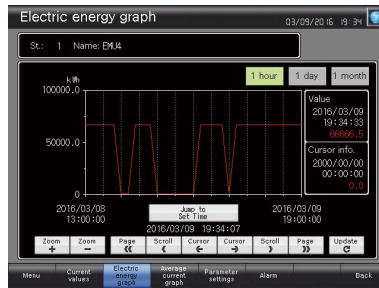

Mitsubishi Electric other devices

- Motion controller
- Simple Motion module
- Industrial robot **GOT Drive**
- Energy measuring unit EcoMonitorLight/ Electric multi-measuring instrument etc.

■ Using sample screens

In the GT Works3 menu, select [Screen] → [Utilize Data].

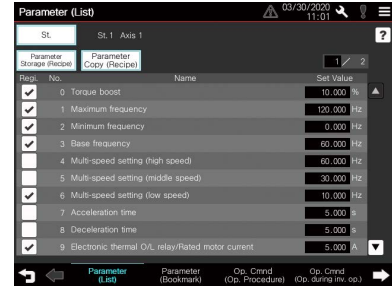
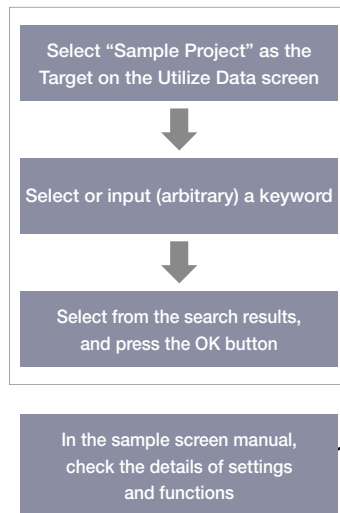

Mitsubishi Electric inverter **GOT Drive**

For the target models, please refer to the "GOT Drive Control (Inverter) Interactive Solutions" (page 69).

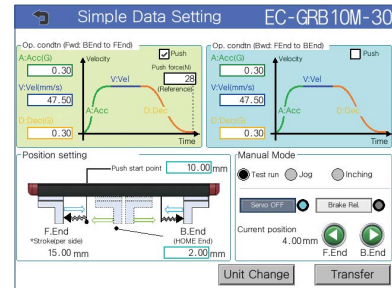

Non-Mitsubishi Electric industrial devices

- Robot controller
- Electric actuator
- Stepping motor
- Network signal tower
- Temperature controller etc.

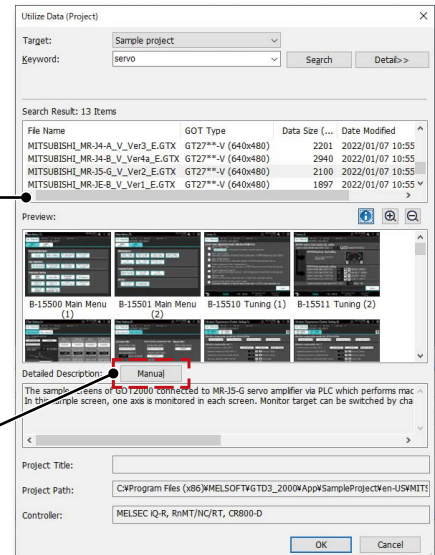

FA Integrated Engineering Software MELSOFT iQ Works

MELSOFT iQ Works is an integrated software suite consisting of GX Works3, MT Works2, GT Works3, RT ToolBox3*1 and FR Configurator2, which are programming software for each respective product. Integration is further enhanced with MELSOFT Navigator as the central system configuration incorporating an easy-to-use, graphical user interface with additional project-sharing features such as system labels and parameters. The advantages of this powerful integrated software suite are that system design is made much easier with a substantial reduction in repetitious tasks, cutting down on errors while helping to reduce the overall TCO.

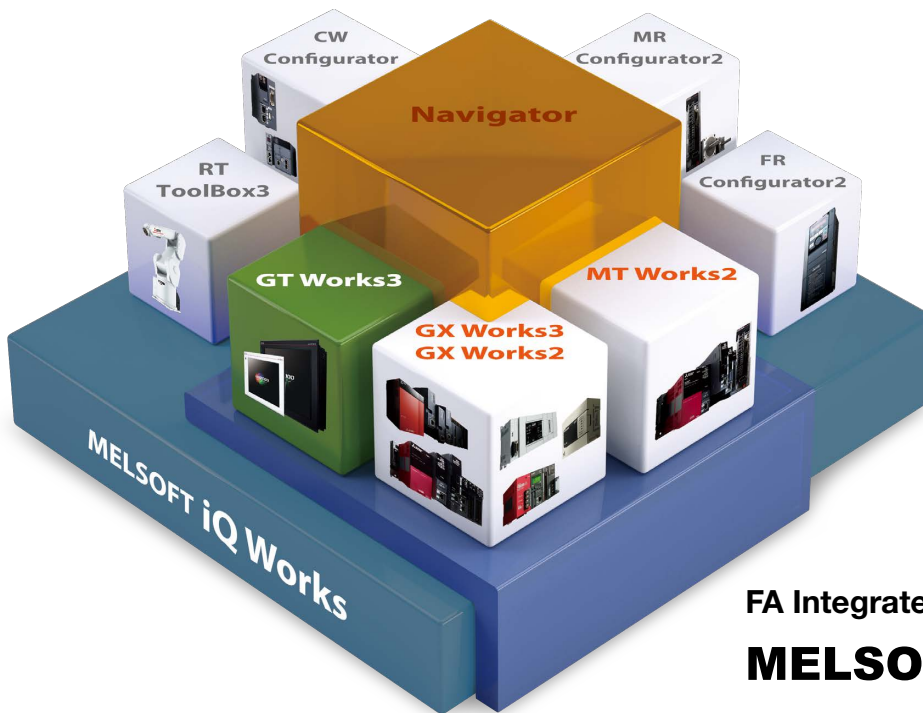

FA Integrated Engineering Software MELSOFT iQ Works

System management software

MELSOFT Navigator

System level graphic-based configuration tool that simplifies the system design by providing a visual representation of the system. System management features such as system-wide parameterization, labels and block reading of project data are also included.

Programmable controller engineering software

MELSOFT GX Works3

GX Works3 is the latest generation of programming and maintenance software offered by Mitsubishi Electric specifically designed for the MELSEC iQ-R Series control system. It includes many new features such as graphic-based system configuration, integrated motion control setup, multiple language support, providing an intuitive engineering environment solution.

HMI/GOT screen design software

MELSOFT GT Works3

This integrated software is used to create professional screen designs for GOTs. Developed with the concepts of simplicity, sleekness, and user-friendliness in mind, this is a powerful tool that pushes boundaries and delivers endless design possibilities.

Motion controller engineering software

MELSOFT MT Works2

This motion control design and maintenance software includes intuitive graphic-based programming together with a digital oscilloscope simulator.

Robot engineering software

MELSOFT RT ToolBox3*1

Inverter setup software

MELSOFT FR Configurator2

C Controller setting and monitoring tool

MELSOFT CW Configurator

Servo setup software

MELSOFT MR Configurator2

*1 RT ToolBox3 mini (simplified version) will be installed if iQ Works product ID is used. When RT ToolBox3 (with simulation function) is required, please purchase RT ToolBox3.

MELSOFT Navigator

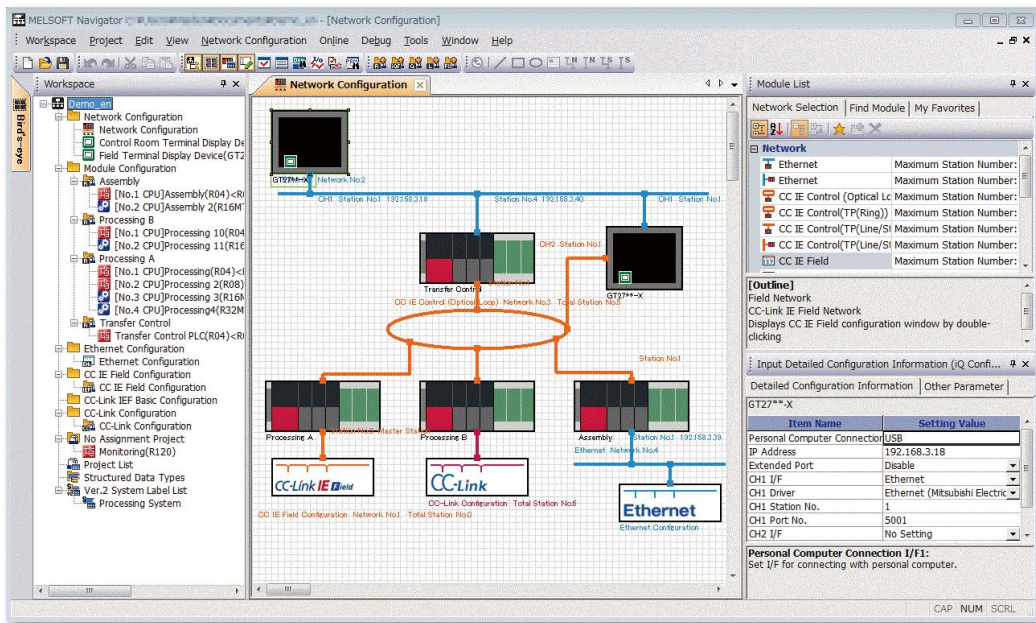

■ MELSOFT Navigator enables interaction with iQ Works

Share labels among projects

Labels can be shared among GX Works3, MT Works2, and GT Works3 so that if the device assignment is changed in one project, the changes are automatically applied to other projects.

No need to set parameters for each tool*2

The information set in the system configuration diagram can be applied in a batch to each program in GX Works3, GX Works2, MT Works2, and GT Works3. There is no more need to start up each software and check the consistency.

*2 Detailed parameters must be set with each tool.

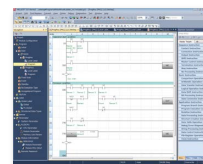

Programmable Controller Engineering Software MELSOFT GX Works3

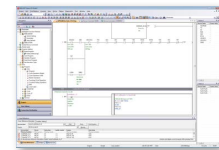

Programmable Controller Engineering Software MELSOFT GX Works2

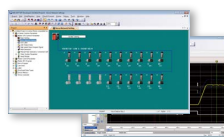

Motion Controller Engineering Software MELSOFT MT Works2



HMI/GOT Screen Design Software MELSOFT GT Works3

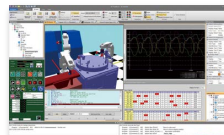

Robot Engineering Software MELSOFT RT ToolBox3*1



Inverter Setup Software MELSOFT FR Configurator2

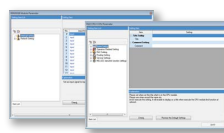

Setting/monitoring tools for the C Controller module/MELSECWinCPU MELSOFT CW Configurator



Servo Setup Software MELSOFT MR Configurator2

*1 RT ToolBox3 mini (simplified version) will be installed if iQ Works product ID is used. When RT ToolBox3 (with simulation function) is required, please purchase RT ToolBox3.

HMI/GOT Screen Design Software

MELSOFT GT Works3

Easily create professional screens!

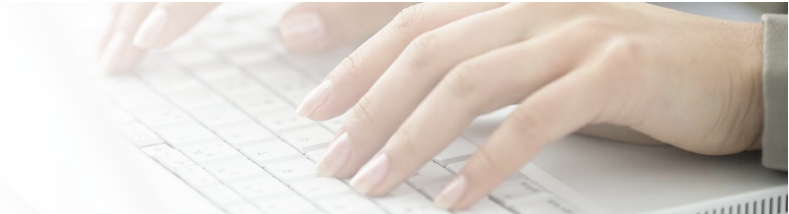

Easily manage project data

Work tree

Easily create stylish screens

GOT Graphic Ver.2

P.122

MELSOFT GT Works3

The screenshot displays the MELSOFT GT Works3 software interface. On the left, a 'Project' work tree shows a hierarchical structure of project elements. The main workspace features a 'Main Operation Panel' with various controls: 'Start Operations' (Normal, Error, Running, Manual Auto), 'Speed', 'Temperature', and 'Current' gauges, 'Device Monitor' (X0001~X0008, Y0001~Y0008), and 'Set Temperature' (120.0, 98.5, 160.0, 150.5). Below the main panel is a 'Line Operations' section with buttons L1-L6 and a table with columns 'No.' and 'Record Name' containing entries like 'Beef curry', 'Chicken curry', and 'Seafood curry'. At the bottom, a 'Data Browser' window shows a table of project items, and a 'Device Search' window displays search results for devices.

Item	Screen	Monitor Devi...	Data Type	Group No.	Comment No.
Line	B-2002				
Polygon	B-2002				
Graphical Meter	B-2002	GD20137	Signed BIN 16		
Graphical Meter	B-2002	GD20131	Signed BIN 16		
Rectangle	B-2002				
PNG	B-2002				
Table	B-2002				

Device	Screen	Function	ID/No.	Data Type	Network
GB40	B-201	Script Trigger	1	Bit	
GB40	B-103	Script Trigger	1	Bit	

Easily check the settings

Data browser

P.125

Quickly search devices and labels

Device search

P.126

Reduce screen creation time

Utilize data (Screens)	120
Utilize data (Projects)	121
Automatic scaling when changing GOT type	121
Script parts	121

Support screen creation

GOT Graphic Ver.2	122
Label/Global label	124
Data browser	Upgraded 125
Screen image list (thumbnail display)	125
Alarm display (user/system)	126
Device search	126
Consecutive copy	Upgraded 127
Reflecting [Comment Group No.], [Comment No.], [Part No.] to objects	127
Improved Ethernet settings	Upgraded 128
Template	129
e-Manual	130

Easily create stylish screens

Align	131
Graphical meter	131
Logo text	131

Support debugging

Simulator	132
Data verification	132
Data check list	133

Support startup work

Data transfer (batch write to multiple GOTs)	133
--	-----

Support maintenance

GOT offline monitor	NEW 134
Resource file viewer	NEW 135

Support globalization

Speech synthesis function	136
Language switching	136
FA Term Translation Tool	Upgraded 137

Screen design tips movie (Japanese) 

Easily create stylish screens
Library

Create stylish, clear meters
Graphical meter P.131

Easily create tables
Table

Quickly display screen thumbnails
Screen image list P.125

Search by keywords and effectively use data
Utilize data (Screens) P.120

Reduce screen creation time

Utilize data (Screens)

Individual screens can be utilized from past projects and sample projects. Select screens to utilize, then drag and drop to launch the utilization wizard. Just by following simple step, screen data can easily be utilized.

Easy searches from category lists

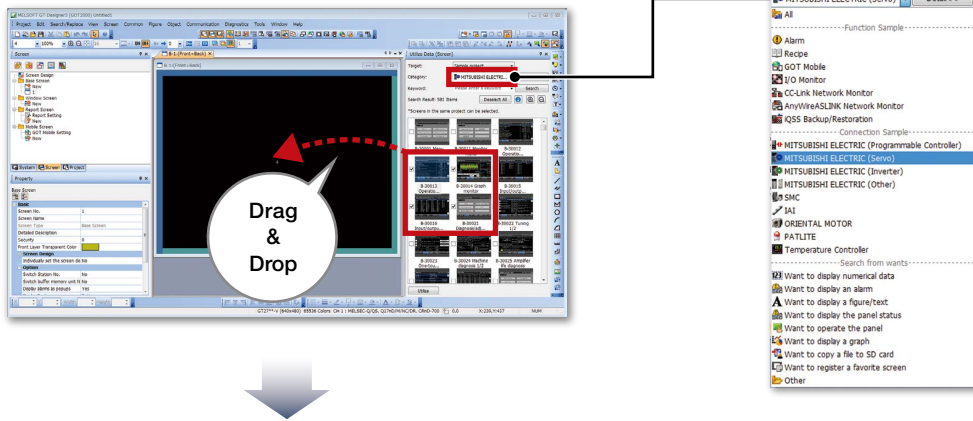

Utilization wizard

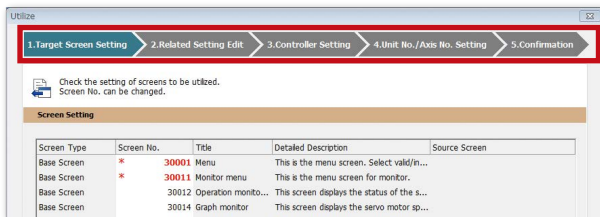

Simple step navigation

1. Target screen setting
The screen number is displayed in red if it is used in the project being edited.

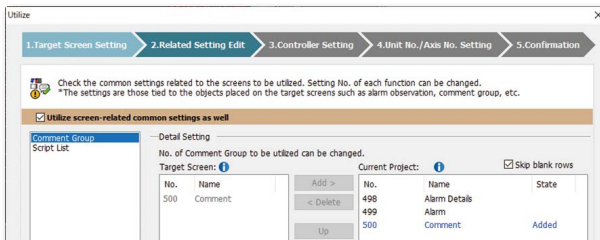

2. Editing related settings
Comment groups and scripts related to the target screen can also be utilized at the same time.

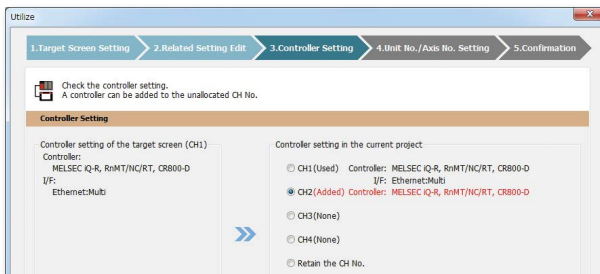

3. Controller setting
Target screen controller settings can be assigned to an empty channel in the currently editing project.

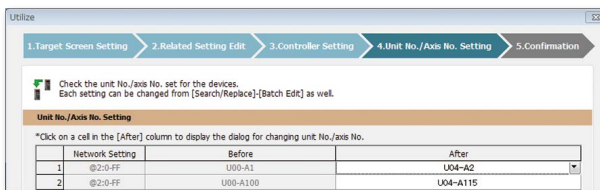

4. Unit No./Axis No. setting
When utilizing screens whose system configuration is different, you can easily change the unit No. and the axis No. of the target screen.

5. Checking setting contents

■ Utilize data (Projects)

When creating a new project, search through the existing projects to find any existing projects that may be reused. Keyword search helps narrow down the search.

Specify search range
Select "Sample Project" to reuse a sample project.

Select or input a keyword
Select a prepared keyword or input an arbitrary keyword.

Search results are displayed

Choose the applicable project from the search result

Procedure: [Project] → [Utilize Data]

■ Automatic scaling when changing GOT type

More objects are automatically scaled when changing to GOT types with different resolutions. It is now easier than ever to utilize screens of different resolutions, making the work process more efficient.

Target objects: Alarm display, simple alarm display, system alarm display, historical data list display, data list display, recipe display (record list)

When changing the GOT type resolution from VGA to SVGA

Previously

Automatic scaling

Increased usability

Before change (VGA)

After change (SVGA)

The alarm display and historical data list display are also automatically enlarged. No need for size adjustments!

Procedure: [Common] → [GOT Type Setting] → [Perform Automatic Scaling on the positions/sizes of figures and objects] → [Option]

■ Script parts

Make scripts into objects and use them as script parts. The following operations are available, improving operability.

- Copying and pasting to another screen, grouping, registering to the library, adding to a template

Support screen creation

■ GOT Graphic Ver.2

Screen design

Screen design can be selected from various designs by theme. Simply select your favorite design from presets to change all screen backgrounds at once. You can keep screen design consistent across the entire project and reduce steps in the process. In addition, the screen design can be customized to create favorite design.

Pre-installed screen designs

Select one of the screen designs pre-installed in GT Designer3. You can easily set a screen design without paying attention to the setting items. Each screen can be customized individually.

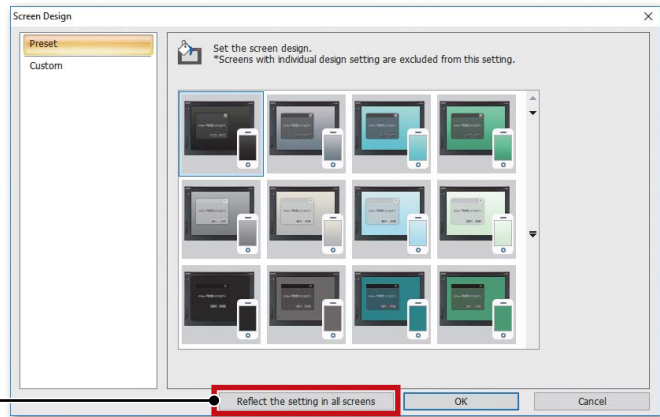

Change the design for all screens at once

Customized screen designs

Customize a screen design. You can customize the background color, design of window screens, and other settings of a screen design selected from the pre-installed screen designs.

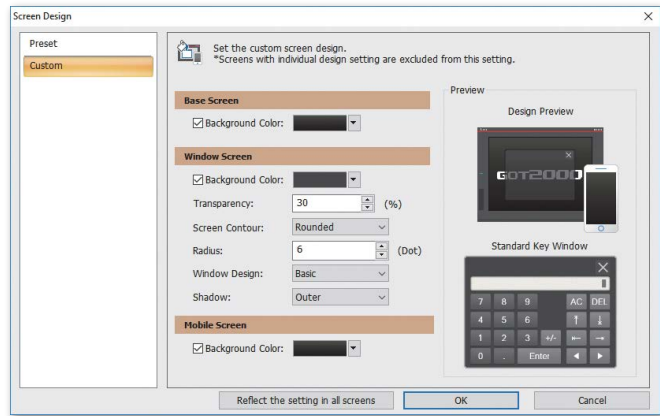

Contour shapes of window screens

Both square and rounded contours are available for window screens. The radius can be adjusted for rounded contours.

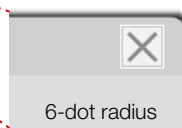
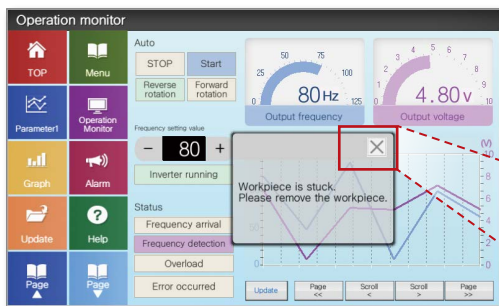

Set your desired radius in one dot increments

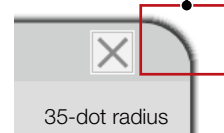

Transparent window screen and alarm popup display

The background color transparency can be changed in window screens. You can check and control the window screen while viewing the overall image of the base screen. Alarm popups turn transparent as well so that they do not block the base screen underneath.

Configure the transparency of the window screen

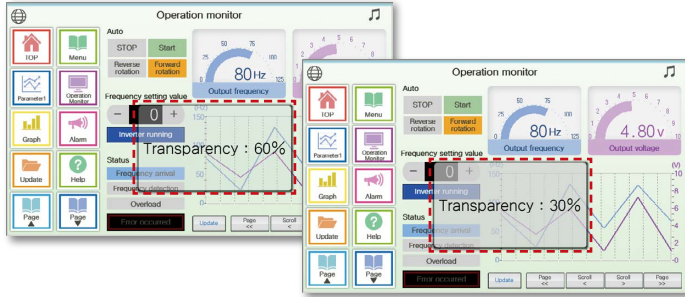

Transparent alarm popup display

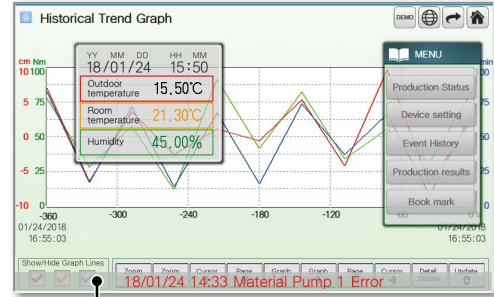

Alarm popup

Stylish system key window

Multiple system key windows are available for your screen design. Select a preset that fits your screen design to use a matching numeric keypad. The key window is made transparent when moved so that you can check the screen underneath.

* Not supported by GT21 and GS21.



Figure antialiasing

Antialiasing is available for figure contours in addition to on-screen text. Overall screen display is smoother for stress-free, stylish screen design.

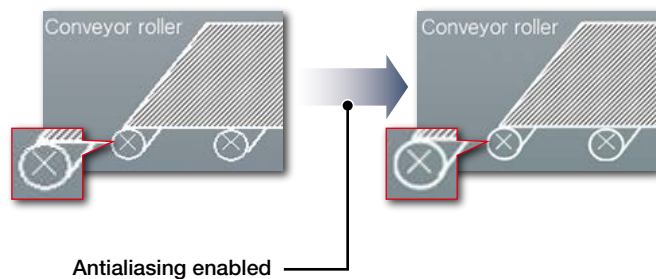

Procedure: [Common] → [GOT Type Setting] → Graphics Setting [GOT Graphic Ver.2]

Support screen creation

Label/Global label

Label

Instead of using devices, use label names to create easy-to-understand project data efficiently. Not only Mitsubishi Electric programmable controller devices, but also non-Mitsubishi Electric controller devices and GOT internal devices can be assigned to labels. Labels can be used in GT Works3. In addition, global labels can be imported from GX Works3, GX Works2, and MT Developer2.

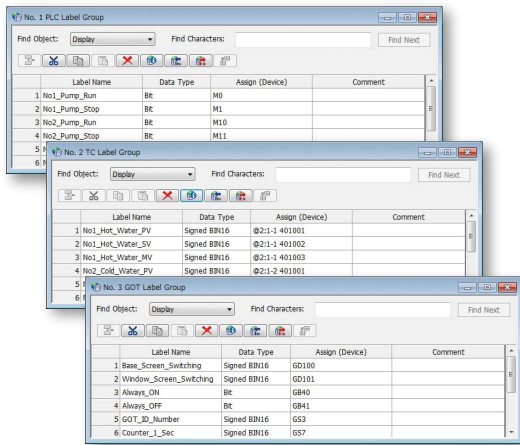

1 Set label names and assign devices

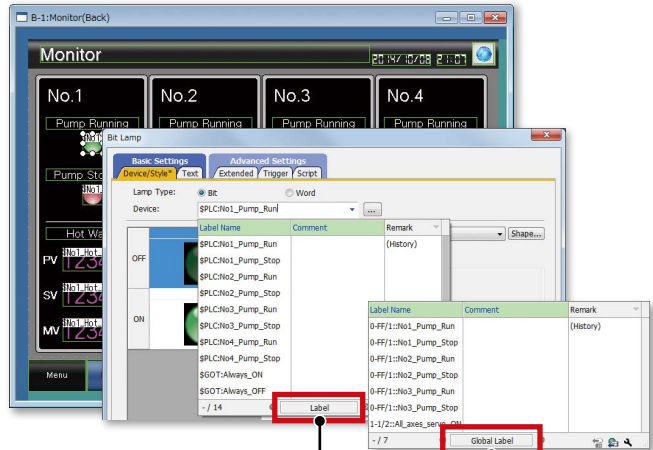

2 Select a label name when setting objects (Direct input is also possible.)

Select a type

Procedure: [Common] → [Label] → [New Label Group]

Global label*

Global labels are used for connection to RCPUs, Motion CPUs (MELSEC iQ-R Series), or Motion modules only. By using global labels, you can create the project data without paying attention to the actual devices. To use global labels of GX Works3, MT Developer2, or Motion Control Setting Function, import them to GT Designer3.

Global labels for RCPUs (GX Works3) are useful since they can be imported from the project data at a time.

Global labels for Motion CPUs (MT Developer2) are imported from CSV files.

* Not supported by GT21 and GS21.

* Double-precision real numbers are supported.

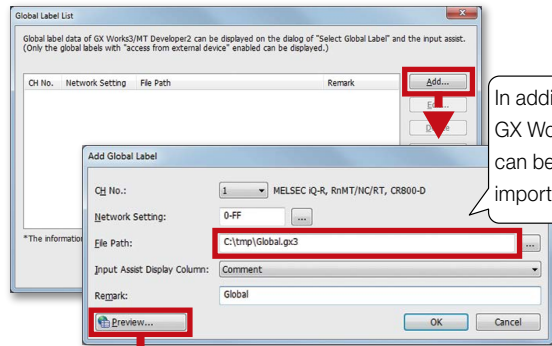

In addition to CSV files, GX Works3 project data can be specified to import global labels.

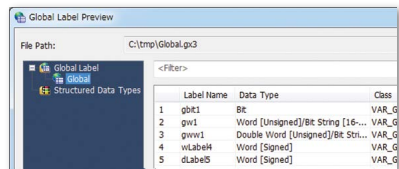

Global labels and structure data can be checked with preview before importing.

Procedure: [Project] → [Import Other Data] → [Global Label]

Notifying change of global labels

Check if there is a change in the GX Works3 project or CSV file specified when global labels are imported with the following methods.

- Notification icon in the status bar

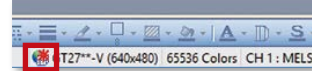

- [Select Global Label] dialog, [Global Label Reference] dialog

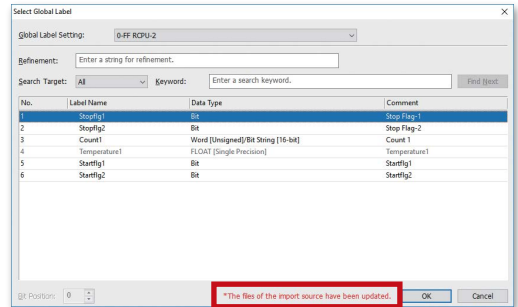

Upgraded

■ Data browser

The data browser shows a list of objects used in the project. The settings can be edited directly on the browser or by opening the setting dialog. You can easily identify any duplicate data and no longer have to open multiple screens.

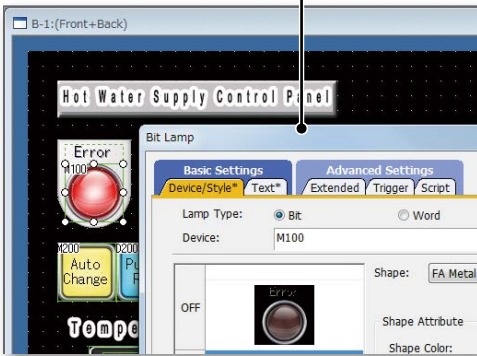
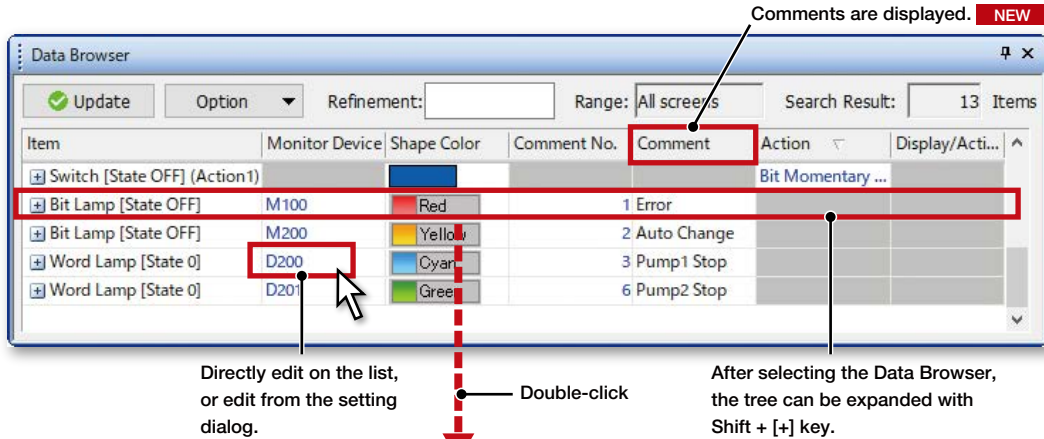

- **Display targets**
Figures, objects, screen scripts, screen trigger actions
- **Editable details**
Directly edit devices and text, etc.
Change devices, text, colors, and figures in a batch
Change action settings, fonts, and figures
Change range settings of numerical displays and other objects
Copy/paste multiple cells
Sort and narrow down items by using devices/keywords
Interchange columns with drag & drop

Procedure: [Search/Replace] → [Data Browser]

Procedure: [View] → [Docking Window] → [Data Browser]

Shortcut key: Ctrl + E

■ Screen image list (thumbnail display)

Created screens can be displayed and checked in the screen image list window as thumbnails. By viewing the screen image list, it is easy to look for the screen you need. It is convenient to copy or delete screens on the window.

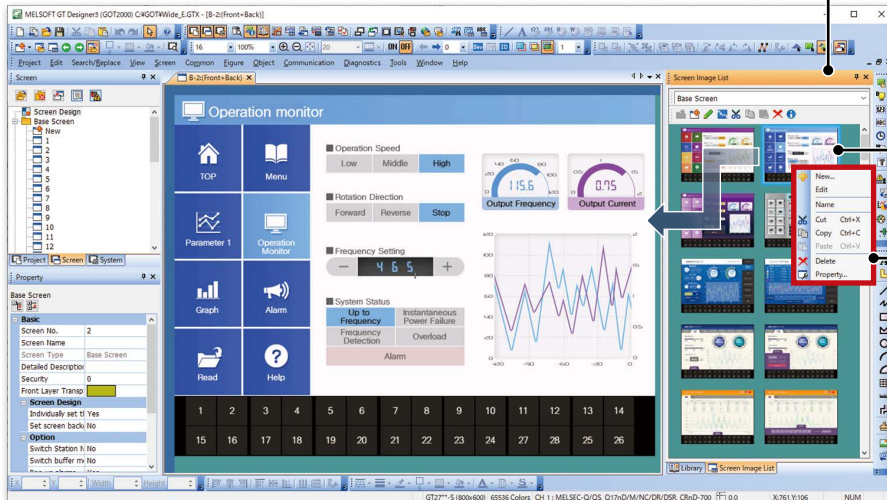

Greatly improved speed to display screen images

* Settings are required to speed up the display. For the details, please refer to the relevant product manual.

Double-click a screen on the window and display it on the screen editor

Copy or delete the screen on the window

Procedure: [Display] → [Docking Window] → [Screen Image List]

Support screen creation

Alarm display (user/system)

The alarm display lists the collected user alarms or system alarms*1. When placing an alarm display, operation switches are arranged at the same time. There is no need to select operation switches for the alarm display separately, thus reducing time for screen design.

*1 GT21 and GS21 do not support the system alarm function.

GT27/GT25/GT23/GT2107-W/
GT2104-R/GS21

OCCURRED	COMMENT	REST.	CHECK
10/18/19 11:40		11:40	11:40
10/18/19 11:40		11:40	11:40
10/18/19 11:40		11:40	11:40
10/18/19 11:40		11:40	11:40
10/18/19 11:40		11:40	11:40
10/18/19 11:40		11:40	11:40
10/18/19 11:40		11:40	11:40
10/18/19 11:40		11:40	11:40
10/18/19 11:40		11:40	11:40
10/18/19 11:40		11:40	11:40
10/18/19 11:40		11:40	11:40
10/18/19 11:40		11:40	11:40
10/18/19 11:40		11:40	11:40
10/18/19 11:40		11:40	11:40
10/18/19 11:40		11:40	11:40

Cursor ON	Up	Check	Delete	Save
Cursor OFF	Down	Check all	Delete all	Reset

GT2103-P

OCCURRED	COMMENT	REST.
19/10/18 11:44		11:44
19/10/18 11:44		11:44
19/10/18 11:44		11:44
19/10/18 11:44		11:44
19/10/18 11:44		11:44
19/10/18 11:44		11:44

Operation switches are arranged at the same time

Procedure: [Object] → [Alarm Display] → [Alarm Display (User)/Alarm Display (System)]

Device search

Search the current project for devices, labels, or tags. By quickly checking the device use status, you can identify which functions use the found devices, and change the related settings. Keyword search narrows down the search results.

Search by device

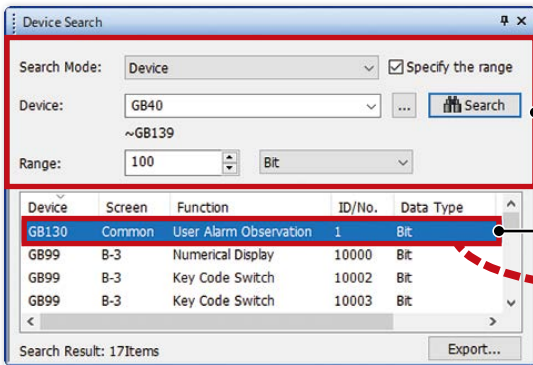

Set details of search conditions

Double-click to jump to the device setting (jump to Common Settings is also possible)

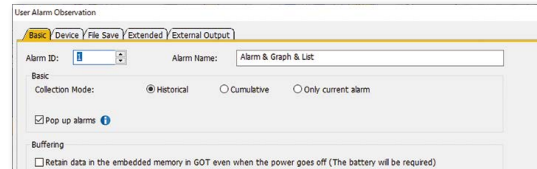

Quickly display the search results.
Search without worrying about device type and data length.

Search all devices when the [Device] field is empty

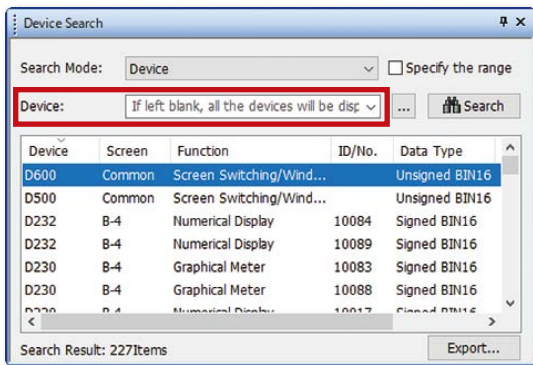

Search by keyword is also available

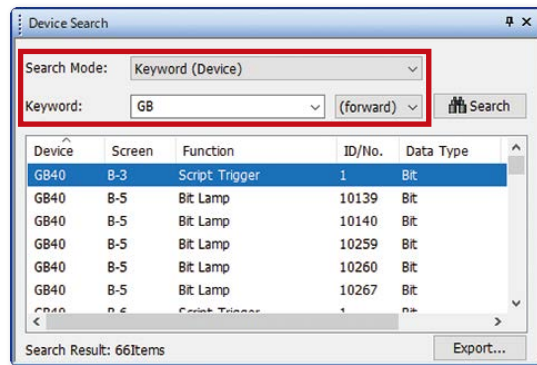

Procedure: [Search/Replace] → [Device Search]
Shortcut key: Ctrl + F

Upgraded

Consecutive copy

Upgraded features of consecutive copy can reduce screen creation time. Consecutive copy can be used to copy and paste selected figures and objects (switches, lamps, etc.) at a time based on the settings.

[Comment Group No.], [Comment No.], [User ID], and [Move Destination ID] have now been added to the increment target to allow for more efficient screen design work.

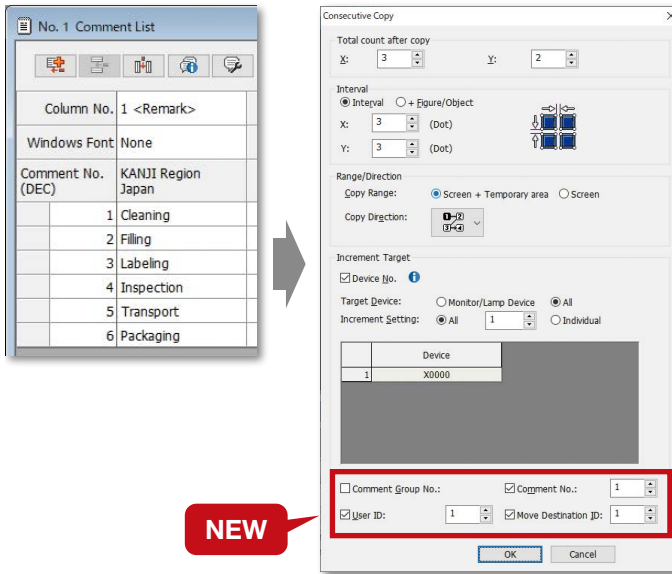

Previously

The text of the same comment No. was shown because the comment No. was not incremented.

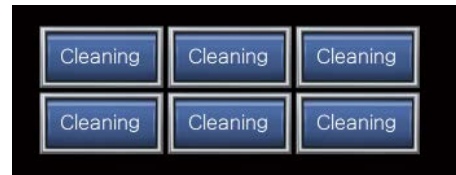

NEW

The comment No. is incremented as well. There is no need to change the setting.

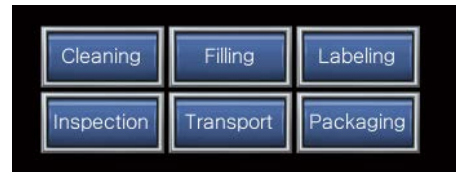

Reflecting [Comment Group No.], [Comment No.], [Part No.] to objects

When changing comment group No., comment No., or part No., the number being set to objects are changed accordingly.

In the [Option] dialog, select whether or not to reflect the change to the object settings when changing the numbers.

Changing comment No.

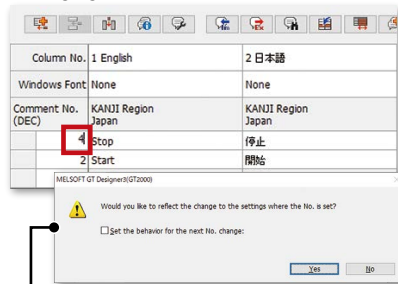

Display the confirmation message whether to reflect the change.
(Settings are made in the [Option] dialog)

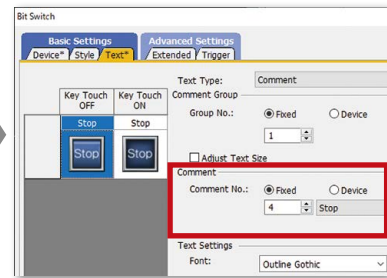

Reflect the change to the object where the comment is used.

Support screen creation

Upgraded

Improved Ethernet settings

Visibility of the system tree for Ethernet settings has been improved. In addition, by showing IP addresses used in the project in a list, it is easy to notice setting errors such as address duplication.

Improved visibility by listing controllers and IP addresses in the Controller Setting section of the system tree.

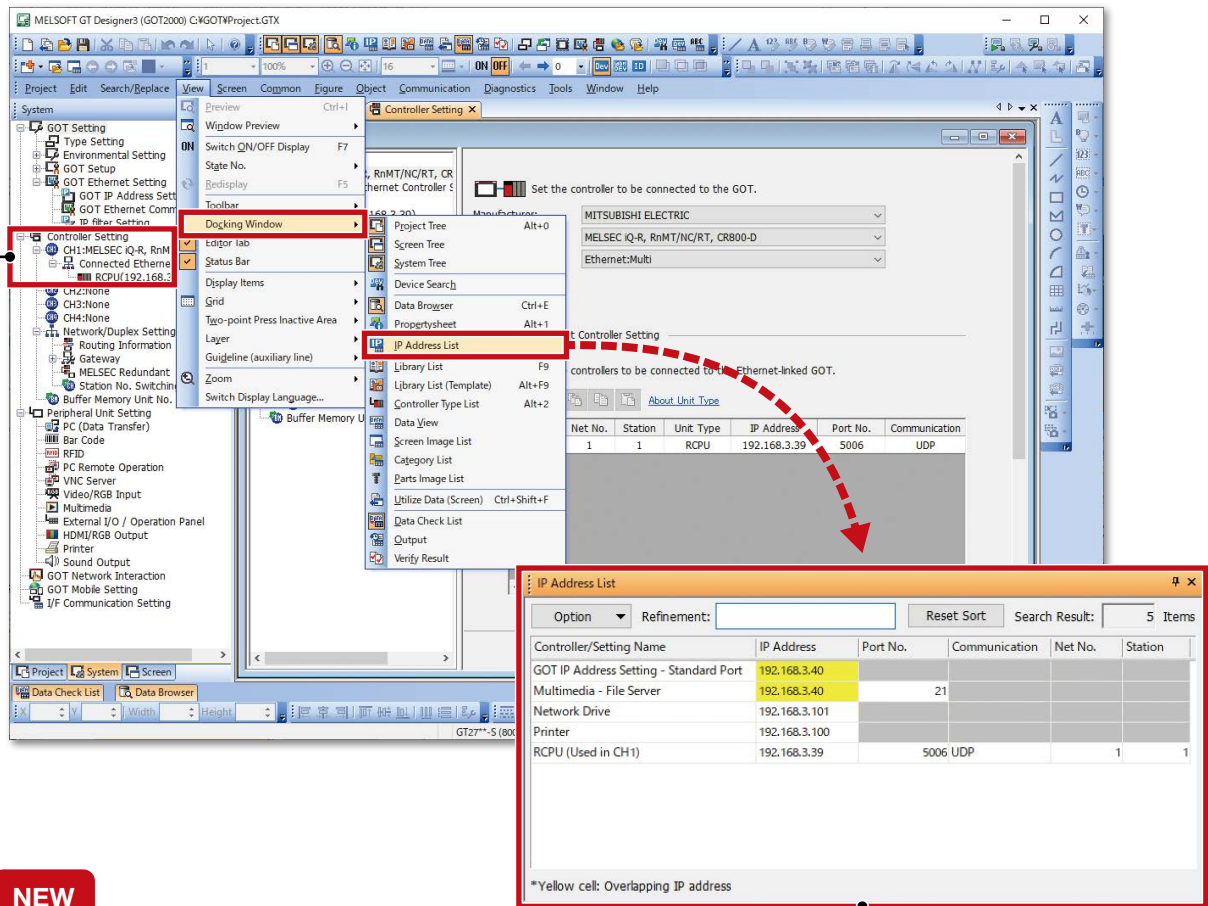

NEW

[IP Address List] docking window

Duplicated IP addresses are notified by changing the color of the cells to yellow. In addition to the connected controllers, IP addresses in [Printer], [Network Drive], and other settings can be checked in a list.

■ Template

Customize each template to the desired look-and-feel, ranging from color options to device selection. Attributes such as devices and colors can be set for each template.

You can easily change devices and colors by associating each object with the template's attribute.

Make batch changes with simple settings

Change color from green to red

Colors and devices are changed in a batch

Template attributes (color)

- Historical trend graph line color
- Text color
- Numerical display value color
-

Items that can be registered in templates
Figures, Objects

Attributes that can be registered and changed in templates
Device (Bit, Word), Numerical value, Text, Color, Figure, Font, Text size

• Selecting from library

Procedure: [View] → [Docking Window] → [Library List (Template)]

Shortcut key: Alt + F9

• Creating template

Procedure: Select object → Right-click → [Template Registration] → [Register to Template]

Support screen creation

Concept movie



e-Manual

e-Manual is the Mitsubishi Electric FA Electrical Document Manual with a dedicated viewer (e-Manual Viewer). Useful functions are included such as keyword search of multiple manuals, saving your favorites, saving memos, and others.



- 1 Install e-Manual Viewer
- 2 Always download the latest manuals. Easy to update with just one click!
- 3 Increase your screen design efficiently

Quickly confirm with F1 key

Press the F1 key in GT Works3 and jump to e-Manual for the dialog being edited! Quickly check setting methods and other information!

GT Works3

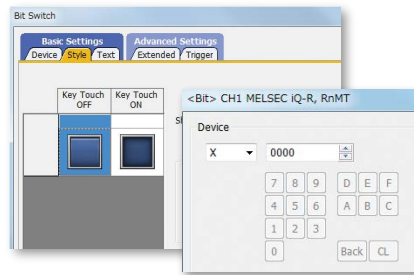

e-Manual

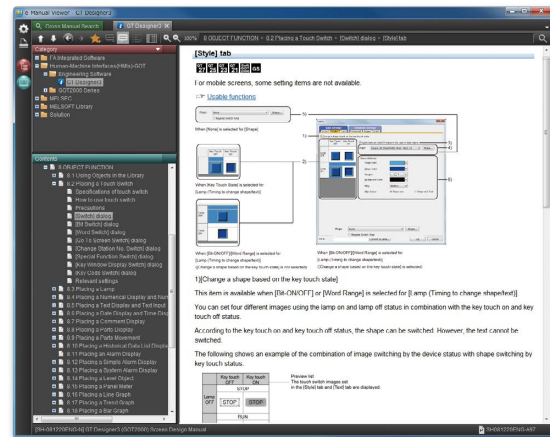

Easy to view, easy to use!

Easy to view contents, easy to use, useful functions help you access manuals efficiently. Quickly search for the information you need.

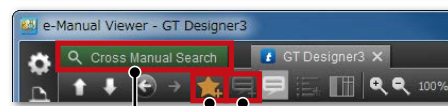

Cross Manual Search
Search required information from multiple manuals by keyword. You can get to the information you need without opening manuals one by one.

Bookmark
Bookmark frequently used manuals and pages and you can check the information quickly.

Note
Take a memo, such as know-how, and add it to the manual and you can customize manuals as you like.

Procedure: [Help] → [GT Designer3 Help]
Shortcut key: F1

* For the details, please contact your local sales office.

Specification details and restrictions

<GOT manuals available in e-Manual>

- **Manual name** GOT2000 Series User's Manual (Hardware), GOT2000 Series User's Manual (Utility), GOT2000 Series User's Manual (Monitor), GT Designer3 (GOT2000) Screen Design Manual, and various other manuals

<e-Manual Viewer Windows® version>

- **Supported OS** Microsoft® Windows® 10, Microsoft® Windows® 8.1, Microsoft® Windows® 8, Microsoft® Windows® 7
- **How to obtain e-Manual** e-Manual is included in GT Works3 Ver.1.155M or later. For the details, please contact your local sales office.

<e-Manual Viewer tablet version>

- **Supported OS** Android™ 4.3/4.4/5.0, iOS 8.1 or later
- **How to obtain e-Manual** e-Manual is available for download from application distribution sites. (Search by "Mitsubishi Electric e-manual")



Tablet version (Android™)
* Japanese site



Tablet version (iOS)
* Japanese site

Easily create stylish screens

Align

Selected figures and objects are aligned to the anchored figure or object according to the specified alignment type.

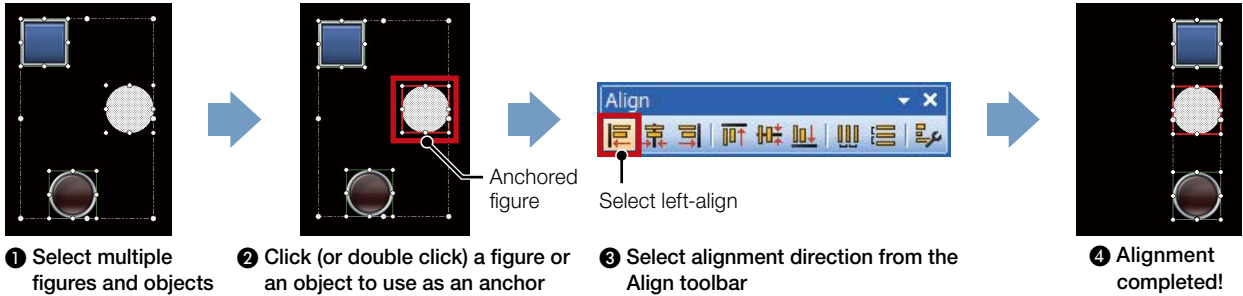

Graphical meter

Just select a meter from the preset list and you can create stylish, clear meters. The position and angle of scales can be adjusted by mouse operation and the shape and design can be changed easily. Warning color display indicates the machine status clearly.

Select from the toolbar

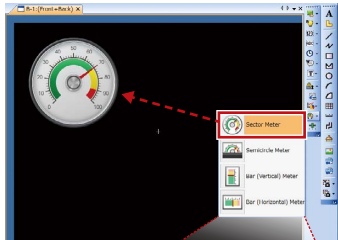

Select meter shape

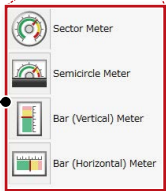

Select from the preset list



The list includes various choices

Easy to adjust settings by mouse operation

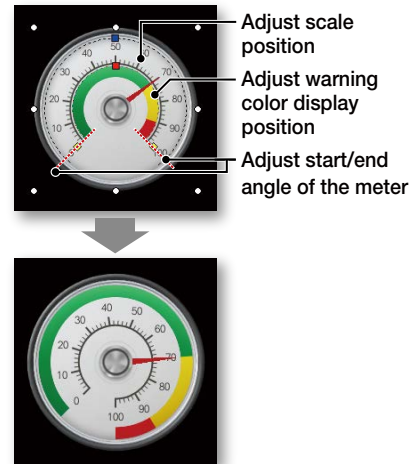

Procedure: [Object] → [Graphical Meter]

Logo text

The background of the logo text can be made transparent.

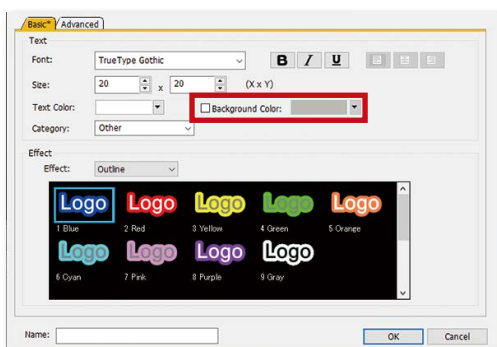

With background color



Without background color

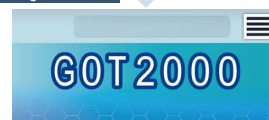

Uncheck the [Background Color] checkbox to make the background of the text transparent.

Support debugging

■ Simulator

Since the operation of the project data can be confirmed on the personal computer, the program can be efficiently debugged while making changes on the screen. Even if hardware is not available, the operations can be confirmed with a personal computer and sequence programs. The screen images can be printed and saved, and easily used when creating specifications and operation manuals.

* GX Works3, GX Works2, GX Simulator, or MT Works2 is required separately. (It varies depending on the CPU to simulate.)

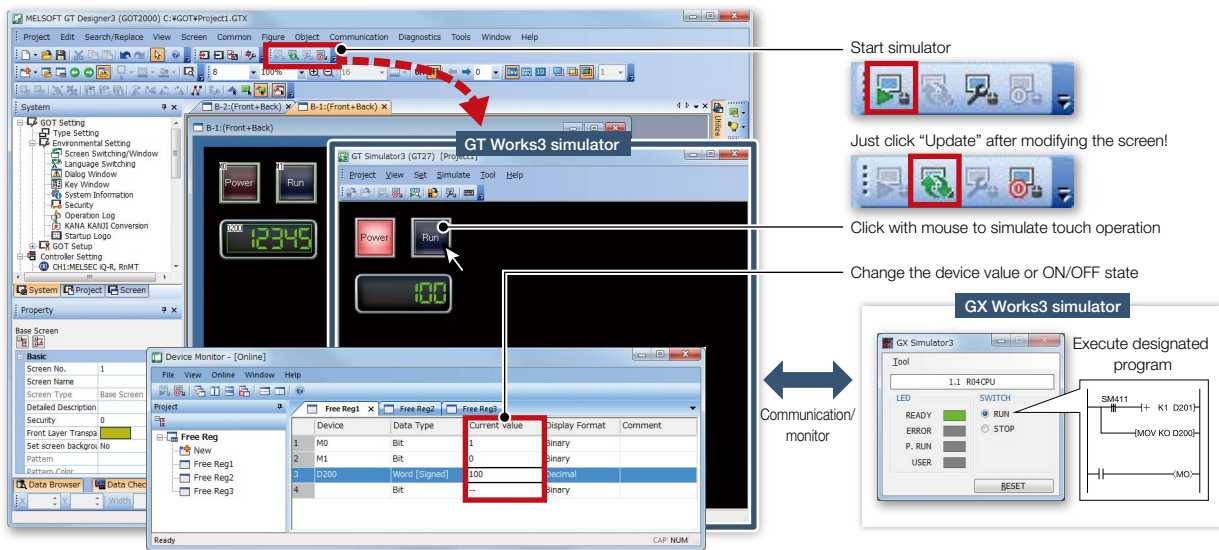

Procedure: [Tools] → [Simulator] → [Activate]

Shortcut key: Ctrl + F10

■ Data verification

Verify the project data and check the results for each screen/object.

From the Verify Result window, you can jump to the target object or can narrow down results by items such as the screen type. This function enables you to check differences and modify the data quickly even if the project data includes many screens.

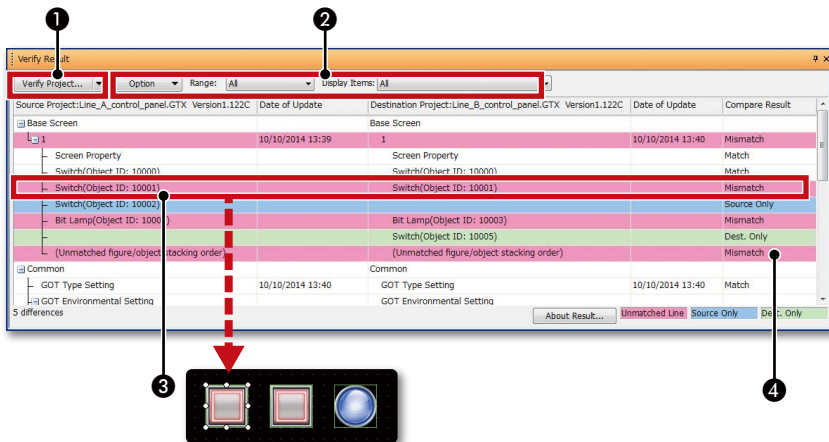

- 1 Verify Project (verifying the project being edited against one in a personal computer) and GOT Verification (verifying the project being edited against one in the GOT) are available.
- 2 Export of verified results and refinement by items such as screen type are possible.
- 3 Double-click on an error or warning line to jump to the corresponding object.
- 4 The background color of a row varies according to the type of a difference.
 Pink: The item exists in both projects and the data are not matched
 Blue: The item exists only in the source project
 Green: The item exists only in the destination project

• Project verification

Procedure: [Project] → [Verify Data]

• Verification with GOT

Procedure: [Communication] → [Verify GOT] * In the Verify Result dialog, select [Output to Verify Result (window)] to display the above Verify Result window.

■ Data check list

The touch switch quantity and overlapping state, object quantity and illegal devices are checked and the results are displayed as a list. Double-click on an error or warning line to jump to the corresponding object. Quickly identify errors and warning objects.

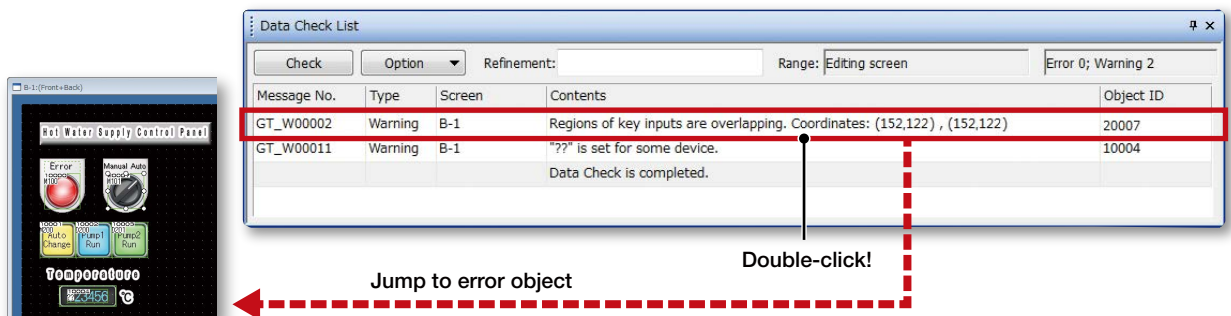

Procedure: [Tools] → [Data Check] → [Check]
 Procedure: [View] → [Docking Window] → [Data Check List]

Support startup work

■ Data transfer (batch write to multiple GOTs)

Single package data (project data, communication drivers, etc.) can be installed on multiple GOTs connected via Ethernet at once. (Maximum 256 GOTs)

Batch installation on multiple GOTs reduces data transfer time and prevents data update omission. When multiple GOTs share the same project data on a large equipment, this feature reduces screen correction and update tasks.

* Supported by GT2107-W, GT2104-R, and GT2103-PMBD among GT21 models.

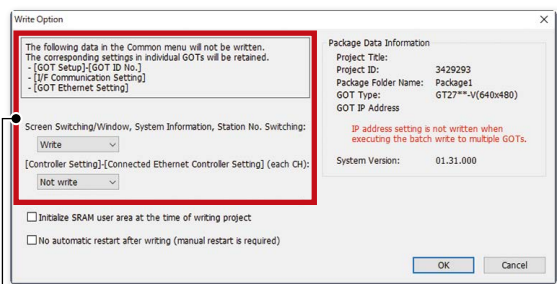
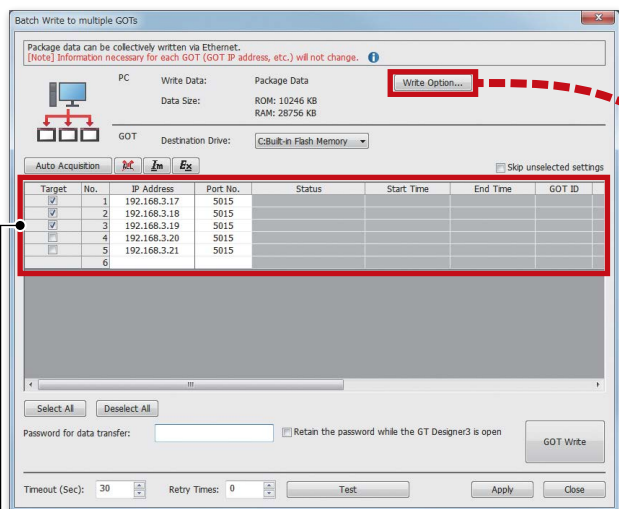
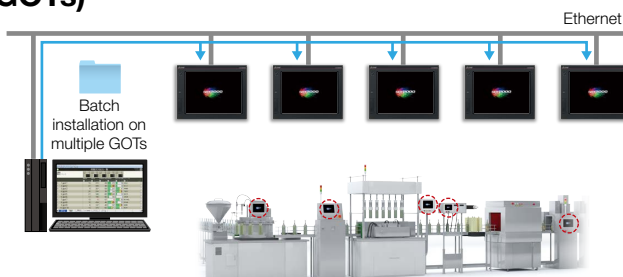

- Set whether to write the following settings.
- Screen Switching/Window, System Information, Station No. Switching
 - [Connected Ethernet Controller Setting] in the [Controller Setting] (each channel)

If [Not write] is selected, settings in each target GOT remain unchanged.

The GOT identification information including the GOT IP address are automatically acquired, and the target to perform batch installation can be selected.

Procedure: [Communication] → [Batch Write to multiple GOTs]

Support maintenance

NEW

GOT offline monitor

The GOT offline monitor graphically displays device values of the data (recording file) that was recorded by the system recorder before and after a problem occurrence on a personal computer.

Since the operation screen and the program having the same time stamp can be reproduced along with the operation of the seek bar on GX Works3, the actual operation and the state of the equipment can be checked simultaneously, thus helping to identify the cause of the problem quickly.

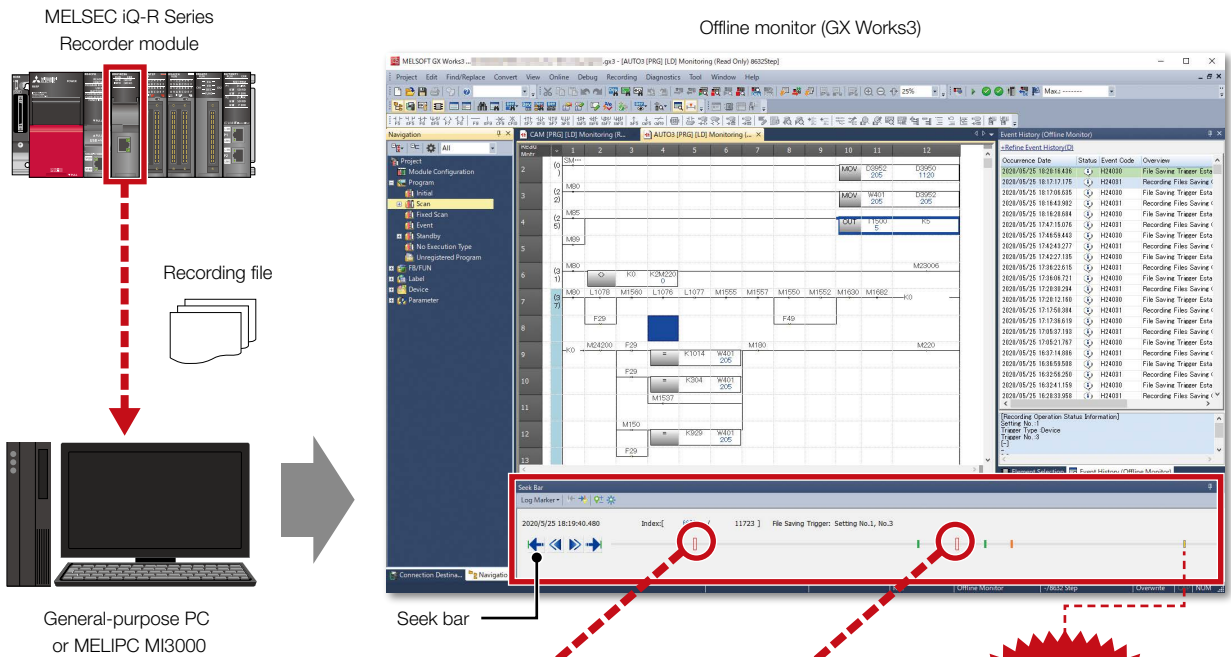

Equipment error!

GOT offline monitor (GT Designer3)

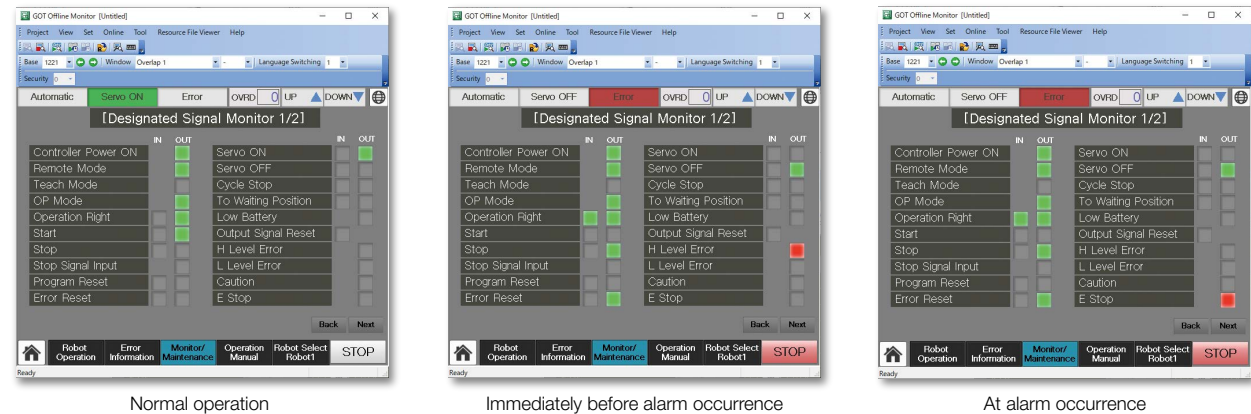

Seek bar

Seek bar is the function to specify the index (consecutive number that is recorded for each scan of the recording file) of the data to monitor.

Operating the slider on the seek bar enables to jump to the event information of the specified index or to check the data by synchronizing the time with the GOT offline monitor.

MELSOFT GT Works3

NEW

Resource file viewer

The resource file viewer displays the operation history and the alarm history from the resource files recorded on GOT.

By synchronizing the time between the seek bar of the offline monitor (GX Works3) and the events (operation history, alarm history) on GOT, the relationship between the event data before and after an alarm occurrence and the flow of a program can be checked.

* Not supported by GT21 and GS21.

Offline monitor (GX Works3)

GX LogViewer

Event and waveform data at an alarm occurrence

Seek bar

Jump to the operation/alarm history having the same time stamp indicated by the seek bar

Jump to the program that ran at the same time as the operation/alarm history

Resource File Viewer: 1 [Monitoring]

Comment	Alarm Status	Occurred	Restored	Checked
H0019 Initialize (error log)	R	2020/05/25 18:21:34	2020/05/25 18:22:04	*****/**/****
C8010 The robot model was selected.	R	2020/05/25 18:22:04	2020/05/25 18:22:04	*****/**/****
C8102 Temperature in the Controller is too hi.	R	2020/05/25 18:22:34	2020/05/25 18:22:58	*****/**/****
H0400 Alarm of fan in the robot	R	2020/05/25 18:22:58	2020/05/25 18:23:04	*****/**/****
H0400 Alarm of fan in the robot	R	2020/05/25 18:23:10	2020/05/25 18:23:16	*****/**/****
C1770 Origin setting incomplete	R	2020/05/25 18:23:16	2020/05/25 18:23:58	*****/**/****
C1892 Cooling fan low rev. (add axis)	R	2020/05/25 18:23:20	2020/05/25 18:23:29	*****/**/****
C2740 CMP error (coordinates conv.)	R	2020/05/25 18:23:34	2020/05/25 18:23:13	*****/**/****

Comment	Alarm Status	Occurred	Restored	Checked
H0019 Initialize (error log)	R	2020/05/25 18:21:34	2020/05/25 18:22:04	*****/**/****
C8010 The robot model was selected.	R	2020/05/25 18:22:04	2020/05/25 18:22:04	*****/**/****
C8102 Temperature in the Controller is too hi.	R	2020/05/25 18:22:34	2020/05/25 18:22:58	*****/**/****
H0400 Alarm of fan in the robot	R	2020/05/25 18:22:58	2020/05/25 18:23:04	*****/**/****
H0400 Alarm of fan in the robot	R	2020/05/25 18:23:10	2020/05/25 18:23:16	*****/**/****
C1770 Origin setting incomplete	R	2020/05/25 18:23:16	2020/05/25 18:23:58	*****/**/****
C1891 Cooling fan low rev. (add axis)	R	2020/05/25 18:23:20	2020/05/25 18:23:29	*****/**/****
C2740 CMP error (coordinates conv.)	R	2020/05/25 18:23:34	2020/05/25 18:23:13	*****/**/****
C8060 The mode is not TEACH	R	2020/05/25 18:23:39	2020/05/25 18:23:52	*****/**/****
C8070 The time cannot be set	R	2020/05/25 18:23:41	2020/05/25 18:23:44	*****/**/****
C7000 Copy source file was not found	R	2020/05/25 18:23:46	2020/05/25 18:23:49	*****/**/****
C7020 Rename target file was not found	R	2020/05/25 18:23:51	2020/05/25 18:23:57	*****/**/****
C7121 Grease replenishment period (J1)	R	2020/05/25 18:23:59	2020/05/25 18:27:52	*****/**/****
C7181 Timing belt replacement period (J1)	R	2020/05/25 18:27:07	2020/05/25 18:27:10	*****/**/****
C7141 Overhaul period (decelerator) (J1)	R	2020/05/25 18:27:25	2020/05/25 18:27:28	*****/**/****
C7151 Overhaul period (bearing) (J1)	R	2020/05/25 18:48:01	2020/05/25 18:48:22	*****/**/****
C7153 Overhaul period (bearing) (J3)	R	2020/05/25 18:48:22	2020/05/25 18:48:45	*****/**/****
C7410 1 month inspection is now	R	2020/05/25 18:48:46	2020/05/25 18:49:01	*****/**/****

Operation history

Jump to the data having the same time stamp as the seek bar

Jump to the data having the same time stamp as the event

Support globalization

Speech synthesis function

Just enter arbitrary text in GT Works3 to create a sound file. It is easy to create a sound file of a message that is needed to output sound on GOT. The speaker (female/male), language, speed, pitch, and volume of the voice can be set. Messages can be created in 6 languages and you can create the sound notification system in multiple languages.

* To register or update messages, GT Works Text to Speech License (SW1DND-GTVO-M) is required.

Supported language

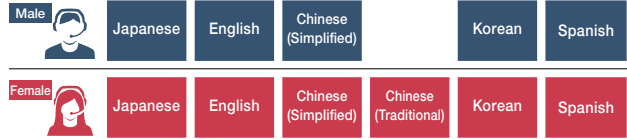
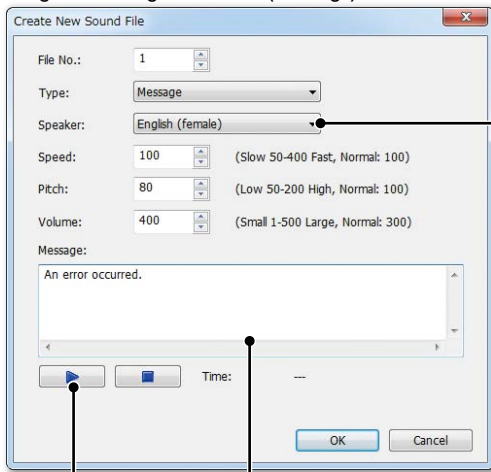

Image of creating a sound file (message)



Select language and speaker (male/female)

Playback and check the sound

Enter an arbitrary message



Procedure: [Common] → [Sound] → [Sound File List]

Language switching

Create comments of different languages, save them in separate columns, and you can switch languages easily just by switching column numbers. In addition, the character strings of switches and lamps can easily be converted from the Text or Text Figures into Comments. This makes it easy to upgrade screens to display multiple languages.

Comment group

Column No.	1 English	2 Japanese	3 Chinese
Windows Font	Arial	MS UI Gothic	MingLiU
Comment No. (DEC)	KANJI Region Japan	KANJI Region Japan	KANJI Region China (GB)-Mincho
1 Menu	メニュー	菜单	
2 Monitor	モニター	監視	
3 Diagnosis	診断	诊断	
4 Alarm	アラーム	报警	
5 Reset	リセット	复位	

Register text to comment group!

Add comments for language switching!



Text

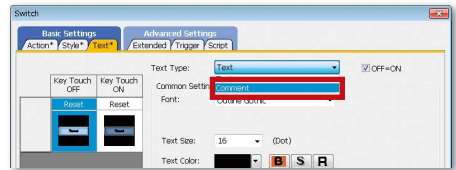

Text figure

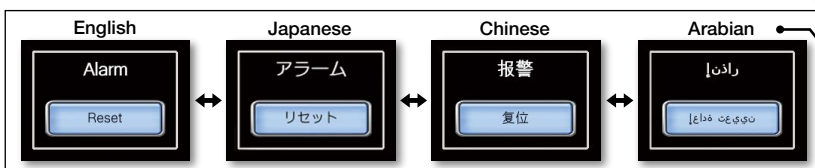
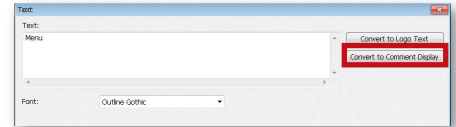

Various languages are supported because Windows fonts can be used for comment groups.

Comment group for easy language switching!

Procedure: [Common] → [GOT Environmental Setting] → [Language Switching]

Upgraded

FA Term Translation Tool

This is the software to translate comments (words, sentences) that are used in MELSOFT applications including GT Works3. The software uses the FA Term Translation Dictionary provided by Mitsubishi Electric. You can use the software even when your computer is not connected to the Internet. In addition, it is possible to create your own dictionary and switch dictionaries depending on your needs. The software supports creation of multiple language screens.

FA Term Translation Tool

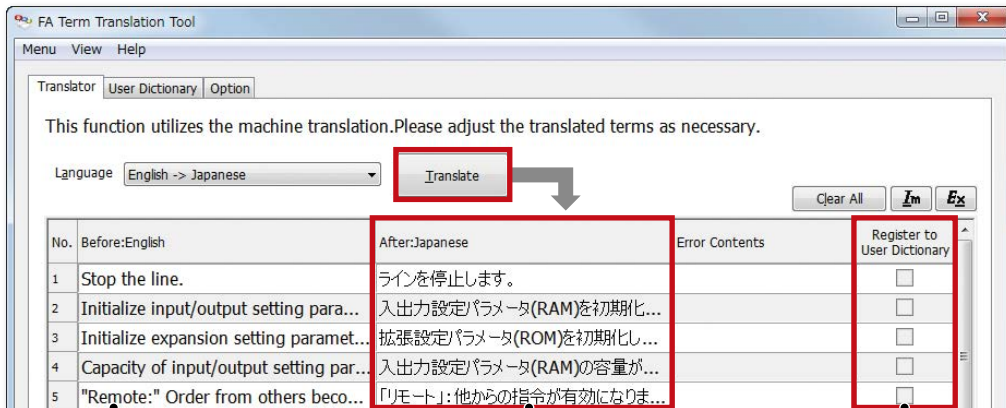

- 1 Copy comments to translate (e.g. from GT Works3) and paste them to the FA Term Translation Tool window
- 2 Translated results are displayed
- 3 Check a checkbox to save it to the dictionary

GT Works3

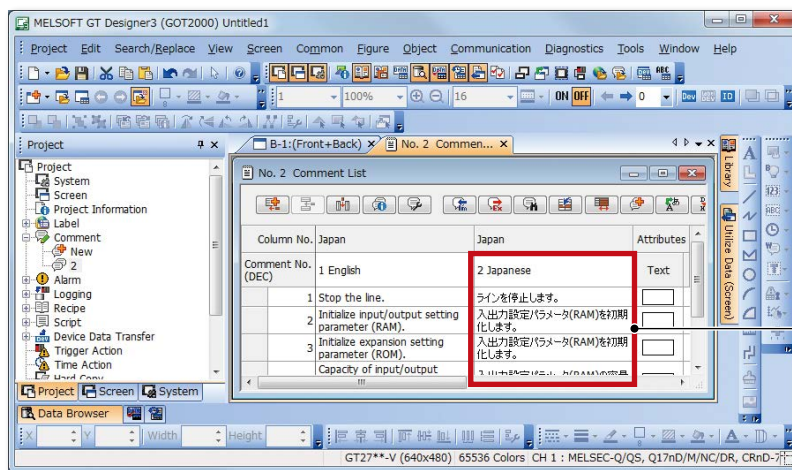

- 4 Copy the comments translated with FA Term Translation Tool and paste them to where you want to use them (e.g. GT Works3).
- 5 It is easy to create language switching screens.

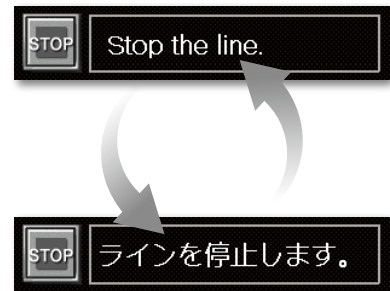

Starting FA Term Translation Tool

Procedure: Windows menu → [MELSOFT] → [ FA Term Translation Tool]

Specification details and restrictions

Compatible language

• Japanese → English, Chinese (Simplified), Chinese (Traditional), Korean **NEW**, Thai **NEW**

• English, Chinese (Simplified), Chinese (Traditional), Korean **NEW**, Thai **NEW** → Japanese

Supported OS (Japanese version, English version)

- Microsoft® Windows® 10
- Microsoft® Windows® 8.1

About this tool

Translation by FA Term Translation Tool is a mechanical translation. Use this tool as a tool to support translation.

How to obtain this tool

This tool is included in the MITSUBISHI ELECTRIC FA Library DVD-ROM of GT Works3 Version 1.130L or later.

For the details, please contact your local sales office.

e-F@ctory solves customers' issues and concerns by enabling visualization and analysis that lead to improvements and increase availability at shop floor.

e-F@ctory is the Mitsubishi Electric solution for improving the performance of any manufacturing enterprise by enhancing productivity, and reducing the maintenance and operations costs together with seamless information flow throughout the plant.

e-F@ctory helps to reduce the overall TCO* and is achieved in the following four areas:

* TCO: Total Cost of Ownership

Reduce energy costs

Energy saving solution

Modern manufacturing depends much on reducing energy costs as a way to realize an efficient manufacturing enterprise. e-F@ctory supports this by allowing visualization of real-time energy usage, helping to reduce the overall energy consumption.

Integrate FA and IT systems at low cost

Edge-computing (FA-IT information connection)

e-F@ctory solutions provide direct connectivity from the shop floor to enterprise, such as Manufacturing Execution System (MES) without requiring a gateway computer. This enables leaner operations, improved yield, and efficient management of the supply chain.

Reduce development, production, and maintenance costs

iQ Platform

The iQ Platform minimizes costs at all phases of the automation life cycle by improving development times, enhancing productivity, reducing maintenance costs, and making information more easily accessible. Integration is at the heart of the iQ Platform, with a highly intelligent controller platform as the core, combined with a seamless communication network and an integrated engineering environment.



Reduce setup and maintenance costs

iQ Sensor Solution

Easily setup and maintain various types of sensors. Maintenance and design costs can be reduced as compatible iQSS partner sensors can be managed together.



FA integrated solutions reduce total cost

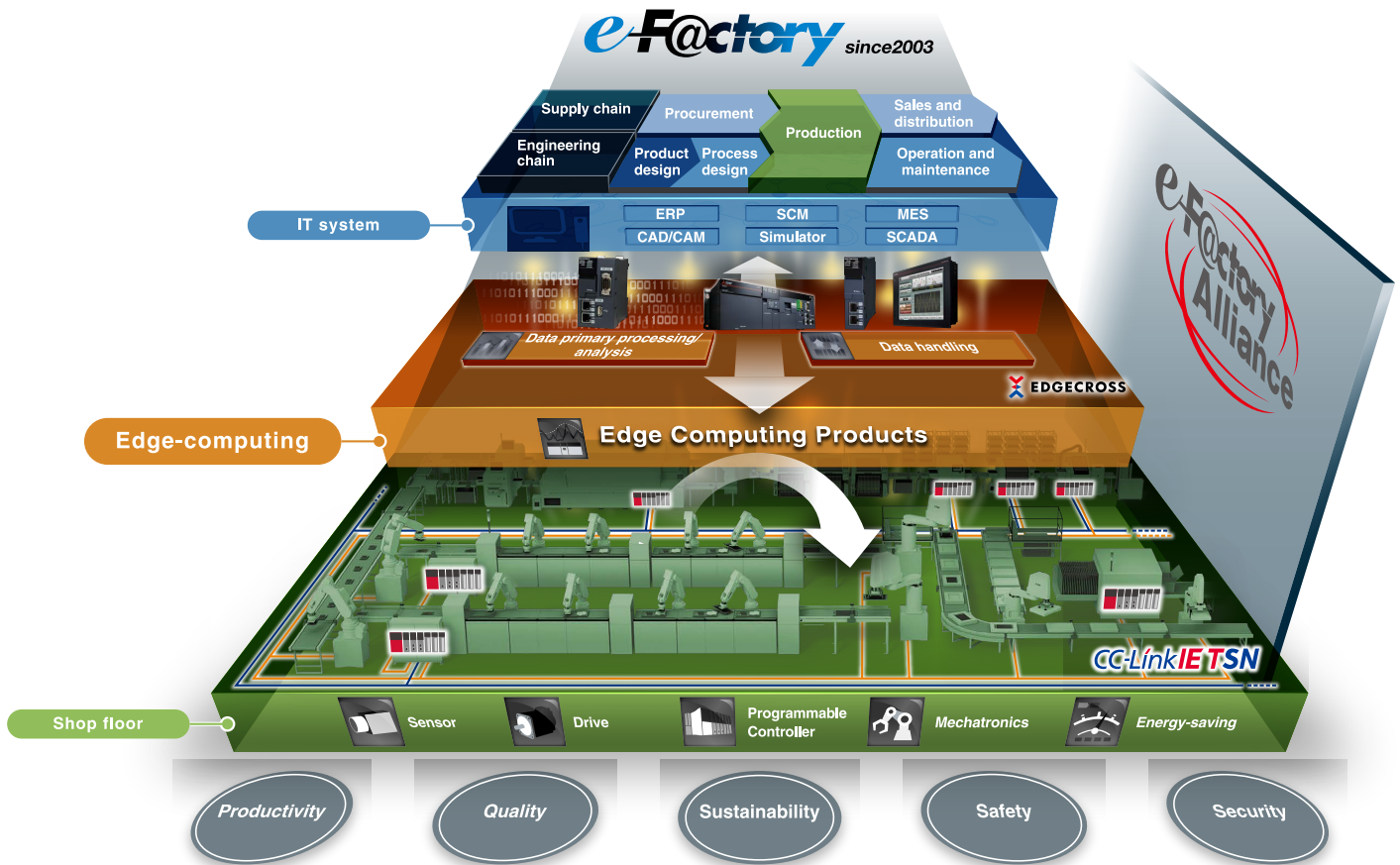

Overall production information is captured in addition to energy information, enabling the realization of efficient production and energy use (energy savings).

Best-in-class solutions across the ecosystem

e-F@ctory Alliance

The e-F@ctory Alliance is an ecosystem offering best-in-class solutions by combining products between Mitsubishi Electric and its various partners. Close collaboration with such partners broaden the choices for the customer and realize the best solution possible.



Related materials Various catalogs and leaflets are available.

■ Extensive lineup and solutions for various applications



GOT2000 Series Wide Model
L(NA)08461ENG

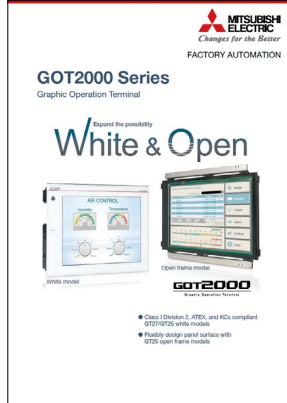

GOT2000 Series White & Open
L(NA)08414ENG



GOT2000 Series Rugged Model
L(NA)08555ENG

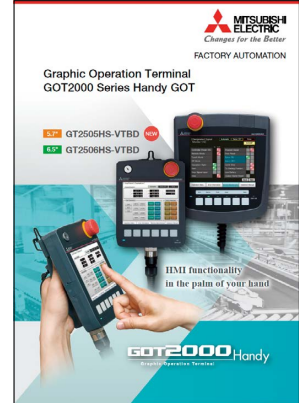

GOT2000 Series Handy GOT
L(NA)08506ENG

■ First Guide



GT SoftGOT2000 Solutions
L(NA)08606ENG



GOT2000 Series GOT Mobile Function
Application Examples
L(NA)08464ENG



FA Application Package
iQ Monozukuri Process Remote
Monitoring
L(NA)08674ENG

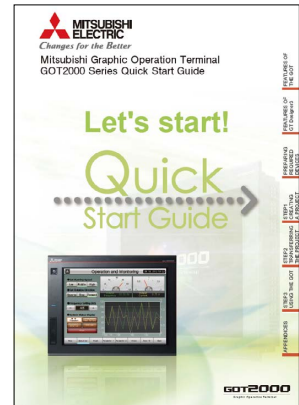

GOT2000 Series Quick Start Guide
L(NA)08311ENG

■ GOT SIMPLE Series catalogs

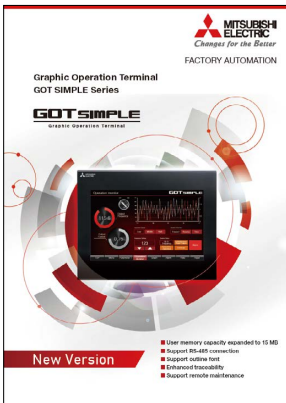

GOT SIMPLE Series*
L(NA)08649ENG (D700 Version)
L(NA)08676ENG (CS80 Version)



Simple Solution Catalog*
L(NA)08602ENG (D700 Version)
L(NA)08355ENG (CS80 Version)

■ ICONICS Automation Software Suite

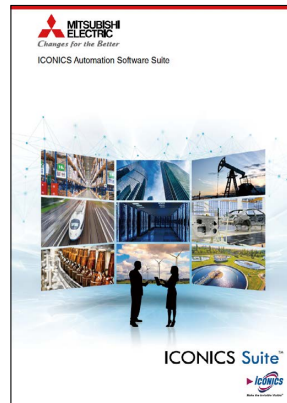

ICONICS Automation Software Suite
(L(NA)08785ENG)

* The inverter model in the catalog differs depending on the catalog number.

Specifications, Product List, Support INDEX

■ General specifications	
Performance specifications	
Power supply specifications	
GT27 model.....	142
GT25 model.....	144
GT25 wide model/GT25 handy GOT ...	146
GT25 rugged model.....	148
GT23 model.....	150
GT21 wide model/GT21 model	152
GS21 model.....	154
■ External dimensions	
Panel cut dimensions	
GT27 model/GT25 model	156
GT25 open frame model	157
GT25 wide model.....	158
GT25 handy GOT	158
GT25 rugged model.....	159
GT23 model.....	159
GT21 wide model.....	160
GT21 model.....	160
GS21 model.....	161
Communication cable.....	162
■ Operating environment	
MELSOFT GT Works3 Version1	164
GT SoftGOT2000 Version1	165
■ Function list	166
■ Connectable model list	
GOT2000/GOT SIMPLE	170
GT SoftGOT2000 Version1	187
■ Compatibility with conventional products	195
■ Product list	196
■ Support	
Global support	206
Approval standards	207
■ Related products	208

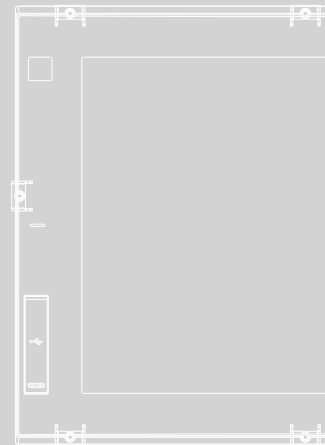

Specifications

GT27 model

General specifications

Item	Specifications						
Operating ambient temperature *1	0 °C to 55 °C *2	*1 Includes the temperature inside the enclosure of the control panel to which the GOT is installed.					
Storage ambient temperature	-20 °C to 60 °C	*2 When any of the following units or option is mounted, the maximum operating ambient temperature must be 5 °C lower than the one described in the general specifications: multimedia unit (GT27-MMR-Z), MELSECNET/H communication unit (GT15-J71LP23-25, GT15-J71BR13), CC-Link communication unit (GT15-J61BT13), protective cover for oil.					
Operating ambient humidity	10% RH to 90% RH, non-condensing						
Storage ambient humidity	10% RH to 90% RH, non-condensing						
Vibration resistance	Compliant with JIS B 3502 and IEC 61131-2 *7	Frequency	Acceleration	Half amplitude	Sweep count	10 times in each X, Y, or Z direction	
		Under intermittent vibration	5 to 8.4 Hz	—	3.5 mm		—
			8.4 to 150 Hz	9.8 m/s ²	—		
		Under continuous vibration	5 to 8.4 Hz	—	1.75 mm		—
	8.4 to 150 Hz	4.9 m/s ²	—				
Shock resistance	Compliant with JIS B 3502 and IEC 61131-2 (147 m/s ² (15G), 3 times in each X, Y, or Z direction)						
Operating atmosphere *6	No greasy fumes, corrosive gas, flammable gas, excessive conductive dust, and direct sunlight (as well as at storage)						
Operating altitude *3	2000 m or less						
Installation location	Inside control panel						
Overvoltage category *4	II or less						
Pollution degree *5	2 or less						
Cooling method	Self-cooling						
Grounding	Grounding with a ground resistance of 100 Ω or less by using a ground cable that has a cross-sectional area of 2 mm ² or more. If impossible, connect the ground cable to the control panel.						
Operate and store the GOT in environments without direct sunlight, high temperature, dust, humidity, and vibrations.							
For the status of conforming to various standards and laws (CE, UKCA, ATEX, UL/cUL, Class I Division 2, KC, KCs, and maritime certifications [ABS/BV/DNV/LR/NK/RINA]), please contact your local sales office.							

Performance specifications

Item	Specifications			
	GT2715-XTBA GT2715-XTBD	GT2712-STBA GT2712-STBD	GT2712-STWA GT2712-STWD	GT2710-STBA GT2710-STBD
Display section *1 *2	TFT color LCD			
	Display device	15"		
	Screen size	12.1"		
	Resolution	XGA: 1024 × 768 dots		
	Resolution	SVGA: 800 × 600 dots		
	Display size	304.1(11.97) (W) × 228.1(8.98) (H) mm(inch)	246(9.69) (W) × 184.5(7.26) (H) mm(inch)	211.2(8.31) (W) × 158.4(6.24) (H) mm(inch)
	Number of displayed characters	16-dot standard font: 64 characters × 48 lines (two-byte characters) 12-dot standard font: 85 characters × 64 lines (two-byte characters)	16-dot standard font: 50 characters × 37 lines (two-byte characters) 12-dot standard font: 66 characters × 50 lines (two-byte characters)	
	Display color	65536 colors		
	Brightness adjustment	32 levels		
	Backlight	LED (not replaceable)		
Backlight life *4	Approx. 60000 h (operating ambient temperature: 25 °C, display intensity: 50%)			
Touch panel *3 *11	Type	Analog resistive film		
	Key size	Minimum 2 × 2 dots *9 (per key)		
	Simultaneous press	Up to two points		
	Life	1 million touches or more (operating force: 0.98 N or less)		
Panel color	Black	White	Black	
Human sensor	Detection length	1 m		
	Detection temperature	Temperature difference between human body and ambient air: 4 °C or higher		
User memory	User memory capacity	Memory for storage (ROM) *12: 57 MB Memory for operation (RAM): 256 MB *13		
	Life (number of write times)	100000 times		
Built-in clock precision	±90 seconds/month (ambient temperature: 25 °C)			
Battery	Data to be backed up	SRAM data, clock data, system status log data		
	Life	Approx. 5 years (ambient temperature: 25 °C)		
Built-in interface	RS-232	1 channel Transmission speed: 115200, 57600, 38400, 19200, 9600, 4800 bps Connector shape: D-sub 9-pin (male)		
	RS-422/485	1 channel Transmission speed: 115200, 57600, 38400, 19200, 9600, 4800 bps Connector shape: D-sub 9-pin (female)		
	Ethernet	1 channel Data transfer method: 100BASE-TX, 10BASE-T Connector shape: RJ45 (modular jack) AUTO MDI/MDI-X		
	USB (host)	2 channels (front face, rear face)	1 channel (rear face)	2 channels (front face, rear face)
	USB (device)	1 channel (front face)	1 channel (rear face)	1 channel (front face)
	SD memory card *12	USB version: USB 2.0 (High-Speed 480 Mbps), Connector shape: USB Mini-B 1 channel, SDHC compliant (maximum 32 GB)		
	Extension interface *7	For installing a communication unit or an option unit		
	Auxiliary extension interface	For installing an option unit		
Side interface	For installing a communication unit			
Buzzer output	Single tone (tone and tone length adjustable)			
POWER LED	2 colors (blue and orange)			
Protective structure *5	Front: IP67F *6 *9 Inside control panel: IP2X			
Safety standards, radio laws (as of June 2023)	CE, UKCA, UL, cUL, KC		CE, UKCA, ATEX *10, UL, cUL, Class I Division 2, KC, KCs *10	CE, UKCA, UL, cUL, KC
External dimensions	397(15.63) (W) × 300(11.81) (H) × 60(2.36) (D) mm(inch)	316(12.44) (W) × 246(9.69) (H) × 52(2.05) (D) mm(inch)	303(11.93) (W) × 218(8.58) (H) × 52(2.05) (D) mm(inch)	
Panel cut dimensions	383.5(15.10) (W) × 282.5(11.12) (H) mm(inch)	302(11.89) (W) × 228(8.98) (H) mm(inch)	289(11.38) (W) × 200(7.87) (H) mm(inch)	
Weight (excluding a fitting)	4.5(9.9) kg(lb)	2.4(5.3) kg(lb)	2.1(4.6) kg(lb)	
Compatible software package	GT Works3 Version 1.270G or later			

*1 As a characteristic of liquid crystal display panels, bright dots (always lit) and dark dots (never lit) may appear on the panel. Since liquid crystal display panels comprise a great number of display elements, the appearance of bright and dark dots cannot be reduced to zero. Individual differences in liquid crystal display panels may cause differences in color, uneven brightness and flickering. Note that these phenomena are characteristics of liquid crystal display panels and it does not mean the products are defective or damaged.

*2 Flickering may occur due to vibration, shock, or the display colors.

*3 When a stylus is used, the touch panel has a life of 100 thousand touches. The stylus must satisfy the following specifications.
• Material: polyacetal resin • Tip radius: 0.8 mm or more

*4 To prevent the display section from burning in and lengthen the backlight life, enable the screen save function and turn off the backlight.

*5 Note that the structure does not guarantee protection in all users' environments. The GOT may not be used in certain environments where it is subjected to splashing oil or chemicals for a long period of time or soaked in oil mist.

Power supply specifications

Item	Specifications									
	GT2715-XTBA	GT2712-STBA GT2712-STWA	GT2710-STBA GT2710-VTBA GT2710-VTWA	GT2708-STBA GT2708-VTBA	GT2715-XTBD	GT2712-STBD GT2712-STWD	GT2710-STBD GT2710-VTBD GT2710-VTWD	GT2708-STBD GT2708-VTBD	GT2705-VTBD	
Power supply voltage	100 V AC to 240 V AC (+10%, -15%)				24 V DC (+25%, -20%)					
Power supply frequency	50 Hz/60 Hz (±5%)				-					
Power consumption	Under the maximum load	51 W or less	44 W or less	41 W or less	41 W or less	48 W or less	45 W or less	42 W or less	39 W or less	30 W or less
	Main unit	25 W	19 W	17 W	15 W	23 W	18 W	15 W	13 W	7 W
	Main unit (backlight OFF)	10 W	10 W	10 W	10 W	8 W	8 W	8 W	8 W	5 W
Inrush current	40 A or less (3 ms, ambient temperature: 25 °C, under the maximum load)		60 A or less (2 ms, ambient temperature: 25 °C, under the maximum load)		5 A or less (20 ms, ambient temperature: 25 °C, under the maximum load)			69 A or less (1 ms, ambient temperature: 25 °C, under the maximum load)		
Permissible instantaneous power failure time	20 ms or less (100 V AC or more)				10 ms or less					
Noise immunity	Noise voltage: 1500 Vp-p, noise width: 1 μs, measured by a noise simulator with noise frequency ranging from 25 Hz to 60 Hz				Noise voltage: 500 Vp-p, noise width: 1 μs, measured by a noise simulator with noise frequency ranging from 25 Hz to 60 Hz					
Withstand voltage	1500 V AC for 1 minute across power terminals and earth				350 V AC for 1 minute across power terminals and earth					
Insulation resistance	500 V DC across power terminals and earth, 10 MΩ or more by an insulation resistance tester									

Item	Specifications				
	GT2710-VTBA GT2710-VTBD	GT2710-VTWA GT2710-VTWD	GT2708-STBA GT2708-STBD	GT2708-VTBA GT2708-VTBD	GT2705-VTBD
Display section *1 *2	TFT color LCD				
	10.4"		8.4"		5.7"
	VGA: 640 x 480 dots		SVGA: 800 x 600 dots		VGA: 640 x 480 dots
	211.2(8.31) (W) x 158.4(6.24) (H) mm(inch)		170.9(6.73) (W) x 128.2(5.05) (H) mm(inch)		115.2(4.54) (W) x 86.4(3.40) (H) mm(inch)
	16-dot standard font: 40 characters x 30 lines (two-byte characters)		16-dot standard font: 50 characters x 37 lines (two-byte characters)		16-dot standard font: 40 characters x 30 lines (two-byte characters)
	12-dot standard font: 53 characters x 40 lines (two-byte characters)		12-dot standard font: 66 characters x 50 lines (two-byte characters)		12-dot standard font: 53 characters x 40 lines (two-byte characters)
	65536 colors				
	32 levels				
	LED (not replaceable)				
	Approx. 60000 h (operating ambient temperature: 25 °C, display intensity: 50%)				
Touch panel *3 *11	Analog resistive film				
	Minimum 2 x 2 dots ¹⁹ (per key)				
	Up to two points				
	1 million touches or more (operating force: 0.98 N or less)				
Panel color	Black	White	Black		
Human sensor	-				
	-				
User memory	Memory for storage (ROM) ¹² : 57 MB				Memory for storage (ROM) ¹² : 32 MB
	Memory for operation (RAM): 256 MB ¹³				Memory for operation (RAM): 80 MB
100000 times					
±90 seconds/month (ambient temperature: 25 °C)					
GT11-50BAT lithium battery					
Battery	SRAM data, clock data, system status log data				
	Approx. 5 years (ambient temperature: 25 °C)				
Built-in interface	RS-232 1 channel Transmission speed: 115200, 57600, 38400, 19200, 9600, 4800 bps Connector shape: D-sub 9-pin (male)				
	RS-422/485 1 channel Transmission speed: 115200, 57600, 38400, 19200, 9600, 4800 bps Connector shape: D-sub 9-pin (female)				
	Ethernet 1 channel Data transfer method: 100BASE-TX, 10BASE-T Connector shape: RJ45 (modular jack) AUTO MDI/MDI-X				
	2 channels (front face, rear face)		1 channel (rear face)	2 channels (front face, rear face)	
	USB version: USB 2.0 (High-Speed 480 Mbps), Connector shape: USB-A				
	1 channel (front face)		1 channel (rear face)	1 channel (front face)	
	USB version: USB 2.0 (High-Speed 480 Mbps), Connector shape: USB Mini-B				
	1 channel, SDHC compliant (maximum 32 GB)				
	For installing a communication unit or an option unit				
	For installing an option unit				
-					
For installing a communication unit					
Buzzer output	Single tone (tone and tone length adjustable)				
POWER LED	2 colors (blue and orange)				
Protective structure ¹⁵	Front: IP67F ¹⁶ Inside control panel: IP2X				
Safety standards, radio laws (as of June 2023)	CE, UKCA, UL, cUL, KC		CE, UKCA, ATEX ¹⁰ , UL, cUL, Class I Division 2, KC, KCs ¹⁰		CE, UKCA, UL, cUL, KC
External dimensions	303(11.93) (W) x 218(8.58) (H) x 52(2.05) (D) mm(inch)		241(9.49) (W) x 194(7.64) (H) x 52(2.05) (D) mm(inch)		167(6.57) (W) x 139(5.47) (H) x 60(2.36) (D) mm(inch)
Panel cut dimensions	289(11.38) (W) x 200(7.87) (H) mm(inch)		227(8.94) (W) x 176(6.93) (H) mm(inch)		153(6.02) (W) x 121(4.76) (H) mm(inch)
Weight (excluding a fitting)	2.1(4.6) kg(lb)		1.5(3.3) kg(lb)		1.0(2.2) kg(lb)
Compatible software package	GT Works3 Version 1.270G or later				

¹⁶ To conform to IP67F, close the USB environmental protection cover by pushing the [PUSH] mark firmly. (The GOT conforms to IP2X when the USB environmental protection cover is open.)

¹⁷ When using a GT2705-VTBD with multiple devices such as extension units, a barcode reader, and an RFID controller, the total amount of current must be within the maximum amount of current supplied by the GT2705-VTBD. For the details, please refer to the relevant manual of the GOT2000 Series.

¹⁸ The minimum size of a key that can be arranged. To ensure safe use of the product, the following settings are recommended.
 • Key size: 16 x 16 dots or larger • Distance between keys: 16 dots or more

¹⁹ The suffix "F" of IP67F is a symbol that indicates protection rate against oil. It is described in the Appendix of Japanese Industrial Standard JIS C 0920.

¹⁰ ATEX and KCs are supported by GT2712-STWD and GT2710-VTWD (24 V DC power supply type) only.

¹¹ Repeatedly touching the outer edge of the actual display area may cause the product to fail.

¹² While writing data to the memory for storage (ROM) or an SD memory card, if GOT is powered off, the data may be corrupted which may cause the GOT to stop operating.

¹³ If the function version is B or earlier, the memory for operation (RAM) is 128 MB.

Specifications

GT25 model

* For the specifications of GT25 wide models, GT25 handy GOT, and GT25 rugged model, please refer to pages 146 to 149.

General specifications

Item	Specifications				
Operating ambient temperature *1	0 °C to 55 °C *2 *7				
Storage ambient temperature	-20 °C to 60 °C				
Operating ambient humidity	10% RH to 90% RH, non-condensing *8				
Storage ambient humidity	10% RH to 90% RH, non-condensing *8				
Vibration resistance	Compliant with JIS B 3502 and IEC 61131-2 *9				
	Under intermittent vibration	Frequency 5 to 8.4 Hz 8.4 to 150 Hz	Acceleration — 9.8 m/s ²	Half amplitude 3.5 mm —	Sweep count 10 times in each X, Y, or Z direction —
	Under continuous vibration	Frequency 5 to 8.4 Hz 8.4 to 150 Hz	Acceleration — 4.9 m/s ²	Half amplitude 1.75 mm —	—
	Compliant with JIS B 3502 and IEC 61131-2 (147 m/s ² (15G), 3 times in each X, Y, or Z direction)				
Shock resistance	Compliant with JIS B 3502 and IEC 61131-2 (147 m/s ² (15G), 3 times in each X, Y, or Z direction)				
Operating atmosphere *6	No greasy fumes, corrosive gas, flammable gas, excessive conductive dust, and direct sunlight (as well as at storage)				
Operating altitude *3	2000 m or less				
Installation location	Inside control panel				
Overvoltage category *4	II or less				
Pollution degree *5	2 or less				
Cooling method	Self-cooling				
Grounding	Grounding with a ground resistance of 100 Ω or less by using a ground cable that has a cross-sectional area of 2 mm ² or more. If impossible, connect the ground cable to the control panel.				

- *1 Includes the temperature inside the enclosure of the control panel to which the GOT is installed.
- *2 When any of the following units or option is mounted, the maximum operating ambient temperature must be 5°C lower than the one described in the general specifications: MELSECNET/H communication unit (GT15-J71LP23-25, GT15-J71BR13), CC-Link communication unit (GT15-J61BT13), protective cover for oil.
- *3 Do not use or store the GOT under a pressure higher than the atmospheric pressure at altitude 0 m. Doing so may cause a malfunction. Air purging by applying pressure to the control panel may create clearance between the surface sheet and the touch panel. This may cause the touch panel to be not sensitive enough or the sheet to come off.
- *4 This indicates the section of the power supply to which the equipment is assumed to be connected between the public electrical power distribution network and the machinery within the premises. Category II applies to equipment that is supplied with power from fixed facilities. The withstand surge voltage for the equipment with the rated voltage up to 300 V is 2500 V.
- *5 This indicates the occurrence rate of conductive material in an environment where a device is used. Pollution degree 2 indicates an environment where only non-conductive pollution occurs normally and a temporary conductivity caused by condensation shall be expected depending on the conditions.
- *6 Some models have ANSI/ISA 12.12.01 approval for use in Class I, Division 2 (ANSI/ISA 12.12.01, C22.2 No.213-M1987) hazardous locations. For applicable GOT models, please contact your local sales office.
- *7 When GT2505-VTBD is installed vertically, the operating ambient temperature must be between 0 °C and 50 °C.
- *8 If the ambient temperature of GT2505-VTBD exceeds 40 °C, the absolute humidity must not exceed 90% RH at 40 °C.
- *9 The definition of 1 G has been changed from 9.8 m/s² to 10 m/s² in JIS B 3502:2021 and IEC 61131-2 ED.3. The product was tested by using the former definition, 1 G = 9.8 m/s².

Operate and store the GOT in environments without direct sunlight, high temperature, dust, humidity, and vibrations.

For the status of conforming to various standards and laws (CE, UKCA, ATEX, UL/cUL, Class I Division 2, KC, KCs, and maritime certifications [ABS/DNV/LR/NK/RINA]), please contact your local sales office.

Performance specifications

Item	Specifications				
	GT2512-STBA GT2512-STBD	GT2512F-STNA GT2512F-STND	GT2510-VTBA GT2510-VTBD	GT2510-VTWA GT2510-VTWD	GT2510F-VTNA GT2510F-VTND
Display section *1 *2	Display device				
	TFT color LCD				
	Screen size		12.1"		
	Resolution		10.4"		
	Resolution		SVGA: 800 × 600 dots		
	Display size		VGA: 640 × 480 dots		
	Display size		246(9.69) (W) × 184.5(7.26) (H) mm(inch)		
	Display size		211.2(8.31) (W) × 158.4(6.24) (H) mm(inch)		
	Number of displayed characters		16-dot standard font: 50 characters × 37 lines (two-byte characters)		
	Number of displayed characters		12-dot standard font: 66 characters × 50 lines (two-byte characters)		
Number of displayed characters		16-dot standard font: 40 characters × 30 lines (two-byte characters)			
Number of displayed characters		12-dot standard font: 53 characters × 40 lines (two-byte characters)			
Display color		65536 colors			
Brightness adjustment		32 levels			
Backlight		LED (not replaceable)			
Backlight life *4		Approx. 60000 h (operating ambient temperature: 25 °C, display intensity: 50%)			
Touch panel *3 *12	Type				
	Analog resistive film				
	Key size				
	Minimum 2 × 2 dots *9 (per key)				
Simultaneous press					
Not available *5 (Only 1 point can be touched.)					
Life					
1 million touches or more (operating force: 0.98 N or less)					
Panel color		Black	—	Black	White
User memory		Memory for storage (ROM) *13: 32 MB			
Life (number of write times)		Memory for operation (RAM): 80 MB			
Built-in clock precision		100000 times			
Battery		±90 seconds/month (ambient temperature: 25 °C)			
Data to be backed up		GT11-50BAT lithium battery			
Life		SRAM data, clock data, system status log data			
Life		Approx. 5 years (ambient temperature: 25 °C)			
Built-in interface	RS-232				
	1 channel Transmission speed: 115200, 57600, 38400, 19200, 9600, 4800 bps Connector shape: D-sub 9-pin (male)				
	RS-422/485				
	1 channel Transmission speed: 115200, 57600, 38400, 19200, 9600, 4800 bps Connector shape: D-sub 9-pin (female)				
	Ethernet				
	1 channel Data transfer method: 100BASE-TX, 10BASE-T Connector shape: RJ45 (modular jack) AUTO MDI/MDI-X				
	USB (host)				
	2 channels (front face, rear face) 1 channel (rear face) 2 channels (front face, rear face) 1 channel (rear face)				
USB (device)					
USB version: USB 2.0 (High-Speed 480 Mbps), Connector shape: USB-A					
1 channel (front face) 1 channel (rear face) 1 channel (front face) 1 channel (rear face)					
SD memory card *13					
1 channel, SDHC compliant (maximum 32 GB)					
Extension interface					
For installing a communication unit or an option unit					
Side interface					
For installing a communication unit					
Buzzer output		Single tone (tone and tone length adjustable)			
POWER LED		2 colors (blue and orange)			
Protective structure *6		Front: IP67F *7 *10 Inside control panel: IP2X	Front: IP67F *8 *10 Inside control panel: IP2X	Front: IP67F *7 *10 Inside control panel: IP2X	Front: IP67F *10 Inside control panel: IP2X
Safety standards, radio laws (as of June 2023)		CE, UKCA, UL, cUL, KC			CE, UKCA, ATEX *11, UL, cUL, Class I Division 2, KC, KCs *11
External dimensions		316(12.44) (W) × 246(9.69) (H) × 52(2.05) (D) mm(inch)	311(12.24) (W) × 237(9.33) (H) × 54(2.13) (D) mm(inch)	303(11.93) (W) × 218(8.58) (H) × 52(2.05) (D) mm(inch)	298(11.73) (W) × 209(8.23) (H) × 54(2.13) (D) mm(inch)
Panel cut dimensions		302(11.89) (W) × 228(8.98) (H) mm(inch)	269(10.59) (W) × 214(8.43) (H) mm(inch)	289(11.38) (W) × 200(7.87) (H) mm(inch)	234(9.21) (W) × 187(7.36) (H) mm(inch)
Weight (excluding a fitting)		2.4(5.3) kg(lb)			2.1(4.6) kg(lb)
Compatible software package		GT Works3 Version 1.270G or later			

- *1 As a characteristic of liquid crystal display panels, bright dots (always lit) and dark dots (never lit) may appear on the panel. Since liquid crystal display panels comprise a great number of display elements, the appearance of bright and dark dots cannot be reduced to zero. Individual differences in liquid crystal display panels may cause differences in color, uneven brightness and flickering. Note that these phenomena are characteristics of liquid crystal display panels and it does not mean the products are defective or damaged.
- *2 Flickering may occur due to vibration, shock, or the display colors.
- *3 When a stylus is used, the touch panel has a life of 100 thousand touches. The stylus must satisfy the following specifications.
• Material: polyacetal resin • Tip radius: 0.8 mm or more
- *4 To prevent the display section from burning in and lengthen the backlight life, enable the screen save function and turn off the backlight.
- *5 If you touch two points or more simultaneously on the touch panel, a switch in an unintended location may operate. Do not touch two points or more simultaneously on the touch panel.
- *6 Note that the structure does not guarantee protection in all users' environments. The GOT may not be used in certain environments where it is subjected to splashing oil or chemicals for a long period of time or soaked in oil mist.

Power supply specifications

Item	Specifications						
	GT2512-STBA GT2512F-STNA	GT2510-VTBA GT2510F-VTNA	GT2508-VTBA GT2508F-VTNA	GT2512-STBD GT2512F-STND	GT2510-VTBD GT2510F-VTND	GT2508-VTBD GT2508F-VTND	GT2505-VTBD
Power supply voltage	100 V AC to 240 V AC (+10%, -15%)			24 V DC (+25%, -20%)			24 V DC (+10%, -15%)
Power supply frequency	50 Hz/60 Hz (±5%)			—			—
Power consumption	Under the maximum load	35 W or less	34 W or less	31 W or less	37 W or less	33 W or less	31 W or less
	Main unit	14 W	12 W	11 W	13 W	10 W	8 W
	Main unit (backlight OFF)	7 W	7 W	7 W	6 W	6 W	6 W
Inrush current	60 A or less (2 ms, ambient temperature: 25 °C, under the maximum load)			5 A or less (20 ms, ambient temperature: 25 °C, under the maximum load)			42 A or less (2 ms, ambient temperature: 25 °C, under the maximum load)
Permissible instantaneous power failure time	20 ms or less (100 V AC or more)			10 ms or less			—
Noise immunity	Noise voltage: 1500 Vp-p, noise width: 1 μs, measured by a noise simulator with noise frequency ranging from 25 Hz to 60 Hz			Noise voltage: 500 Vp-p, noise width: 1 μs, measured by a noise simulator with noise frequency ranging from 25 Hz to 60 Hz			Noise voltage: 1000 Vp-p, noise width: 1 μs, measured by a noise simulator with noise frequency ranging from 30 Hz to 100 Hz
Withstand voltage	1500 V AC for 1 minute across power terminals and earth			350 V AC for 1 minute across power terminals and earth			500 V AC for 1 minute across power terminals and earth
Insulation resistance	500 V DC across power terminals and earth, 10 MΩ or more by an insulation resistance tester						

Item	Specifications			
	GT2508-VTBA GT2508-VTBD	GT2508-VTWA GT2508-VTWD	GT2508F-VTNA GT2508F-VTND	GT2505-VTBD
Display section *1 *2	Display device	TFT color LCD		
	Screen size	8.4"		5.7"
	Resolution	VGA: 640 × 480 dots		
	Display size	170.9(6.73) (W) × 128.2(5.05) (H) mm(inch)		115.2(4.54) (W) × 86.4(3.40) (H) mm(inch)
	Number of displayed characters	16-dot standard font: 40 characters × 30 lines (two-byte characters) 12-dot standard font: 53 characters × 40 lines (two-byte characters)		
	Display color	65536 colors		
	Brightness adjustment	32 levels		
	Backlight	LED (not replaceable)		
Backlight life *4	Approx. 60000 h (operating ambient temperature: 25 °C, display intensity: 50%)			
Touch panel *3 *12	Type	Analog resistive film		
	Key size	Minimum 2 × 2 dots *9 (per key)		
	Simultaneous press	Not available *5 (Only 1 point can be touched.)		
	Life	1 million touches or more (operating force: 0.98 N or less)		
Panel color	Black	White	—	Black
User memory	User memory capacity	Memory for storage (ROM) *13: 32 MB Memory for operation (RAM): 80 MB		
	Life (number of write times)	100000 times		
Built-in clock precision	±90 seconds/month (ambient temperature: 25 °C)			
Battery	Data to be backed up	GT11-50BAT lithium battery SRAM data, clock data, system status log data		
	Life	Approx. 5 years (ambient temperature: 25 °C)		
Built-in interface	RS-232	1 channel Transmission speed: 115200, 57600, 38400, 19200, 9600, 4800 bps Connector shape: D-sub 9-pin (male)		
	RS-422/485	1 channel Transmission speed: 115200, 57600, 38400, 19200, 9600, 4800 bps Connector shape: D-sub 9-pin (female)		
	Ethernet	1 channel Data transfer method: 100BASE-TX, 10BASE-T Connector shape: RJ45 (modular jack) AUTO MDI/MDI-X		
	USB (host)	2 channels (front face, rear face)	1 channel (rear face)	1 channel (rear face)
	USB (device)	1 channel (front face)	1 channel (rear face)	1 channel (front face)
	SD memory card *13	USB version: USB 2.0 (High-Speed 480 Mbps), Connector shape: USB Mini-B 1 channel, SDHC compliant (maximum 32 GB)		
	Extension interface	For installing a communication unit or an option unit		
Side interface	For installing a communication unit			
Buzzer output	Single tone (tone and tone length adjustable)			
POWER LED	2 colors (blue and orange)			
Protective structure *6	Front: IP67F *7 *10 Inside control panel: IP2X	Front: IP67F *10 Inside control panel: IP2X	Front: IP67F *8 *10 Inside control panel: IP2X	Front: IP67F *7 *10 Inside control panel: IP2X
Safety standards, radio laws (as of June 2023)	CE, UKCA, UL, cUL, KC	CE, UKCA, ATEX *11, UL, cUL, Class I Division 2, KC, KCs *11	CE, UKCA, UL, cUL, KC	
External dimensions	241(9.49) (W) × 194(7.64) (H) × 52(2.05) (D) mm(inch)		236(9.29) (W) × 185(7.28) (H) × 54(2.13) (D) mm(inch)	164(6.46) (W) × 139(5.47) (H) × 53.5(2.11) (D) mm(inch)
Panel cut dimensions	227(8.94) (W) × 176(6.93) (H) mm(inch)		194(7.64) (W) × 158(6.22) (H) mm(inch)	153(6.02) (W) × 121(4.76) (H) mm(inch)
Weight (excluding a fitting)	1.5(3.3) kg(lb)		—	0.6(1.3) kg(lb)
Compatible software package	GT Works3 Version 1.270G or later			

*7 To conform to IP67F, close the USB environmental protection cover by pushing the [PUSH] mark or the USB mark firmly. (The GOT conforms to IP2X when the USB environmental protection cover is open.)

*8 To conform to IP67F attach the environmental protection sheet.

*9 The minimum size of a key that can be arranged. To ensure safe use of the product, the following settings are recommended.
• Key size: 16 × 16 dots or larger • Distance between keys: 16 dots or more

*10 The suffix "F" of IP67F is a symbol that indicates protection rate against oil. It is described in the Appendix of Japanese Industrial Standard JIS C 0920.

*11 ATEX and KCs are supported by GT2510-VTWD and GT2508-VTWD (24 V DC power supply type) only.

*12 Repeatedly touching the outer edge of the actual display area may cause the product to fail.

*13 While writing data to the memory for storage (ROM) or an SD memory card, if GOT is powered off, the data may be corrupted which may cause the GOT to stop operating.

Specifications

GT25 wide model/GT25 handy GOT

General specifications

Item	Specifications					
	GT25 wide model		GT25 handy GOT			
Operating ambient temperature *1	0 °C to 55 °C *5		0 °C to 40 °C			
Storage ambient temperature	-20 °C to 60 °C					
Operating ambient humidity	10% RH to 90% RH, non-condensing					
Storage ambient humidity	10% RH to 90% RH, non-condensing					
Vibration resistance	Compliant with JIS B 3502 and IEC 61131-2 *6		Frequency	Acceleration	Half amplitude	Sweep count
		Under intermittent vibration	5 to 8.4 Hz	—	3.5 mm	10 times in each X, Y, or Z direction
			8.4 to 150 Hz	9.8 m/s ²	—	
		Under continuous vibration	5 to 8.4 Hz	—	1.75 mm	—
8.4 to 150 Hz	4.9 m/s ²		—			
Shock resistance	Compliant with JIS B 3502 and IEC 61131-2 (147 m/s ² (15G), 3 times in each X, Y, or Z direction)					
Operating atmosphere	No greasy fumes, corrosive gas, flammable gas, excessive conductive dust, and direct sunlight (as well as at storage)					
Operating altitude *2	2000 m or less					
Installation location	Inside control panel		—			
Overvoltage category *3	II or less					
Pollution degree *4	2 or less					
Cooling method	Self-cooling					
Grounding	Grounding with a ground resistance of 100 Ω or less by using a ground cable that has a cross-sectional area of 2 mm ² or more. If impossible, connect the ground cable to the control panel.					

- *1 Includes the temperature inside the enclosure of the control panel to which the GOT is installed. (GT25 wide model)
- *2 Do not use or store the GOT under a pressure higher than the atmospheric pressure at altitude 0 m. Doing so may cause a malfunction. Air purging by applying pressure to the control panel may create clearance between the surface sheet and the touch panel. This may cause the touch panel to be not sensitive enough or the sheet to come off.
- *3 This indicates the section of the power supply to which the equipment is assumed to be connected between the public electrical power distribution network and the machinery within the premises. Category II applies to equipment that is supplied with power from fixed facilities. The withstand surge voltage for the equipment with the rated voltage up to 300 V is 2500 V.
- *4 This indicates the occurrence rate of conductive material in an environment where a device is used. Pollution degree 2 indicates an environment where only non-conductive pollution occurs normally and a temporary conductivity caused by condensation shall be expected depending on the conditions.
- *5 When a protective cover for oil is mounted on the GOT, the maximum operating ambient temperature must be 5°C lower than the one described in the general specifications.
- *6 The definition of 1 G has been changed from 9.8 m/s² to 10 m/s² in JIS B 3502:2021 and IEC 61131-2 ED.3. The product was tested by using the former definition, 1 G = 9.8 m/s².

Operate and store the GOT in environments without direct sunlight, high temperature, dust, humidity, and vibrations.

For the status of conforming to various standards and laws (CE, UKCA, ATEX, UL/cUL, Class I Division 2, KC, KCs, and maritime certifications [ABS/BV/DNV/LR/NK/RINA]), please contact your local sales office.

Performance specifications

Item	Specifications						
	GT25 wide model						
	GT2512-WXTBD	GT2512-WXTSD	GT2510-WXTBD	GT2510-WXTSD	GT2507-WTBD	GT2507-WTSD	
Display section *1 *2	Display device	TFT color LCD					
	Screen size	12.1" widescreen			10.1" widescreen		
	Resolution	WXGA: 1280 × 800 dots			WVGA: 800 × 480 dots		
	Display size	261.12(10.28) (W) × 163.2(6.43) (H) mm(inch)		216.96(8.54) (W) × 135.6(5.34) (H) mm(inch)		152.40(6.00) (W) × 91.44(3.60) (H) mm (inch)	
	Number of displayed characters	16-dot standard font: 80 characters × 50 lines (two-byte characters) 12-dot standard font: 106 characters × 66 lines (two-byte characters)			16-dot standard font: 50 characters × 30 lines (two-byte characters) 12-dot standard font: 66 characters × 40 lines (two-byte characters)		
	Display color	65536 colors					
	Brightness adjustment	32 levels					
	Backlight	LED (not replaceable)					
Backlight life *4	Approx. 50000 h (operating ambient temperature: 25°C, display intensity: 50%)						
Touch panel *3 *11	Type	Analog resistive film					
	Key size	Minimum 2 × 2 dots *8 (per key)					
	Simultaneous press	Not available *5 (Only 1 point can be touched.)					
	Life	1 million touches or more (operating force: 0.98 N or less)					
Panel color	Black	Silver *10	Black	Silver *10	Black	Silver *10	
User memory	User memory capacity	Memory for storage (ROM) *12: 32 MB Memory for operation (RAM): 128 MB					
	Life (number of write times)	100000 times					
Built-in clock precision	±90 seconds/month (ambient temperature: 25 °C)						
Battery		GT11-50BAT lithium battery					
	Data to be backed up	SRAM data, clock data, system status log data					
Life	Approx. 5 years (ambient temperature: 25 °C)						
Built-in interface	RS-232	1 channel Transmission speed: 115200, 57600, 38400, 19200, 9600, 4800 bps Connector shape: D-sub 9-pin (male)					
	RS-422/485	1 channel Transmission speed: 115200, 57600, 38400, 19200, 9600, 4800 bps Connector shape: D-sub 9-pin (female)					
	Ethernet	2 channel Data transfer method: 100BASE-TX, 10BASE-T Connector shape: RJ45 (modular jack) AUTO MDI/MDI-X					
	USB (host)	1 channel (rear face) USB version: USB 2.0 (High-Speed 480 Mbps), Connector shape: USB-A					
	USB (device)	1 channel (front face) USB version: USB 2.0 (High-Speed 480 Mbps), Connector shape: USB Mini-B					
	SD memory card *12	1 channel, SDHC compliant (maximum 32 GB)					
	Wireless LAN communication unit interface	For installing a wireless LAN communication unit					
	Sound output interface	1 channel, WAV format (16 bits, 8.000 kHz/16.000 kHz, monoral) applicable plug: Φ3.5 stereo mini-plug (3-prong)					
	Buzzer output	Single tone (tone and tone length adjustable)					
POWER LED	2 colors (blue and orange)						
Protective structure *6	Front: IP67F *7 *9 Inside control panel: IP2X						
Safety standards, radio laws (as of June 2023)	CE, UKCA, UL, cUL, KC						
External dimensions	299(11.77) (W) × 219(8.62) (H) × 48(1.89) (D) mm(inch)		252(9.92) (W) × 194(7.64) (H) × 48(1.89) (D) mm(inch)		189(7.44) (W) × 142(5.59) (H) × 48(1.89) (D) mm(inch)		
Panel cut dimensions	290.5(11.44) (W) × 210.5(8.29) (H) mm(inch)		243.5(9.59) (W) × 185.5(7.30) (H) mm(inch)		180.5(7.11) (W) × 133.5(5.26) (H) mm(inch)		
Weight (excluding a fitting)	1.7(3.7) kg(lb)		1.2(2.6) kg(lb)		0.75(1.7) kg(lb)		
Compatible software package	GT Works3 Version 1.270G or later						

- *1 As a characteristic of liquid crystal display panels, bright dots (always lit) and dark dots (never lit) may appear on the panel. Since liquid crystal display panels comprise a great number of display elements, the appearance of bright and dark dots cannot be reduced to zero. Individual differences in liquid crystal display panels may cause differences in color, uneven brightness and flickering. Note that these phenomena are characteristics of liquid crystal display panels and it does not mean the products are defective or damaged.
- *2 Flickering may occur due to vibration, shock, or the display colors.
- *3 When a stylus is used, the touch panel has a life of 100 thousand touches. The stylus must satisfy the following specifications.
 - Material: polyacetal resin
 - Tip radius: 0.8 mm or more
- *4 To prevent the display section from burning in and lengthen the backlight life, enable the screen save function and turn off the backlight.
- *5 If you touch two points or more simultaneously on the touch panel, a switch in an unintended location may operate. Do not touch two points or more simultaneously on the touch panel.
- *6 Note that the structure does not guarantee protection in all users' environments. The GOT may not be used in certain environments where it is subjected to splashing oil or chemicals for a long period of time or soaked in oil mist.
- *7 To conform to IP67F, close the USB environmental protection cover by pushing the USB mark firmly. (The GOT conforms to IP2X when the USB environmental protection cover is open.)
- *8 The minimum size of a key that can be arranged. To ensure safe use of the product, the following settings are recommended.
 - Key size: 16 × 16 dots or larger
 - Distance between keys: 16 dots or more
- *9 The suffix "F" of IP67F or IP65F is a symbol that indicates protection rate against oil. It is described in the Appendix of Japanese Industrial Standard JIS C 0920.

Power supply specifications

Item	Specifications				
	GT25 wide model			GT25 handy GOT	
	GT2512-WXTBD GT2512-WXTSD	GT2510-WXTBD GT2510-WXTSD	GT2507-WTBD GT2507-WTSD	GT2506HS-VTBD	GT2505HS-VTBD
Power supply voltage	24 V DC (+25%, -20%)			24 V DC (+10%, -15%)	
Power consumption	Under the maximum load	20 W or less	16 W or less	11.6 W or less	8.4 W or less
	Main unit	14 W	9 W		
	Main unit (backlight OFF)	8 W	5 W	8.2 W	7.0 W
Inrush current	59 A or less (2 ms, ambient temperature: 25 °C, under the maximum load)			30 A or less (2 ms, ambient temperature: 25 °C, under the maximum load)	
Permissible instantaneous power failure time	5 ms or less				
Noise immunity	Noise voltage: 500 Vp-p, noise width: 1 μs, measured by a noise simulator with noise frequency ranging from 25 Hz to 60 Hz			Noise voltage: 1000 Vp-p, noise width: 1 μs, measured by a noise simulator with noise frequency ranging from 30 Hz to 100 Hz	
Withstand voltage	350 V AC for 1 minute across power terminals and earth			500 V DC for 1 minute across power terminals and earth	
Insulation resistance	500 V DC across power terminals and earth, 10 MΩ or more by an insulation resistance tester				

Item	Specifications		
	GT25 handy GOT		
	GT2506HS-VTBD	GT2505HS-VTBD	
Display section *1 *2	Display device	TFT color LCD	
	Screen size	6.5"	
	Resolution	VGA: 640 x 480 dots	
	Display size	132.5(5.22) (W) x 99.4(3.91) (H) mm(inch)	
	Number of displayed characters	16-dot standard font: 40 characters x 30 lines (two-byte characters) 12-dot standard font: 53 characters x 40 lines (two-byte characters)	
	Display color	65536 colors	
	Brightness adjustment	32 levels	
	Backlight	LED (not replaceable)	
Backlight life *4	Approx. 40000 h (operating ambient temperature: 25 °C, display intensity: 25 °C, display intensity: 50%)	Approx. 60000 h (operating ambient temperature: 25 °C, display intensity: 50%)	
Touch panel *3 *11	Type	Analog resistive film	
	Key size	Minimum 2 x 2 dots *8 (per key)	
	Simultaneous press	Not available *5 (Only 1 point can be touched.)	
	Life	1 million touches or more (operating force: 0.98 N or less)	
Panel color	Black		
Switch	Operation switch	6 switches (6 contacts/common), N/O contact, Maximum rating 10 mA/24 V DC, Life: 1000000 times, 6 green LEDs (lighting control from display section)	6 switches (6 contacts/common), N/O contact, Maximum rating 10 mA/24 V DC, Life: 1000000 times
	Grip switch	1 switch (single wiring) (IEDEC HE3B-M2PB), Enable switch (deadman switch) 3-position system of OFF ↔ ON ↔ OFF, 2 N/O contacts, Maximum rating 1 A/24 V DC (resistance load), Maximum rating 0.3 A/24 V DC (induction load), Life: 100000 times, 1 green LED (lighting control from display section)	
	Emergency stop switch	1 switch (single wiring) (IEDEC XA1E-BV303P), 3 N/C contacts, Maximum rating 1 A/24 V DC (resistance load), Maximum rating 0.3 A/24 V DC (induction load), Life: 100000 times	
	Key/lock switch (2-position switch)	1 switch (single wiring) (IEDEC AS6M-2KT1PB), 2-notch type (Manual stop at each position/A key can be inserted and removed on only the left side./ On the right side, a key cannot be removed./Two keys are provided.), 2-position, Maximum rating 1 A/24 V DC (resistance load), Maximum rating 0.3 A/24 V DC (induction load), Life: 100000 times	
	User memory	User memory capacity	Memory for storage (ROM) *12: 32 MB Memory for operation (RAM): 80 MB
	Life (number of write times)	100000 times	
Built-in clock precision	±90 seconds/month (ambient temperature: 25 °C)		
Battery	GT15-BAT lithium battery	GT11-50BAT lithium battery	
	Data to be backed up	SPRAM data, clock data, system status log data	
	Life	Approx. 5 years (ambient temperature: 25 °C)	
Built-in interface	RS-232	RS-232 or RS-422/485, 1 channel (Select one channel. RS-422/485 is set as the factory default.) Transmission speed: 115200, 57600, 38400, 19200, 9600, 4800 bps Connector shape: Square 42 pins (male)	RS-232 or RS-422, 1 channel (Select one channel from RS-232, RS-422, or Ethernet. Ethernet is set as the factory default.) Transmission speed: 115200, 57600, 38400, 19200, 9600, 4800 bps Connector shape: Round 32 pins (male)
	RS-422/485 *14		
	Ethernet	1 channel Data transfer method: 100BASE-TX, 10BASE-T Connector shape: Square 42 pins (male)	1 channel (Select one channel from RS-232, RS-422, or Ethernet. Ethernet is set as the factory default.) Data transfer method: 100BASE-TX, 10BASE-T Connector shape: Round 32 pins (male)
	USB (host)	1 channel (top face) USB version: USB 2.0 (High-Speed 480 Mbps), Connector shape: USB-A	
	USB (device)	1 channel (top face) USB version: USB 2.0 (High-Speed 480 Mbps), Connector shape: USB Mini-B	
	SD memory card *12	1 channel, SDHC compliant (maximum 32 GB)	
Buzzer output	Single tone (tone and tone length adjustable)		
POWER LED	2 colors (blue and orange)		
Protective structure *6	IP65F *9*13 (When an external cable is connected. The rating is not applied to the relay connector side of the external cable.)		
Safety standards, radio laws (as of June 2023)	CE, UKCA, UL, cUL, KC		
External dimensions	201(7.91) (W) x 230(9.06) (H) x 97(3.82) (D) mm(inch) (excluding projections such as the emergency stop switch)	145(5.71) (W) x 185(7.28) (H) x 79.3(3.12) (D) mm(inch) (excluding projections such as the emergency stop switch)	
Weight	1.2(2.6) kg(lb) (GOT main unit only)	0.79(1.7) kg(lb) (GOT main unit only)	
Compatible software package	GT Works3 Version 1.270G or later		

*10 The lower part of the panel including the USB environmental protection cover is black.

*11 Repeatedly touching the outer edge of the actual display area may cause the product to fail.

*12 While writing data to the memory for storage (ROM) or an SD memory card, if GOT is powered off, the data may be corrupted which may cause the GOT to stop operating.

*13 The rating is not applied when the interface environment protection cover or the environmental protection back cover is removed.

*14 GT2505HS-VTBD supports RS-422 only.

Specifications

GT25 rugged model

General specifications

Item	Specifications *5					
Operating ambient temperature *1	-20 °C to 65 °C					
Storage ambient temperature	-30 °C to 75 °C					
Operating ambient humidity	10% RH to 90% RH, non-condensing					
Storage ambient humidity	10% RH to 90% RH, non-condensing					
Vibration resistance	Compliant with IEC 60068-2-6	Under intermittent vibration	Frequency	Acceleration	Half amplitude	Sweep count
			5 to 8.4 Hz	—	7.0 mm	
		Under continuous vibration	8.4 to 150 Hz	19.6 m/s ²	—	10 times in each X, Y, or Z direction
			5 to 8.4 Hz	—	7.0 mm	
		8.4 to 150 Hz	19.6 m/s ²	—	—	
Shock resistance	IEC 60068-2-27 (392 m/s ² (40G), 3 times in each X, Y, or Z direction)					
Operating atmosphere	No greasy fumes, corrosive gas, flammable gas, excessive conductive dust, and direct sunlight (as well as at storage)					
Operating altitude *2	2000 m or less					
Installation location	Inside control panel					
Overvoltage category *3	II or less					
Pollution degree *4	2 or less					
Cooling method	Self-cooling					
Grounding	Grounding with a ground resistance of 100 Ω or less by using a ground cable that has a cross-sectional area of 2 mm ² or more. If impossible, connect the ground cable to the control panel.					

- *1 Includes the temperature inside the enclosure of the control panel to which the GOT is installed.
- *2 Do not use or store the GOT under a pressure higher than the atmospheric pressure at altitude 0 m. Doing so may cause a malfunction. Air purging by applying pressure to the control panel may create clearance between the surface sheet and the touch panel. This may cause the touch panel to be not sensitive enough or the sheet to come off.
- *3 This indicates the section of the power supply to which the equipment is assumed to be connected between the public electrical power distribution network and the machinery within the premises. Category II applies to equipment that is supplied with power from fixed facilities. The withstand surge voltage for the equipment with the rated voltage up to 300 V is 2500 V.
- *4 This indicates the occurrence rate of conductive material in an environment where a device is used. Pollution degree 2 indicates an environment where only non-conductive pollution occurs normally and a temporary conductivity caused by condensation shall be expected depending on the conditions.
- *5 Communication units and options usable with the rugged model can be used in the environment described in the general specifications of the rugged model. However, when a protective cover for oil is mounted on the GOT, the operating ambient temperature must be -20°C to 50°C. For using peripheral devices to be connected to the GOT, please refer to the relevant product manual.

Although GT2507T-W is ruggedized for environments such as UV rays, temperatures and vibrations, its operation is not guaranteed in all conditions and environments. Make sure to use or store the GOT in an appropriate environment.

For the status of conforming to various standards and laws (CE, UKCA, ATEX, UL/cUL, Class I Division 2, KC, KCs, and maritime certifications [ABS/BV/DNV/LR/NK/RINA]), please contact your local sales office.

Performance specifications

Item		Specifications
		GT2507T-WTSD
Display section *1 *2	Display device	TFT color LCD
	Screen size	7" widescreen
	Resolution	WVGA: 800 × 480 dots
	Display size	152.40(6.00) (W) × 91.44(3.60) (H) mm (inch)
	Number of displayed characters	16-dot standard font: 50 characters × 30 lines (two-byte characters) 12-dot standard font: 66 characters × 40 lines (two-byte characters)
	Display color	65536 colors
	Brightness adjustment	32 levels
	Backlight	LED (not replaceable)
Backlight life *4	Approx. 50000 h (operating ambient temperature: 25°C, display intensity: 50%)	
Touch panel *3 *9	Type	Analog resistive film
	Key size	Minimum 2 × 2 dots *7 (per key)
	Simultaneous press	Not available *5 (Only 1 point can be touched.)
	Life	1 million touches or more (operating force: 0.98 N or less)
Panel color	Silver	
User memory	User memory capacity	Memory for storage (ROM) *10: 32 MB Memory for operation (RAM): 128 MB
	Life (number of write times)	100000 times
Built-in clock precision	±90 seconds/month (ambient temperature: 25 °C)	
Battery		GT11-50BAT lithium battery
	Data to be backed up	SRAM data, clock data, system status log data
	Life	Approx. 5 years (ambient temperature: 25 °C)
Built-in interface	RS-232	1 channel Transmission speed: 115200, 57600, 38400, 19200, 9600, 4800 bps Connector shape: D-sub 9-pin (male)
	RS-422/485	1 channel Transmission speed: 115200, 57600, 38400, 19200, 9600, 4800 bps Connector shape: D-sub 9-pin (female)
	Ethernet	2 channels Data transfer method: 100BASE-TX, 10BASE-T Connector shape: RJ45 (modular jack) AUTO MDI/MDI-X
	USB (host)	1 channel (rear face) USB version: USB 2.0 (High-Speed 480 Mbps), Connector shape: USB-A
	USB (device)	1 channel (rear face) USB version: USB 2.0 (High-Speed 480 Mbps), Connector shape: USB Mini-B
	SD memory card *10	1 channel, SDHC compliant (maximum 32 GB)
	Wireless LAN communication unit interface	For installing a wireless LAN communication unit
	Sound output interface	1 channel, WAV format (16 bits, 8.000 kHz/16.000 kHz, monoral) applicable plug: Φ3.5 stereo mini-plug (3-prong) Single tone (tone and tone length adjustable)
Buzzer output	2 colors (blue and orange)	
POWER LED	Front: Approximately 95% (370 nm)	
UV cutoff	Front: IP66F *8, IP67F *8 Inside control panel: IP2X	
Protective structure *6	CE, UKCA, UL, cUL, KC	
Safety standards, radio laws (as of June 2023)	214(8.43) (W) × 158(6.22) (H) × 55(2.17) (D) mm(inch)	
External dimensions	197(7.76) (W) × 141(5.55) (H) mm(inch)	
Panel cut dimensions	1.2(2.6) kg(lb)	
Weight (excluding a fitting)	GT Works3 Version 1.270G or later	
Compatible software package		

*1 As a characteristic of liquid crystal display panels, bright dots (always lit) and dark dots (never lit) may appear on the panel. Since liquid crystal display panels comprise a great number of display elements, the appearance of bright and dark dots cannot be reduced to zero. Individual differences in liquid crystal display panels may cause differences in color, uneven brightness and flickering. Note that these phenomena are characteristics of liquid crystal display panels and it does not mean the products are defective or damaged.

*2 Flickering may occur due to vibration, shock, or the display colors.

*3 When a stylus is used, the touch panel has a life of 100 thousand touches. The stylus must satisfy the following specifications.
• Material: polyacetal resin • Tip radius: 0.8 mm or more

*4 To prevent the display section from burning in and lengthen the backlight life, enable the screen save function and turn off the backlight.

*5 If you touch two points or more simultaneously on the touch panel, a switch in an unintended location may operate. Do not touch two points or more simultaneously on the touch panel.

*6 Note that the structure does not guarantee protection in all users' environments. The GOT may not be used in certain environments where it is subjected to splashing oil or chemicals for a long period of time or soaked in oil mist.

*7 The minimum size of a key that can be arranged. To ensure safe use of the product, the following settings are recommended.
• Key size: 16 × 16 dots or larger • Distance between keys: 16 dots or more

*8 The suffix "F" of IP66F and IP67F is a symbol that indicates protection rate against oil. It is described in the Appendix of Japanese Industrial Standard JIS C 0920.

*9 Repeatedly touching the outer edge of the actual display area may cause the product to fail.

*10 While writing data to the memory for storage (ROM) or an SD memory card, if GOT is powered off, the data may be corrupted which may cause the GOT to stop operating.

Power supply specifications

Item		Specifications
		GT2507T-WTSD
Power supply voltage		24 V DC (+25%, -20%)
Power consumption	Under the maximum load	17 W or less
	Main unit	11 W
	Main unit (backlight OFF)	7 W
Inrush current		59 A or less (2 ms, ambient temperature: 25 °C, under the maximum load)
Permissible instantaneous power failure time		5 ms or less
Noise immunity		Noise voltage: 500 Vp-p, noise width: 1 μs, measured by a noise simulator with noise frequency ranging from 25 Hz to 60 Hz
Withstand voltage		350 V AC for 1 minute across power terminals and earth
Insulation resistance		500 V DC across power terminals and earth, 10 MΩ or more by an insulation resistance tester

Specifications

GT23 model

General specifications

Item	Specifications					
Operating ambient temperature *1	0 °C to 55 °C *6					
Storage ambient temperature	-20 °C to 60 °C					
Operating ambient humidity	10% RH to 90% RH, non-condensing *2					
Storage ambient humidity	10% RH to 90% RH, non-condensing *2					
Vibration resistance	Compliant with JIS B 3502 and IEC 61131-2 *7	Under intermittent vibration	Frequency	Acceleration	Half amplitude	Sweep count
			5 to 8.4 Hz	—	3.5 mm	
		Under continuous vibration	8.4 to 150 Hz	9.8 m/s ²	—	10 times in each X, Y, or Z direction
			5 to 8.4 Hz	—	1.75 mm	—
8.4 to 150 Hz	4.9 m/s ²	—	—	—		
Shock resistance	Compliant with JIS B 3502 and IEC 61131-2 (147 m/s ² (15G), 3 times in each X, Y, or Z direction)					
Operating atmosphere	No greasy fumes, corrosive gas, flammable gas, excessive conductive dust, and direct sunlight (as well as at storage)					
Operating altitude *3	2000 m or less					
Installation location	Inside control panel					
Overvoltage category *4	II or less					
Pollution degree *5	2 or less					
Cooling method	Self-cooling					
Grounding	Grounding with a ground resistance of 100 Ω or less by using a ground cable that has a cross-sectional area of 2 mm ² or more. If impossible, connect the ground cable to the control panel.					
Operate and store the GOT in environments without direct sunlight, high temperature, dust, humidity, and vibrations.						
For the status of conforming to various standards and laws (CE, UKCA, ATEX, UL/cUL, Class I Division 2, KC, KCs, and maritime certifications [ABS/BV/DNV/LR/NK/RINA]), please contact your local sales office.						

- *1 Includes the temperature inside the enclosure of the control panel to which the GOT is installed.
- *2 If the ambient temperature exceeds 40 °C, the absolute humidity must not exceed 90% RH at 40 °C.
- *3 Do not use or store the GOT under a pressure higher than the atmospheric pressure at altitude 0 m. Doing so may cause a malfunction. Air purging by applying pressure to the control panel may create clearance between the surface sheet and the touch panel. This may cause the touch panel to be not sensitive enough or the sheet to come off.
- *4 This indicates the section of the power supply to which the equipment is assumed to be connected between the public electrical power distribution network and the machinery within the premises. Category II applies to equipment that is supplied with power from fixed facilities. The withstand surge voltage for the equipment with the rated voltage up to 300 V is 2500 V.
- *5 This indicates the occurrence rate of conductive material in an environment where a device is used. Pollution degree 2 indicates an environment where only non-conductive pollution occurs normally and a temporary conductivity caused by condensation shall be expected depending on the conditions.
- *6 When a protective cover for oil is mounted on the GOT, the maximum operating ambient temperature must be 5°C lower than the one described in the general specifications.
- *7 The definition of 1 G has been changed from 9.8 m/s² to 10 m/s² in JIS B 3502:2021 and IEC 61131-2 ED.3. The product was tested by using the former definition, 1 G = 9.8 m/s².

Performance specifications

Item	Specifications		
	GT2310-VTBA GT2310-VTBD	GT2308-VTBA GT2308-VTBD	
Display section *1 *2	Display device	TFT color LCD	
	Screen size	10.4"	
	Resolution	VGA: 640 x 480 dots	
	Display size	211.2(8.31) (W) x 158.4(6.24) (H) mm(inch)	
	Number of displayed characters	16-dot standard font: 40 characters x 30 lines (two-byte characters) 12-dot standard font: 53 characters x 40 lines (two-byte characters)	
	Display color	65536 colors	
	Brightness adjustment	16 levels	
	Backlight	LED (not replaceable)	
	Backlight life *4	Approx. 50000 h (operating ambient temperature: 25 °C, display intensity: 50%)	
	Touch panel *3 *9	Type	Analog resistive film
Key size		Minimum 2 x 2 dots *7 (per key)	
Simultaneous press		Not available *5 (Only 1 point can be touched.)	
Life		1 million touches or more (operating force: 0.98 N or less)	
Panel color	Black		
User memory	User memory capacity	Memory for storage (ROM) *10: 9 MB Memory for operation (RAM): 9 MB	
	Life (number of write times)	100000 times	
Built-in clock precision	±90 seconds/month (ambient temperature: 25 °C)		
Battery	GT11-50BAT lithium battery (option)		
	Data to be backed up	SRAM data, clock data, system status log data	
Built-in interface	Life	Approx. 5 years (ambient temperature: 25 °C)	
	RS-232	1 channel Transmission speed: 115200, 57600, 38400, 19200, 9600, 4800 bps Connector shape: D-sub 9-pin (male)	
	RS-422/485	1 channel Transmission speed: 115200, 57600, 38400, 19200, 9600, 4800 bps Connector shape: D-sub 9-pin (female)	
	Ethernet	1 channel Data transfer method: 100BASE-TX, 10BASE-T Connector shape: RJ45 (modular jack) AUTO MDI/MDI-X	
	USB (host)	1 channel (rear face) USB version: USB 1.1 (Full-Speed 12 Mbps), Connector shape: USB-A	
	USB (device)	1 channel (rear face) USB version: USB 1.1 (Full-Speed 12 Mbps), Connector shape: USB Mini-B	
	SD memory card *10	1 channel, SDHC compliant (maximum 32 GB)	
Buzzer output	Single tone (tone length adjustable)		
POWER LED	2 colors (blue and orange)		
Protective structure *6	Front: IP67F *8 Inside control panel: IP2X		
Safety standards, radio laws (as of June 2023)	CE, UKCA, UL, cUL, KC		
External dimensions	303(11.93) (W) x 218(8.58) (H) x 56(2.20) (D) mm(inch)	241(9.49) (W) x 194(7.64) (H) x 56(2.20) (D) mm(inch)	
Panel cut dimensions	289(11.38) (W) x 200(7.87) (H) mm(inch)	227(8.94) (W) x 176(6.93) (H) mm(inch)	
Weight (excluding a fitting)	1.9(4.2) kg(lb)	1.5(3.3) kg(lb)	
Compatible software package	GT Works3 Version 1.270G or later		

- *1 As a characteristic of liquid crystal display panels, bright dots (always lit) and dark dots (never lit) may appear on the panel. Since liquid crystal display panels comprise a great number of display elements, the appearance of bright and dark dots cannot be reduced to zero. Individual differences in liquid crystal display panels may cause differences in color, uneven brightness and flickering. Note that these phenomena are characteristics of liquid crystal display panels and it does not mean the products are defective or damaged.
- *2 Flickering may occur due to vibration, shock, or the display colors.
- *3 When a stylus is used, the touch panel has a life of 100 thousand touches. The stylus must satisfy the following specifications.
 - Material: polyacetal resin
 - Tip radius: 0.8 mm or more
- *4 To prevent the display section from burning in and lengthen the backlight life, enable the screen save function and turn off the backlight.
- *5 If you touch two points or more simultaneously on the touch panel, a switch in an unintended location may operate. Do not touch two points or more simultaneously on the touch panel.
- *6 Note that the structure does not guarantee protection in all users' environments. The GOT may not be used in certain environments where it is subjected to splashing oil or chemicals for a long period of time or soaked in oil mist.
- *7 The minimum size of a key that can be arranged. To ensure safe use of the product, the following settings are recommended.
 - Key size: 16 x 16 dots or larger
 - Distance between keys: 16 dots or more
- *8 The suffix "F" of IP67F is a symbol that indicates protection rate against oil. It is described in the Appendix of Japanese Industrial Standard JIS C 0920.
- *9 Repeatedly touching the outer edge of the actual display area may cause the product to fail.
- *10 While writing data to the memory for storage (ROM) or an SD memory card, if GOT is powered off, the data may be corrupted which may cause the GOT to stop operating.

Power supply specifications

Item	Specifications			
	GT2310-VTBA	GT2308-VTBA	GT2310-VTBD	GT2308-VTBD
Power supply voltage	100 V AC to 240 V AC (+10%, -15%)		24 V DC (+25%, -20%)	
Power supply frequency	50 Hz/60 Hz (±5%)			
Power consumption	Under the maximum load	18 W or less	11 W or less	11 W or less
	Main unit	15 W	9 W	8 W
	Main unit (backlight OFF)	8 W	6 W	6 W
Inrush current	40 A or less (4 ms, ambient temperature: 25 °C, under the maximum load)		40 A or less (2 ms, ambient temperature: 25 °C, under the maximum load)	
Permissible instantaneous power failure time	20 ms or less (100 V AC or more)		10 ms or less	
Noise immunity	Noise voltage: 1500 Vp-p, noise width: 1 μs, measured by a noise simulator with noise frequency ranging from 25 Hz to 60 Hz		Noise voltage: 500 Vp-p, noise width: 1 μs, measured by a noise simulator with noise frequency ranging from 25 Hz to 60 Hz	
Withstand voltage	1500 V AC for 1 minute across power terminals and earth		350 V AC for 1 minute across power terminals and earth	
Insulation resistance	500 V DC across power terminals and earth, 10 MΩ or more by an insulation resistance tester			



Specifications

GT21 wide model/GT21 model

General specifications

Item	Specifications	
Operating ambient temperature *1	0 °C to 55 °C *7 (horizontal installation), 0 °C to 50 °C (vertical installation)	
Storage ambient temperature	-20 °C to 60 °C	
Operating ambient humidity	10% RH to 90% RH, non-condensing *2	
Storage ambient humidity	10% RH to 90% RH, non-condensing *2	
Vibration resistance	Compliant with JIS B 3502 and IEC 61131-2 *8	
	Under intermittent vibration	Frequency: 5 to 8.4 Hz, 8.4 to 150 Hz; Acceleration: —, 9.8 m/s ² ; Half amplitude: 3.5 mm; Sweep count: 10 times in each X, Y, or Z direction
	Under continuous vibration	5 to 8.4 Hz: —, 1.75 mm
		8.4 to 150 Hz: 4.9 m/s ² , —
Shock resistance	Compliant with JIS B 3502 and IEC 61131-2 (147 m/s ² (15G), 3 times in each X, Y, or Z direction)	
Operating atmosphere	No greasy fumes, corrosive gas, flammable gas, excessive conductive dust, and direct sunlight (as well as at storage)	
Operating altitude *3	2000 m or less	
Installation location	Inside control panel	
Overvoltage category *4	II or less	
Pollution degree *5	2 or less	
Cooling method	Self-cooling	
Grounding	GT2107-W: Grounding with a ground resistance of 100 Ω or less by using a ground cable that has a cross-sectional area of 2 mm ² or more. If impossible, connect the ground cable to the control panel. GT2104, GT2103: Grounding with a ground resistance of 100 Ω or less by using a ground cable that has a cross-sectional area of 0.14 to 1.5 mm ² (single wire), 0.14 to 1.0 mm ² (stranded wire), or 0.25 to 0.5 mm ² (rod terminal with an insulation sleeve). If impossible, connect the ground cable to the control panel.*6	

- *1 Includes the temperature inside the enclosure of the control panel to which the GOT is installed.
- *2 If the ambient temperature exceeds 40 °C, the absolute humidity must not exceed 90% RH at 40 °C.
- *3 Do not use or store the GOT under a pressure higher than the atmospheric pressure at altitude 0 m. Doing so may cause a malfunction. Air purging by applying pressure to the control panel may create clearance between the surface sheet and the touch panel. This may cause the touch panel to be not sensitive enough or the sheet to come off.
- *4 This indicates the section of the power supply to which the equipment is assumed to be connected between the public electrical power distribution network and the machinery within the premises. Category II applies to equipment that is supplied with power from fixed facilities. The withstand surge voltage for the equipment with the rated voltage up to 300 V is 2500 V.
- *5 This indicates the occurrence rate of conductive material in an environment where a device is used. Pollution degree 2 indicates an environment where only non-conductive pollution occurs normally and a temporary conductivity caused by condensation shall be expected depending on the conditions.
- *6 5 V DC type does not require grounding.
- *7 When a protective cover for oil is mounted on the GOT, the maximum operating ambient temperature must be 5°C lower than the one described in the general specifications.
- *8 The definition of 1 G has been changed from 9.8 m/s² to 10 m/s² in JIS B 3502:2021 and IEC 61131-2 ED.3. The product was tested by using the former definition, 1 G = 9.8 m/s².

Operate and store the GOT in environments without direct sunlight, high temperature, dust, humidity, and vibrations.

For the status of conforming to various standards and laws (CE, UKCA, ATEX, UL/cUL, Class I Division 2, KC, KCs, and maritime certifications [ABS/DNV/LR/NK/PINA]), please contact your local sales office.

Performance specifications

Item	Specifications	
	GT21 wide model	
	GT2107-WTBD	GT2107-WTSD
Display section *1 *2	Display device	TFT color LCD
	Screen size	7" widescreen
	Resolution	WVGA: 800 × 480 dots
	Display size	152.40(6.00) (W) × 91.44(3.60) (H) mm (inch)
	Number of displayed characters	16-dot standard font: 50 characters × 30 lines (two-byte characters) 12-dot standard font: 66 characters × 40 lines (two-byte characters)
	Display color	65536 colors
	Brightness adjustment	32 levels
	Backlight	LED (not replaceable)
Backlight life *4	Approx. 50000 h (operating ambient temperature: 25 °C, display intensity: 50%)	
Touch panel *3 *11	Type	Analog resistive film
	Key size	Minimum 2 × 2 dots *9 (per key)
	Simultaneous press	Not available *5 (Only 1 point can be touched.)
	Life	1 million touches or more (operating force: 0.98 N or less)
Panel color	Black	Silver *15
User memory	User memory capacity	Memory for storage (ROM) *12: 15 MB
	Life (number of write times)	100000 times
Built-in clock precision	±45 seconds/month (ambient temperature: 25 °C)	
Battery	GT11-50BAT lithium battery	
	SPRAM data, clock data	
	Life: Approx. 5 years (ambient temperature: 25 °C)	
Built-in interface	RS-232	1 channel Transmission speed: 115200, 57600, 38400, 19200, 9600, 4800 bps Connector shape: D-sub 9-pin (male)
	RS-422/485	1 channel Transmission speed: 115200, 57600, 38400, 19200, 9600, 4800 bps Connector shape: D-sub 9-pin (female)
	RS-422	—
	Ethernet	1 channel Data transfer method: 100BASE-TX, 10BASE-T Connector shape: RJ45 (modular jack) AUTO MDI/MDI-X
	USB (host)	1 channel (rear face) USB version: USB 1.1 (Full-Speed 12 Mbps), Connector shape: USB-A
	USB (device)	1 channel (front face) USB version: USB 1.1 (Full-Speed 12 Mbps), Connector shape: USB Mini-B
	SD memory card *12	1 channel, SDHC compliant (maximum 32 GB)
Buzzer output	Single tone (tone length adjustable)	
Protective structure *7	Front: IP67F *10 *14 Inside control panel: IP2X	
Safety standards, radio laws (as of June 2023)	CE, UKCA, UL, cUL, KC	
External dimensions	189(7.44) (W) × 142(5.59) (H) × 48(1.89) (D) mm(inch)	
Panel cut dimensions	180.5(7.11) (W) × 133.5(5.26) (H) mm(inch)	
Weight (excluding a fitting)	0.7(1.54) kg(lb)	
Compatible software package	GT Works3 Version 1.270G or later	

- *1 As a characteristic of liquid crystal display panels, bright dots (always lit) and dark dots (never lit) may appear on the panel. Since liquid crystal display panels comprise a great number of display elements, the appearance of bright and dark dots cannot be reduced to zero. Individual differences in liquid crystal display panels may cause differences in color, uneven brightness and flickering. Note that these phenomena are characteristics of liquid crystal display panels and it does not mean the products are defective or damaged.
- *2 Flickering may occur due to vibration, shock, or the display colors.
- *3 When a stylus is used, the touch panel has a life of 100 thousand touches. The stylus must satisfy the following specifications.
 - Material: polyacetal resin
 - Tip radius: 0.8 mm or more
- *4 To prevent the display section from burning in and lengthen the backlight life, enable the screen save function and turn off the backlight.
- *5 If you touch two points or more simultaneously on the touch panel, a switch in an unintended location may operate. Do not touch two points or more simultaneously on the touch panel.
- *6 The SD memory card unit (GT21-03SDCD), sold separately, needs to be mounted.
- *7 Note that the structure does not guarantee protection in all users' environments. The GOT may not be used in certain environments where it is subjected to splashing oil or chemicals for a long period of time or soaked in oil mist.
- *8 The dimension when the SD memory card unit (GT21-03SDCD) is mounted is 113(4.45) (W) × 74(2.91) (H) × 32(1.26) (D) mm(inch).
- *9 The minimum size of a key that can be arranged. To ensure safe use of the product, the following settings are recommended.
 - Key size: 16 × 16 dots or larger
 - Distance between keys: 16 dots or more (GT2107-WTBD, GT2107-WTSD)
- *10 The suffix "F" of IP67F is a symbol that indicates protection rate against oil. It is described in the Appendix of Japanese Industrial Standard JIS C 0920.
- *11 Repeatedly touching the outer edge of the actual display area may cause the product to fail.

Power supply specifications

Item	Specifications						
	GT21 wide model	GT21 model					
	GT2107-WTBD GT2107-WTSD	GT2104-RTBD	GT2103-PMBD	GT2103-PMBDS	GT2103-PMBDS2	GT2103-PMBLS	
Power supply voltage	24 V DC (+10%, -15%)					5 V DC (+5%, -5%) Power from the PLC	
Power supply frequency	-						
Power consumption	Under the maximum load	11.3 W or less	4.4 W or less	2.6 W or less	1.9 W or less	2.2 W or less	1.1 W or less
	Main unit (backlight OFF)	7.0 W	2.9 W	2.0 W	1.3 W	1.6 W	0.7 W
Inrush current	35 A or less (3 ms, ambient temperature: 25 °C, under the maximum load)	18 A or less (2 ms, ambient temperature: 25 °C, under the maximum load)	30 A or less (1 ms, ambient temperature: 25 °C, under the maximum load)			-	
Permissible instantaneous power failure time	5 ms or less					-	
Noise immunity	Noise voltage: 1000 Vp-p, noise width: 1 μs, measured by a noise simulator with noise frequency ranging from 30 Hz to 100 Hz						
Withstand voltage	500 V AC for 1 minute across power terminals and earth					-	
Insulation resistance	500 V DC across power terminals and earth, 10 MΩ or more by an insulation resistance tester					-	

Item	Specifications					
	GT21 model					
	GT2104-RTBD	GT2103-PMBD	GT2103-PMBDS	GT2103-PMBDS2	GT2103-PMBLS	
Display section *1 *2	Display device	TFT color LCD				
	Screen size	4.3"				
	Resolution	480 × 272 dots				
	Display size	95.0(3.74) (W) × 53.8(2.12) (H) mm(inch)				
	Number of displayed characters	16-dot standard font: 30 characters × 17 lines (two-byte characters) 12-dot standard font: 40 characters × 22 lines (two-byte characters)		16-dot standard font: 20 characters × 8 lines (two-byte characters) 12-dot standard font: 26 characters × 10 lines (two-byte characters)		
	Display color	65536 colors				
	Brightness adjustment	32 levels				
	Backlight	LED (not replaceable)				
Touch panel *3 *11	Type	Analog resistive film				
	Key size	Minimum 2 × 2 dots *9 (per key)				
	Simultaneous press	Not available *5 (Only 1 point can be touched.)				
	Life	1 million touches or more (operating force: 0.98 N or less)				
	Panel color	Black				
User memory	User memory capacity	Memory for storage (ROM) *12: 9 MB		Memory for storage (ROM) *12: 3 MB		
	Life (number of write times)	100000 times				
Built-in clock precision	±45 seconds/month (ambient temperature: 25 °C)		-			
Battery	Data to be backed up	GT11-50BAT lithium battery		-		
	Life	SRAM data, clock data		-		
	Life (ambient temperature: 25 °C)	Approx. 5 years		-		
Built-in interface	RS-232	1 channel Transmission speed: 115200, 57600, 38400, 19200, 9600, 4800 bps Connector shape: 9-pin connector terminal block	-	1 channel Transmission speed: 115200, 57600, 38400, 19200, 9600, 4800 bps Connector shape: MINI-DIN 6-pin (female)	2 channels Transmission speed: 115200, 57600, 38400, 19200, 9600, 4800 bps Connector shape: 9-pin connector terminal block, MINI-DIN 6-pin (female)	-
	RS-422/485	1 channel Transmission speed: 115200, 57600, 38400, 19200, 9600, 4800 bps Connector shape: 9-pin connector terminal block	1 channel Transmission speed: 115200, 57600, 38400, 19200, 9600, 4800 bps Connector shape: 5-pin connector terminal block	1 channel Transmission speed: 115200, 57600, 38400, 19200, 9600, 4800 bps Connector shape: 9-pin connector terminal block	-	
	RS-422	-				1 channel Transmission speed: 115200, 57600, 38400, 19200, 9600, 4800 bps Connector shape: 9-pin connector terminal block *13
	Ethernet	1 channel Data transfer method: 100BASE-TX, 10BASE-T Connector shape: RJ45 (modular jack) AUTO MDI/MDI-X		-		
	USB (device)	1 channel (rear face) USB version: USB 1.1 (Full-Speed 12 Mbps), Connector shape: USB Mini-B				
	SD memory card *12	1 channel, SDHC compliant (maximum 32 GB)	1 channel, SDHC compliant (maximum 32 GB) *6			-
Buzzer output	Single tone (tone length adjustable)					
Protective structure *7	Front: IP67F *10 Inside control panel: IP2X					
Safety standards, radio laws (as of June 2023)	CE, UKCA, UL, cUL, KC					
External dimensions	128(5.04) (W) × 102(4.02) (H) × 40(1.57) (D) mm(inch)	113(4.45) (W) × 74(2.91) (H) × 32(1.26) (D) mm(inch)	113(4.45) (W) × 74(2.91) (H) × 27(1.06) (D) mm(inch) *8		113(4.45) (W) × 74(2.91) (H) × 27(1.06) (D) mm(inch)	
Panel cut dimensions	118(4.65) (W) × 92(3.62) (H) mm(inch)					105(4.13) (W) × 66(2.60) (H) mm(inch)
Weight (excluding a fitting)	0.4(0.88) kg(lb)		0.2(0.44) kg(lb)		0.18(0.40) kg(lb)	
Compatible software package	GT Works3 Version 1.270G or later					

*12 While writing data to the memory for storage (ROM) or an SD memory card, if GOT is powered off, the data may be corrupted which may cause the GOT to stop operating.

*13 Use a 3 m or shorter cable.

*14 To conform to IP67F, close the USB environmental protection cover by pushing the USB mark firmly. (The GOT conforms to IP2X when the USB environmental protection cover is open.)

*15 The lower part of the panel including the USB environmental protection cover is black.

Specifications

GS21 model

General specifications

Item	Specifications					
Operating ambient temperature *1	0 °C to 50 °C					
Storage ambient temperature	-20 °C to 60 °C					
Operating ambient humidity	10% RH to 90% RH, non-condensing *2					
Storage ambient humidity	10% RH to 90% RH, non-condensing *2					
Vibration resistance	Compliant with IEC 61131-2 *6	Under intermittent vibration	Frequency	Acceleration	Half amplitude	Sweep count
			5 to 8.4 Hz	—	3.5 mm	
		Under continuous vibration	8.4 to 150 Hz	9.8 m/s ²	—	10 times in each X, Y, or Z direction
			5 to 8.4 Hz	—	1.75 mm	
		8.4 to 150 Hz	4.9 m/s ²	—	—	
Shock resistance	Compliant with IEC 61131-2 (147 m/s ² (15G), 3 times in each X, Y, or Z direction)					
Operating atmosphere	No greasy fumes, corrosive gas, flammable gas, excessive conductive dust, and direct sunlight (as well as at storage)					
Operating altitude *3	2000 m or less					
Installation location	Inside control panel					
Overvoltage category *4	II or less					
Pollution degree *5	2 or less					
Cooling method	Self-cooling					
Grounding	Grounding with a ground resistance of 100 Ω or less by using a ground cable that has a cross-sectional area of 2 mm ² or more. If impossible, connect the ground cable to the control panel.					

- *1 Includes the temperature inside the enclosure of the control panel to which the GOT is installed.
- *2 If the ambient temperature exceeds 40 °C, the absolute humidity must not exceed 90% RH at 40 °C.
- *3 Do not use or store the GOT under a pressure higher than the atmospheric pressure at altitude 0 m. Doing so may cause a malfunction. Air purging by applying pressure to the control panel may create clearance between the surface sheet and the touch panel. This may cause the touch panel to be not sensitive enough or the sheet to come off.
- *4 This indicates the section of the power supply to which the equipment is to be connected between the public electrical power distribution network and the machinery within the premises. Category II applies to equipment that is supplied with power from fixed facilities. The withstand surge voltage for the equipment with the rated voltage up to 300 V is 2500 V.
- *5 This indicates the occurrence rate of conductive material in an environment where a device is used. Pollution degree 2 indicates an environment where only non-conductive pollution occurs normally and a temporary conductivity caused by condensation shall be expected depending on the conditions.
- *6 The definition of 1 G has been changed from 9.8 m/s² to 10 m/s² in IEC 61131-2 ED.3. The product was tested by using the former definition, 1 G = 9.8 m/s².

Operate and store the GOT in environments without direct sunlight, high temperature, dust, humidity, and vibrations.

For the status of conforming to various standards and laws (CE, UKCA, ATEX, UL/cUL, Class I Division 2, KC, KCs, and maritime certifications [ABS/BV/DNV/LR/NK/RINA]), please contact your local sales office.

Performance specifications

Item	Specifications	
	GS2110-WTBD-N	GS2107-WTBD-N
Display section *1 *2	Display device	TFT color LCD
	Screen size	10" widescreen
	Resolution	7" widescreen
	Display size	WVGA: 800 × 480 dots
	Number of displayed characters	W222(8.74) × H132.5(5.22) [mm] (inch)
	Display color	W154(6.06) × H85.9(3.38) [mm] (inch)
	Brightness adjustment	16-dot standard font: 50 characters × 30 lines (two-byte characters) 12-dot standard font: 66 characters × 40 lines (two-byte characters)
	Backlight *4	65536 colors
Touch panel *3 *9	Type	32 levels
	Key size	LED (not replaceable)
	Simultaneous press	Analog resistive film
	Life	Minimum 2 × 2 dots *7 (per key) Not available *5 (Only 1 point can be touched.)
Panel color	1 million touches or more (operating force: 0.98 N or less)	
User memory	User memory capacity	Black
	Life (number of write times)	Memory for storage (ROM) *10: 15 MB
		100000 times
Built-in interface	RS-232	1 channel Transmission speed: 115200, 57600, 38400, 19200, 9600, 4800 bps Connector shape: D-sub 9-pin (male)
	RS-422/485	1 channel Transmission speed: 115200, 57600, 38400, 19200, 9600, 4800 bps Connector shape: D-sub 9-pin (female) Terminating resistor: 330 Ω, 110 Ω, OPEN (Selectable by the terminating resistor setting switch.)
	Ethernet	1 channel Data transfer method: 100BASE-TX, 10BASE-T Connector shape: RJ45 (modular jack) AUTO MDI/MDI-X
	USB (device)	1 channel (rear face)
	SD memory card *10	USB version: USB 1.1 (Full-Speed 12 Mbps), Connector shape: USB Mini-B
Buzzer output	1 channel, SDHC compliant (maximum 32 GB)	
Protective structure *6	Single tone (tone length adjustable)	
Safety standards, radio laws (as of June 2023)	Front: IP65F *8	
External dimensions	272(10.71) (W) × 214(8.43) (H) × 56(2.21) (D) mm(inch)	206(8.11) (W) × 155(6.11) (H) × 50(1.97) (D) mm(inch)
Panel cut dimensions	258(10.16) (W) × 200(7.88) (H) mm(inch)	191(7.52) (W) × 137(5.40) (H) mm(inch)
Weight (excluding a fitting)	1.3(2.9) kg(lb)	0.9(2.0) kg(lb)
Compatible software package	GT Works3 Version 1.270G or later	

- *1 As a characteristic of liquid crystal display panels, bright dots (always lit) and dark dots (never lit) may appear on the panel. Since liquid crystal display panels comprise a great number of display elements, the appearance of bright and dark dots cannot be reduced to zero. Individual differences in liquid crystal display panels may cause differences in color, uneven brightness and flickering. Note that these phenomena are characteristics of liquid crystal display panels and it does not mean the products are defective or damaged.
- *2 Flickering may occur due to vibration, shock, or the display colors.
- *3 When a stylus is used, the touch panel has a life of 100 thousand touches. The stylus must satisfy the following specifications.
 - Material: polyacetal resin
 - Tip radius: 0.8 mm or more
- *4 To prevent the display section from burning in and lengthen the backlight life, enable the screen save function and turn off the backlight.
- *5 If you touch two points or more simultaneously on the touch panel, a switch in an unintended location may operate. Do not touch two points or more simultaneously on the touch panel.
- *6 Note that the structure does not guarantee protection in all users' environments. The GOT may not be used in certain environments where it is subjected to splashing oil or chemicals for a long period of time or soaked in oil mist.
- *7 The minimum size of a key that can be arranged. To ensure safe use of the product, the following settings are recommended.
 - Key size: 16 × 16 dots or larger
 - Distance between keys: 16 dots or more
- *8 The suffix "F" of IP65F is a symbol that indicates protection rate against oil. It is described in the Appendix of Japanese Industrial Standard JIS C 0920.
- *9 Repeatedly touching the outer edge of the actual display area may cause the product to fail.
- *10 While writing data to the memory for storage (ROM) or an SD memory card, if GOT is powered off, the data may be corrupted which may cause the GOT to stop operating.

Power supply specifications

Item	Specifications	
	GS2110-WTBD-N	GS2107-WTBD-N
Power supply voltage	24 V DC (+10%, -15%), ripple voltage 200 mV or less	
Power consumption	Under the maximum load	7.6 W (317 mA/24 V) or less
	Main unit (backlight OFF)	3.8 W (158 mA/24 V) or less
Inrush current	17 A or less (6 ms, ambient temperature 25°C, under the maximum load)	
Permissible instantaneous power failure time	Within 5 ms	
Noise immunity	Conforms to IEC61000-4-4, 2 kV (power supply line)	
Withstand voltage	350 V AC for 1 minute across power terminals and earth	
Insulation resistance	500 V DC across power terminals and earth, 10 MΩ or more by an insulation resistance tester	

Specifications

GT27 model/GT25 model

* For the external dimensions and panel cut dimensions of GT25 wide models, GT25 handy GOT, and GT25 rugged model, please refer to pages 158 and 159.

External dimensions

Unit: mm (inch)

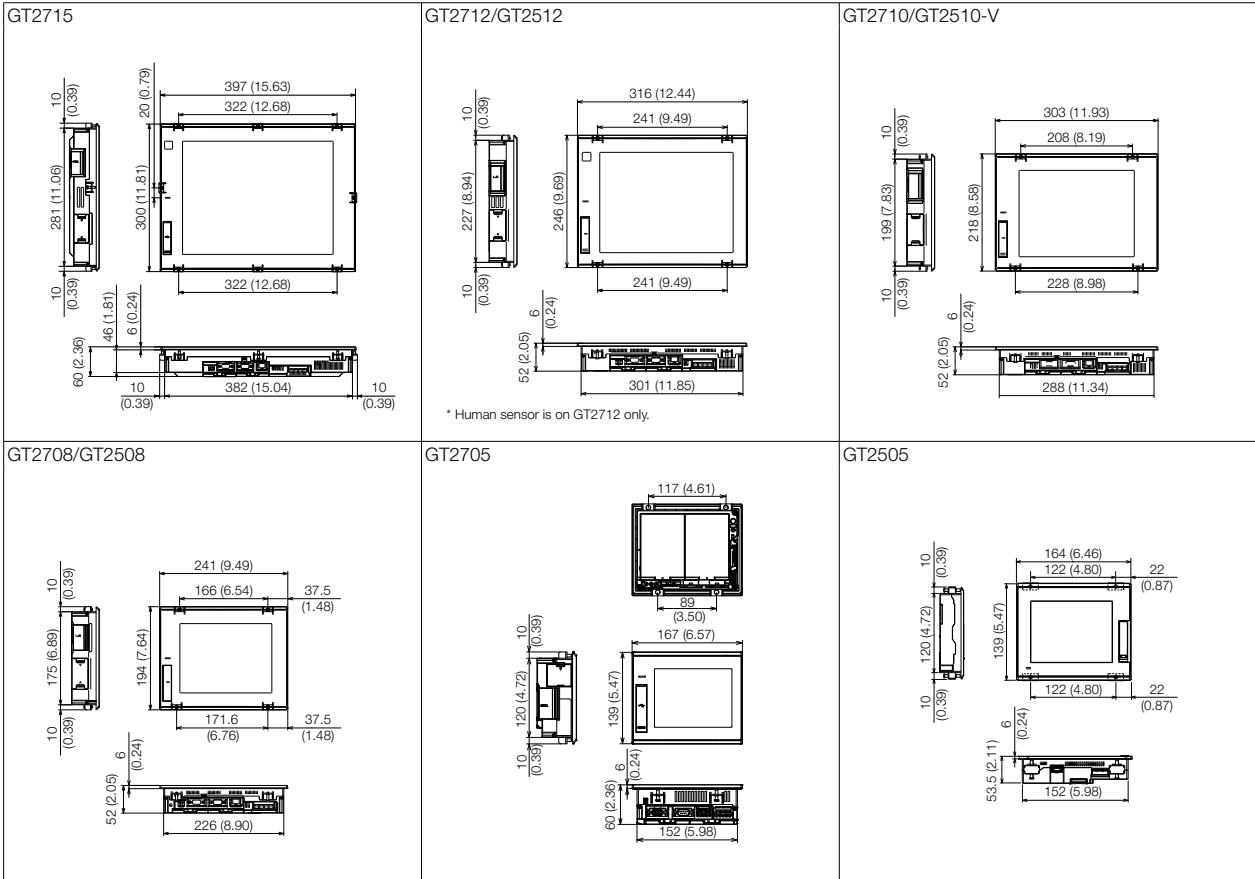

Panel cut dimensions

Unit: mm (inch)

Screen size	Model	A	B	Remarks
15"	GT2715	383.5 (15.10)	282.5 (11.12)	Same dimensions as GT1695, GT1595.
12.1"	GT2712 GT2512	302 (11.89)	228 (8.98)	Same dimensions as GT1685, GT1585, A985GOT.
10.4"	GT2710 GT2510-V	289 (11.38)	200 (7.87)	Same dimensions as GT167□, GT157□, GT1275, A97□GOT.
8.4"	GT2708 GT2508	227 (8.94)	176 (6.93)	Same dimensions as GT166□, GT156□, GT1265.
5.7"	GT2705 GT2505	153 (6.02)	121 (4.76)	Same dimensions as GT1655, GT155□, GT145□, GT115□, GT105□, F940GOT.

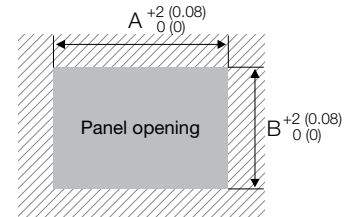

* Panel thickness: 1.6 mm to 4 mm
(0.06 inch to 0.16 inch)

GT25 open frame model

External dimensions

Unit: mm (inch)

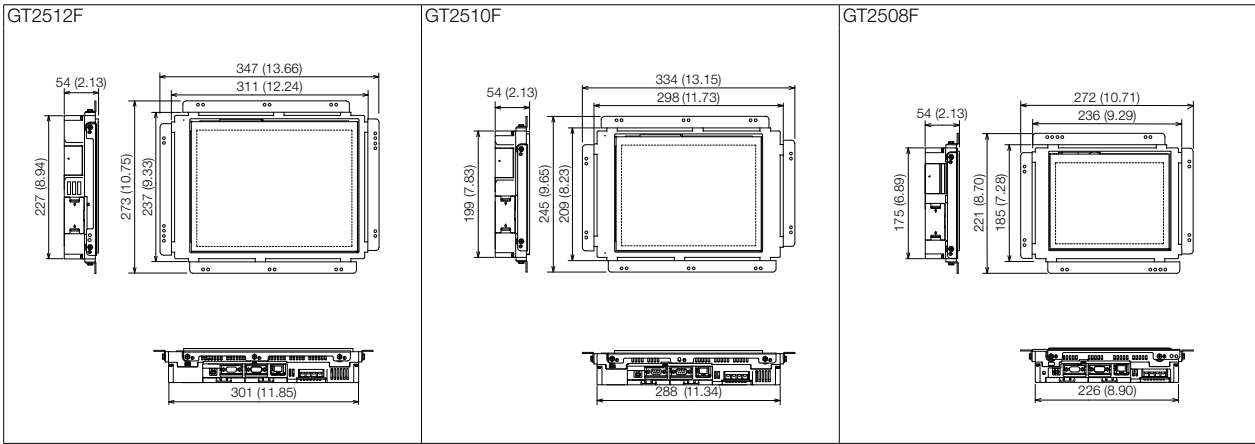

* Install the fittings on the top and bottom, or the right and left of the GOT.

Panel cut dimensions/Measurements based on the screen center

Unit: mm (inch)

Screen size	Model	Panel cutting dimensions		Measurements based on the screen center			
		X	Y	X1	X2	Y1	Y2
12.1"	GT2512F	214(8.43) (+2(0.08), 0(0))	269(10.59) (+2(0.08), 0(0))	103(4.06) (+2(0.08), 0(0))	(111(4.37))	134.5(5.30) (+1(0.04), 0(0))	(134.5(5.30))
10.4"	GT2510F	187(7.36) (+2(0.08), 0(0))	234(9.21) (+2(0.08), 0(0))	89.5(3.52) (+1(0.04), 0(0))	(97.5(3.84))	117(4.61) (+1(0.04), 0(0))	(117(4.61))
8.4"	GT2508F	158(6.22) (+2(0.08), 0(0))	194(7.64) (+2(0.08), 0(0))	75.25(2.96) (+1(0.04), 0(0))	(82.75(3.26))	97.5(3.84) (+1(0.04), 0(0))	(96.5(3.80))

Screen size	Model	Distance between studs *				
		A1	A2	A3	B1	B2
12.1"	GT2512F	98(3.86)± 0.15(0.01)	113(4.45)± 0.15(0.01)	7.5(0.30)± 0.15(0.01)	75.5(2.97)± 0.15(0.01)	79.5(3.13)± 0.15(0.01)
10.4"	GT2510F	105.5(4.15)± 0.15(0.01)	105.5(4.15)± 0.15(0.01)	0(0)	58(2.28)± 0.15(0.01)	58(2.28)± 0.15(0.01)
8.4"	GT2508F	64.5(2.54)± 0.15(0.01)	74.5(2.93)± 0.15(0.01)	—	58(2.28)± 0.15(0.01)	58(2.28)± 0.15(0.01)

Screen size	Model	Distance between studs *				
		C1	C2	C3	C4	C5
12.1"	GT2512F	98(3.86)± 0.15(0.01)	113(4.45)± 0.15(0.01)	7.5(0.30)± 0.15(0.01)	160(6.30)± 0.15(0.01)	175(6.89)± 0.15(0.01)
10.4"	GT2510F	105.5(4.15)± 0.15(0.01)	105.5(4.15)± 0.15(0.01)	0(0)	161(6.34)± 0.15(0.01)	161(6.34)± 0.15(0.01)
8.4"	GT2508F	64.5(2.54)± 0.15(0.01)	74.5(2.93)± 0.15(0.01)	—	126(4.96)± 0.15(0.01)	134(5.28)± 0.15(0.01)

Screen size	Model	Distance between studs *			
		D1	D2	D3	D4
12.1"	GT2512F	128.5(5.06)± 0.15(0.01)	132.5(5.22)± 0.15(0.01)	75.5(2.97)± 0.15(0.01)	79.5(3.13)± 0.15(0.01)
10.4"	GT2510F	114.5(4.51)± 0.15(0.01)	118.5(4.67)± 0.15(0.01)	58(2.28)± 0.15(0.01)	58(2.28)± 0.15(0.01)
8.4"	GT2508F	104.5(4.11)± 0.15(0.01)	104.5(4.11)± 0.15(0.01)	58(2.28)± 0.15(0.01)	58(2.28)± 0.15(0.01)

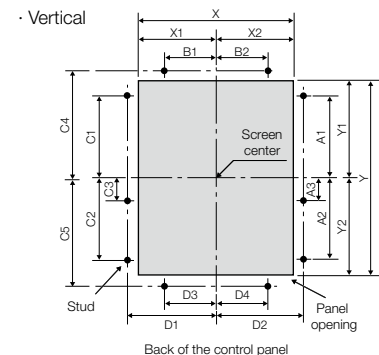
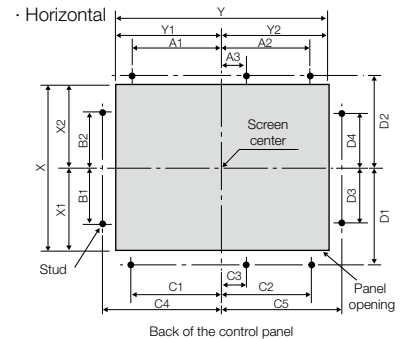

* Panel thickness: 1.5 mm to 4 mm
(0.06 inch to 0.16 inch)

* To mount the GOT on the control panel, studs are necessary. Align the studs with the installation holes of the fittings, and install the studs. The fittings must be installed on the top and bottom, or the right and left of the GOT. For GT2512F, you are recommended to install the fittings on the long sides of the GOT.

Specifications

GT25 wide model

External dimensions

Unit: mm (inch)

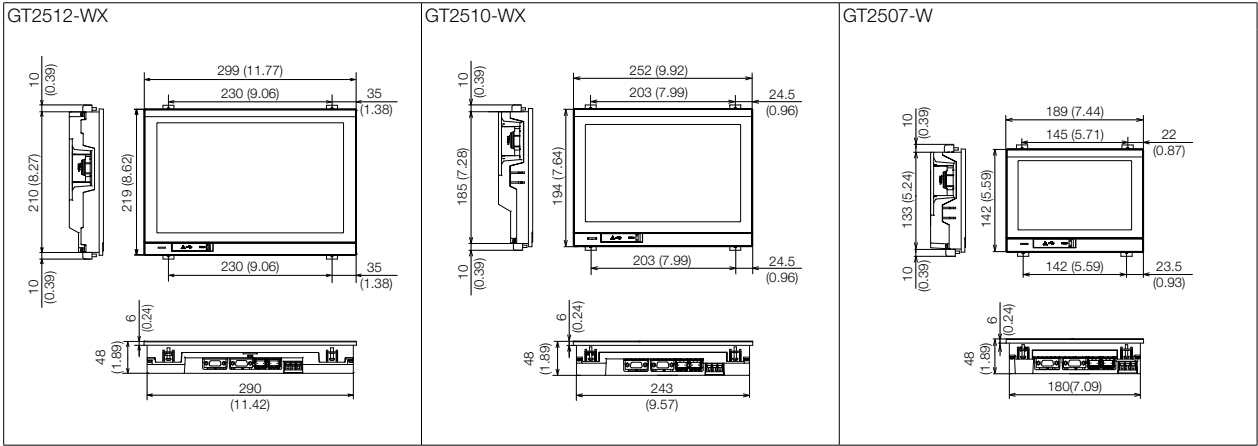

Panel cut dimensions

Unit: mm (inch)

Screen size	Model	A	B	Remarks
12.1" widescreen	GT2512-WX	290.5 (11.44)	210.5 (8.29)	—
10.1" widescreen	GT2510-WX	243.5 (9.59)	185.5 (7.30)	—
7" widescreen	GT2507-W	180.5 (7.11)	133.5 (5.26)	—

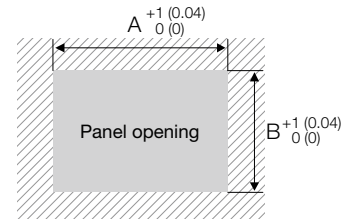

* Panel thickness: 1.6 mm to 4 mm (0.06 inch to 0.16 inch)



Specifications

GT25 handy GOT

External dimensions

Unit: mm (inch)

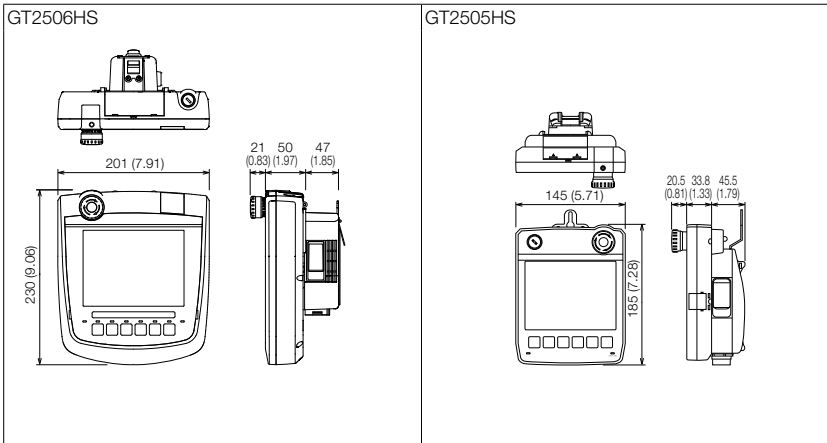

GT25 rugged model

External dimensions

Unit: mm (inch)

GT2507T-W

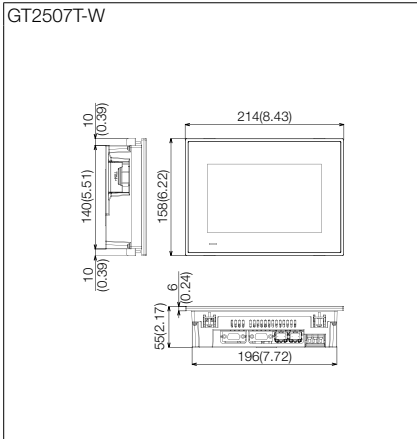

Panel cut dimensions

Unit: mm (inch)

Screen size	Model	A	B	Remarks
7" widescreen	GT2507T-W	197 (7.76)	141 (5.55)	—

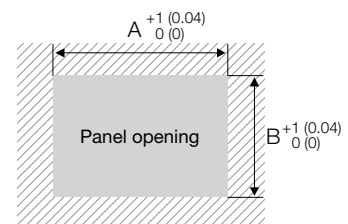

* Panel thickness: 1.6 mm to 4 mm
(0.06 inch to 0.16 inch)

GT23 model

External dimensions

Unit: mm (inch)

GT2310

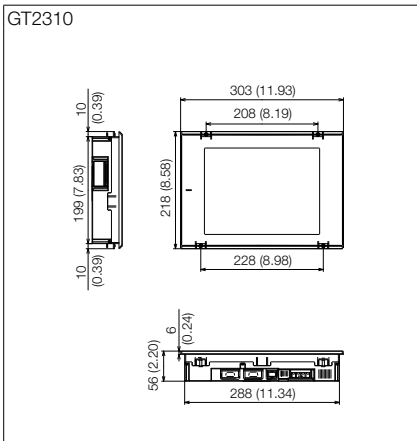

GT2308

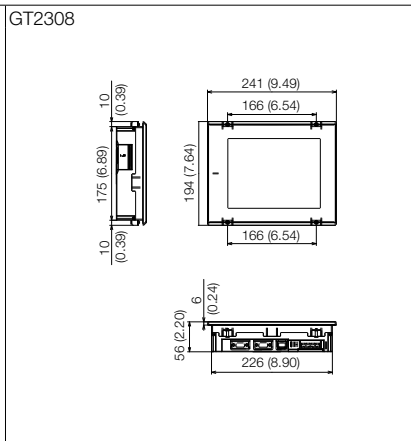

Panel cut dimensions

Unit: mm (inch)

Screen size	Model	A	B	Remarks
10.4"	GT2310	289 (11.38)	200 (7.87)	Same dimensions as GT167□, GT157□, GT1275, A97□GOT.
8.4"	GT2308	227 (8.94)	176 (6.93)	Same dimensions as GT166□, GT156□, GT1265.

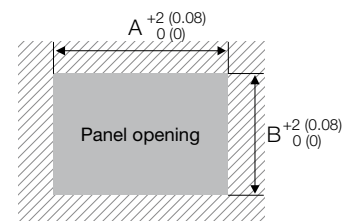

* Panel thickness: 1.6 mm to 4 mm
(0.06 inch to 0.16 inch)

Specifications

GT21 wide model

External dimensions

Unit: mm (inch)

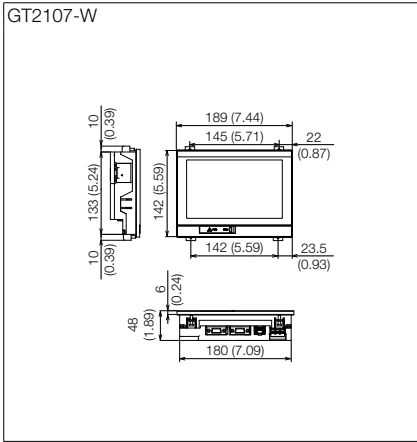

Panel cut dimensions

Unit: mm (inch)

Screen size	Model	A	B	Remarks
7" widescreen	GT2107-W	180.5 (7.11)	133.5 (5.26)	—

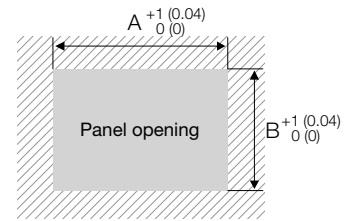

* Panel thickness: 1.6 mm to 4 mm
(0.06 inch to 0.16 inch)

GT21 model

External dimensions

Unit: mm (inch)

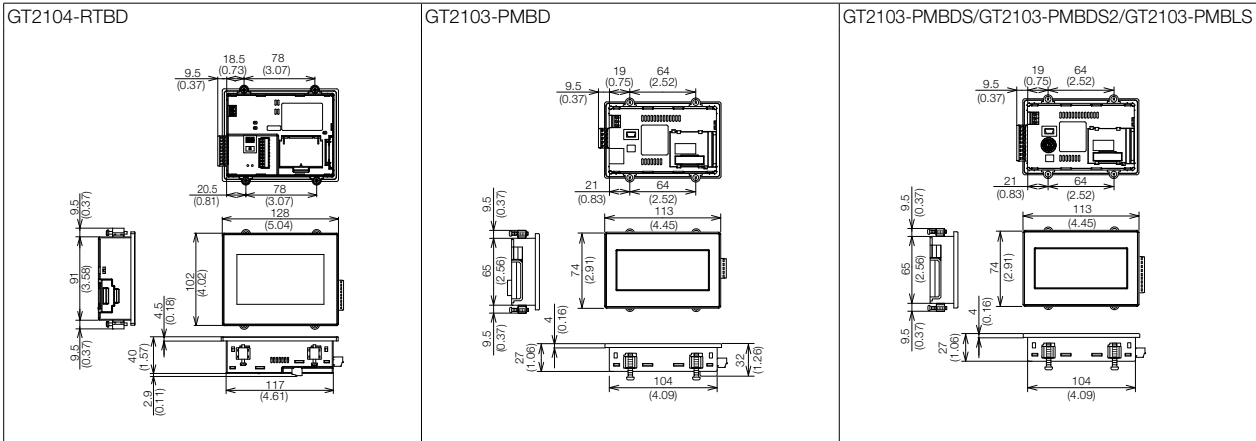

Panel cut dimensions

Unit: mm (inch)

Screen size	Model	A	B	Remarks
4.3"	GT2104	118 (4.65)	92 (3.62)	—
3.8"	GT2103	105 (4.13)	66 (2.60)	Same dimensions as GT1020.

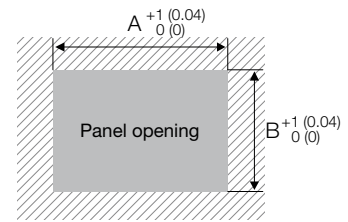

* Panel thickness: 1 mm to 4 mm
(0.04 inch to 0.16 inch)

GS21 model

External dimensions

Unit: mm (inch)

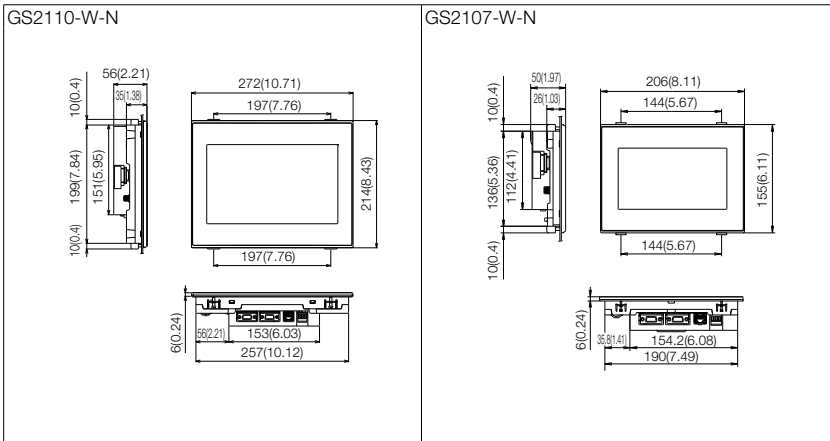

Panel cut dimensions

Unit: mm (inch)

Screen size	Model	A	B	Remarks
10" widescreen	GS2110-W-N	258 (10.16)	200 (7.88)	—
7" widescreen	GS2107-W-N	191 (7.52)	137 (5.40)	—

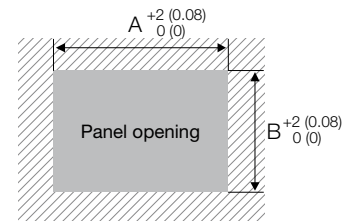

* Panel thickness: 1.6 mm to 4 mm
(0.06 inch to 0.16 inch)

Specifications

Communication cable

External dimensions

RS-232 connection cable connector

Cable model	Cable length (m(ft.))	External dimensions
GT01-C30R2-6P	3(10)	(1)
GT01-C30R2-9S	3(10)	(2)
GT01-C30R2-25P	3(10)	(3)
GT10-C30R2-6P	3(10)	(4)

Unit: mm (inch)

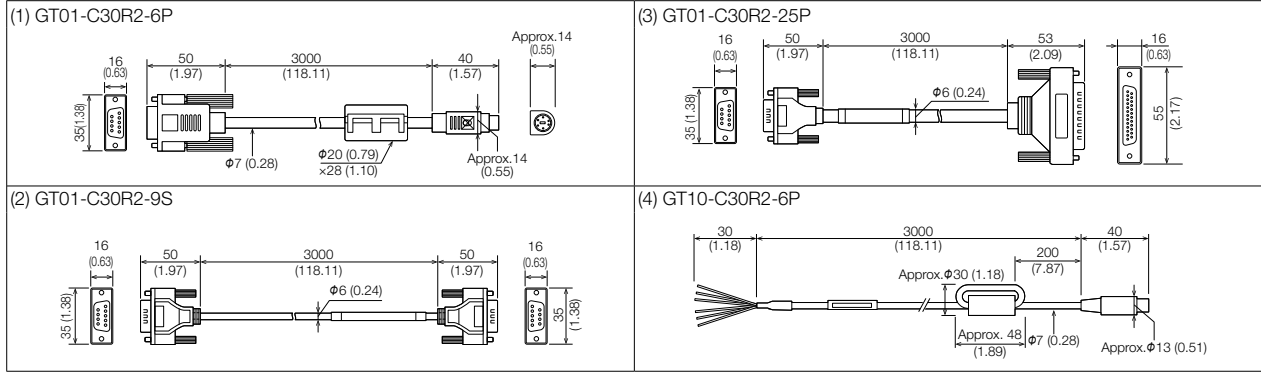

RS-422 connection cable connector

Cable model	Cable length (m(ft.))	External dimensions
GT01-C30R4-25P	3(10)	(1)
GT01-C□R4-25P	10(33), 20(66), 30(98)	(2)
GT01-C□R4-8P	1(3), 3(10), 10(33), 20(66), 30(98)	(3)
GT10-C□R4-8P	1(3), 3(10), 10(33), 20(66), 30(98)	(4)
GT10-C□R4-25P	3(10), 10(33), 20(66), 30(98)	(5)

Cable model	Cable length (m(ft.))	External dimensions
GT21-C□R4-8P5	1(3), 3(10), 10(33), 20(66), 30(98)	(4)
GT21-C□R4-25P5	3(10), 10(33), 20(66), 30(98)	(5)
GT10-C10R4-8PL	1(3)	(6)
GT10-C□R4-8PC	1(3), 3(10), 10(33), 20(66), 30(98)	(7)
GT10-C02H-9SC	0.2(0.7)	(8)

Unit: mm (inch)

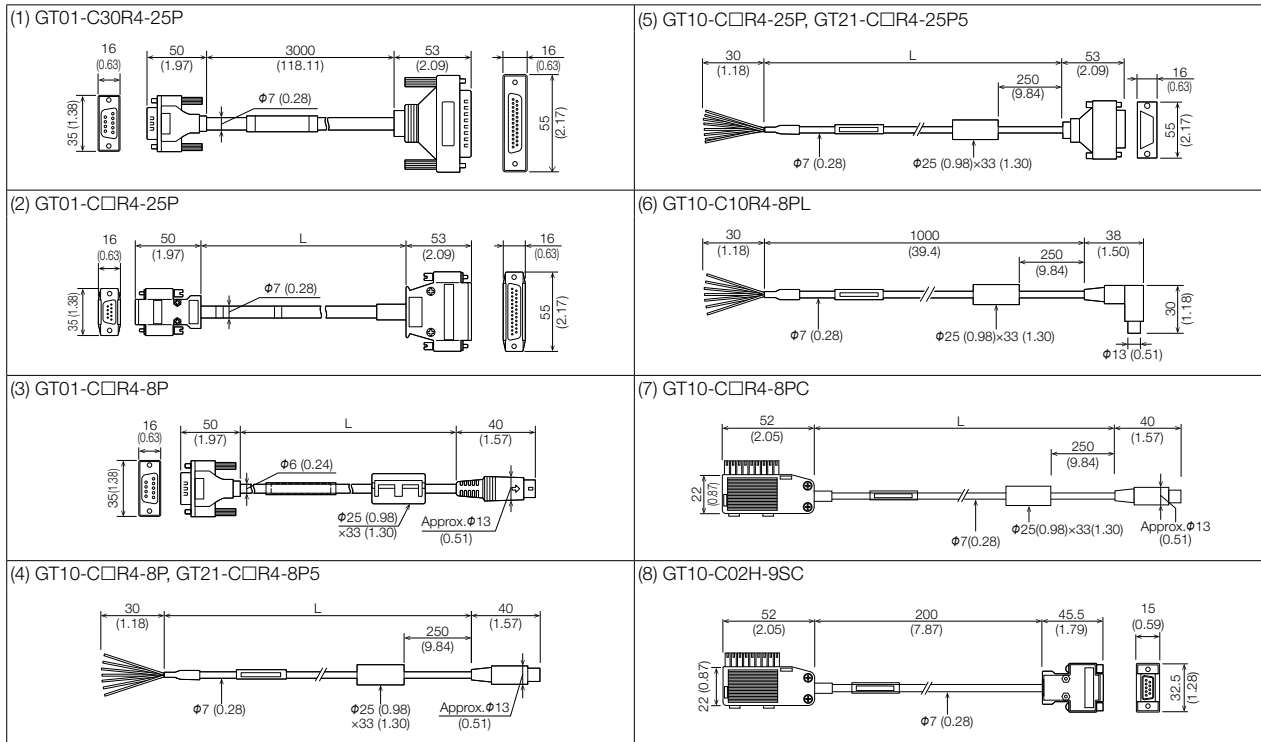

■ RS-485 terminal block conversion unit

Cable model	Cable length (m(ft.))	External dimensions
FA-LTBGT2R4CBL□	0.5(1.6), 1(3.3), 2(6.6)	(1)

Unit: mm (inch)

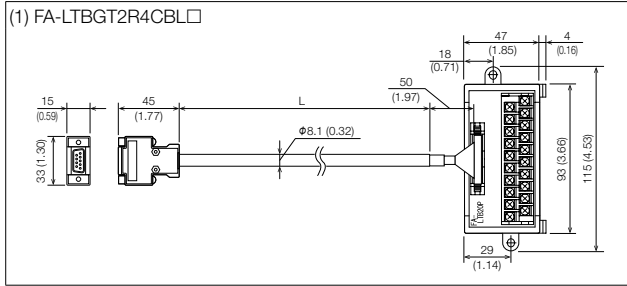

■ Connection cable for Handy GOT

Cable model	Cable length (m(ft.))	External dimensions
GT16H-C□□□-42P	3(10), 6(20), 10(33)	(1)
GT16H-C□□□-37PE	3(10), 6(20), 10(33)	(2)
GT14H-C□□□-42P	3(10), 6(20), 10(33)	(3)
GT11H-C□□□-37P	3(10), 6(20), 10(33)	(4)

Cable model	Cable length (m(ft.))	External dimensions
GT11H-C□□□	3(10), 6(20), 10(33)	(5)
GT11H-C15R4-8P	15(49)	(6)
GT11H-C15R4-25P	15(49)	(7)
GT11H-C15R2-6P	15(49)	(8)

Unit: mm (inch)

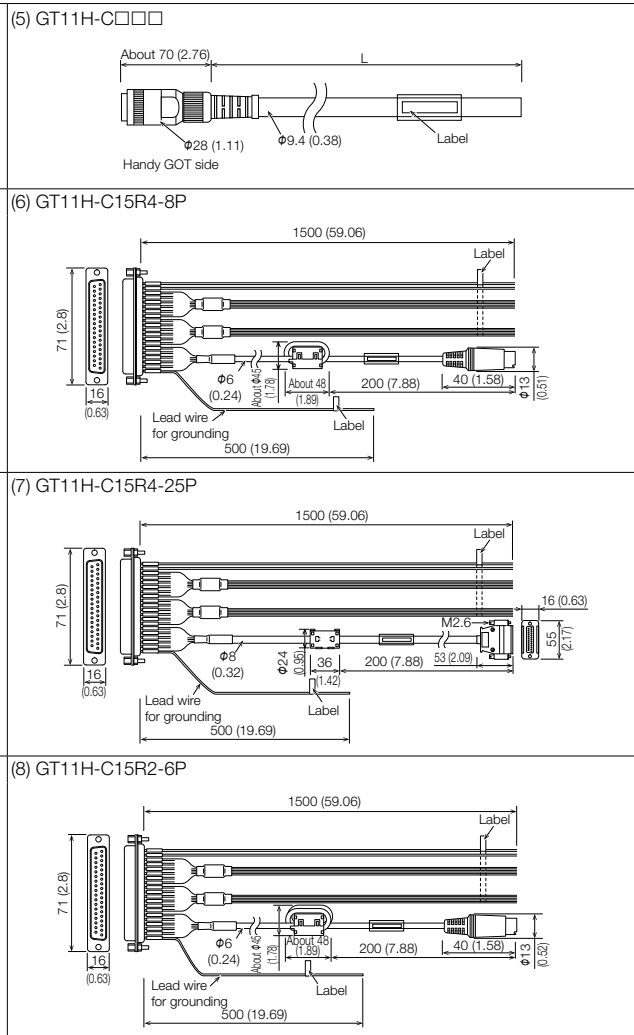
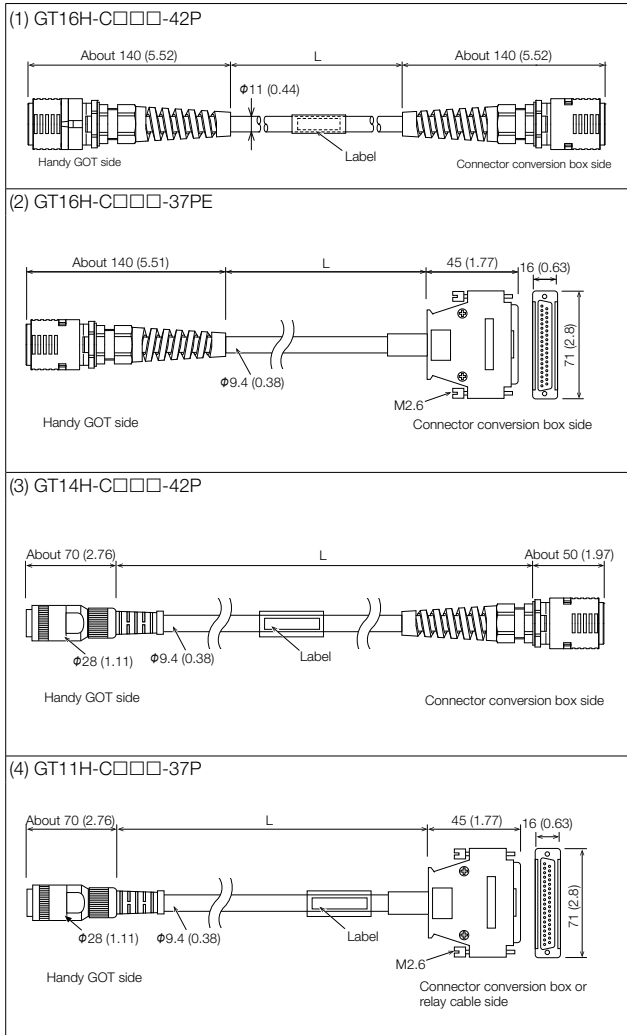

Specifications

Operating environment

MELSOFT GT Works3 Version1 (English Version) operating environment

Item	Description
Personal computer	Personal computer that Windows® runs on.
OS (English, Simplified Chinese, Traditional Chinese, Korean, German, or Italian version) *1 *2 *3 *4 *5 *6 *7	Microsoft® Windows® 11 (Enterprise, Pro, Home, Education) (64bit) Microsoft® Windows® 10 (Enterprise, Pro, Home) (64bit/32bit) Microsoft® Windows® 10 (IoT Enterprise 2016 LTSB) (64 bit) (English OPK, or English OPK and a language pack for localization)
CPU	Windows® 11: 64 bit-compatible processor with dual-core or more or System on a Chip (SoC) *8 Other than Windows® 11: Intel® Core™ 2 Duo Processor 2.0 GHz or more recommended *8
Memory	For Windows® 11: 4 GB or more recommended For 64-bit OS other than Windows® 11: 2 GB or more recommended For 32-bit OS other than Windows® 11: 1 GB or more recommended
Display	Resolution XGA (1024 x 768 dots) or higher
Hard disk space	For installation: 5 GB or more recommended For execution: 512 MB or more recommended
Display color	High Color (16 bits) or higher
Other hardware	Use the hardware compatible with the above OS. <ul style="list-style-type: none"> • For installation: mouse, keyboard, DVD drive • For execution: mouse, keyboard • For printing: printer Use the following hardware when required. <ul style="list-style-type: none"> • For simulation (only when outputting the buzzer sound): sound card, speaker
Compatible GOT	GOT2000 Series, GOT1000 Series
Applicable software version	GT Works3 Version1.295H or later

- *1 For installation, administrator privileges are required.
For startup, the standard user or administrator account is required. To use GT Designer3 with another MELSOFT application that runs with administrator privileges, run GT Designer3 with administrator privileges.
If you change any setting of the personal computer while GT Designer3 is running, the change will not be applied to GT Designer3.
- *2 The following functions are not supported.
 - Application start in Windows compatibility mode
 - Fast user switching
 - Change your desktop themes (fonts)
 - Remote desktop
 - Setting the size of text and illustrations on the screen to any size other than [Small-100%]
- *3 Operation is not supported in an environment with text cursor indicator turned on.
- *4 The touch feature is not supported.
- *5 Operation in a virtual environment such as Hyper-V is not supported.
- *6 Tablet mode is not supported.
- *7 Unified Write Filter is not supported.
- *8 The ARM64 and ARM32 are not supported.



GT SoftGOT2000 Version1 (English Version) operating environment

Item	Description
Personal computer	Personal computer that Windows® runs on. MELIPC (MI5122-VW, MI3321G-W ^{*10} , MI3315G-W ^{*10} , MI2012-W, MI2012-W-CL) ^{*11}
OS (English, Simplified Chinese, Traditional Chinese, Korean, German, or Italian version) ^{*1 2 3 4}	Microsoft® Windows Server® 2019 (Standard) (64bit) ^{*12 *13 *14} Microsoft® Windows Server® 2016 (Standard) (64 bit) ^{*12 *13} Microsoft® Windows® 11 (Enterprise, Pro, Home, Education) (64bit) ^{*8 *12 *13} Microsoft® Windows® 10 (Enterprise, Pro, Home) (64bit/32bit) ^{*12 *13} Microsoft® Windows® 10 IoT Enterprise 2019 LTSC (64 bit) (English OPK, or English OPK and a language pack for localization) ^{*7 *8 *12 *13} Microsoft® Windows® 10 IoT Enterprise 2016 LTSC (64 bit) (English OPK, or English OPK and a language pack for localization) ^{*7 *8 *12 *13}
CPU	Windows® 11: 64 bit-compatible processor with dual-core or more or System on a Chip (SoC) ^{*15} Other than Windows® 11: Intel Core™ 2 Duo Processor 2.0 GHz or more recommended ^{*15}
Memory	For Windows® 11: 4 GB or more recommended For 64-bit OS other than Windows® 11: 2 GB or more recommended For 32-bit OS other than Windows® 11: 1 GB or more recommended
Display	Resolution XGA (1024 x 768 dots) or higher
Hard disk space ^{*5}	For installation: 5 GB or more recommended For execution: 512 MB or more recommended
Display color	High Color (16 bits) or higher
Hardware	GT27-SGTKEY-U (license key (for USB port))
Other software	The following software is required to create the project data. <ul style="list-style-type: none"> GT Designer3 Version1.100E or later^{*6 *9} The following software is required for interaction with PX Developer. <ul style="list-style-type: none"> PX Developer Version1.40S or later GT Designer3 Version1.105K or later^{*6} The following software is required to connect with GX Simulator. <ul style="list-style-type: none"> GX Simulator Version5.00A or later The following software is required to connect with GX Simulator2. <ul style="list-style-type: none"> GX Works2 Version1.12N or later The following software is required to connect with GX Simulator3. <ul style="list-style-type: none"> GX Works3 Version1.007H or later The following software is required to connect with MT Simulator2. <ul style="list-style-type: none"> MT Works2 Version1.70Y or later The following software is required to use the OPC UA client connection. <ul style="list-style-type: none"> GT OPC UA Client
Other hardware	Use the hardware compatible with the above OS. <ul style="list-style-type: none"> For installation: mouse, keyboard, DVD drive For execution: mouse, keyboard For printing: printer Prepare the following hardware if necessary. <ul style="list-style-type: none"> For execution (only when outputting buzzer sound or others): sound function, speaker

- ^{*1} Administrator authority is required for installing and using GT SoftGOT2000.
If you use GT SoftGOT2000 and other MELSOFT products simultaneously on the same personal computer, run the MELSOFT products with administrator authority as well.
- ^{*2} The following functions are not supported.
 - Activating the application with Windows compatibility mode
 - Fast user switching
 - Change your desktop themes (fonts)
 - Remote desktop
 - Setting the size of text and illustrations on the screen to any size other than [Small-100%]
- ^{*3} Tap and press-and-hold features are supported. As operations such as flicking are not supported, the following operations are unavailable accordingly.
 - Touching two touch switches simultaneously.
 - Moving an overlap window or key window by a slide operation. When [Allow press-and-hold of a mouse button to function as a right-click] is selected in the [Environment Setup] dialog of GT SoftGOT2000, the following operations are also unavailable.
 - Touching a touch switch ([Action]: [Momentary])
 - Touching a touch switch ([Delay]: [ON])
 - Touching the utility call key
- ^{*4} Operation in a virtual environment such as Hyper-V is not supported.
- ^{*5} When using GT Designer3 or PX Developer besides GT SoftGOT2000, additional free space is required.
For the available space required when using GT Designer3, please refer to the GT Works3 operating environment.
For the available space required when using monitor tool functions of PX Developer, please refer to the following manual.
→ PX Developer Version □ Operating Manual (Monitor Tool)
When using a user-created application, free space is required separately.
- ^{*6} Use GT Designer3 included in GT Works3 that contains GT SoftGOT2000.
- ^{*7} The following OSs are not supported.
 - Microsoft® Windows® 10 IoT Enterprise for Retail or Thin Client
 - Microsoft® Windows® 10 IoT Enterprise for Tablets
 - Microsoft® Windows® 10 IoT Enterprise for Small Tablets
- ^{*8} The following lockdown features are not supported.
 - Unified Write Filter
 - Assigned Access
 - USB Filter
 - Layout Control
 - AppLocker
 - Shell Launcher
 - Text cursor indicator
- ^{*9} To use the Edgecross interaction function, Version1.195D or later is required.
- ^{*10} GT SoftGOT2000 (English version) is preinstalled.
- ^{*11} Microsoft® Windows® 10 IoT Enterprise 2016 LTSC is preinstalled. For the specifications of the MELIPC, refer to the following.
 - MELIPC MI5000 Series User's Manual (Startup)
 - MELIPC MI3000 User's Manual
 - MI2012-W User's Manual
- ^{*12} Disable high-speed startup.
If enabled, GT SoftGOT2000 may not operate properly when the personal computer is shut down and then started.
- ^{*13} Some digital pens are unusable.
- ^{*14} Only Desktop Experience is available.
- ^{*15} ARM64 and ARM32 are not supported.



Specifications

Function list

For the details of functions, supported controllers, and connection types, please refer to the relevant manual or Help of the GOT2000/GOT SIMPLE Series.
●: Supported —: Not supported

Category	Function name	Necessary devices *1	GT27	GT25	GT25 Wide	GT25 Handy	GT25 Rugged	
Hardware specifications	Screen size							
	Resolution							
	Color	65536 colors		●	●	●	●	●
		Monochrome (black/white) 32 shade grayscale		—	—	—	—	—
	Memory	Memory for storage (ROM)	Other than below: 57 MB GT2705: 32 MB	—	32 MB	32 MB	32 MB	32 MB
		Memory for operation (RAM)	Other than below: 256 MB *22 GT2705: 80 MB	—	80 MB	128 MB	80 MB	128 MB
	Interface	RS-232		●	●	●	●	●
		RS-422/485		●	●	●	GT2505HS supports RS-422 only	●
	Human sensor	Ethernet	(Ethernet communication unit)	● 2 ports by installing communication unit	● 2 ports by installing communication unit *17	● 2 ports as standard	●	● 2 ports as standard
		USB host		●	●	●	●	●
	Human sensor	USB device		●	●	●	●	●
		SD memory card interface		●	●	●	●	●
	Human sensor	Extension interface, Side interface, Wireless LAN communication unit interface	Communication units, option units	● *11	● *11 *17	● *11	—	● *11
		Figure/object functions		●	●	●	●	●
	Screen design	Figure		●	●	●	●	●
		Logo text		●	●	●	●	●
	Screen design	Outline font		●	●	●	●	●
		Touch switch		●	●	●	●	●
	Screen design	Lamp		●	●	●	●	●
		Numerical display, Numerical input		●	●	●	●	●
	Screen design	Text display, Text input		●	●	●	●	●
Date display, Time display		(Battery)	●	●	●	●	●	
Screen design	Comment display		●	●	●	●	●	
	Parts display	(SD memory card or USB memory)	●	●	●	●	●	
Screen design	Parts movement	(SD memory card or USB memory)	●	●	●	●	●	
	Historical data list display	(SD memory card or USB memory)	●	●	●	●	●	
Screen design	Simple alarm display		●	●	●	●	●	
	System alarm display		●	●	●	●	●	
Screen design	Alarm display (user)	(SD memory card or USB memory, battery)	●	●	●	●	●	
	Alarm display (system)	(SD memory card or USB memory, battery)	●	●	●	●	●	
Screen design	Recipe display (record list)		●	●	●	●	●	
	Line graph		●	●	●	●	●	
Screen design	Trend graph		●	●	●	●	●	
	Bar graph		●	●	●	●	●	
Screen design	Statistic bar graph		●	●	●	●	●	
	Statistic pie graph		●	●	●	●	●	
Screen design	Scatter graph		●	●	●	●	●	
	Historical trend graph	(SD memory card or USB memory)	●	●	●	●	●	
Screen design	Graphical meter		●	●	●	●	●	
	Level		●	●	●	●	●	
Screen design	Panelmeter		●	●	●	●	●	
	Slider		●	●	●	●	●	
Screen design	Document display	SD memory card	●	●	●	●	●	
	Script parts		●	●	●	●	●	
Functions performed on background of GOT	Logging	(SD memory card or USB memory, battery)	●	●	●	●	●	
	Recipe	(SD memory card or USB memory, battery)	●	●	●	●	●	
Functions performed on background of GOT	Device data transfer		●	●	●	●	●	
	Trigger action		●	●	●	●	●	
Functions performed on background of GOT	Time action	(SD memory card or USB memory)	●	●	●	●	●	
	Hard copy	File output	(SD memory card or USB memory)	●	●	●	●	●
Serial printer output			●	●	●	—	●	
Ethernet printer output			●	●	●	—	●	
PictBridge printer output		Printer unit	●	● *17	—	—	—	
Functions performed on background of GOT	Project script, Screen script		●	●	●	●	●	
	Object script		●	●	●	●	●	

*1 Necessary units when using GT27, GT25, GT25 wide, GT25 handy, GT25 rugged, GT23, GT21 wide, GT21, or GS21 models are shown. Parenthesized devices are required depending on conditions of use.

*2 Data is output to the printer that is recognized by the personal computer.

*3 CSV files are saved in the virtual drive of the personal computer so that it is recommended to output the files to printers.

*4 Only the GOTs with SVGA or higher resolution are supported.

*5 Remote personal computer operation function (Ethernet) cannot be used. The following screens are displayed horizontally: utility screen, monitor and data management screens that are displayed from the utility screen (sequence program monitor, etc.), video camera images in the multimedia and video display functions. For the details of other GOT operations when placed vertically, please refer to the relevant product manual or Help.

*6 Excluding GT2103-PMBLS.

*7 GT2104-RTBD only.

*8 Excluding GT2705-VTBD.

Specifications

For the details of functions, supported controllers, and connection types, please refer to the relevant manual or Help of the GOT2000/GOT SIMPLE Series.
 ●: Supported —: Not supported

Category	Function name	Necessary devices *1	GT23	GT21 Wide	GT21	GS21-W-N NEW	GT SoftGOT2000	
Screen size	15"		—	—	—	—	Flexible resolution 640 to 1920 × 480 to 1200	
	12.1"		—	—	—	—		
	12.1" Wide	NEW	—	—	—	—		
	10.4"		●	—	—	—		
	10.1" Wide		—	—	—	—		
	10" Wide		—	—	—	●		
	8.4"		●	—	—	—		
	7" Wide		—	●	—	●		
	6.5"		—	—	—	—		
	5.7"		—	—	—	—		
	4.3"		—	—	●	—		
	3.8"		—	—	●	—		
	Resolution	WXGA 1280 × 800		—	—	—		—
		XGA 1024 × 768		—	—	—		—
		SVGA 800 × 600		—	—	—		—
		WVGA 800 × 480		—	●	—		●
		VGA 640 × 480		●	—	—		—
		Other		—	—	GT2104-R: 480 × 272 GT2103-P: 320 × 128		—
	Color	65536 colors		●	●	●		●
		Monochrome (black/white) 32 shade grayscale		—	—	●		—
	Hardware specifications	Touch panel simultaneous press (2 points)		—	—	—		—
Human sensor			—	—	—	—		
Memory		Memory for storage (ROM)		9 MB	15 MB	GT2104-R: 9 MB GT2103-P: 3 MB	15 MB NEW	57 MB
		Memory for operation (RAM)		9 MB	—	—	—	—
Interface		RS-232		●	●	● *20	●	● *12
		RS-422/485		●	●	● *20	● NEW	● *12
		Ethernet	(Ethernet communication unit)	●	●	● *20	●	● *11
		USB host		●	●	—	—	● *13
		USB device		●	●	●	●	—
		SD memory card interface		●	●	● *14	●	● *13
		Extension interface, Side interface, Wireless LAN communication unit interface	Communication units, option units	—	—	—	—	● *11
Screen design		Figure		●	●	●	●	●
		Logo text		●	●	●	●	●
		Outline font		●	●	—	● NEW	●
		Touch switch		●	●	●	●	●
		Lamp		●	●	●	●	●
		Numerical display, Numerical input		●	●	●	●	●
		Text display, Text input		●	●	●	●	●
	Date display, Time display	(Battery)	●	●	●	●	●	
	Comment display		●	●	●	●	●	
	Parts display	(SD memory card or USB memory)	●	●	● *16	●	●	
	Parts movement	(SD memory card or USB memory)	●	●	● *16	●	●	
	Historical data list display	(SD memory card or USB memory)	●	●	● *16	●	●	
	Simple alarm display		●	●	●	●	●	
	System alarm display		●	—	—	—	●	
	Alarm display (user)	(SD memory card or USB memory, battery)	●	●	● *16	●	●	
	Alarm display (system)	(SD memory card or USB memory, battery)	●	—	—	—	●	
	Recipe display (record list)		●	●	●	●	●	
	Line graph		●	●	●	●	●	
	Trend graph		●	●	●	●	●	
	Bar graph		●	●	●	●	●	
	Statistic bar graph		●	●	●	●	●	
	Statistic pie graph		●	●	●	●	●	
	Scatter graph		●	●	●	●	●	
	Historical trend graph	(SD memory card or USB memory)	●	●	● *16	●	●	
	Graphical meter		●	●	●	●	●	
	Level		●	●	●	●	●	
	Panelmeter		●	●	●	●	●	
Slider		●	●	●	●	●		
Document display	SD memory card	—	—	—	—	●		
Script parts		●	●	●	●	●		
Functions performed on background of GOT	Logging	(SD memory card or USB memory, battery)	●	●	● *16	●	●	
	Recipe	(SD memory card or USB memory, battery)	●	●	● *16	●	●	
	Device data transfer		●	●	●	●	●	
	Trigger action		●	●	●	●	●	
	Time action	(SD memory card or USB memory)	●	●	●	●	●	
	Hard copy	File output	(SD memory card or USB memory)	●	●	● *16	●	●
		Serial printer output		●	●	● *16	●	● *2
		Ethernet printer output		●	●	● *15	●	● *2
		PictBridge printer output	Printer unit	—	—	—	—	● *2
	Project script, Screen script		●	●	●	●	●	
Object script		●	—	—	—	●		

*9 To use multiple units such as extension units, barcode readers, or RFID controllers with a GT2705-VTBD, the total current consumption of the units should be less than the value that the GT2705-VTBD can provide. For the details, please refer to the relevant manual of the GOT2000 Series.
 *10 GT2715-XTBA, GT2715-XTBD, GT2712-STBA, GT2712-STBD, GT2712-STWA, GT2712-STWD only.
 *11 For the applicable communication units and option units, please refer to "Product list" (page 196) and the relevant product manual.
 *12 Use the standard interface of the personal computer.
 *13 When using functions that require a USB memory or SD memory card, a virtual drive in the personal computer is used.
 *14 GT2103-PMBD, GT2103-PMBDS, and GT2103-PMBDS2 require an SD memory card unit (GT21-03SDCD) separately. GT2103-PMBLS does not allow for SD memory cards.

*15 GT2104-RTBD, GT2103-PMBD only.
 *16 On GT2103-PMBLS, only the functions that do not require SD memory card can be used.
 *17 Excluding GT2505-VTBD.
 *18 GT25 wide and GT25 rugged models have a built-in sound output interface so that the sound output unit is not required.
 *19 GT2505HS-VTBD supports the function with Ethernet connection only.
 *20 GT21 has different interfaces depending on the model. For the details, please refer to the performance specifications on pages 152 and 153.
 *21 Only Ethernet, OPC UA client, and microcomputer connections are supported.
 *22 If the function version is B or earlier, the memory for operation (RAM) is 128 MB.
 *23 GT SoftGOT2000 supports the server function only.
 *24 It is recommended to use GT SoftGOT2000 (Multiple channels) for this function.

Specifications

Function list

For the details of functions, supported controllers, and connection types, please refer to the relevant manual or Help of the GOT2000/GOT SIMPLE Series.
 ●: Supported —: Not supported

Category	Function name	Necessary devices *1	GT27	GT25	GT25 Wide	GT25 Handy	GT25 Rugged	
Screen design	Barcode function		●	●	●	—	●	
	RFID function		●	●	●	—	●	
	GOT Mobile function	License, (SD memory card)	●	●	●	●	●	
	VNC server function	License	●	●	●	●	●	
	Remote personal computer operation function (Ethernet)	License	●	●	●	●	●	
	Remote personal computer operation function (serial)	RGB input unit or Video/RGB input unit	● *8	—	—	—	—	
	Video display function	Video input unit or Video/RGB input unit	● *8	—	—	—	—	
	RGB display function	RGB input unit or Video/RGB input unit	● *8	—	—	—	—	
	Multimedia function	Multimedia unit, CF card	● *8	—	—	—	—	
	External I/O function	External I/O unit	●	● *17	—	—	—	
	Operation panel function	External I/O unit	●	● *17	—	—	—	
	Video output function	HDMI output	Digital video output unit	● *8	—	—	—	—
		RGB output	RGB output unit	● *8	—	—	—	—
	Report function	File output	(SD memory card or USB memory)	●	●	●	●	●
		Serial printer output	(SD memory card or USB memory)	●	●	●	—	●
		Ethernet printer output	(SD memory card or USB memory)	●	●	●	●	●
		PictBridge printer output	SD memory card or USB memory, printer unit	●	● *17	—	—	—
	Sound output function	Sound output unit *18	●	● *17	● *18	—	● *18	
	Server function, Client function		●	●	●	●	●	
	Mail send function		●	●	●	●	●	
	Network drive function		●	●	●	●	●	
	FTP server function	(SD memory card or USB memory)	●	●	●	●	●	
	File transfer function (FTP transfer)	SD memory card or USB memory	●	●	●	●	●	
	File transfer function (GOT internal transfer)	SD memory card or USB memory	●	●	●	●	●	
	MES interface function	License, (SD memory card)	●	●	●	●	●	
	Wireless LAN function	Wireless LAN communication unit	●	● *17	—	—	●	
	USB mouse, USB keyboard		●	●	●	●	●	
	GOT functions	Base screen		●	●	●	●	●
		Overlap window		●	●	●	●	●
		Superimpose window		●	●	●	●	●
		Dialog window		●	●	●	●	●
		Mobile screen		●	●	●	●	●
Key window			●	●	●	●	●	
Language switching			●	●	●	●	●	
System information			●	●	●	●	●	
Operator authentication function		(SD memory card or USB memory)	●	●	●	●	●	
Operation log		SD memory card or USB memory	●	●	●	●	●	
Startup logo			●	●	●	●	●	
KANA KANJI conversion			●	●	●	●	●	
FA transparent			●	●	●	●	●	
SoftGOT-GOT link		License key	●	●	●	●	●	
Backup/Restoration		SD memory card or USB memory	●	●	●	●	●	
Multi-channel function			● *9 4 channels (Up to 3 units)	● 4 channels (Up to 3 units *17)	● 4 channels (No units can be mounted)	● *19 4 channels (No units can be mounted)	● 4 channels (No units can be mounted)	
Station No. switching			●	●	●	●	●	
GOT network interaction			●	●	●	●	●	
Screen gesture function			●	—	—	—	—	
Object gesture function			●	—	—	—	—	
Security key authentication function			●	●	●	●	●	
IP filter function			●	●	●	●	●	
File manager	(SD memory card or USB memory)	●	●	●	●	●		
Vertical display *5		● (Rotate 90 ° to left)	● (Other than below, rotate 90° to left GT250S: rotate 90° to right)	● (Rotate 90 ° to left)	—	● (Rotate 90 ° to left)		
Vision sensor monitor	NEW	●	●	●	●	●		
Device monitor	(SD memory card or USB memory)	●	●	●	●	●		
Sequence program monitor (I-Q-R ladder)	SD memory card or USB memory	●	●	●	●	●		
Sequence program monitor (I-Q-F ladder)	NEW SD memory card or USB memory	●	●	●	●	●		
Sequence program monitor (Ladder)	SD memory card or USB memory	●	●	●	●	●		
Sequence program monitor (SFC)	SD memory card or USB memory	●	●	●	●	●		
Network monitor		●	●	●	●	●		
CC-Link IE TSN / CC-Link IE Field		●	●	●	●	●		
Network diagnostics	NEW	●	●	●	●	●		
Intelligent module monitor		●	●	●	●	●		
Drive recorder	(SD memory card or USB memory)	●	●	●	●	●		
Servo amplifier graph	(SD memory card or USB memory)	●	●	●	●	●		
Motion program editor		● *4	● *4	● *4 NEW	—	—		
Motion program I/O	SD memory card or USB memory	● *4	● *4	● *4 NEW	—	—		
Servo amplifier monitor		●	●	●	●	●		
R motion monitor		●	●	●	●	●		
Q motion monitor		●	●	●	●	●		
R motion SFC monitor	NEW SD memory card or USB memory	●	●	●	●	●		
Q motion SFC monitor	SD memory card or USB memory	●	●	●	●	●		
CNC monitor 2		●	●	—	●	—		
CNC monitor		● *4	● *4	—	—	—		
CNC data I/O	SD memory card or USB memory	● *4	● *4	—	—	—		
CNC machining program edit		● *4	● *4	—	—	—		
Log viewer	(SD memory card or USB memory)	●	●	●	●	●		
FX list editor		●	●	—	—	—		
FX ladder monitor		●	●	●	●	●		
iQSS utility	SD memory card or USB memory	●	●	●	●	●		
System launcher		●	●	●	●	●		
System launcher (servo network)		●	●	●	●	●		
MELSEC-L troubleshooting		●	●	●	●	●		
GOT offline monitor	NEW (SD memory card or USB memory, battery)	●	●	●	●	●		

*1 Necessary units when using GT27, GT25, GT25 wide, GT25 handy, GT25 rugged, GT23, GT21 wide, GT21, or GS21 models are shown. Parenthesized devices are required depending on conditions of use.
 *2 Data is output to the printer that is recognized by the personal computer.
 *3 CSV files are saved in the virtual drive of the personal computer so that it is recommended to output the files to printers.
 *4 Only the GOTs with SVGA or higher resolution are supported.

*5 Remote personal computer operation function (Ethernet) cannot be used. The following screens are displayed horizontally: utility screen, monitor and data management screens that are displayed from the utility screen (sequence program monitor, etc.), video camera images in the multimedia and video display functions. For the details of other GOT operations when placed vertically, please refer to the relevant product manual or Help.
 *6 Excluding GT2103-PMBLS.
 *7 GT2104-RTBD only.
 *8 Excluding GT2705-VTBD.

Specifications

For the details of functions, supported controllers, and connection types, please refer to the relevant manual or Help of the GOT2000/GOT SIMPLE Series.
●: Supported —: Not supported

Category	Function name	Necessary devices *1	GT23	GT21 Wide	GT21	GS21-W-N NEW	GT SoftGOT2000	
Screen design	Barcode function		●	●	●*6	●	●	
	RFID function		●	●	●*6	●	●	
	GOT Mobile function	License, (SD memory card)	—	—	—	—	●*24 NEW	
	VNC server function	License	—	●	—	● NEW	—	
	Remote personal computer operation function (Ethernet)	License	—	—	—	—	—	
	Remote personal computer operation function (serial)	RGB input unit or Video/RGB input unit	—	—	—	—	—	
	Video display function	Video input unit or Video/RGB input unit	—	—	—	—	—	
	RGB display function	RGB input unit or Video/RGB input unit	—	—	—	—	—	
	Multimedia function	Multimedia unit, CF card	—	—	—	—	—	
	External I/O function	External I/O unit	—	—	—	—	—	
	Operation panel function	External I/O unit	—	—	—	—	●	
	Video output function	HDMI output	Digital video output unit	—	—	—	—	—
		RGB output	RGB output unit	—	—	—	—	—
	Report function	File output	(SD memory card or USB memory)	●	—	—	—	●*3
		Serial printer output	(SD memory card or USB memory)	●	●	●*6	●	●*3
		Ethernet printer output	(SD memory card or USB memory)	●	●	●*15	●	●*3
		PictBridge printer output	SD memory card or USB memory, printer unit	—	—	—	—	●*3
	Sound output function	Sound output unit *18	—	—	—	—	●	
	Server function, Client function		—	—	—	—	●*23 NEW	
	Mail send function		—	—	—	—	●	
	Network drive function		—	—	—	—	●	
	FTP server function	(SD memory card or USB memory)	●	●	●*15	●	—	
	File transfer function (FTP transfer)	SD memory card or USB memory	●	●	●*15	●	—	
	File transfer function (GOT internal transfer)	SD memory card or USB memory	—	—	—	—	—	
MES interface function	License, (SD memory card)	—	—	—	—	—		
Wireless LAN function	Wireless LAN communication unit	—	—	—	—	—		
USB mouse, USB keyboard		●	●	—	—	●		
GOT functions	Base screen		●	●	●	●	●	
	Overlap window		●	●	●	●	●	
	Superimpose window		●	●	●	●	●	
	Dialog window		●	●	●	●	●	
	Mobile screen		—	—	—	—	●*24 NEW	
	Key window		●	●	●	●	●	
	Language switching		●	●	●	●	●	
	System information		●	●	●	●	●	
	Operator authentication function	(SD memory card or USB memory)	●	●	●*16	●	●	
	Operation log	SD memory card or USB memory	●	● NEW	—	● NEW	●	
	Startup logo		●	●	●	●	●	
	KANA KANJI conversion		—	● NEW	—	—	—	
	FA transparent		●	—	●	●	—	
	SoftGOT-GOT link	License key	—	—	—	—	—	
	Backup/Restoration	SD memory card or USB memory	●	●	●*6	—	—	
	Multi-channel function		● (No units can be mounted)	● (No units can be mounted)	●*6 (No units can be mounted)	● (No units can be mounted)	●*21 4 channels	
	Station No. switching		●	●	●	●	●	
	GOT network interaction		●	—	—	—	●	
	Screen gesture function		—	—	—	—	—	
	Object gesture function		—	—	—	—	—	
	Security key authentication function		●	—	—	—	—	
	IP filter function		●	●	●	●	—	
	File manager	(SD memory card or USB memory)	●	—	—	—	—	
	Vertical display *5		—	(Rotate 90 ° to left)	(Rotate 90 ° to left)	(Rotate 90 ° to right)	(Rotate 90 ° to left)	
Vision sensor monitor NEW		—	—	—	—	—		
Device monitor	(SD memory card or USB memory)	●	●	●	●	—		
Sequence program monitor (Q-R ladder)	SD memory card or USB memory	—	—	—	—	—		
Sequence program monitor (Q-F ladder) NEW	SD memory card or USB memory	—	—	—	—	—		
Sequence program monitor (Ladder)	SD memory card or USB memory	—	—	—	—	—		
Sequence program monitor (SFC)	SD memory card or USB memory	—	—	—	—	—		
Network monitor		—	—	—	—	—		
CC-Link IE TSN / CC-Link IE Field		—	—	—	—	—		
Network diagnostics NEW		—	—	—	—	—		
Intelligent module monitor		—	—	—	—	—		
Drive recorder	(SD memory card or USB memory)	—	—	—	—	●*24 NEW		
Servo amplifier graph	(SD memory card or USB memory)	—	—	—	—	●*24 NEW		
Motion program editor		—	—	—	—	—		
Motion program I/O	SD memory card or USB memory	—	—	—	—	—		
Servo amplifier monitor		—	—	—	—	—		
R motion monitor		—	—	—	—	—		
Q motion monitor		—	—	—	—	—		
R motion SFC monitor NEW	SD memory card or USB memory	—	—	—	—	—		
Q motion SFC monitor	SD memory card or USB memory	—	—	—	—	—		
CNC monitor 2		—	—	—	—	—		
CNC monitor		—	—	—	—	—		
CNC data I/O	SD memory card or USB memory	—	—	—	—	—		
CNC machining program edit		—	—	—	—	—		
Log viewer	(SD memory card or USB memory)	—	—	—	—	—		
FX list editor		●	●	●*7	●	—		
FX ladder monitor		—	—	—	—	—		
iQSS utility	SD memory card or USB memory	—	—	—	—	—		
System launcher		●	—	—	—	●*24 NEW		
System launcher (servo network)		—	—	—	—	●*24 NEW		
MELSEC-L troubleshooting		—	—	—	—	—		
GOT offline monitor NEW	(SD memory card or USB memory, battery)	●	—	—	—	●		

*9 To use multiple units such as extension units, barcode readers, or RFID controllers with a GT2705-VTBD, the total current consumption of the units should be less than the value that the GT2705-VTBD can provide. For the details, please refer to the relevant manual of the GOT2000 Series.
*10 GT2715-XTBA, GT2715-XTBD, GT2712-STBA, GT2712-STBD, GT2712-STWA, GT2712-STWD only.
*11 For the applicable communication units and option units, please refer to "Product list" (page 196) and the relevant product manual.
*12 Use the standard interface of the personal computer.
*13 When using functions that require a USB memory or SD memory card, a virtual drive in the personal computer is used.
*14 GT2103-PMBD, GT2103-PMBDS, and GT2103-PMBDS2 require an SD memory card unit (GT21-03SDCD) separately. GT2103-PMBLS does not allow for SD memory cards.

*15 GT2104-RTBD, GT2103-PMBD only.
*16 On GT2103-PMBLS, only the functions that do not require SD memory card can be used.
*17 Excluding GT2505-VTBD.
*18 GT25 wide and GT25 rugged models have a built-in sound output interface so that the sound output unit is not required.
*19 GT2505HS-VTBD supports the function with Ethernet connection only.
*20 GT21 has different interfaces depending on the model. For the details, please refer to the performance specifications on pages 152 and 153.
*21 Only Ethernet, OPC UA client, and microcomputer connections are supported.
*22 If the function version is B or earlier, the memory for operation (RAM) is 128 MB.
*23 GT SoftGOT2000 supports the server function only.
*24 It is recommended to use GT SoftGOT2000 (Multiple channels) for this function.

Specifications

For the details of the connection configuration, please refer to the GOT2000 Series Connection Manual.

Series		Model name	Connection type																									
			GT27/GT25							GT23				GT21/GS21-W-N ¹														
			Ethernet connection	Direct CPU connection (serial)	Serial communication connection	CC-Link IE TSN connection ^{4,2}	CC-Link IE Controller Network connection ^{4,2}	CC-Link IE Field Network connection ^{4,2}	CC-Link connection (Intelligent device station) ^{4,2}	CC-Link connection (Via G4) ²	Bus connection ^{3,4,2}	MELSECNET/H connection ^{4,2}	MELSECNET/10 connection ^{4,2,2}	Multi-drop connection ⁵	Ethernet connection	Direct CPU connection (serial)	Serial communication connection	CC-Link connection (Via G4) ²	Multi-drop connection ⁵	Ethernet connection ⁶	Direct CPU connection (serial)	Serial communication connection	CC-Link connection (Via G4) ²	Multi-drop connection ^{5,7}				
Programmable controller	MELSEC-F Series	FX0																										
		FX0S																										
		FX0N																										
		FX1	X		X	X	X	X	X	X	X	X	X	X														
		FX1S																										
		FX1N																										
		FX1NC																										
		FX2	X		X	X	X	X	X	X	X	X	X	X	X													
		FX2C																										
		FX2N	X		X	X	X	X	X	X	X	X	X	X	X													
		FX2NC																										
		FX3G																										
		FX3GC																										
		FX3U																										
FX3UC																												
FX3S																												
FX3GE																												
C Controller module	MELSEC IQ-R Series	R12CCPU-V																										
	MELSEC-Q Series	Q24DHCCPU-V																										
		Q24DHCCPU-VG																										
		Q24DHCCPU-LS																										
		Q12DCCPU-V ²⁹																										
Q26DHCCPU-LS																												
MELSEC <i>in</i> CPU NEW	MELSEC IQ-R Series	R102WCPU-W																										
Safety controller	MELSEC-WS Series	WS0-CPU0																										
		WS0-CPU1																										
		WS0-CPU3																										
Motion controller	MELSEC IQ-R Series	R16MTCPU																										
		R32MTCPU																										
		R64MTCPU																										
		Q172CPU ³²	Discontinued																									
	Q173CPU ³²	Discontinued																										
	Q172CPUN ³²	Discontinued																										
	Q173CPUN ³²	Discontinued																										
	Q172HCPU	Discontinued																										
	Q173HCPU	Discontinued																										
	Q172DCPU																											
	Q173DCPU																											
	Q172DCPU-S1																											
	Q173DCPU-S1																											
	Q172DSCPU																											
	Q173DSCPU																											
	Q170MCPUN ³⁵																											
	Q170MSCPU																											
Q170MSCPU-S1																												
MELSECNET/H remote I/O station		MR-MQ100																										
		QJ72LP25-25																										
		QJ72LP25G																										
CC-Link IE Field Network head module	MELSEC IQ-R Series	RJ22GF15-T2																										
		LJ72GF15-T2																										
CC-Link IE Field Network Ethernet adapter module		NZ2GF-ETB																										
CC-Link IE TSN Motion module NEW		RD78G4																										
		RD78G8																										
		RD78G16																										
		RD78G32																										
		RD78G64																										
		RD78GHV																										
		RD78GHW																										

Specifications

Connectable model list (GOT2000/GOT SIMPLE)

- *1 GT2103-PMBLS supports connection with MELSEC iQ-F Series and MELSEC-F Series only.
- *2 CC-Link (via G4): connect to the CC-Link system via AJ65BT-G4-S3 or AJ65BT-R2N.
- *3 When using bus connection, follow the precautions below.
 - When multiple GOTs are connected, the GOT2000 Series cannot be connected with the GOT800 Series or A77GOT.
 - Bus connection cannot be established with QCPU (A model).
 - The number of connectable GOTs is restricted according to the CPU type and the number of intelligent function modules.
 - The GOT2000 Series, GOT1000 Series, and GOT-A900 Series can be connected together in a system. Please refer to the following Technical Bulletins on the Mitsubishi Electric Factory Automation Global website (www.MitsubishiElectric.com/fa/).
 - "Precautions when Replacing GOT1000 Series with GOT2000 Series" No. GOT-A-0061
 - "Precautions when Replacing GOT-A900 Series with GOT2000 Series" No. GOT-A-0062
- *4 Includes the case on the MELSECNET/H network system in the MNET/10 mode. The GOT cannot be connected to the remote I/O network.
- *5 When the number of connected slave GOTs and the device points of each GOT increase, the device update cycle on the screen may get slower.
(Please consider 250 points as a guide of 1 GOT, and 750 points as a guide of the total points.)
- *6 Only supported by GT2107-WTBD, GT2107-WTSD, GT2104-RTBD, GT2103-PMBD, GS2110-WTBD-N, and GS2107-WTBD-N.
- *7 GT2103-PMBDS2 and GT2103-PMBLS are not supported.
- *8 Access via the serial port (RS-232) of QCPU in the multiple CPU system since the CPU has no serial port.
- *9 Use a CC-Link IE Controller Network module with the upper five digits of the serial No. later than 09042.
- *10 Use a CPU with the upper five digits of the serial No. later than 12012.
- *11 When using the bus extension connector box (A9GT-QCNCB), attach it to the extension base unit.
(Connecting it to the main base unit is not allowed.)
- *12 Use a CPU and a CC-Link IE Controller Network module with the upper five digits of the serial No. later than 09042.
- *13 Use a CPU of function version B or later or a CC-Link IE Controller Network module of function version D or later.
- *14 In the multiple CPU system, use a CPU or a MELSECNET/H network module of function version B or later.
- *15 GT2103-PMBD and GT2103-PMBLS cannot be connected to Q00J, Q00, or Q01CPU.
- *16 When in multiple CPU system configuration, use a CPU of function version B or later.
- *17 Use a CPU with the upper five digits of the serial No. later than 09012.
When the total number of stations in a network is 65 or more, use a CC-Link IE Controller Network module with the upper five digits of the serial No. 09042 or later.
- *18 In the Ethernet, MELSECNET/H, or MELSECNET/10 connection, to monitor a QCPU in the multiple CPU system, always use a network module of function version B or later.
- *19 Use a CC-Link IE Controller Network module of function version D or later.
- *20 The supported version of the main units varies depending on the Ethernet module to be used as shown below.

Ethernet module *	CPU		
	FX3U(C)	FX3G(C)	FX3S
FX3U-ENET-L	Ver. 2.21 or later	FX3U-ENET-L is not supported.	
FX3U-ENET-ADP *	Ver. 3.10 or later	Ver. 2.00 or later	Ver. 1.00 or later

* To connect to a FX3SCPU, use a FX3U-ENET-ADP Ver.1.20 or later.

- *21 Use a CPU with the upper five digits of the serial No. later than 10042 or a CC-Link IE Controller Network module of function version D or later.
- *22 Use a CPU with the upper five digits of the serial No. later than 10032 or a CC-Link IE Controller Network module of function version D or later.
- *23 Use a CPU with the upper five digits of the serial No. later than 13042.
- *24 When using a LJ71E71-100, use a CPU with the upper five digits of the serial No. later than 14112.
- *25 Use a LJ71E71-100 since the CPU has no built-in Ethernet port.

- *26 Use a CPU with the upper five digits of the serial No. later than 13012.
- *27 The adapter L6ADP-R2 or L6ADP-R4 is required. When using the L6ADP-R4 adapter, use a CPU with the upper five digits of the serial No. later than 15102.
- *28 Use the serial port of a serial communication module controlled by another CPU on the multiple CPU system.
- *29 Use a CPU with the upper five digits of the serial No. later than 12042.
- *30 GT2103-PMBD and GT2103-PMBLS cannot be connected to the MELSEC-WS Series.
- *31 In Ethernet connection, serial communication connection, CC-Link (intelligent device station) connection, CC-Link (via G4) connection, MELSECNET/H connection, or MELSECNET/10 connection, use main modules with the following product numbers.
Q172CPU; Product number N***** or later
Q173CPU; Product number M***** or later
- *32 When using SV13, SV22, or SV43, use the Motion CPU on which any of the following main OS software version is installed.
 - Ethernet connection, serial communication connection, CC-Link (intelligent device station) connection, CC-Link (via G4) connection, MELSECNET/H connection, MELSECNET/10 connection
SW6RN-SV13QC□: 00H or later
SW6RN-SV22QC□: 00H or later
SW5RN-SV43QC□: 00B or later
 - Direct CPU connection (serial), bus connection, multi-drop connection
SW6RN-SV13QC□: 00E or later
SW6RN-SV22QC□: 00E or later
SW5RN-SV43QC□: 00B or later
- *33 In direct CPU connection (serial), bus connection, or multi-drop connection, use main modules with the following product numbers.
Q172CPU; Product number K***** or later
Q173CPU; Product number J***** or later
- *34 PERIPHERAL I/F can be used.
- *35 When using SV43, use the CPU on which any of the following main OS software version is installed.
SW7DNC-SV43QC□: 00F or later
- *36 Only the PLC CPU area (CPU No.1) can be monitored.
- *37 Use the built-in Ethernet port since RJ71EN71 is not supported.
- *38 Only cyclic transmission can be used.
- *39 Mount a safety function module R6SFM next to the RnSFCPU on the base unit. The RnSFCPU and the safety function module R6SFM must have the same pair version. If their pair versions differ, the RnSFCPU does not operate.
- *40 Up to 32 axes are supported by GT21. R standard placement method is not supported.
- *41 Mount a redundant function module R6RFM next to the RnPCPU on the base unit when building a redundant system.
- *42 GT2512-WXTBD, GT2512-WXTSD, GT2510-WXTBD, GT2510-WXTSD, GT2507-WTBD, GT2507-WTSD, GT2507-FWTSD, GT2505-VTBD, GT2506HS-VTBD, and GT2505HS-VTBD are not supported.
- *43 Mount the SIL2 function module R6PSFM and redundant function module R6RFM next to the RnSFCPU on the base unit.
- *44 Use the built-in Ethernet port since LJ71EN71 is not supported.
- *45 Connect the GOT and Motion module through the built-in Ethernet port of the programmable controller to monitor the global labels of the Motion module with the GOT.
- *46 Use the following firmware version.
Line connection or star connection: 11 or later, Ring connection: 18 or later
- *47 Use the following firmware version.
Line connection or star connection: 43 or later, Ring connection: 50 or later
- *48 Use firmware version 20 or later.
- *49 Use firmware version 1.210 or later.
- *50 For C Controller module (MELSEC iQ-R series), use firmware version 15 or later.

For the details of the connection configuration, please refer to the GOT2000 Series Connection Manual.

■ Modules usable when connected with Mitsubishi Electric programmable controllers/C Controller modules/Motion controllers

● Ethernet connection

CPU series	Ethernet module	
MELSEC iQ-R Series	RJ71EN71 ^{*4} RJ71GN11-T2 ^{*5} RD78G4 ^{*5} ^{*6} NEW RD78G8 ^{*5} ^{*6} NEW RD78G16 ^{*5} ^{*6} NEW	RD78G32 ^{*5} ^{*6} NEW RD78G64 ^{*5} ^{*6} NEW RD78GHV ^{*5} ^{*6} NEW RD78GHW ^{*5} ^{*6} NEW
C Controller module (MELSEC iQ-R Series) ^{*7}	RJ71GN11-T2 RD78G4 RD78G8 RD78G16	RD78G32 RD78G64 RD78GHV RD78GHW
MELSECWinCPU (MELSEC iQ-R Series) NEW	RJ71GN11-T2	
MELSEC iQ-F Series NEW	FX5-ENET ^{*8} ^{*9} FX5-ENET/IP ^{*8} ^{*9}	FX5-CCLGN-MS ^{*8} FX5-40SSC-G ^{*8} ^{*10} FX5-80SSC-G ^{*8} ^{*10}
Motion controller (MELSEC iQ-R Series) CC-Link IE Field Network head module (MELSEC iQ-R Series)	RJ71EN71 ^{*4}	
MELSEC-Q Series (Q mode) MELSEC-QS Series C Controller module (MELSEC-Q Series) Motion controller (MELSEC-Q Series)	QJ71E71-100 QJ71E71-B5 QJ71E71-B2 QJ71E71	
MELSEC-L Series	LJ71E71-100 ^{*1}	
MELSEC-F Series	FX3U-ENET-L ^{*2}	FX3U-ENET-ADP ^{*2} ^{*3}
CC-Link IE Field Network Ethernet adapter module NEW	NC2ZGF-ETB	

*1 Use a CPU with the upper five digits of the serial No. later than 14112.

*2 Options for extension controller may be required depending on the connected CPU.

*3 To connect to a FX3SCPU, use a FX3U-ENET-ADP Ver.1.20 or later.

*4 Use firmware version 12 or higher when building a redundant system.

*5 For connectable programmable controller CPUs and their firmware versions that support connection to each module, please refer to the manual of the CPU or the module to use.

*6 Use a Motion module with software version 06 or later.

*7 When connecting to the CC-Link IE TSN master/local module or Motion module, use the C Controller module (MELSEC iQ-R series) with firmware version 15 or later.

*8 FX5UJ is not supported.

*9 For FX5-ENET and FX5-ENET/IP, use firmware Ver.1.100 or later.

*10 For FX5U and FX5UC that support FX5-ENET or FX5-ENET/IP, use firmware Ver.1.240 or later.

*11 For FX5U and FX5UC that support FX5-40SSC-G or FX5-80SSC-G, use firmware Ver.1.230 or later.

● Serial communication connection

CPU series	Serial communication module ^{*1}		
	Model name	CH1	CH2
MELSEC iQ-R Series C Controller module (MELSEC iQ-R Series) ^{*5} MELSECWinCPU (MELSEC iQ-R Series) ^{*5} NEW Motion controller (MELSEC iQ-R Series) CC-Link IE Field Network head module (MELSEC iQ-R Series)	RJ71C24 ^{*4}	RS-232	RS-422/485
	RJ71C24-R2 ^{*4}	RS-232	RS-232
	RJ71C24-R4 ^{*4}	RS-422/485	RS-422/485
	QJ71C24 ^{*2}	RS-232	RS-422/485
	QJ71C24-R2 ^{*2}	RS-232	RS-232
	QJ71C24N	RS-232	RS-422/485
	QJ71C24N-R2	RS-232	RS-232
	QJ71C24N-R4	RS-422/485	RS-422/485
	QJ71CMO ^{*3}	Modular connector	RS-232
	QJ71CMON ^{*3}	Modular connector	RS-232
MELSEC-L Series CC-Link IE Field Network head module (MELSEC-L Series)	LJ71C24 LJ71C24-R2	RS-232 RS-232	RS-422/485 RS-232

*1 Communication cannot be performed with RS-485.

*2 Either CH1 or CH2 can be used for the function version A.
Both CH1 and CH2 can be used together for the function version B or later.

*3 Only CH2 can be connected.

*4 Use firmware version 07 or higher when building a redundant system.

*5 Use the serial port of a serial communication module controlled by another CPU on the multiple CPU.

● CC-Link IE TSN connection

CPU series	CC-Link IE TSN module
MELSEC iQ-R Series	RJ71GN11-T2 ^{*1} ^{*2} ^{*3} ^{*4}
MELSEC iQ-F Series NEW	FX5-CCLGN-MS ^{*5}

*1 Usable with MELSEC iQ-R Series programmable controller CPUs only.

*2 To use R00CPU, R01CPU, or R02CPU, use the firmware version 11 or later.

*3 To use programmable controller CPU (excluding R00CPU, R01CPU, R02CPU), use the firmware version 43 or later.

*4 For the ring connection, use firmware version 10 or later.

*5 The ring connection is not supported.

● CC-Link IE Controller Network connection

CPU series	CC-Link IE Controller Network module
MELSEC iQ-R Series C Controller module (MELSEC iQ-R Series) MELSECWinCPU (MELSEC iQ-R Series) NEW Motion controller (MELSEC iQ-R Series)	RJ71GP21-SX ^{*2}
MELSEC-Q Series (Q mode) MELSEC-QS Series C Controller module (MELSEC-Q Series) Motion controller (MELSEC-Q Series)	QJ71GP21-SX ^{*1} QJ71GP21-SX ^{*1}

*1 When the CC-Link IE Controller Network is in the extended mode, use a module with the upper five digits of the serial No. 12052 or later.

*2 Use firmware version 12 or higher when building a redundant system.

● CC-Link IE Field Network connection

CPU series	CC-Link IE Field Network module
MELSEC iQ-R Series C Controller module (MELSEC iQ-R Series) Motion controller (MELSEC iQ-R Series)	RJ71GF11-T2 ^{*1} RJ71EN71 ^{*1} RD77GF4
MELSEC-Q Series (Q mode) C Controller module (MELSEC-Q Series) Motion controller (MELSEC-Q Series)	QJ71GF11-T2 QD77GF4
MELSEC-QS Series	QS0J71GF11-T2
MELSEC-L Series	LJ71GF11-T2
MELSEC iQ-F Series	FX5-CCLIEF

*1 Use firmware version 12 or higher when building a redundant system.

Specifications

Connectable model list (GOT2000/GOT SIMPLE)

■ Modules usable when connected with Mitsubishi Electric programmable controllers/C Controller modules/Motion controllers

● CC-Link (intelligent device station) connection

CPU series	CC-Link module	
MELSEC iQ-R Series C Controller module (MELSEC iQ-R Series) MELSECWinCPU (MELSEC iQ-R Series) NEW Motion controller (MELSEC iQ-R Series) CC-Link IE Field Network head module (MELSEC iQ-R Series)	RJ61BT11 *2	
MELSEC-Q Series (Q mode) C Controller module (MELSEC-Q Series) Motion controller (MELSEC-Q Series)	QJ61BT11 QJ61BT11N	
MELSEC-L Series	LJ61BT11	
MELSEC iQ-F Series	FX3U-16CCL-M *1	FX5-CCL-MS
MELSEC-F Series	FX3U-16CCL-M	

*1 When using an FX3U-16CCL-M with the MELSEC iQ-F Series, bus conversion module (FX5-CNV-BUS or FX5-CNV-BUSC) is required.

*2 Use firmware version 04 or higher when building a redundant system.

● CC-Link (via G4) connection

CPU series	CC-Link module	Peripheral module
MELSEC-Q Series (Q mode) C Controller module (MELSEC-Q Series) Motion controller (MELSEC-Q Series)	QJ61BT11 QJ61BT11N	AJ65BT-G4-S3 AJ65BT-R2N
MELSEC-L Series	LJ61BT11	

● MELSECNET/H connection

CPU series	MELSECNET/H network module	
	Optical loop	Coaxial bus
MELSEC-Q Series (Q mode) *1 MELSEC-QS Series Motion controller (MELSEC-Q Series)	QJ71LP21 QJ71LP21-25 QJ71LP21S-25	QJ71BR11 *1
C Controller module (MELSEC-Q Series)	QJ71LP21-25 QJ71LP21S-25	

*1 Use function version B or later of the MELSECNET/H network module and CPU.

● MELSECNET/10 connection

CPU series	MELSECNET/H (MNET/10 mode), MELSECNET/10 network module	
	Optical loop	Coaxial bus
MELSEC-Q Series (Q mode) *1 MELSEC-QS Series Motion controller (MELSEC-Q Series)	QJ71LP21 QJ71LP21-25 QJ71LP21S-25	QJ71BR11 *1
C Controller module (MELSEC-Q Series)	QJ71LP21-25 QJ71LP21S-25	

*1 Use function version B or later of the MELSECNET/H network module and CPU.

◆ Mitsubishi Electric industrial computers

Series	Model name	GT27/GT25/GT23/GT21/GS21-W-N *1												
		Connection type												
		Ethernet connection	Direct CPU connection (serial)	Serial communication connection	CC-Link IE TSN connection	CC-Link IE Controller Network connection	CC-Link IE Field Network connection	CC-Link connection (intelligent device station)	CC-Link connection (via G4)	Bus connection	MELSECNET/H connection	MELSECNET/10 connection	Multi-drop connection	
MELIPC	MI5122-VW	○	×	×	×	×	○	×	×	×	×	×	×	

*1 GT23, GT21 and GS21-W-N support connection using Ethernet connection.

For the details of the connection configuration, please refer to the GOT2000 Series Connection Manual.

◆ Mitsubishi Electric inverters

Series		GT27/GT25/GT23/GT21/GS21-W-N ^{*1}				GT27/GT25	
		RS-485	RS-232	Multi-drop connection	Ethernet	CC-Link IE TSN	
FR-D700 Series	FR-D7□0	○	×	×	×	×	
	FR-D7□0S	○	×	×	×	×	
	FR-D7□0W	○	×	×	×	×	
FR-F700PJ Series	FR-F7□0PJ (F)	○	×	×	×	×	
	FR-F7□0	○	×	×	×	×	
FR-E700 Series	FR-E7□0	○	×	×	×	×	
	FR-E7□0S	○	×	×	×	×	
	FR-E7□0W	○	×	×	×	×	
	FR-E7□0-NE ^{*2 *3 *6}	×	×	×	○ ^{*4}	×	
FR-F700 Series	FR-F7□0	○	×	×	×	×	
FR-F700P Series	FR-F7□0P	○	×	×	×	×	
	FR-A8□0 ^{*7 *8}	○	×	×	○ ^{*5}	○ ^{*5}	
FR-A800 Series	FR-A8□2 ^{*7 *8}	○	×	×	○ ^{*5}	○ ^{*5}	
	FR-A8□6 ^{*7 *8}	○	×	×	○ ^{*5}	○ ^{*5}	
	FR-A8□0-GF ^{*7}	○	×	×	○	×	
	FR-A8□2-GF ^{*7}	○	×	×	○	×	
	FR-A8□0-GN ^{*8}	NEW	○	×	×	○	
	FR-A8□2-GN ^{*8}	NEW	○	×	×	○	
	FR-A8□0-CRN ^{*7}	○	×	×	×	×	
FR-A800 Plus Series	FR-A8□2-CRN ^{*7}	○	×	×	×	×	
	FR-A8□0-E-CRN ^{*6}	○	×	×	○	×	
	FR-A8□2-E-CRN ^{*6}	○	×	×	○	×	
	FR-A8□0-R2R ^{*7}	○	×	×	×	×	
	FR-A8□2-R2R ^{*7}	○	×	×	×	×	
	FR-A8□0-E-R2R ^{*6}	○	×	×	○	×	
	FR-A8□2-E-R2R ^{*6}	○	×	×	○	×	
	FR-A8□0-AWH ^{*6}	NEW	○	×	×	○ ^{*5}	×
	FR-A8□0-E-AWH ^{*6}	NEW	○	×	×	○	×
	FR-A8□0-LC ^{*7}	NEW	○	×	×	○ ^{*5}	×
	FR-A8□0-E-LC ^{*6}	NEW	○	×	×	○	×
FR-F800 Series	FR-F8□0 ^{*7 *8}	○	×	×	○ ^{*5}	○ ^{*5}	
	FR-F8□2 ^{*7 *8}	○	×	×	○ ^{*5}	○ ^{*5}	
	FR-F8□6 ^{*7 *8}	○	×	×	○ ^{*5}	○ ^{*5}	
	FR-F8□0-E ^{*6}	○	×	×	○	×	
	FR-F8□2-E ^{*6}	○	×	×	○	×	
	FR-F8□6-E ^{*6}	○	×	×	○	×	
FR-E800 Series	NEW FR-E8□0	○	×	×	×	×	
	FR-E8□0-E ^{*6 *8}	×	×	×	○	○	
FR-B Series	FR-B-□□□□	○	×	×	×	×	
FR-B3 Series	FR-B3- (N) (H) □□□□	○	×	×	×	×	
MELIPM Series	MD-CX522-□□K	○	×	×	×	×	
	MD-CX522-□□K-A0	○	×	×	×	×	

*1 Except GT2103-PMBDS2 and GT2103-PMBLS.

*2 Use FR-E700-NE with SERIAL (serial No.) **8***** or later.

*3 Use FR-E700-SC-NNE or FR-E700-SC-ENE with SERIAL (serial No.) **8***** or later.

*4 Supports UDP only.

*5 A built-in option (FR-A8NOG) is required.

*6 Ethernet connection to inverters is supported via a programmable controller CPU.

*7 CC-Link IE Field Network connection to inverters is supported via a programmable controller CPU.

*8 CC-Link IE TSN connection to inverters is supported via a programmable controller CPU.

◆ Mitsubishi Electric servo amplifiers (general-purpose)

Series	Model name	GT27/GT25/GT23/GT21/GS21-W-N ^{*1}			
		RS-422	RS-232	Multi-drop connection	Ethernet
MELSERVO-J5 Series	MR-J5-□G	×	×	×	○
	MR-J5-□G-RJ	×	×	×	○
	NEW MR-J5W2-□G	×	×	×	○
	MR-J5W3-□G	×	×	×	○
	MR-J5D1-□G4	×	×	×	○
	MR-J5D2-□G4	×	×	×	○
	MR-J5D3-□G4	×	×	×	○
MELSERVO-J4 Series	MR-J4-□A	○	○ ^{*2}	×	×
	MR-J4-□A-RJ	○	○ ^{*2}	×	×
MELSERVO-J3 Series	MR-J3-□A	○	○ ^{*2}	×	×
	MR-J3-□T	○	○ ^{*2}	×	×
MELSERVO-J2-Super Series	MR-J2S-□A	○	○	×	×
	Discontinued MR-J2S-□CP	○	○	×	×
MELSERVO-J2M Series	MR-J2M-□CL	○	○	×	×
	Discontinued MR-J2M-P8A	○	○	×	×
MELSERVO-J2M Series	MR-J2M-□DU	○	○	×	×
	Discontinued MR-J2M-P8A	○	○	×	×
MELSERVO-JET Series	NEW MR-JET-□G	×	×	×	○
MELSERVO-JE Series	MR-JE-□A	○	×	×	×
	MR-JE-□C	×	×	×	○

*1 Except GT2103-PMBLS.

*2 RS-422/232 interface converter or RS-422/232 conversion cable is required.

Specifications

Connectable model list (GOT2000/GOT SIMPLE)

◆ Mitsubishi Electric servo amplifiers (SSCNET III/H)

Servo amplifiers (SSCNET III/H) are connected to the GOT through a motion controller or Simple Motion module.

Series	Model name	Motion controller or programmable controller		GT27/GT25/GT23/GT21/GS21-W-N *6																	
				Connection type																	
				Simple Motion module	CPU type	Ethernet connection	Direct CPU connection (serial)	Serial communication connection	CC-Link IE TSN connection	CC-Link IE Controller Network connection	CC-Link IE Field Network connection	CC-Link connection (intelligent device station) *1	CC-Link connection (via G4)	Bus connection	MELSECNET/H connection	MELSECNET/10 connection *2	Multi-drop connection				
MELSERVO-J4 Series	MR-J4-□B MR-J4-□B-RJ MR-J4W2-□B MR-J4W3-□B	-	RnMCPU	○	×	○	×	○	×	○	×	○	×	○	×	○	×	○	×		
			Q17nDSCPU	○	○	○	○	○	○	○	○	○	○	○	○	○	○	○	○	○	
			Q170MPCPU	○	○	○	○	○	○	○	○	○	○	○	○	○	○	○	○	○	
		RD77MS	RnCPU	○	×	○	×	○	×	○	×	○	×	○	×	○	×	○	×	○	×
		QD77MS *3	QnCPU	○	○	○	○	○	○	○	○	○	○	○	○	○	○	○	○	○	○
		LD77MS	LnCPU	○	○	○	○	○	○	○	○	○	○	○	○	○	○	○	○	○	○
		FX5-40SSC-S	FX5CPU	○	○	○	○	○	○	○	○	○	○	○	○	○	○	○	○	○	○
FX5-80SSC-S	FX5CPU	○	○	○	○	○	○	○	○	○	○	○	○	○	○	○	○	○	○		
MELSERVO-JE Series	MR-JE-□B	RD77MS *4	RnCPU	○	×	○	×	○	×	○	×	○	×	○	×	○	×	○	×		
			QD77MS *5	QnCPU	○	○	○	○	○	○	○	○	○	○	○	○	○	○	○	○	
			LD77MS *5	LnCPU	○	○	○	○	○	○	○	○	○	○	○	○	○	○	○	○	
		FX5-40SSC-S	FX5CPU	○	○	○	○	○	○	○	○	○	○	○	○	○	○	○	○	○	
		FX5-80SSC-S	FX5CPU	○	○	○	○	○	○	○	○	○	○	○	○	○	○	○	○	○	

*1 Connect the GOT as a CC-Link intelligent device station.

*2 Only supports the case where MELSECNET/H is used in the MELSECNET/10 mode. Connection to the remote I/O network is not allowed.

*3 Use a module with the upper five digits of the serial No. later than 15041.

*4 Use a module with the firmware version 3 or later.

*5 Use a module with the upper five digits of the serial No. later than 16102.

*6 GT23, GT21 and GS21-W-N support connection using Ethernet connection, direct CPU connection (serial), serial communication connection, or CC-Link connection (via G4).

◆ Mitsubishi Electric servo amplifiers (CC-Link IE Field Network)

Servo amplifiers (CC-Link IE Field Network) are connected to the GOT through a Simple Motion module or a master/local module.

Series	Model name	Motion controller or programmable controller		GT27/GT25/GT23/GT21/GS21-W-N *6 *7															
				Connection type															
				Simple Motion module, or master/local module	CPU type	Ethernet connection	Direct CPU connection (serial)	Serial communication connection	CC-Link IE TSN connection	CC-Link IE Controller Network connection	CC-Link IE Field Network connection *8	CC-Link connection (intelligent device station) *1	CC-Link connection (via G4)	Bus connection	MELSECNET/H connection	MELSECNET/10 connection *2	Multi-drop connection		
MELSERVO-J4 Series	MR-J4-□GF MR-J4-□GF-RJ	RD77GF4*3	RnCPU	○	×	○	○	○	○	○	×	×	×	×	×	×	×	×	
		RD77GF8*3	RnCPU	○	×	○	○	○	○	○	×	×	×	×	×	×	×	×	×
		RD77GF16*3	RnCPU	○	×	○	○	○	○	○	×	×	×	×	×	×	×	×	×
		RD77GF32	RnCPU	○	×	○	○	○	○	○	×	×	×	×	×	×	×	×	×
		QD77GF4*4	QnCPU	○	○	○	○	○	○	○	×	×	○	○	○	○	○	○	○
		QD77GF8*4	QnCPU	○	○	○	○	○	○	○	×	×	○	○	○	○	○	○	○
		QD77GF16*4	QnCPU	○	○	○	○	○	○	○	×	×	○	○	○	○	○	○	○
		RnENCPU	RnCPU	○	×	○	○	○	○	○	×	×	×	×	×	×	×	×	×
		RJ71EN71	RnCPU	○	×	○	○	○	○	○	×	×	×	×	×	×	×	×	×
		RJ71GF11-T2	RnCPU	○	×	○	○	○	○	○	×	×	×	×	×	×	×	×	×
		QJ71GF11-T2*5	QnCPU	○	○	○	○	○	○	○	×	×	○	○	○	○	○	○	○
		LJ71GF11-T2*5	LnCPU	○	×	○	○	○	○	○	×	×	○	○	○	○	○	○	○

*1 Connect the GOT as a CC-Link intelligent device station.

*2 Only supports the case where MELSECNET/H is used in the MELSECNET/10 mode. Connection to the remote I/O network is not allowed.

*3 To use the motion mode, use a module with the firmware version 1 or later; to use the I/O mode, use a module with the firmware version 2 or later.

*4 To use the I/O mode, use a module with the upper five digits of the serial No. later than 18022.

*5 Use a module with the upper five digits of the serial No. later than 14102. Motion mode is not supported.

*6 GT23 supports connection using Ethernet connection, direct CPU connection (serial), serial communication connection, or CC-Link connection (via G4).

*7 GT21 and GS21-W-N support connection using Ethernet connection.

*8 Not connectable from the GOT in the same network.

◆ Mitsubishi Electric servo amplifiers (CC-Link IE TSN) NEW

Servo amplifiers (CC-Link IE TSN) are connected to the GOT through a Motion module.

Series	Model name	Programmable controller		GT27/GT25/GT23/GT21/GS21-W-N														
				Connection type														
				Motion module *2	CPU type	Ethernet connection *1	Direct CPU connection (serial)	Serial communication connection	CC-Link IE TSN connection	CC-Link IE Controller Network connection	CC-Link IE Field Network connection	CC-Link connection (intelligent device station)	CC-Link connection (via G4)	Bus connection	MELSECNET/H connection	MELSECNET/10 connection	Multi-drop connection	
MELSERVO-J5 Series	MR-J5-□G MR-J5-□G-RJ MR-J5W2-□G MR-J5W3-□G MR-J5D1-□G4 MR-J5D2-□G4 MR-J5D3-□G4	RD78G4	RnCPU R12CCPU-V	○	×	×	×	×	×	×	×	×	×	×	×	×	×	
		RD78G8		○	×	×	×	×	×	×	×	×	×	×	×	×	×	
		RD78G16		○	×	×	×	×	×	×	×	×	×	×	×	×	×	×
		RD78G32		○	×	×	×	×	×	×	×	×	×	×	×	×	×	×
		RD78G64		○	×	×	×	×	×	×	×	×	×	×	×	×	×	×
		RD78GHV		○	×	×	×	×	×	×	×	×	×	×	×	×	×	×
		RD78GHW		○	×	×	×	×	×	×	×	×	×	×	×	×	×	×
		FX5-40SSC-G		FX5U	○	×	×	×	×	×	×	×	×	×	×	×	×	×
		FX5-80SSC-G		FX5UC	○	×	×	×	×	×	×	×	×	×	×	×	×	×
		RD78G4		RnCPU R12CCPU-V	○	×	×	×	×	×	×	×	×	×	×	×	×	×
RD78G8	○	×	×		×	×	×	×	×	×	×	×	×	×	×			
RD78G16	○	×	×		×	×	×	×	×	×	×	×	×	×	×			
RD78G32	○	×	×		×	×	×	×	×	×	×	×	×	×	×			
RD78G64	○	×	×		×	×	×	×	×	×	×	×	×	×	×			
RD78GHV	○	×	×		×	×	×	×	×	×	×	×	×	×	×			
RD78GHW	○	×	×		×	×	×	×	×	×	×	×	×	×	×			
FX5-40SSC-G	FX5U	○	×		×	×	×	×	×	×	×	×	×	×	×			
FX5-80SSC-G	FX5UC	○	×		×	×	×	×	×	×	×	×	×	×	×			

*1 Connect a servo amplifier to the built-in Ethernet port of a programmable controller CPU directly or via a hub.

*2 When monitoring a servo amplifier through a Motion module, the available mode on the servo amplifier varies depending on the firmware version of the Motion module to use. For the details, please refer to the manual of the Motion module to use.

For the details of the connection configuration, please refer to the GOT2000 Series Connection Manual.

◆ Mitsubishi Electric robot controllers

Series	Controller name	GT27/GT25/GT23/GT21/GS21-W-N *5											
		Connection type											
		Ethernet connection	Direct CPU connection (serial)	Serial communication connection	CC-Link IE TSN connection	CC-Link IE Controller Network connection	CC-Link IE Field Network connection	CC-Link connection (intelligent device station) *1	CC-Link connection (via G4)	Bus connection	MELSECNET/H connection	MELSECNET/10 connection *2	Multi-drop connection
F Series	CR750-Q (Q172DRCPU)	○ *3	○ *4	○	×	○	○	○	○	○	○	○	×
	CR751-Q (Q172DRCPU)	○ *3	○ *4	○	×	○	○	○	○	○	○	○	×
	CR750-D	○	×	×	×	×	×	×	×	×	×	×	×
	CR751-D	○	×	×	×	×	×	×	×	×	×	×	×
SQ Series	CRnQ-700 (Q172DRCPU)	○ *3 *8	○ *4	○ *10	×	○ *12	○	○ *16	○	○	○	○	×
SD Series	CRnD-700	○	×	×	×	×	×	×	×	×	×	×	×
FR Series	CR800-D	○ *6	×	×	×	×	×	×	×	×	×	×	×
	CR800-R (R16RTCPU)	○ *7	×	○ *9	×	○ *11	○ *13	○ *15	×	×	×	×	×
	CR800-Q (Q172DSRCPU)	○ *8	○ *4	○ *10	×	○ *12	○ *14	○ *16	○	○	○	○	×

- *1 Connect the GOT as a CC-Link intelligent device station.
- *2 Only supports the case where MELSECNET/H is used in the MELSECNET/10 mode. Connection to the remote I/O network is not allowed.
- *3 The Display I/F of CRnQ-700, CR750/751-Q cannot be used. Ethernet connections can be established only via the Ethernet module (QJ71E71) or the built-in Ethernet port in the multiple CPU system (OnUDE).
- *4 Access via the serial port (RS-232) of QCPU in the multiple CPU system since CRnQ-700, CR750/751-Q, and CR800-Q have no serial ports.
- *5 GT23, GT21 and GS21-W-N support connection using Ethernet connection, direct CPU connection (serial), serial communication connection, or CC-Link connection (via G4).
- *6 Ethernet connections can be established to the built-in LAN port of CR800-D.
- *7 The communication module RJ71EN71 can be used. Use firmware version 12 or higher when building a redundant system.
- *8 The communication module QJ71E71-100, QJ71E71-B5, QJ71E71-B2, or QJ71E71 can be used.
- *9 The communication module RJ71C24, RJ71C24-R2, or RJ71C24-R4 can be used. Use firmware version 07 or higher when building a redundant system.
- *10 The communication module QJ71C24, QJ71C24-R2, QJ71C24N, QJ71C24N-R2, QJ71C24N-R4, QJ71CMO, or QJ71CMON can be used.
When using QJ71C24 or QJ71C24-R2, either CH1 or CH2 can be used for the function version A. Both CH1 and CH2 can be used together for the function version B or later.
When using QJ71CMO or QJ71CMON, only CH2 can be connected.
- *11 The communication module RJ71GP21-SX can be used. Use firmware version 12 or higher when building a redundant system.
- *12 The communication module QJ71GP21-SX or QJ71GP21S-SX can be used. When the CC-Link IE Controller Network is in the extended mode, use a unit with the upper five digits of the serial No. 12052 or later.
- *13 The communication module RJ71GF11-T2, RJ71EN71, RD77GF4, RD77GF8, RD77GF16, or RD77GF32 can be used.
When using RJ71GF11-T2 or RJ71EN71, use firmware version 12 or higher to build a redundant system.
- *14 The communication module QJ71GF11-T2, QD77GF4, QD77GF8, or QD77GF16 can be used.
- *15 The communication module RJ61BT11 can be used. Use firmware version 4 or higher when building a redundant system.
- *16 The communication module QJ61BT11 or QJ61BT11N can be used.

◆ Mitsubishi Electric CNCs

Series	GT27/GT25/GT23 *6											
	Connection type											
	Ethernet connection	Direct CPU connection (serial)	Serial communication connection	CC-Link IE TSN connection	CC-Link IE Controller Network connection	CC-Link IE Field Network connection	CC-Link connection (intelligent device station) *1	CC-Link connection (via G4)	Bus connection	MELSECNET/H connection	MELSECNET/10 connection *2	Multi-drop connection
CNC C80 (R16NCCPU-S1) *7	○ *10	×	○ *12	×	○ *14	○ *16	○ *18	×	×	×	×	×
CNC C70 (Q173NCCPU) *3	○ *11	○ *4	○ *13	×	○ *15	○ *17	○ *19	○	○	○	○	×
CNC M700VS	×	×	×	×	×	×	○ *5	×	×	×	×	×
CNC M70V	×	×	×	×	×	×	○ *5	×	×	×	×	×
CNC M800/M80	×	×	×	×	×	×	○ *8 *9	×	×	×	×	×

- *1 Connect the GOT as a CC-Link intelligent device station.
- *2 Includes the connection where MELSECNET/H is used in the MELSECNET/10 mode. Connection to the remote I/O network is not allowed.
- *3 When using a CNC C70, the CNC monitor function, the CNC data I/O function, and the CNC machining program edit function can be used in bus connection and Ethernet connection (Display I/F connection only). The above functions are supported by the GOT models of which resolution is SVGA or higher.
- *4 Access via the serial port (RS-232) of QCPU in the multiple CPU system since CNC C70 has no serial port.
- *5 Only cyclic transmission can be used. (CC-Link unit FCU7-HN746 can be used)
- *6 GT23 supports connection using Ethernet connection, direct CPU connection (serial), serial communication connection, or CC-Link connection (via G4).
- *7 When using a CNC C80, the CNC monitor2 function can be used in Ethernet connection (Display I/F connection only).
- *8 Only cyclic transmission can be used. (CC-Link unit FCU8-EX561(WN561) can be used)
- *9 When using M800S/M80, connect FCU8-EX561(WN561) to the relay module for communication extension (FCU8-EX702, or FCU8-EX703).
- *10 The communication module RJ71EN71 can be used. Use firmware version 12 or later when building a redundant system.
- *11 The communication module QJ71E71-100, QJ71E71-B5, QJ71E71-B2, or QJ71E71 can be used.
- *12 The communication module RJ71C24, RJ71C24-R2, or RJ71C24-R4 can be used. Use firmware version 07 or higher when building a redundant system.
- *13 The communication module QJ71C24, QJ71C24-R2, QJ71C24N, QJ71C24N-R2, QJ71C24N-R4, QJ71CMO, or QJ71CMON can be used.
When using QJ71C24 or QJ71C24-R2, either CH1 or CH2 can be used for the function version A. Both CH1 and CH2 can be used together for the function version B or later.
When using QJ71CMO or QJ71CMON, only CH2 can be connected.
- *14 The communication module RJ71GP21-SX can be used. Use firmware version 12 or higher when building a redundant system.
- *15 The communication module QJ71GP21-SX or QJ71GP21S-SX can be used. When the CC-Link IE Controller Network is in the extended mode, use a unit with the upper five digits of the serial No. 12052 or later.
- *16 The communication module RJ71GF11-T2, RJ71EN71, RD77GF4, RD77GF8, RD77GF16, or RD77GF32 can be used.
When using RJ71GF11-T2 or RJ71EN71, use firmware version 12 or higher to build a redundant system.
- *17 The communication module QJ71GF11-T2, QD77GF4, QD77GF8, or QD77GF16 can be used.
- *18 The communication module RJ61BT11 can be used. Use firmware version 4 or higher when building a redundant system.
- *19 The communication module QJ61BT11 or QJ61BT11N can be used.

◆ Mitsubishi Electric power monitoring products

Series	Model name	GT27/GT25/GT23/GT21/GS21-W-N *2			
		RS-485	RS-422	RS-232	Multi-drop connection
Energy measuring unit EcoMonitorLight	EMU4-BD1-MB	○ (2-wire type *1)	×	×	×
	EMU4-HD1-MB	○ (2-wire type *1)	×	×	×
Energy measuring unit EcoMonitorPlus	EMU4-BM1-MB	○ (2-wire type *1)	×	×	×
	EMU4-HM1-MB	○ (2-wire type *1)	×	×	×
	EMU4-LG1-MB	○ (2-wire type *1)	×	×	×
Electronic multi-measuring instrument	ME110SSR-MB	○ (2-wire type *1)	×	×	×
	ME96NSR-MB	○ (2-wire type *1)	×	×	×

- *1 Only MODBUS®/RTU connection is supported. Use the MODBUS®/RTU master communication driver.
- *2 Except GT2103-PMBS2 and GT2103-PMBSL.

Specifications

Connectable model list (GOT2000/GOT SIMPLE)

■ Applicable GOT models for each connection type

The GOT to be used differs depending on the connection type.

Model	Connection type	Applicable model	
GT27/GT25	RS-232	All models (Built-in interfaces of the GOT can be used.)	
	RS-422/485		
	Ethernet		
	CC-Link (via G4)		
GT27/GT25	Other than above	GT27 all models GT25 models excluding some models (By mounting communication units on the GOT, bus connection, network connection, and others can be used. No communication units can be mounted on GT2512-WXTBD, GT2512-WXTSD, GT2510-WXTBD, GT2510-WXTSD, GT2507-WTBD, GT2507-WTSD, GT2507T-WTSD, GT2505-VTBD, GT2506HS-VTBD, and GT2506HS-VTSD.)	
GT23	RS-232	All models (Built-in interfaces of the GOT can be used.)	
	RS-422/485		
	Ethernet		
	CC-Link (via G4)		
GT21/GS21-W-N	RS-232	GT2107-WTBD GT2107-WTSD GT2104-RTBD GT2103-PMBDS	GT2103-PMBDS2 GS2110-WTBD-N GS2107-WTBD-N
	RS-422/485	GT2107-WTBD GT2107-WTSD GT2104-RTBD GT2103-PMBD	GT2103-PMBDS GT2103-PMBLS *1 GS2110-WTBD-N GS2107-WTBD-N
	Ethernet	GT2107-WTBD GT2107-WTSD GT2104-RTBD	GT2103-PMBD GS2110-WTBD-N GS2107-WTBD-N
	CC-Link (via G4)	GT2107-WTBD GT2107-WTSD GT2104-RTBD GT2103-PMBD	GT2103-PMBDS GT2103-PMBDS2 GS2110-WTBD-N GS2107-WTBD-N

*1 Only connection with MELSEC IQ-F Series and MELSEC-F Series is supported.

For the details of the connection configuration, please refer to the GOT2000 Series Connection Manual.

◆ Non-Mitsubishi programmable controllers/Motion controllers/Safety controllers

Manufacturer		Model name		GT27/GT25/GT23/GT21/GS21-W-N ^{*1}						
				Ethernet connection	Direct CPU connection (serial)		Serial communication connection		EtherNet/IP connection	
					RS-422	RS-232	RS-422	RS-232		
OMRON Corporation	SYSMAC CJ1	CJ1H	CJ1M	○	×	○	○ ^{*4}		×	
		CJ1G		○	×	○	○ ^{*4}		×	
	SYSMAC CJ2	CJ2H	CJ2M	○	×	○	○ ^{*4}		×	
		CJ2M		○	×	○ ^{*5}	○ ^{*4}		×	
	SYSMAC CPM	CPM1	CPM1A	×	×	×	×	○	×	
		CPM2A		×	×	○	×	○	×	
		CPM2C		×	×	×	×	○	×	
	SYSMAC CQM1	CQM1	CQM1H	×	×	○ ^{*8}	×	×	×	
	SYSMAC CQM1H	CQM1H		×	×	○	×	×	×	
	SYSMAC CP1	CP1H	CP1L	×	×	×	×	○	×	
		CP1E (N type)		×	×	○ ^{*6}	○ ^{*6,7}	○ ^{*6,7}	×	
	SYSMAC CP2	CP2E	CS1D ^{*3}	○	×	○	○	○	×	
	SYSMAC CS1	CS1H CS1G		○	×	○	○	○	×	
		SYSMAC CVM1/CV ^{*9}	CVM1-CPU11-V□ CVM1-CPU01-V□ CV500-CPU01-V□	CV1000-CPU01-V□ CV2000-CPU01-V□	×	○ ^{*4}		×	×	×
		SYSMAC C200HS	C200HS		×	×	×	○	○	×
		SYSMAC C200H	C200H		×	×	×	○	○	×
		SYSMAC C1000H	C1000H		×	×	×	○ ^{*4}		×
		SYSMAC C2000H	C2000H		×	×	×	○ ^{*4}		×
		SYSMAC α	C200HX	C200HE	×	×	○	○	○	×
			C200HG		○	○	○	○	○	×
	NJ	NJ501-□□□□ NJ101-□□□□	NJ301-□□□□	×	×	×	×	×	○	
	NX	NX1P2-□□□□□□□□	NX701-□□□□	×	×	×	×	×	○	
		NX102-□□□□		×	×	×	×	×	○	
KEYENCE CORPORATION	KV-8000	KV-8000	KV-5500	○	○	○	○	○	×	
		KV-7000		○	○	○	○	○	×	
		KV-5000		○	×	×	○	○	×	
		KV-3000		○	×	○	○	○	×	
		KV-1000		○	×	○	○	○	×	
		KV-700		○	×	○	○	○	×	
		KV-N14□□		×	×	○	○	○	×	
		KV Nano		KV-N24□□ KV-N60□□	KV-N40□□ KV-NC32T	○	×	○	○	○
KOYO ELECTRONICS INDUSTRIES CO., LTD. ^{*2}	DirectLOGIC 05 Series	D0-05AA D0-05AD D0-05AR D0-05DA	D0-05DD D0-05DD-D D0-05DR D0-05DR-D	×	×	○	○	○	×	
		D0-06DD1 D0-06DD2 D0-06DR D0-06DA D0-06AR	D0-06AA D0-06DD1-D D0-06DD2-D D0-06DR-D	×	○	○	○	○	×	
		D2-240		×	×	○	○	○	×	
		D2-250-1	D2-260	×	○	○	○	○	×	
	KOSTAC SU Series	SU-5E SU-6B	SU-5M SU-6M	×	○	○	○	○	×	
PZ Series	PZ3		×	○	○	×	×	×		
Sharp Corporation ^{*2}	JW-21CU JW-31CUH	JW-21CU	JW-50CUH	×	×	×	○	×	×	
		JW-22CU		JW-70CUH	×	○ ^{*4}		○	×	×
		JW-32CUH		JW-100CUH	×	○ ^{*4}		○	×	×
		JW-33CUH		JW-100CU	×	○ ^{*4}		×	×	×
		Z-512J			×	○ ^{*4}		×	×	×
JTEKT CORPORATION ^{*2}	TOYOPLC Series	PC2JC-CPU PC2J16P-CPU	PC2J16PR-CPU	×	×	○ ^{*10}	○	○ ^{*10}	×	
		PC2J-CPU PC2JS-CPU	PC2JR-CPU	×	×	×	○	○ ^{*10}	×	
		PC3JG-P-CPU	PC3JG-CPU	×	×	○ ^{*10}	○	○ ^{*10}	×	
		PC3JD-CPU	PC3JD-C-CPU	×	×	○ ^{*10}	○	○ ^{*10}	×	
		PC3J-CPU	PC3JL-CPU	×	○	○ ^{*10}	○	○ ^{*10}	×	
		PC10G-CPU		×	○	○ ^{*10}	○	○ ^{*10}	×	
TOSHIBA CORPORATION ^{*2}	PROSEC T Series	T2 (PU224)	5	×	○	×	×	×	×	
		T3	T2N	×	○ ^{*4}		×	×	×	
		T3H		×	○	×	×	×	×	
		model 2000 (S2E) model 2000 (S2T)	model 2000 (S2) model 3000 (S3)	×	○	×	×	×	×	
Unified Controller nv Series	PUB11			○	×	×	×	×	×	
	PUM11	PUM14		○	×	×	×	×	×	
	PUM12			○	×	×	×	×	×	
SHIBAURA MACHINE CO., LTD.	TCmini Series	TC3-01	TC6-00	×	×	○	×	×	×	
		TC3-02	TC8-00	×	×	○	×	×	×	
		TC5-02	TC5-03	×	○ ^{*20}	×	×	×	×	
Robot controller	TS2000	TS2100	×	×	○	×	×	×		
HITACHI Industrial Equipment Systems Co., Ltd. ^{*2}	EHV Series	EHV-CPU08 EHV-CPU16 EHV-CPU32	EHV-CPU64 EHV-CPU128	○	×	×	×	×	×	
		MVH-A40□□□ MVH-D40□□□	MVH-A64□□□ MVH-D64□□□	○	×	×	×	×	×	
		H-300 H-302 H-700 H-702	H-1002 H-2000 H-2002 H-4010	×	×	○	○ ^{*4}		×	
	H-200 to 252 Series	H-200 H-250 H-252	H-252B H-252C	×	×	○	×	×	×	
	H Series board type	HL-40DR HL-64DR H-20DR H-20DT H-28DR	H-28DT H-40DR H-40DT H-64DR H-64DT	×	×	○	×	×	×	
	EH-150 Series	EH-CPU104 EH-CPU208 EH-CPU308	EH-CPU316 EH-CPU516 EH-CPU548	×	×	○	×	×	×	

Specifications

Connectable model list (GOT2000/GOT SIMPLE)

◆ Non-Mitsubishi programmable controllers/Motion controllers/Safety controllers

Manufacturer		Model name	GT27/GT25/GT23/GT21/GS21-W-N ^{*1}							
			Ethernet connection	Direct CPU connection (serial)		Serial communication connection		EtherNet/IP connection		
				RS-422	RS-232	RS-422	RS-232			
Hitachi Ltd. ^{*2}	S10V	LQP510	×	○	×	○	○	×		
		LQP520	×	×	×	○	○	×		
	S10VE NEW	LQP600	○	×	×	×	×	×		
		LQP000 LQP010 LQP011	×	×	×	○	○	×		
FUJII ELECTRIC CO., LTD. ^{*2}	MICREX-F	F55 F120S F140S	×	×	×	○	○	×		
	MICREX-SX SPH	SPH200 SPH2000	○	×	○	○	○	×		
Panasonic Industrial Devices SUNX Co., Ltd.	FP0R FP0-C16CT FP0-C32CT	F70 F15□S	×	×	○	×	×	×		
		FP5 FP10 (S) FP10SH	×	×	○	×	○	×		
		FP Σ	×	×	○	×	×	×		
	FP-M (C20T) FP-M (C32T)	FP-X	×	×	○	○	○	×		
		FP7	×	×	○	○	○	×		
		FP0H NEW	×	×	○	×	○	×		
		FP-XH NEW	×	○	○	×	×	×		
		GL120 GL60S GL60H	GL130 GL70H	×	×	○ ^{*2}	○ ^{*2}	×	×	
		CP-9200SH	×	×	×	×	○	×		
		CP-9300MS	×	×	○ ^{*2}	×	×	×		
MP920 MP930 MP940	×	×	○	×	×	×				
PROGIC-8 CP-9200 (H)	×	×	○ ^{*2}	×	×	×				
CP-312 CP-317	○	×	×	×	○	×				
MP2200 MP2300	MP2300S	○	×	×	○	○	×			
MP3200 MP3300	×	×	×	×	×	×				
Yokogawa Electric Corporation ^{*2}	FA500	FA500	×	×	×	○ ^{*4}	○	×		
		F3SP05 F3SP10 F3SP20 F3FP36	F3SP08 F3SP30	○	×	○	○	○	×	
		F3SP21 F3SP25 F3SP28 F3SP35 F3SP66	F3SP38 F3SP53 F3SP58 F3SP59 F3SP67	○	×	○	○	○	×	
	FA-M3	F3SP22-0S F3SP71-4N	×	×	○	×	×	×		
		F3SP71-4S F3SP76-7S	○	×	×	○	○	×		
		STARDOM	NFCP100 NFJT100	○ ^{*14}	×	○	×	×	×	
	Allen-Bradley (Rockwell Automation, Inc.)	SLC500 Series ^{*11}	SLC500-20 SLC500-30 SLC500-40	SLC5/01 SLC5/02	×	×	○ ^{*2}	×	×	×
			SLC5/03 SLC5/04	SLC5/05	×	×	○	×	×	×
			MicroLogix1000 Series (digital CPU) ^{*11 *12 *13}	1761-L10BWA 1761-L10BWB 1761-L16AWA 1761-L16BWA 1761-L16BWB 1761-L16BBB	1761-L32AAA 1761-L32AWA 1761-L32BWA 1761-L32BWB 1761-L32BBB	○ ^{*15}	×	○	×	×
		MicroLogix1000 Series (analog CPU) ^{*11}	1761-L20AWA-5A 1761-L20BWA-5A	1761-L20BWB-5A	○ ^{*15}	×	○	×	×	×
		MicroLogix1100 Series ^{*11}	1763-L16BWA	×	×	○	×	×	×	
		MicroLogix1200 Series ^{*11}	1762-L24BWA	×	×	○	×	×	×	
MicroLogix1400 Series ^{*11}		1766-L32AWA	×	×	○	×	×	×		
MicroLogix1500 Series ^{*11}		1764-LSP	1764-LRP	○ ^{*15}	×	○	×	×	×	
ControlLogix Series		1756-L 1756-L1M1	1756-L1M2 1756-L1M3	○ ^{*15}	×	○ ^{*2}	×	×	○ ^{*21}	
		1756-L5M12 1756-L5M13 1756-L5M14 1756-L5M16	1756-L5M22 1756-L5M23 1756-L5M24	○ ^{*15}	×	○ ^{*2}	×	×	○ ^{*21}	
		1756-L61 1756-L62	1756-L63 1756-L64	○ ^{*15}	×	○ ^{*2}	×	×	○ ^{*21}	
		1756-L72S	×	×	×	×	×	○ ^{*21}		
		1756-L71 1756-L72 1756-L73	1756-L74 1756-L75	○ ^{*15}	×	×	×	×	○ ^{*21}	
		1756-L81E 1756-L82E 1756-L83E	1756-L84E 1756-L85E	○ ^{*15}	×	×	×	×	○ ^{*21}	
		1769-L31 1769-L32C 1769-L35CR	×	×	○ ^{*2}	×	×	×	×	
CompactLogix Series	1769-L32E 1769-L35E	×	×	○ ^{*2}	×	×	○ ^{*21}			
FlexLogix Series ^{*2}	1794-L33 1794-L34	×	×	○	×	×	○ ^{*16}			

For the details of the connection configuration, please refer to the GOT2000 Series Connection Manual.

Manufacturer		Model name	GT27/GT25/GT23/GT21/GS21-W-N *1						
			Ethernet connection	Direct CPU connection (serial)		Serial communication connection		EtherNet/IP connection	
				RS-422	RS-232	RS-422	RS-232		
GE Intelligent Platforms, Inc. *2	Series 90-30	IC693CPU311 IC693CPU313 IC693CPU323	×	×	×	○	○	×	
		IC693CPU350 IC693CPU360 IC693CPU363	×	○	×	○	○	×	
		IC697CGR772 IC697CGR935 IC697CPM790 IC697CPU731 IC697CPU780 IC697CPU788 IC697CPU789	×	×	×	○	○	×	
	VersaMax Micro	IC200UAA003	×	○	○	×	×	×	
		IC200UAR014 IC200UDD104 IC200UDD112	×	×	○	×	×	×	
		IC200UAA007 IC200UAL004 IC200UAL005 IC200UAL006 IC200UAR028 IC200UDD064 IC200UDD164 IC200UDD110	×	○	○	×	×	×	
		IC200UDD120 IC200UDD212 IC200UDR005 IC200UDR006 IC200UDR010 IC200UDR064 IC200UDR164							
	LS Industrial Systems Co., Ltd.	K300S	K4P-15AS	×	×	×	○	○	×
		K200S	K3P-07□S	×	×	×	○	○	×
		K120S	K7M-D□□□□	×	×	○	○	○	×
K80S		K7M-D□□□□S (DC)	×	×	○	○	○	×	
XGT NEW		XGK-CPUU XGK-CPUH XGK-CPUA XGK-CPUS	○	×	×	×	×	×	
Mitsubishi Electric India Pvt. Ltd.	Nexgenie 2000 PLC	P2210 P2211	×	○	○	×	×	×	
	Nexgenie 1000 PLC	NG14RL NG14RN NG16ADL NG16ADN	×	○	○	×	×	×	
Schneider Electric SA	Twido Series		○ *14	×	×	×	×	×	
	Modicon Premium Series		○ *14	×	×	×	×	×	
	Modicon Quantum Series		○ *14	×	×	×	×	×	
SICK AG	Flexi Soft Series	FX3-CPU000000 FX3-CPU130002	×	×	○	×	×	×	
Siemens AG	SIMATIC S7-200 Series		○ *17	×	○	×	×	×	
	SIMATIC S7-200 SMART Series NEW		○ *17	×	○ *22	×	×	×	
	SIMATIC S7-300 Series		○ *19	×	○	×	×	×	
	SIMATIC S7-400 Series		○ *19	×	○	×	×	×	
	SIMATIC S7-1200 Series		○ *17	×	×	×	×	×	
SIMATIC S7-1500 Series NEW		○ *17	×	×	×	×	×		
SMC Corporation	LECA6	LECP6	×	○ *18	×	×	×	×	

*1 Select an appropriate GT21 model depending on the connection type. For the details of applicable GOT models for each connection type, please refer to page 186.
 *2 GT21 and GS21-W-N cannot be connected.
 *3 Connectable only when a single communication unit is used in a single CPU system.
 *4 Either RS-422 or RS-232 can be selected.
 *5 Only CJ2M-CPU1□ can be connected.
 *6 Connection is not available with the E type CP1E.
 *7 For CP1E (N type) CPU modules with 20 or less I/O points, only the direct CPU connection (serial) is available.
 *8 The COM1-CPU11 is unable to communicate with GOT since the COM1-CPU11 has no RS-232 interface.
 *9 SYSMAC CVM1/CV can be used with a CPU version 1 or later.
 *10 An RS-232/RS-422 interface converter (TXU-2051) is required.
 *11 Connection to DH485 network is available via adapter (1770-KF3).
 *12 DH485 connection can be used with a CPU in the series C or later. (DH485 protocol is not supported by a CPU in the series B or earlier.)

*13 One-to-one connection is supported by a CPU in the series D or later. (DF1 half duplex is not supported by a CPU in the series C or earlier.)
 *14 Only MODBUS®/TCP connection is supported. Use the MODBUS®/TCP master communication driver.
 *15 EtherNet/IP (PCCP protocol) is supported.
 *16 Use EtherNet/IP Tag.
 *17 Only OP communication can be used in Ethernet connection of the S7-200 Series, the S7-200 SMART Series, the S7-1200 Series, and the S7-1500 Series.
 *18 Only MODBUS®/RTU connection is supported. Use the MODBUS®/RTU master communication driver.
 *19 Only OP communication can be used on GT21 and GS21-W-N.
 *20 Only RS-485 is supported.
 *21 GT21 and GS21-W-N do not support EtherNet/IP Tag.
 *22 GT27, GT25, and GT23 cannot be connected.

■ Modules usable when connected with non-Mitsubishi controllers in serial communication connection, Ethernet connection, EtherNet/IP connection

Manufacturer		Ethernet	RS-422	RS-232	EtherNet/IP
OMRON Corporation	Host link unit Communication unit Communication board Ethernet module	CJ1W-EIP21 CJ1W-ETN21 CS1D-ETN21D CS1W-EIP21 CS1W-ETN21	CJ1W-SCU31-V1 CJ1W-SCU41(-V1) CP1W-CIF11 CP1W-CIF12 COM1-SCB41 CS1W-SCB41(-V1) C200H-LK202-V1 C200HW-COM03 C200HW-COM06 C500-LK201-V1	CJ1W-SCU21(-V1) CJ1W-SCU41(-V1) CPM1-CIF01 CPM2C-CIF01-V1 CP1W-CIF01 COM1-CIF02 COM1-SCB41 CS1W-SCB21(-V1) CS1W-SCB41(-V1) CS1W-SCU21(-V1) C200HW-COM02 C200HW-COM05 C200HW-COM06 C200H-LK201-V1 C500-LK201-V1	CJ1W-EIP21
KEYENCE CORPORATION	Multi-communication unit Ethernet module	KV-LE20V KV-LE21V KV-EP21V KV-NC1EP *3	KV-L20 KV-L20R KV-L20V KV-NC20L KV-N11L	KV-L20 KV-L20R KV-L20V KV-NC10L KV-NC20L KV-N10L	—
KOYO ELECTRONICS INDUSTRIES CO., LTD.	Data communications module Host link module	—	D0-DCM D2-DCM U-01DM	D0-DCM D2-DCM U-01DM	—

Specifications

Connectable model list (GOT2000/GOT SIMPLE)

■ Modules usable when connected with non-Mitsubishi controllers in serial communication connection, Ethernet connection, EtherNet/IP connection

Manufacturer		Ethernet	RS-422	RS-232	EtherNet/IP
Sharp Corporation	Link unit	—	JW-10CM JW-21CM ZW-10CM	—	—
JTEKT CORPORATION	Link unit	—	THU-2755 THU-2927 THU-5139 TCU-6903 NEW	—	—
Hitachi Industrial Equipment Systems Co., Ltd.	Intelligent serial port module Network module	EH-ETH/ETH2 NEW EH-ELK NEW EH-ORML NEW EH-R2LH/OR2LH NEW	COMM-H COMM-2H	COMM-H COMM-2H	—
Hitachi, Ltd.	Communication module	LQE260-E NEW	LQE165 LQE565	LQE060 LQE160 LQE560	—
FUJII ELECTRIC CO., LTD.	RS-232C interface card	—	—	NV1L-RS2	—
	RS-232C/485 interface capsule		FFK120A-C10	FFK120A-C10	
	General-purpose interface module Communication module		FFU120B NC1L-RS4	FFU120B NC1L-RS2	
			NP1L-RS1 NP1L-RS2 NP1L-RS3	NP1L-RS1 NP1L-RS4 NP1L-RS5	
Ethernet interface module	NP1L-ET1	—	—		
Panasonic Industrial Devices SUNX Co., Ltd.	Computer communication unit Communication cassette	—	AFPX-COM3 AFP7CCM1 AFP7COM2 AFP7CCS1M1	AFPG801 AFPG802 AFPX-COM1 AFPX-COM2 AFPX-COM4 AFP2462 AFP3462 AFP5462 AFP7CCS1 AFP7CCS2 AFP7CCS1M1 AFP0HCCS1 AFP0HCCS2 AFP0HCCS1M1	—
YASKAWA Electric Corporation	MEMOBUS module Communication module	CP-218IF 218IF 218IF-01 218IF-02 *1 218TXB	JAMSC-IF612 JAMSC-120NOM27100 217IF 217IF-01	CP-217IF JAMSC-IF60 JAMSC-IF61 217IF 217IF-01 218IF-01 218IF-02 *1	—
Yokogawa Electric Corporation	PC link module Ethernet interface module	F3LE01-5T F3LE11-0T F3LE12-0T	F3LC11-2N F3LC11-2F LC02-0N	F3LC01-1N F3LC11-1F F3LC11-1N F3LC12-1F LC01-0N LC02-0N	—
Allen-Bradley (Rockwell Automation, Inc.)	EtherNet/IP communication module	1756-ENBT 1756-ENET 1756-EN2T 1756-EN2TR 1756-EN3TR 1756-EN2TSC 1761-NET-ENI	—	—	1756-ENBT 1756-ENET *2 1756-EN2T 1756-EN2TR 1756-EN3TR 1756-EN2TSC 1788-ENBT/A
GE Intelligent Platforms, Inc.	Communication module	—	IC693CMM311 IC697CMM711	IC693CMM311 IC697CMM711	—
LS Industrial Systems Co., Ltd.	Cnet I/F unit	—	G7L-CUEC	G7L-CUEB	—
	Cnet I/F module	—	G4L-CUEA G6L-CUEC	G4L-CUEA G6L-CUEB	—
	Ethernet module NEW	XGL-EFMT(B)	—	—	—
Schneider Electric SA	Ethernet module	TSX ETY 4102 TSX ETY 5102 140 NOE 771 00 140 NOE 771 10 140 NWM 100 00	—	—	—
Siemens AG	Ethernet module	CP 243-1 CP 243-1 IT CP 343-1 CP 343-1 Advanced CP 343-1 Advanced-IT CP 343-1 IT CP 343-1 Lean CP 443-1 CP 443-1 IT CP 443-1 Advanced-IT	—	—	—

*1 When connecting MP2200, MP2300, or MP2300S using Ethernet connection or RS-232 connection, use a CPU of the software version 2.60 or later.

*2 Use an EtherNet/IP communication module 1756-ENET of the version B or later.

*3 When using KV-24□□, 40□□, or 60□□, a connection conversion unit (KV-N1) is required.

◆ Servo amplifiers

Manufacturer	Model name	GT27/GT25/GT23	
		RS-485	RS-232
Panasonic Corporation	MINAS A4 Series	○	○
	MINAS A4F Series	○	○
	MINAS A4L Series	○	○
	MINAS A5 Series	○	○

For the details of the connection configuration, please refer to the GOT2000 Series Connection Manual.

◆ Robot controllers

Manufacturer		Model name			GT27/GT25/GT23/GT21/GS21-W-N			
					RS-422	RS-232	Ethernet	
IAI Corporation X-SEL controller	ROBO CYLINDER RCA Series dedicated program controller	ASEL	ASEL		×	○	×	
	ROBO CYLINDER RCP2 Series dedicated program controller	PSEL	PSEL		×	○	×	
	Single-axis robot/linear servo/ ROBO CYLINDER RCS2 program controller	SSEL	SSEL		×	○	×	
	Single-axis, multi-axis robot controller	X-SEL	XSEL-J XSEL-K XSEL-KE XSEL-KET	XSEL-KT XSEL-P XSEL-Q	×	○	×	
	SCARA robot controller	X-SEL	XSEL-JX XSEL-KTX XSEL-KX	XSEL-PX XSEL-QX	×	○	×	
IAI Corporation ROBO CYLINDER	RCA2/RCA Series positioner controller	ACON	ACON-C ACON-CG ACON-CY	ACON-PL ACON-PO ACON-SE	○	○	×	
	RCA2/RCA Series positioner controller supporting battery-less absolute encoder NEW		ACON-CB					
	ERC2 built-in positioner controller	ERC2	ERC2		○	○	×	
	RCP3/RCP2 Series positioner controller	PCON	PCON-C PCON-CA *1 PCON-CF PCON-CFA *1 PCON-CG	PCON-CY PCON-PL PCON-PO PCON-SE	○	○	×	
	RCP6/RCP5/RCP4 <supporting PowerCon> / RCP3/RCP2 Series positioner controller NEW		PCON-CB	PCON-CFB				
	RCS2 Series positioner controller	SCON	SCON-C		○	○	×	
	RCS4/RCS3/RCS2 Series positioner controller supporting battery-less absolute encoder NEW		SCON-CA					
	RCP2/3/4/5/6, PCA/2, RCD, RCL Series unit-connecting position controller NEW	RCON	RCON-GW(GWG)-CC RCON-GW(GWG)-CIE RCON-GW(GWG)-DV	RCON-GW(GWG)-EP RCON-GW(GWG)-PR RCON-GW(GWG)-PRT	○	○	×	
IAI Corporation ELECYLINDER *2 NEW	Slider	EC *3	EC-S3 EC-S4	EC-S6 EC-S7	○	○	×	
	Slider (side-mounted motor type)		EC-S6□R EC-S7□R		○	○	×	
	High-rigidity slider		EC-S6□AH EC-S7□AH		○	○	×	
	High-rigidity slider (side-mounted motor type)		EC-S6□AHR EC-S7□AHR		○	○	×	
	Rod		EC-R6 EC-R7		○	○	×	
	Mini rod		EC-RP4 EC-GS4	EC-GD4	○	○	×	
	Radial cylinder		EC-RR3 EC-RR4	EC-RR6 EC-RR7	○	○	×	
	Radial cylinder (side-mounted motor type)		EC-RR6□R EC-RR7□R		○	○	×	
	High-rigidity radial slider		EC-RR6□AH EC-RR7□AH		○	○	×	
	High-rigidity radial slider (side-mounted motor type)		EC-RR6□AHR EC-RR7□AHR		○	○	×	
	Mini table		EC-TC4 EC-TW4		○	○	×	
	Rod		EC-R6□W EC-R7□W		○	○	×	
	Radial cylinder NEW		EC-RR6□W	EC-RR7□W	○	○	×	
	Belt driven type		EC-B6 EC-B6U	EC-B7 EC-B7U	○	○	×	
	Slider (side-mounted motor type)		EC-S3R EC-S4R		○	○	×	
	Radial cylinder (side-mounted motor type)		EC-RR3R		○	○	×	
	Radial cylinder (side-mounted motor type)		EC-RR4R		○	○	×	
	Stopper cylinder		EC-ST15		○	○	×	
	Rotary		EC-RTC9	EC-RTC12	○	○	×	
	Slider		EC-S13 EC-S13X	EC-S15 EC-S15X	○	○	×	
	High-rigidity radial slider		EC-RR6X□AH	EC-RR7X□AH	○	○	×	
	Wide slider		EC-WS10	EC-WS12	○	○	×	
	Mini rod		EC-GD5	EC-RP5	○	○	×	
	Mini table		EC-TC5	EC-TW5	○	○	×	
	Slider		EC-S6□CR EC-S7□CR	EC-S6AH□CR EC-S7AH□CR	○	○	×	
	High-rigidity slider		EC-S3□CR EC-S4□CR		○	○	×	
	Slider		EC-GRB8M EC-GRB10M	EC-GRB13M EC-GRB13L	○	○	×	
	Gripper		EC-S10	EC-S10X	○	○	×	
	SHIBAUURA MACHINE CO., LTD.		SCARA robot controller	TS2000		×	○	×
				TS2100				
	YASKAWA Electric Corporation *2 NEW		Robot controller	YRC1000		×	×	○

*1 Use PCON-CA or PCON-CFA of V0002 or later.

*2 GT21 and GS21-W-N cannot be connected.

*3 Sample screen data are required for connection with EC series. To obtain sample screen data, contact your local sales office.

For the details of the connection configuration, please refer to the GOT2000 Series Connection Manual.

Manufacturer		Model name		GT27/GT25/GT23/GT21/GS21 -W-N				
				RS-485	RS-422	RS-232	Ethernet	
FUJII ELECTRIC CO., LTD.	Temperature controller	PXF PXG PXR	PXF4/5/9 PXG4/5/9 PXR3/4/5/9	○ (2-wire type *1)	×	○ *2	×	
	Digital controller	PXH	PXH9	○ (2-wire type *1)	×	○ *2	×	
	Multi-loop module type temperature controller	PUM	PUMA/B	○ (2-wire type *1)	×	○ *2	×	
Yokogawa Electric Corporation *12	GREEN Series (UM)	UM330 UM331	UM350 UM351	○ (2-wire type *1)	×	○ *2	×	
	GREEN Series (UP)	UP350 UP351	UP550	○ (2-wire type *1/4-wire type)	×	○ *2	×	
		UP750		○ (2-wire type *1)	×	○ *2	×	
	GREEN Series (US)	US1000		○ (2-wire type *1)	×	○ *2	×	
	GREEN Series (UT)	UT320 UT321 UT350 UT351 UT420	UT450 UT520 UT550 UT551	○ (2-wire type *1/4-wire type)	×	○ *2	×	
		UT750		○ (2-wire type *1)	×	○ *2	×	
		UT100 Series (UP)	UP150		○ (2-wire type *1)	×	○ *2	×
		UT100 Series (UT)	UT130 UT150	UT152 UT155	○ (2-wire type *1)	×	○ *2	×
	UT2000 Series	UT2400	UT2800	○ (4-wire type)	×	○ *2	×	
	UTAdvanced Series (UM)	UM33A		○ (2-wire type *1/4-wire type)	×	○ *2	○ *10	
	UTAdvanced Series (UP)	UP35A UP32A	UP55A	○ (2-wire type *1/4-wire type)	×	○ *2	○ *10	
		UP32A		○ (2-wire type *1/4-wire type)	×	○ *2	×	
	UTAdvanced Series (UT)	UT32A UT35A UT52A	UT55A UT75A	○ (2-wire type *1/4-wire type)	×	○ *2	○ *10	
		UT52A		○ (2-wire type *1)				
FKC INSTRUMENT INC. *12	SR Mini HG	H-PCP-J		○ (2-wire type *1)	○	○	×	
		H-PCP-A		×	○	○	×	
	SRZ	Z-CT		○ (2-wire type *1 *6)	○ *5	○ *2 *3	○ *10	
		Z-DIO						
		Z-TIO						
	CB *7	CB100 CB400 CB500		○ (2-wire type *1)	×	○ *2	×	
		FB100		○ (2-wire type *1/4-wire type)	×	○ *2	○ *10	
		FB400		○ (2-wire type *1/4-wire type)	○	○ *2 *3	○ *10	
	RB	RB100 RB400 RB500		○ (2-wire type *1)	×	○ *2	×	
		PF900		○ (2-wire type *1/4-wire type)	○	○ *2 *3	×	
		PF901		○ (2-wire type *1/4-wire type)	○	○ *2 *3	×	
	HA	HA400 HA401		○ (2-wire type *1/4-wire type)	○	○	×	
		HA900 HA901		○ (2-wire type *1/4-wire type)	○	○	×	
	RMC	RMC500		○ (2-wire type *1)	×	○ *2	×	
	MA	MA900		○ (2-wire type *1/4-wire type)	○	○	×	
	AG	AG500		○ (2-wire type *1/4-wire type)	○	×	×	
	THV	THV-A1		○ (2-wire type *1/4-wire type)	○	×	×	
	SA	SA100		○ (2-wire type *1)	×	○ *2	×	
	SRX	X-TIO		○ (2-wire type *1)	×	○ *2	×	
	SB1	SB1		○ (2-wire type *1)	×	○ *2	×	
B400	B400		○ (2-wire type *1)	○	×	×		
FZ	FZ110		○ (2-wire type *1)	×	○ *2	×		
	FZ400		○ (2-wire type *1)	○	○ *2 *3	×		
RZ	RZ100		○ (2-wire type *1)	×	○ *2	×		
PZ	PZ400		○ (2-wire type *1)	○	○ *2	×		
GZ	GZ400		○ (2-wire type *1)	○	○ *2	×		
SRJ	J-TI-A		○ (2-wire type *1)	×	○ *2	×		
		J-TI-B	○ (2-wire type *1)	×	○ *2	×		

*1 GT27/GT25: Use RS-422/485 interface, GT15-RS4-TE, or FA-LTBGT2R4CBLI. GT15-RS4-9S cannot be used.
 *2 If the temperature controller/indicating controller has an RS-485 interface, use an RS-232/RS-485 converter for the manufacturer.
 *3 If the temperature controller/indicating controller has an RS-422 interface, use an RS-232/RS-422 converter for the manufacturer.
 *4 Only the indicating controller equipped with RS-232 communication function can be connected.
 *5 Use a communication extension module (Z-COM).
 *6 Use a communication extension module (Z-COM) depending on the system configuration of the temperature controller.

*7 Select a model that supports the MODBUS® communication function.
 *8 Connectable with the products manufactured in October 2007 or later (Indicating controllers with the serial numbers 07Axxxxxx, 07Kxxxxxx, and 07Xxxxxxx or later).
 *9 Only MODBUS®/RTU connection is supported. Use the MODBUS®/RTU master communication driver.
 *10 Only MODBUS®/TCP connection is supported. Use the MODBUS®/TCP master communication driver.
 *11 Use a serial communication unit SCU.
 *12 GT21 and GS21-W-N cannot be connected.

Specifications

Connectable model list (GOT2000/GOT SIMPLE)

◆ MODBUS® devices

Communication with MODBUS® compatible devices is possible by using the MODBUS®/RTU master or MODBUS®/RTU slave communication driver, or the MODBUS®/TCP master or MODBUS®/TCP slave communication driver.

For the MODBUS® devices, which have been checked for operation, please refer to the Technical Bulletin "List of Valid Devices Applicable for GOT2000 Series MODBUS® Connection" (No. GOT-A-0070) on the Mitsubishi Electric Factory Automation Global website.

◆ PROFIBUS DP devices

Communication with PROFIBUS DP-compliant devices is possible by using the PROFIBUS DP communication driver. (GT27, GT25 only)

For the PROFIBUS DP-compliant devices, please refer to the Technical Bulletin "List of PROFIBUS DP-compliant Equipment Validated to Operate with the GOT2000 Series" (No. GOT-A-0083) on the Mitsubishi Electric Factory Automation Global website.

◆ DeviceNet devices

Communication with DeviceNet-compliant devices is possible by using the DeviceNet communication driver. (GT27, GT25 only)

For the DeviceNet-compliant devices, please refer to the Technical Bulletin "List of DeviceNet-compliant Equipment Validated to Operate with the GOT2000 Series" (No. GOT-A-0084) on the Mitsubishi Electric Factory Automation Global website.

◆ Microcomputer connection

By connecting a personal computer, microcomputer board, programmable controller, etc. to a GOT, the data can be written to or read from virtual devices of the GOT.

◆ SLMP devices

Communication with SLMP compatible devices is possible by using the SLMP communication driver.

For the SLMP devices, which have been checked for operation, please refer to the Technical Bulletin "List of SLMP-compatible Equipment Validated to Operate with the GOT2000 Series" (No. GOT-A-0085) on the Mitsubishi Electric Factory Automation Global website.

◆ CC-Link IE Field Network Basic-compatible devices

Communication with CC-Link IE Field Network Basic-compatible devices is possible by using the Ethernet (CC-Link IE Field Network Basic) communication driver.

The GOT2000 Series operates as a remote station and is connectable to CC-Link IE Field Network Basic-compatible devices that operate as master stations.

For the CC-Link IE Field Network Basic-compatible devices, please refer to the Technical Bulletin "List of CC-Link IE Field Network Basic-compatible Equipment Validated to Operate with the GOT2000 Series" (No. GOT-A-0104) on the Mitsubishi Electric Factory Automation Global website.

■ Applicable GOT models for each connection type

The GOT to be used differs depending on the connection type.

Model	Connection type	Applicable model	
GT27/GT25	RS-232	All models (Built-in interfaces of the GOT can be used.)	
	RS-422/485		
	Ethernet		
	CC-Link (via G4)		
	Other than above	GT27 all models GT25 models excluding some models (By mounting communication units on the GOT, bus connection, network connection, and others can be used. No communication units can be mounted on GT2512-WXTBD, GT2512-WXTSD, GT2510-WXTBD, GT2510-WXTSD, GT2507-WTBD, GT2507-WTSD, GT2507T-WTSD, GT2505-VTBD, GT2506HS-VTBD, and GT2505HS-VTBD.)	
GT23	RS-232	All models (Built-in interfaces of the GOT can be used.)	
	RS-422/485		
	Ethernet		
	CC-Link (via G4)		
GT21/GS21-W-N	RS-232	GT2107-WTBD	GT2103-PMBDS2
		GT2107-WTSD	GS2110-WTBD-N
		GT2104-RTBD	GS2107-WTBD-N
		GT2103-PMBDS	
	RS-422/485	GT2107-WTBD	GT2103-PMBDS
		GT2107-WTSD	GT2103-PMBLS *1
		GT2104-RTBD	GS2110-WTBD-N
		GT2103-PMBD	GS2107-WTBD-N
Ethernet	GT2107-WTBD	GT2103-PMBD	
	GT2107-WTSD	GS2110-WTBD-N	
	GT2104-RTBD	GS2107-WTBD-N	
CC-Link (via G4)	GT2107-WTBD	GT2103-PMBDS	
	GT2107-WTSD	GT2103-PMBDS2	
	GT2104-RTBD	GS2110-WTBD-N	
	GT2103-PMBD	GS2107-WTBD-N	

*1 Only connection with MELSEC iQ-F Series and MELSEC-F Series is supported.

Specifications

- There are two ways of usage of GT SoftGOT2000: GT SoftGOT2000 for single channel connection and GT SoftGOT2000 (Multi-channel) for multi-channel connection. GT SoftGOT2000 (Multi-channel) supports Ethernet connection, connection to OPC UA servers, or connection to microcomputers. Therefore in the following list, Ethernet connection column is separated in two columns: Single (GT SoftGOT2000) and Multi (GT SoftGOT2000 (Multi-channel)). For connection with OPC UA servers or microcomputers, please refer to page 194.
- For the details of the connection configuration, please refer to the GT SoftGOT2000 Version1 Operating Manual.

Series	Model name	Connection type												
		Ethernet connection		Direct CPU connection (RS-232)	Direct CPU connection (USB)	Serial communication connection	CC-Link IE TSN connection	CC-Link IE Controller Network connection	CC-Link IE Field Network connection	MELSEC NET/H connection	MELSEC NET/10 connection ¹			
		Single	Multi											
Programmable controller	MELSEC-F Series	FX0												
		FX0S	×	×	○	×	×	×	×	×	×	×	×	
		FX0N												
		FX1												
		FX1S	×	×	○	×	×	×	×	×	×	×	×	×
		FX1N												
		FX1NC												
		FX2												
		FX2C												
		FX2N	×	×	○	×	×	×	×	×	×	×	×	×
		FX2NC												
		FX3G	○	○ ^{*31}	○	○	×	×	×	×	×	×	×	×
		FX3GC												
		FX3U	○	○ ^{*31}	○	○	×	×	×	×	×	×	×	×
FX3UC														
FX3S	○	○ ^{*31}	○	○	×	×	×	×	×	×	×	×		
FX3GE														
C Controller module	MELSEC IQ-R Series	R12CCPU-V	○ ^{*25}	○ ^{*25}	×	○ ^{*26}	○ ^{*19}	×	○	○	×	×	×	
		Q24DHCCPU-V												
	MELSEC-Q Series	Q24DHCCPU-VG												
		Q24DHCCPU-LS	○	○	○ ^{*18}	○	○ ^{*19}	×	○ ^{*2}	○	○	○	○	
		Q26DHCCPU-LS												
Q12DCCPU-V ^{*20}														
MELSECWinCPU NEW	MELSEC IQ-R Series	R102WCPU-W	×	○	×	×	×	×	×	×	×	×	×	
Safety controller	MELSEC-WS Series	WS0-CPU0												
		WS0-CPU1	×	×	×	×	×	×	×	×	×	×	×	
		WS0-CPU3												
Motion controller	MELSEC IQ-R Series	R16MTCPU	○	○	×	○	○	×	○	○	×	×	×	
		R32MTCPU												
		R64MTCPU												
		Discontinued												
	MELSEC-Q Series	Q172CPU	×	×	×	×	×	×	×	×	×	×	×	×
		Q173CPU	×	×	×	×	×	×	×	×	×	×	×	×
		Q172CPUN	×	×	×	×	×	×	×	×	×	×	×	×
		Q173CPUN	×	×	×	×	×	×	×	×	×	×	×	×
		Q172HCPU	×	×	×	×	×	×	×	×	×	×	×	×
		Q173HCPU	×	×	×	×	×	×	×	×	×	×	×	×
		Q172DCPU	×	×	×	×	×	×	×	×	×	×	×	×
		Q173DCPU												
		Q172DCPU-S1	×	×	×	×	×	×	×	×	×	×	×	×
		Q173DCPU-S1												
		Q172DSCPU	○ ^{*23}	○ ^{*23}	○ ^{*18}	○	○	×	○	×	○ ^{*23}	○ ^{*23}	○ ^{*23}	○ ^{*23}
		Q173DSCPU												
		Q170MCPU ^{*21} ^{*22}	○ ^{*23}	○ ^{*23} ^{*32}	○	○	○	×	○	○ ^{*4}	○ ^{*23}	○ ^{*23}	○ ^{*23}	○ ^{*23}
		Q170MSCPU ^{*22}	○ ^{*23}	○ ^{*23}	○	○	○	×	○	○	○ ^{*23}	○ ^{*23}	○ ^{*23}	○ ^{*23}
Q170MSCPU-S1 ^{*22}														
MR-MQ100	×	×	×	×	×	×	×	×	×	×	×	×		
MELSECNET/H remote I/O station	MELSEC IQ-R Series	QJ72LP25-25												
		QJ72LP25G	×	×	○	×	×	×	×	×	×	×	×	
		QJ72BR15												
CC-Link IE Field Network head module	MELSEC IQ-R Series	RJ72GF15-T2	○	○	×	○	○	×	×	○ ^{*29}	×	×	×	
		LJ72GF15-T2	×	×	×	○	○	×	×	○	×	×	×	
CC-Link IE Field Network Ethernet adapter module	MELSEC-L Series	NZ22GF-ETB ^{*24}	○	○	×	×	×	×	×	×	×	×	×	

- ¹ Includes the connection where MELSECNET/H is used in the MELSECNET/10 mode. Connection to the remote I/O network is not allowed.
- ² Use a CC-Link IE Controller Network module with the upper five digits of the serial No. later than 09042.
- ³ Use a CPU and a CC-Link IE Controller Network module with the upper five digits of the serial No. later than 09042.
- ⁴ Use a CPU with the upper five digits of the serial No. later than 12012.
- ⁵ Use a CPU of function version B or later or a CC-Link IE Controller Network module of function version D or later.
- ⁶ For the multiple CPU system configuration, use a CPU of function version B or later.
- ⁷ Use a CPU with the upper five digits of the serial No. later than 09012.
When the total number of stations in a network is 65 or more, use a CC-Link IE Controller Network module with the upper five digits of the serial No. 09042 or later.
- ⁸ When the total number of stations in a network is 65 or more, use a CC-Link IE Controller Network module with the upper five digits of the serial No. 09042 or later.
- ⁹ Use a CPU with the upper five digits of the serial No. later than 10042 or a CC-Link IE Controller Network module of function version D or later.
- ¹⁰ Use a MELSECNET/H interface board driver (SW0DNC-MNETH-B) with the version K or later.
- ¹¹ Only the host station and the host station settings can be accessed. (Access to other stations or other PLC CPUs are not allowed.)
- ¹² Use a CPU with the upper five digits of the serial No. later than 10032 or a CC-Link IE Controller Network module of function version D or later.
- ¹³ Use a CPU with the upper five digits of the serial No. later than 13042.
- ¹⁴ When using a LJ71E71-100, use a CPU with the upper five digits of the serial No. later than 14112.
- ¹⁵ Use a LJ71E71-100 since L02SCPU and L02SCPU-P have no built-in Ethernet port.
- ¹⁶ Use a CPU with the upper five digits of the serial No. later than 13012.
- ¹⁷ The adapter L6ADP-R2 is required.
- ¹⁸ Access via the serial port (RS-232) of QCPU in the multiple CPU system since the CPU has no serial port.
- ¹⁹ Use the serial port of a serial communication module controlled by another CPU on the multiple CPU system.
- ²⁰ Use a CPU with the upper five digits of the serial No. later than 12042.

- ²¹ When using SV43, use the Motion CPU on which any of the following main OS software version is installed.
SW7DNC-SV43□□: 00F or later
- ²² Only the PLC CPU area (CPU No.1) can be connected. The PERIPHERAL I/F cannot be used.
- ²³ In the Ethernet, MELSECNET/H, or MELSECNET/10 connection, to monitor a QCPU in the multiple CPU system, always use a network module of function version B or later.
- ²⁴ Devices of other stations can be monitored via NZ22GF-ETB. (Devices of the host station cannot be monitored.)
- ²⁵ Use the built-in Ethernet port since RJ71EN71 is not supported.
- ²⁶ Access via the RCP in the multiple CPU system since the CPU has no USB port to connect to a personal computer.
- ²⁷ Mount a safety function module R6SFM next to the RnSFPCU on the base unit. The RnSFPCU and the safety function module R6SFM must have the same pair version. If their pair versions differ, the RnSFPCU does not operate.
- ²⁸ Mount a redundant function module R6RFM next to the RnPCPU on the base unit when building a redundant system.
- ²⁹ In a redundant system, use a CC-Link IE Field Network interface board with the upper five digits of the serial No. 18042 or later.
- ³⁰ Mount the SIL2 function module R6PSFM and redundant function module R6RFM next to the RnPSFPCU on the base unit.
- ³¹ The supported version of the main units varies depending on the Ethernet module to be used.

Ethernet module*	CPU		
	FX3U(C)	FX3G(C)	FX3S
FX3U-ENET-L	Ver. 2.21 or later	FX3U-ENET-L is not supported.	
FX3U-ENET-ADP*	Ver. 3.10 or later	Ver. 2.00 or later	Ver. 1.00 or later

- *To connect to FX3SCPU, use FX3U-ENET-ADP Ver.1.20 or later.
- ³² PERIPHERAL I/F can be used.
- ³³ Use the built-in Ethernet port since LJ71EN71 is not supported.

■ Modules usable when connected with Mitsubishi Electric programmable controllers/C Controller modules/
Motion controllers

● Ethernet connection

• Programmable controller Ethernet modules

CPU series	Ethernet module
MELSEC iQ-R Series	RJ71EN71 ^{*4} RJ71GN11-T2 ^{*6 *7} RD78G4 ^{*6 *7 *8} NEW RD78G8 ^{*6 *7 *8} NEW RD78G16 ^{*6 *7 *8} NEW RD78G32 ^{*6 *7 *8} NEW RD78G64 ^{*6 *7 *8} NEW RD78GHV ^{*6 *7 *8} NEW RD78GHW ^{*6 *7 *8} NEW
C Controller module (MELSEC iQ-R Series) ^{*6 *9}	RJ71GN11-T2 RD78G4 ^{*8} RD78G8 ^{*8} RD78G16 ^{*8} RD78G32 ^{*8} RD78G64 ^{*8} RD78GHV ^{*8} RD78GHW ^{*8}
MELSECWinCPU (MELSEC iQ-R Series) NEW	RJ71GN11-T2
MELSEC iQ-F Series NEW	FX5-ENET ^{*11} FX5-ENET/IP ^{*11} FX5-CCLGN-MS ^{*6 *10} FX5-40SSC-G ^{*6 *10 *12} FX5-80SSC-G ^{*6 *10 *12}
Motion controller (MELSEC iQ-R Series) CC-Link IE Field Network head module (MELSEC iQ-R Series)	RJ71EN71 ^{*4}
MELSEC-Q Series (Q mode) MELSEC-QS Series C Controller module (MELSEC-Q Series) Motion controller (MELSEC-Q Series) ^{*11}	QJ71E71-100 QJ71E71-B5 QJ71E71-B2 QJ71E71
MELSEC-L Series	LJ71E71-100 ^{*2}
MELSEC-F Series	FX3U-ENET-L ^{*3} FX3U-ENET-ADP ^{*3 *5}

*1 When connecting to a Q170MCPUCPU/Q170MSSCPU(-S1), only the PLC CPU area (CPU No.1) can be monitored. The PERIPHERAL I/F cannot be used.
 *2 When using a LJ71E71-100, use a CPU with the upper five digits of the serial No. later than 141112.
 *3 Options for extension controller may be required depending on the connected CPU.
 *4 Use firmware version 12 or higher when building a redundant system.
 *5 Use FX3U-ENET-ADP Ver.1.20 or higher to connect to FX3SCPU.
 *6 Only available to GT SoftGOT2000 (Multi-channel).
 *7 For connectable programmable controller CPUs and their firmware versions that support connection to each module, please refer to the manual of the CPU or the module to use.
 *8 Use the basic system software version 06 or higher when using motion modules.
 *9 When connecting to the CC-Link IE TSN master/local module or Motion module, use the C Controller module (MELSEC iQ-R series) with firmware version 15 or later.
 *10 FX5UJ is not supported.
 *11 Use firmware version 1.100 or later for the FX5-ENET and FX5-ENET/IP.
 For FX5U, FX5UC, and FX5UJ that support FX5-ENET or FX5-ENET/IP, use firmware Ver.1.240 or later.
 *12 For FX5U and FX5UC that support FX5-40SSC-G or FX5-80SSC-G, use firmware Ver.1.230 or later.

● Serial communication connection^{*1}

• Programmable controller serial communication modules

CPU series	Serial communication module
MELSEC iQ-R Series C Controller module (MELSEC iQ-R Series) ^{*4} Motion controller (MELSEC iQ-R Series) CC-Link IE Field Network head module (MELSEC iQ-R Series)	RJ71C24 ^{*3} RJ71C24-R2 ^{*3}
MELSEC-Q Series (Q mode) C Controller module (MELSEC-Q Series) Motion controller (MELSEC-Q Series) ^{*2}	QJ71C24 QJ71C24-R2 QJ71C24N QJ71C24N-R2 QJ71CMO QJ71CMON
MELSEC-L Series CC-Link IE Field Network head module (MELSEC-L Series)	LJ71C24 LJ71C24-R2

*1 Only RS-232C communication can be used.
 *2 When connecting to a Q170MCPUCPU/Q170MSSCPU(-S1), only the PLC CPU area (CPU No.1) can be monitored.
 *3 Use firmware version 07 or higher when building a redundant system.
 *4 Use the serial port of a serial communication module controlled by another CPU on the multiple CPU.

● CC-Link IE TSN connection

CPU Series	CC-Link IE TSN module
MELSEC iQ-R Series	×
MELSEC iQ-F Series NEW	×

● CC-Link IE Controller Network connection

• Network modules (programmable controller side)

CPU series	CC-Link IE Controller Network module
MELSEC iQ-R Series C Controller module (MELSEC iQ-R Series) Motion controller (MELSEC iQ-R Series)	RJ71GP21-SX ^{*2}
MELSEC-Q Series (Q mode) MELSEC-QS Series C Controller module (MELSEC-Q Series) Motion controller (MELSEC-Q Series) ^{*1}	QJ71GP21-SX QJ71GP21S-SX

*1 When connecting to a Q170MCPUCPU/Q170MSSCPU(-S1), only the PLC CPU area (CPU No.1) can be monitored.
 *2 Use firmware version 12 or higher when building a redundant system.

• Network interface boards (personal computer side)

Type	Network interface board
CC-Link IE Controller Network	Q80BD-J71GP21-SX Q80BD-J71GP21S-SX Q81BD-J71GP21-SX (optical loop) Q81BD-J71GP21S-SX (optical loop, with external power supply function)

Specifications

- There are two ways of usage of GT SoftGOT2000: GT SoftGOT2000 for single channel connection and GT SoftGOT2000 (Multi-channel) for multi-channel connection. GT SoftGOT2000 (Multi-channel) supports Ethernet connection, connection to OPC UA servers, or connection to microcomputers. Therefore in the following list, Ethernet connection column is separated in two columns: Single (GT SoftGOT2000) and Multi (GT SoftGOT2000 (Multi-channel)). For connection with OPC UA servers or microcomputers, please refer to page 194.
- For the details of the connection configuration, please refer to the GT SoftGOT2000 Version1 Operating Manual.

● CC-Link IE Field Network connection

• Network modules (programmable controller side)

CPU series	CC-Link IE Field Network module
MELSEC iQ-R Series C Controller module (MELSEC iQ-R Series) Motion controller (MELSEC iQ-R Series)	RJ71GF11-T2 *2 RJ71EN71 RD77GF4 RD77GF8 RD77GF16 RD77GF32
MELSEC-Q Series (Q mode) C Controller module (MELSEC-Q Series) Motion controller (MELSEC-Q Series) *1	QJ71GF11-T2
MELSEC-QS Series	QS0J71GF11-T2
MELSEC-L Series	LJ71GF11-T2
MELSEC iQ-F Series	×

*1 When connecting to a Q170MCP/Q170MSCPU(-S1), only the PLC CPU area (CPU No.1) can be monitored.
*2 Use firmware version 12 or higher when building a redundant system.

• Network interface boards (personal computer side)

Type	Network interface board
CC-Link IE Field Network	Q81BD-J71GF11-T2

● MELSECNET/H, MELSECNET/10 connection

• Network modules (programmable controller side)

CPU series	MELSECNET/H, MELSECNET/10 network module	
	Optical loop	Coaxial bus
MELSEC-Q Series (Q mode) *1 MELSEC-QS Series Motion controller (MELSEC-Q Series) *2	QJ71LP21 QJ71LP21-25 QJ71LP21S-25	QJ71BR11 *1
C Controller module (MELSEC-Q Series)	QJ71LP21-25 QJ71LP21S-25	

*1 Use function version B or later of the MELSECNET/H network module and CPU.
*2 When connecting to a Q170MCP/Q170MSCPU(-S1), only the PLC CPU area (CPU No.1) can be monitored.

• Network interface boards (personal computer side)

Type	Network interface board
MELSECNET/H	Q80BD-J71LP21-25 (optical loop) Q80BD-J71LP21S-25 (optical loop, with external power supply function) Q80BD-J71LP21G (optical loop) Q80BD-J71BR11 (coaxial loop) Q81BD-J71LP21-25 (optical loop)

◆ Mitsubishi Electric industrial computer

Series	Model name	Connection type										
		Ethernet connection		Direct CPU connection (RS-232)	Direct CPU connection (USB)	Serial communication connection	CC-Link IE TSN connection	CC-Link IE Controller Network connection	CC-Link IE Field Network connection	MELSEC NET/H connection	MELSEC NET/10 connection *1	MELIPC direct connection
		Single	Multi									
MELIPC	MI5122-VW	○	○	×	×	×	×	×	○	×	×	○

*1 Only supports the case where MELSECNET/H is used in the MELSECNET/10 mode. Connection to the remote I/O network is not allowed.

◆ Mitsubishi Electric inverters

Series	Model name	Connection type					
		Ethernet connection		RS-485	RS-232	Multi-drop connection	
		Single	Multi				
FR-A800 Series	FR-A8□0 *1 *4		○ *3				
	FR-A8□2 *1 *4						
	FR-A8□6 *1 *4						
	FR-A8□0-E *2		○				
	FR-A8□2-E *2						
	FR-A8□6-E *2						
	FR-A8□0-GF *1		○ *3				
	FR-A8□2-GF *1						
	FR-A8□0-GN *4 NEW		○				
	FR-A8□2-GN *4 NEW						
FR-A800 Plus Series	FR-A8□0-CRN *1		○				
	FR-A8□2-CRN *1						
	FR-A8□0-E-CRN *2		○ *3				
	FR-A8□2-E-CRN *2						
	FR-A8□0-R2R *1		○				
	FR-A8□2-R2R *1	x		x	x	x	
	FR-A8□0-E-R2R *2		○ *3				
	FR-A8□2-E-R2R *2						
	FR-A8□0-AWH *1 NEW		○				
	FR-A8□0-E-AWH NEW		○ *3				
	FR-A8□0-E-LC *1 NEW		○				
	FR-A8□0-E-LC *1 NEW						
	FR-F800 Series	FR-F8□0 *1 *4		○ *3			
		FR-F8□2 *1 *4					
FR-F8□6 *1 *4							
FR-F8□0-E *2 *4			○				
FR-E700 Series	FR-E7□0-NE *2		○				
	FR-E800 *1		○ *3				
FR-E800 Series NEW	FR-E8□0-E *1 *2		○				

*1 Inverter connection is supported by using CC-Link IE Field Network connection via a programmable controller CPU.

*2 Inverter connection is supported by using Ethernet connection via a programmable controller CPU.

*3 Connection is supported by using RJ71GN11-T2 via Ethernet.

*4 CC-Link IE TSN connection to inverters is supported via a programmable controller CPU.

◆ Mitsubishi Electric servo amplifiers (general-purpose) **NEW**

Series	Model name	Connection type				
		Ethernet connection		RS-422	RS-232	Multi-drop connection
		Single	Multi			
MELSERVO-J5 Series	MR-J5-□G					
	MR-J5-□G-RJ					
	MR-J5W2-□G	x	○	x	x	x
	MR-J5W3-□G					
	MR-J5D1-□G4					
	MR-J5D2-□G4					
MELSERVO-JET Series	MR-JET-□G	x	○	x	x	x

◆ Mitsubishi Electric servo amplifiers (SSCNET III/H)

Series	Model name	Motion controller or programmable controller	Connection type												
			Ethernet connection		Direct CPU connection (RS-232)	Direct CPU connection (USB)	Serial communication connection	CC-Link IE TSN connection	CC-Link IE Controller Network connection	CC-Link IE Field Network connection	MELSEC NET/H connection	MELSEC NET/10 connection *1			
			Simple motion module	CPU type									Single	Multi	
MELSERVO-J4 Series	MR-J4-□B MR-J4-□B-RJ MR-J4W2-□B MR-J4W3-□B	-	RnMTCPU	○	○	x	○	○	x	○	○	x	x		
			Q17nDSCPU	x	○	○	○	○	x	○	○	○	○		
			Q170MSCPU	x	○	○	○	○	x	○	○	○	○		
		RD77MS	RnCPU	○	○	x	○	○	x	○	○	x	x		
		QD77MS *3	QnCPU	x	○	○	○	○	x	○	○	○	○		
		LD77MS	LrCPU	x	○	○	○	○	x	x	○	x	x		
		FX5-40SSC-S	FX5CPU	○	○	x	x	x	x	x	x	x	x		
		FX5-80SSC-S	FX5CPU	○	○	x	x	x	x	x	x	x	x		
		MELSERVO-JE Series	MR-JE-□B	RD77MS *2	RnCPU	○	○	x	○	○	x	○	○	x	x
				QD77MS *4	QnCPU	x	○	○	○	○	x	○	○	○	○
LD77MS *4	LrCPU			x	○	○	○	○	x	x	○	x	x		
FX5-40SSC-S	FX5CPU			○	○	x	x	x	x	x	x	x	x		
FX5-80SSC-S	FX5CPU			○	○	x	x	x	x	x	x	x	x		

*1 Only supports the case where MELSECNET/H is used in the MELSECNET/10 mode. Connection to the remote I/O network is not allowed.

*2 Use a module with the firmware version 3 or later.

*3 Use a module with the upper five digits of the serial No. later than 15041.

*4 Use a module with the upper five digits of the serial No. later than 16102.

Specifications

- There are two ways of usage of GT SoftGOT2000: GT SoftGOT2000 for single channel connection and GT SoftGOT2000 (Multi-channel) for multi-channel connection. GT SoftGOT2000 (Multi-channel) supports Ethernet connection, connection to OPC UA servers, or connection to microcomputers. Therefore in the following list, Ethernet connection column is separated in two columns: Single (GT SoftGOT2000) and Multi (GT SoftGOT2000 (Multi-channel)). For connection with OPC UA servers or microcomputers, please refer to page 194.
- For the details of the connection configuration, please refer to the GT SoftGOT2000 Version1 Operating Manual.

◆ Mitsubishi Electric servo amplifiers (CC-Link IE Field Network) NEW

Series	Model name	Motion controller or programmable controller		Connection type										
				Ethernet connection		Direct CPU connection (RS-232)	Direct CPU connection (USB)	Serial communication connection	CC-Link IE TSN connection	CC-Link IE Controller Network connection	CC-Link IE Field Network connection	MELSEC NET/H connection	MELSEC NET/10 connection	
				Single	Multi									
MELSERVO-J4 Series	MR-J4-CIGF MR-J4-CIGF-RJ	RD77GF4 *1	RnCPU	X	○	X	X	X	X	X	X	X	X	X
		RD77GF8 *1	RnCPU	X	○	X	X	X	X	X	X	X	X	X
		RD77GF16 *1	RnCPU	X	○	X	X	X	X	X	X	X	X	X
		RD77GF32	RnCPU	X	○	X	X	X	X	X	X	X	X	X
		QD77GF4 *2	QnCPU	X	○	X	X	X	X	X	X	X	X	X
		QD77GF8 *2	QnCPU	X	○	X	X	X	X	X	X	X	X	X
		QD77GF16 *2	QnCPU	X	○	X	X	X	X	X	X	X	X	X
		RnENCPU	RnCPU	X	○	X	X	X	X	X	X	X	X	X
		RJ71EN71	RnCPU	X	○	X	X	X	X	X	X	X	X	X
		RJ71GF11-T2	RnCPU	X	○	X	X	X	X	X	X	X	X	X
		QJ71GF11-T2 *3	QnCPU	X	○	X	X	X	X	X	X	X	X	X
		LJ71GF11-T2 *3	LnCPU	X	○	X	X	X	X	X	X	X	X	X

*1 To use the motion mode, use a module with the firmware version 1 or later; to use the I/O mode, use a module with the firmware version 2 or later.

*2 To use the I/O mode, use a module with the upper five digits of the serial No. later than 18022.

*3 Use a module with the upper five digits of the serial No. later than 14102. Motion mode is not supported.

◆ Mitsubishi Electric servo amplifiers (CC-Link IE TSN) NEW

Series	Model name	Programmable controller		Connection type										
				Ethernet connection *1		Direct CPU connection (RS-232)	Direct CPU connection (USB)	Serial communication connection	CC-Link IE TSN connection	CC-Link IE Controller Network connection	CC-Link IE Field Network connection	MELSEC NET/H connection	MELSEC NET/10 connection	
				Motion module *2	CPU type									Single
MELSERVO-J5 Series	MR-J5-CIG MR-J5-CIG-RJ MR-J5W2-CIG MR-J5W3-CIG MR-J5D1-CIG4 MR-J5D2-CIG4 MR-J5D3-CIG4	RD78G4	RnCPU	X	○	X	X	X	X	X	X	X	X	X
		RD78G8		X	○	X	X	X	X	X	X	X	X	
		RD78G16		X	○	X	X	X	X	X	X	X	X	
		RD78G32		X	○	X	X	X	X	X	X	X	X	
		RD78G64	R12CCPU-V	X	○	X	X	X	X	X	X	X	X	X
		RD78GHV		X	○	X	X	X	X	X	X	X	X	
		RD78GHW		X	○	X	X	X	X	X	X	X	X	
		FX5-40SSC-G	FX5U FX5UC	X	○	X	X	X	X	X	X	X	X	X
		FX5-80SSC-G		X	○	X	X	X	X	X	X	X	X	
		MELSERVO-JET Series	MR-JET-G	RD78G4	RnCPU	X	○	X	X	X	X	X	X	X
RD78G8	X			○		X	X	X	X	X	X	X		
RD78G16	X			○		X	X	X	X	X	X	X		
RD78G32	X			○		X	X	X	X	X	X	X		
RD78G64	R12CCPU-V			X	○	X	X	X	X	X	X	X	X	
RD78GHV				X	○	X	X	X	X	X	X	X		
RD78GHW				X	○	X	X	X	X	X	X	X		
FX5-40SSC-G	FX5U FX5UC			X	○	X	X	X	X	X	X	X	X	
FX5-80SSC-G				X	○	X	X	X	X	X	X	X		

*1 Connect a servo amplifier to the built-in Ethernet port of a programmable controller CPU directly or via a hub.

*2 When monitoring a servo amplifier through a Motion module, the available mode on the servo amplifier varies depending on the firmware version of the Motion module to use. For the details, please refer to the manual of the Motion module to use.

◆ Mitsubishi Electric robot controllers

Series	Controller name	Connection type									
		Ethernet connection		Direct CPU connection (RS-232)	Direct CPU connection (USB)	Serial communication connection	CC-Link IE TSN connection	CC-Link IE Controller Network connection	CC-Link IE Field Network connection	MELSEC NET/H connection	MELSEC NET/10 connection *1
		Single	Multi								
F Series	CR750-Q(Q172DRCPU)	○ *2	○ *2	○ *3	○ *5	○	X	○ *4	○	○	○
	CR750-D CR751-D	○	○	X	X	X	X	X	X	X	X
SQ Series	CRnQ-700(Q172DRCPU)	○ *2	○ *2	○ *3	○ *5	○	X	○ *4	○	○	○
SD Series	CRnD-700	○	○	X	X	X	X	X	X	X	X
FR Series	CR800-D	○	○ *7	X	X	X	X	X	X	X	X
	CR800-R(R16RTCPU)	○	○	X	○ *6	X	X	X	X	X	X
	CR800-Q(Q172DSRCPU)	○	○	○ *3	○ *5	○	X	○ *4	○	○	○

*1 Only supports the case where MELSECNET/H is used in the MELSECNET/10 mode. Connection to the remote I/O network is not allowed.

*2 The Display I/F of CRnQ-700, CR750/751-Q cannot be used. Ethernet connections can be established only via the Ethernet module (QJ71E71) or the built-in Ethernet port in the multiple CPU system (QnUDE).

*3 Access via the serial port (RS-232) of QCPU in the multiple CPU system since CRnQ-700, CR750/751-Q, and CR800-Q have no serial port.

*4 Use a CC-Link IE Controller Network module with the upper five digits of the serial No. later than 09042.

*5 Access via QCPU in the multiple CPU system since CR750-Q, CR751-Q, CRnQ-700, and CR800-Q have no USB port.

*6 Access via RCPU in the multiple CPU system since CR800-R has no USB port.

*7 Connectable to the built-in LAN port of CR800-D in Ethernet connection.

◆ Mitsubishi Electric CNCs

Series	Connection type									
	Ethernet connection		Direct CPU connection (RS-232)	Direct CPU connection (USB)	Serial communication connection	CC-Link IE TSN connection	CC-Link IE Controller Network connection	CC-Link IE Field Network connection	MELSEC NET/H connection	MELSEC NET/10 connection *1
	Single	Multi								
CNC C80 (R16NCCPU-S1)	○	○	X	○ *4	X	X	X	X	X	X
CNC C70 (Q173NCCPU)	○	○	○ *2	○	○	X	○ *3	○	○	○

*1 Only supports the case where MELSECNET/H is used in the MELSECNET/10 mode. Connection to the remote I/O network is not allowed.

*2 Access via the serial port (RS-232) of QCPU in the multiple CPU system since CNC C70 has no serial port.

*3 Use a CC-Link IE Controller Network module with the upper five digits of the serial No. later than 09042.

*4 Access via RCPU in the multiple CPU system since CNC C80 has no USB port.

◆ Non-Mitsubishi programmable controllers/Motion controllers

Manufacturer		Model name		Connection type			
				Ethernet connection		Direct CPU connection (RS-232)	Serial communication connection (RS-232)
				Single	Multi		
OMRON Corporation	SYSMAC CJ1	CJ1H	CJ1M	○	○	○	×
		CJ1G		○	○	○	×
	SYSMAC CJ2	CJ2H	CJ2M	○	○	○ ^{*1}	×
		CJ2M		○	○	○ ^{*1}	×
	SYSMAC CPM	CPM2A		×	×	○	×
	SYSMAC CQM1	CQM1		×	×	○ ^{*2}	×
	SYSMAC CQM1H	CQM1H		×	×	○	×
	SYSMAC CP1	CP1E (N type)		×	×	○ ^{*6}	×
	SYSMAC CP2 NEW	CP2E-E		×	×	○	×
		CP2E-S		×	×	○	×
		CP2E-N		○	○	○	×
	SYSMAC CS1	CS1H	CS1D ^{*3}	○	○	○	×
		CS1G		○	○	○	×
	SYSMAC CVM1/CV ^{*4}	CVM1-CPU11-V□	CV1000-CPU01-V□	×	×	○	×
CVM1-CPU01-V□		CV2000-CPU01-V□					
CV500-CPU01-V□							
SYSMAC α	C200HX	C200HE	×	×	○	×	
	C200HG						
NJ	NJ501-□□□□	NJ301-□□□□	×	×	×	×	
	NJ101-□□□□						
KEYENCE CORPORATION		KV-700	KV-3000	○	○	×	×
		KV-1000		○	○	×	×
		KV-5000		○	○	×	×
		KV-7300		○	○	×	×
		KV-7500		○	○	×	×
		KV-8000 NEW		○	○	×	×
TOSHIBA CORPORATION	Unified Controller nv Series	PU811		○	○	×	×
		PUM11		○	○	×	×
		PUM12		○	○	×	×
		PUM14		○	○	×	×
				○	○	×	×
Hitachi Industrial Equipment Systems Co., Ltd.	NEW	EHV series		○	○	×	×
		MICRO-EHV series		○	○	×	×
YASKAWA Electric Corporation		GL120	GL130	×	×	○	×
		GL60S	GL70H	×	×	×	○
		GL60H		×	×	×	○
		CP-9200SH		×	×	×	○
		CP-9300MS		×	×	○	×
		MP920		○	○	○	○
		MP930		×	×	○	×
		MP940		×	×	○	×
		PROGIC-8		×	×	○	×
		CP-9200 (H)		×	×	○	×
		CP-312		×	×	×	×
		CP-317		○	○	×	○
		MP2200	MP2300S	○	○	×	○
		MP2300		○	○	×	○
		MP3200	MP3300	○	○	×	×
		Yokogawa Electric Corporation	FA-M3	F3SP05	F3SP38	○	○
F3SP08	F3SP53						
F3FP36	F3SP58						
F3SP21	F3SP59						
F3SP25	F3SP66						
F3SP28	F3SP67						
F3SP35							
FA-M3V	F3SP71-4N		F3SP76-7S	○	○	×	×
	F3SP71-4S			○	○	×	×
STARDOM	NFCP100	NFJT100	○ ^{*7}	○ ^{*7}	×	×	
LS Industrial Systems Co., Ltd. NEW	XGT	XGK-CPUU	XGK-CPUH	○	○	×	×
		XGK-CPUH	XGK-CPUUN				
		XGK-CPUA	XGK-CPUHN				
		XGK-CPUS	XGK-CPUSN				
Siemens AG		SIMATIC S7-200 series ^{*5}	SIMATIC S7-400 series	○	○	×	×
		SIMATIC S7-200 SMART series NEW	SIMATIC S7-1200 series ^{*5}				
		SIMATIC S7-300 series	SIMATIC S7-1500 series ^{*5}				
			NEW				

*1 Only CJ2M-CPU1□ can be connected.

*2 Connection to the CQM1-CPU11 is not allowed since the CQM1-CPU11 has no RS-232 interface.

*3 Connection is supported only when a single communication unit is used in a single CPU system configuration.

*4 SYSMAC CVM1/CV can be used with a CPU version 1 or later.

*5 Only OP communication can be used in Ethernet connection of the S7-200 series, the S7-1200 series, and the S7-1500 series.

*6 Connection is not available with the E type CP1E.

*7 Only MODBUS®/TCP connection is supported. Use the MODBUS®/TCP master communication driver.

Specifications

- There are two ways of usage of GT SoftGOT2000: GT SoftGOT2000 for single channel connection and GT SoftGOT2000 (Multi-channel) for multi-channel connection. GT SoftGOT2000 (Multi-channel) supports Ethernet connection, connection to OPC UA servers, or connection to microcomputers. Therefore in the following list, Ethernet connection column is separated in two columns: Single (GT SoftGOT2000) and Multi (GT SoftGOT2000 (Multi-channel)). For connection with OPC UA servers or microcomputers, please refer to page 194.
- For the details of the connection configuration, please refer to the GT SoftGOT2000 Version1 Operating Manual.

■ Modules usable when connected with non-Mitsubishi controllers in serial communication connection or Ethernet connection

Manufacturer		Ethernet		RS-232	
OMRON Corporation	Ethernet module	CS1W-ETN21 CS1W-EIP21 CJ1W-EIP21 NEW	CJ1W-ETN21 CS1D-ETN21D	—	
KEYENCE CORPORATION	Ethernet module	KV-LE20V KV-EP21V	KV-LE21V	—	
TOSHIBA CORPORATION	Ethernet module	EN811		—	
Hitachi Industrial Equipment Systems Co., Ltd. NEW	Intelligent serial port module Network module	EH-ETH/ETH2 EH-ELK	EH-ORML EH-R2LH/OR2LH	—	
YASKAWA Electric Corporation	MEMOBUS module Communication module	218IF 218IF-01 218IF-02 *1 218TXB		JAMSC-IF60 JAMSC-IF61 CP-217IF 217IF	217IF-01 218IF-01 218IF-02 *1
Yokogawa Electric Corporation	Ethernet interface module	F3LE01-5T F3LE11-0T F3LE12-0T		—	
Siemens AG	Ethernet module	CP243-1 CP243-1 IT CP343-1 CP343-1 Advanced	CP343-1 IT CP343-1 Lean CP443-1 CP443-1 IT	—	
LS Industrial Systems Co., Ltd. NEW	Ethernet module	XGL-EFMT(B)		—	

*1 To connect MP2200, MP2300, or MP2300S using Ethernet connection or RS-232 connection, use a CPU of software version 2.60 or later.

◆ Non-Mitsubishi robot controllers **NEW**

Manufacturer	Model name	Connection type				
		Ethernet connection		Direct CPU connection (RS-232)	Serial communication connection (RS-232)	
		Single	Multi			
YASKAWA Electric Corporation	Robot controller	YRC1000	○	○	×	×

◆ MODBUS® devices

Communication is possible with devices compatible with MODBUS®/TCP master or MODBUS®/TCP slave connection. For the MODBUS® devices, which have been checked for operation, please refer to the Technical Bulletin "List of Valid Devices Applicable for GOT2000 Series MODBUS® Connection" (No. GOT-A-0070) on the Mitsubishi Electric Factory Automation Global website.

◆ SLMP devices

Communication with SLMP compatible devices is possible. For the SLMP devices, which have been checked for operation, please refer to the Technical Bulletin "List of SLMP-compatible Equipment Validated to Operate with the GOT2000 Series" (No. GOT-A-0085) on the Mitsubishi Electric Factory Automation Global website.

◆ OPC UA servers

Communication with OPC UA servers is possible. For the OPC UA servers, which have been checked for operation, please refer to the Technical Bulletin "List of OPC UA Servers Validated to Operate with the GOT2000 Series" (No. GOT-A-0137) on the Mitsubishi Electric Factory Automation Global website.

◆ Microcomputer connection

By connecting a personal computer, microcomputer board, programmable controller, etc. to a GOT, the data can be written to or read from virtual devices of the GOT.

Compatibility with conventional products

◆ Compatibility with GOT1000 Series

- The following shows the overview of replacing from the GOT1000 Series. For the details, please refer to the following Technical Bulletins.
- Technical Bulletin “Precautions when Replacing GOT1000 Series with GOT2000 Series” No.GOT-A-0061 (GT16, GT15)
 - Technical Bulletin “Precautions when Replacing the GT14 Model with GT2505(HS)-VTBD” No.GOT-A-0125 (GT14)
 - Technical Bulletin “Precautions when Replacing GT11 Model with GT27 and GT25 Models” No.GOT-A-0145 (GT11)
 - Technical Bulletin “Information and precautions on replacing GOT1000 with GOT2000 (GT10 model → GT21 model)” No.HIME-T-P-0137

Panel cut dimensions

The panel cut dimensions are the same if the GOT1000 Series and the GOT2000 Series have the same screen size. Changing mounting holes is not required.

GOT1000 Series		GOT2000 Series
15"	GT1695 *1, GT1595 *1	Same dimensions as GT2715.
12.1"	GT1685 *1, GT1585 *1	Same dimensions as GT2712, GT2512.
10.4"	GT167□ *1, GT157□ *1, GT1275 *1	Same dimensions as GT2710, GT2510-V, GT2310.
8.4"	GT166□ *1, GT156□ *1, GT1265 *1	Same dimensions as GT2708, GT2508, GT2308.
5.7"	GT1655 *1, GT155□ *1, GT145□ *1, GT115□ *1, GT105□ *1	Same dimensions as GT2705, GT2505.
3.7"	GT1020 *1	Same dimensions as GT2103. (Although the screen size differs, panel cut dimensions are the same.)

*1 Discontinued product.

Communication units, option units

Communication units and option units for the GT16, GT15, GT12, or GT10 can be used with the GOT2000 Series as-is except for the following devices.

GOT1000 Series		GOT2000 Series	Remarks
Communication unit	RS-422 conversion unit	GT15-RS2T4-9P *1 GT15-RS2T4-25P *1	Use the built-in RS-422/485 interface or GT15-RS4-9S (serial communication unit)
	MELSECNET/10 communication unit	GT15-J71LP23-Z *1 GT15-J71BR13-Z *1	GT15-J71LP23-25 (MELSECNET/H communication unit) GT15-J71BR13 (MELSECNET/H communication unit)
	CC-Link communication unit (CC-Link (ID) Ver.1)	GT15-J61BT13-Z *1	GT15-J61BT13 (CC-Link communication unit)
	Connection conversion adapter	GT10-9PT5S	—
	Ethernet communication unit	GT15-J71E71-100 *1	Use the built-in Ethernet interface or GT25-J71E71-100 (Ethernet communication unit)
Option unit	Multimedia unit	GT16M-MMR *1	GT27-MMR-Z (multimedia unit) A CF card is used with the unit.
	Video input unit	GT16M-V4 *1	GT27-V4-Z (video input unit)
		GT15V-75V4 *1	
	RGB input unit	GT16M-R2 *1	GT27-R2 (RGB input unit)
		GT15V-75R1 *1	
	Video/RGB input unit	GT16M-V4R1 *1	GT27-V4R1-Z (video/RGB input unit)
		GT15V-75V4R1 *1	
	RGB output unit	GT16M-ROUT *1	GT27-ROUT (RGB output unit)
GT15V-75ROUT *1			
CF card unit	GT15-CFCD *1	—	
CF card extension unit	GT15-CFEX-C08SET *1	—	

*1 Discontinued product.

Cables

<GT16, GT15>

- For the details of using the bus connection cables, RS-232 cables, RS-422 cables, or other cables for GT16 or GT15 with GT27 or GT25, please refer to the Technical Bulletin “Precautions when Replacing GOT1000 Series with GOT2000 Series” No. GOT-A-0061.

<GT14>

- RS-232, RS-422, and other cables being used with GT14 can be used as-is with GT2505-VTBD or GT2505HS-VTBD.

<GT10>

- The cables being used with GT1020 can be used as-is with GT2103 (serial type).

Project data

The project data of the GOT1000 Series can be used as-is by converting the GOT Type using GT Designer3 Version 1.100E or later *.

* The supported version differs depending on the GOT2000 models.

◆ Compatibility with GOT900 Series

For the details, please refer to the following Technical Bulletins.

- Technical Bulletin “Precautions when Replacing GOT-A900 Series with GOT2000 Series” No.GOT-A-0062

◆ Compatibility with GOT800, A77GOT, or A64GOT Series

For the details, please refer to the following Technical Bulletins.

- Technical Bulletin “Precautions when Replacing A800, A77GOT, A64GOT Series with GOT2000 Series” No.GOT-A-0063

For the Technical Bulletins, please refer to the Mitsubishi Electric Factory Automation Global website (www.MitsubishiElectric.com/fa/).

Product List

GOT model name

For the status of conforming to various standards and laws (CE, UKCA, ATEX, UL/cUL, Class I Division 2, KC, KCs, and maritime certifications [ABS/BV/DNV/LR/NK/RINA]), please contact your local sales office.

GT27 15 - XTBA

Symbol	Screen size	Symbol	Structure	Symbol	Resolution	Symbol	Display section	Symbol	Panel color	Symbol	Power type	Symbol	Communication interface
15	15"	None	Standard	WX	WXGA	T	TFT color	B	Black	A	100 V AC to 240 V AC	None *1	Refer to Remarks column of GOT
12	12.1" or 12.1" widescreen	F	Open frame	X	XGA	M	TFT monochrome	W	White	D	24 V DC		
10	10.4", 10.1" widescreen, or 10" widescreen	HS	Handy	S	SVGA			S	Silver	L	5 V DC	S *1	RS-232 and RS-422/485 interfaces, or RS-422 interface only
08	8.4"	T	Rugged	W	WVGA			N	No frame			S2 *1	Two RS-232 interfaces
07	7" widescreen			V	VGA							-GF *2	CC-Link IE Field Network communication unit set
06	6.5"			R	480 × 272 dots								
05	5.7"			P	320 × 128 dots								
04	4.3"												
03	3.8"												

*1 For GT21 only
*2 For GT27/GT25 only

GT27	Advanced model with multi-touch gesture functions
GT25	High-performance, cost efficient, mid-range model
GT23	Unchallenged cost performance
GT21	Compact models with basic functions
GS21	Simple model with pursued usability

GOTs

Classification	Model	Screen size	Display section Display color	Panel color	Power	Remarks		
GT27	GT2715-XTBA	15" XGA	TFT color 65536 colors	Black	100 to 240 V AC	Multimedia & Video/RGB compatible Multi-touch compatible		
	GT2715-XTBD				24 V DC			
	GT2712	GT2712-STBA		12.1" SVGA	Black		100 to 240 V AC	
		GT2712-STBD					24 V DC	
		GT2712-STWA			100 to 240 V AC			
		GT2712-STWD *1			24 V DC			
	GT2710	GT2710-STBA		10.4" SVGA	Black		100 to 240 V AC	
		GT2710-STBD					24 V DC	
		GT2710-VTBA		100 to 240 V AC				
		GT2710-VTBD		24 V DC				
GT2710-VTWA		100 to 240 V AC						
GT2710-VTWD *1		24 V DC						
GT2708	GT2708-STBA	8.4" SVGA	Black	100 to 240 V AC				
	GT2708-STBD			24 V DC				
	GT2708-VTBA	100 to 240 V AC						
	GT2708-VTBD	24 V DC						
GT2705	GT2705-VTBD	8.4" VGA	Black	100 to 240 V AC	24 V DC	Multi-touch compatible		
	GT2705-VTBD	5.7" VGA	Black	100 to 240 V AC	24 V DC			
GT25	GT2512-STBA	12.1" SVGA	TFT color 65536 colors	Black	100 to 240 V AC			
	GT2512-STBD				24 V DC			
	GT2512F-STNA			100 to 240 V AC				
	GT2512F-STND			24 V DC				
	GT2510	GT2510-VTBA		10.4" VGA	Black		100 to 240 V AC	
		GT2510-VTBD					24 V DC	
		GT2510-VTWA			100 to 240 V AC			
		GT2510-VTWD *1			24 V DC			
		GT2510F-VTNA			100 to 240 V AC			
		GT2510F-VTND			24 V DC			
	GT2508	GT2508-VTBA		8.4" VGA	Black		100 to 240 V AC	
		GT2508-VTBD					24 V DC	
		GT2508-VTWA			100 to 240 V AC			
		GT2508-VTWD *1			24 V DC			
GT2508F-VTNA		100 to 240 V AC						
GT2508F-VTND		24 V DC						
GT2505	GT2505-VTBD	5.7" VGA	Black	100 to 240 V AC	24 V DC			
GT25 Wide	GT2512-WXTBD	12.1" WXGA	TFT color 65536 colors	Black	24 V DC	Wide model		
	GT2512-WXTSD						Black	
	GT2510	GT2510-WXTBD		10.1" WXGA	Black		24 V DC	Silver *2
		GT2510-WXTSD						
	GT2507	GT2507-WTBD		7" WVGA	Black		24 V DC	Silver *2
		GT2507-WTSD						
GT25 Handy	GT2506	6.5" VGA	TFT color 65536 colors	Black	24 V DC	Handy GOT		
	GT2505	5.7" VGA	TFT color 65536 colors	Black	24 V DC			
GT25 Rugged	GT2507	7" WVGA	TFT color 65536 colors	Silver	24 V DC	Rugged model		
GT23	GT2310-VTBA	10.4" VGA	TFT color 65536 colors	Black	100 to 240 V AC			
	GT2310-VTBD				24 V DC			
	GT2308-VTBA	8.4" VGA		Black	100 to 240 V AC			
	GT2308-VTBD				24 V DC			

GOTs

Classification		Model	Screen size	Display section Display color	Panel color	Power	Remarks
GT21 Wide	GT2107	GT2107-WTBD	7" WVGA	TFT color 65536 colors	Black	24 V DC	Wide model
		GT2107-WTSD			Silver *2		
GT21	GT2104	GT2104-RTBD	4.3" [480 × 272 dots]	TFT color 65536 colors	Black	24 V DC	Ethernet, RS-422/485, RS-232
		GT2103-PMBD	3.8" [320 × 128 dots]	TFT Monochrome (black/white) 32 shade grayscale 5-color LED (white, green, pink, orange, red)	Black	24 V DC	Ethernet, RS-422/485
	GT2103-PMBDS	24 V DC				RS-232, RS-422/485	
	GT2103-PMBDS2	24 V DC				RS-232 × 2 channels	
GT2103-PMBLS	5 V DC	RS-422 (FXCPU connection only)					
GS21	GS2110	GS2110-WTBD-N NEW	10" WVGA	TFT color 65536 colors	Black	24 V DC	GOT SIMPLE Series
	GS2107	GS2107-WTBD-N NEW	7" WVGA				

*1 To comply with the ATEX directive and KCs regulation, protective sheet (GT25-□□PSCC-UC) and special fitting (GT25-□□FIT-EXS) in the "Options" list (page 200) are required separately. (Only protective sheet is required for GT2508-VTWD.) Communication units and option units cannot be used. When using these units, GOT does not conform to the standards. For the details, please refer to the Technical Bulletin "GOT2000 Series in Compliance with the ATEX Directive and KCs Certification Requirements" (No. GOT-A-0101) on the Mitsubishi Electric Factory Automation Global website (www.MitsubishiElectric.com/fa/).

*2 The lower part of the panel including the USB environmental protection cover is black.

GOT + CC-Link IE Field Network communication unit sets

Classification		Model	Screen size	Display section Display color	Panel color	Power	Remarks
GT27	GT2715	GT2715-XTBA-GF	15" XGA	TFT color 65536 colors	Black	100 to 240 V AC	GOT + GT15-J71GF13-T2
		GT2715-XTBD-GF			24 V DC		
	GT2712	GT2712-STBA-GF	12.1" SVGA		Black	100 to 240 V AC	
		GT2712-STBD-GF			24 V DC		
		GT2712-STWA-GF			White	100 to 240 V AC	
		GT2712-STWD-GF			24 V DC		
	GT2710	GT2710-STBA-GF	10.4" SVGA		Black	100 to 240 V AC	
		GT2710-STBD-GF			24 V DC		
		GT2710-VTBA-GF	10.4" VGA		Black	100 to 240 V AC	
		GT2710-VTBD-GF			24 V DC		
		GT2710-VTWA-GF			White	100 to 240 V AC	
		GT2710-VTWD-GF			24 V DC		
	GT2708	GT2708-STBA-GF	8.4" SVGA		Black	100 to 240 V AC	
		GT2708-STBD-GF			24 V DC		
GT2708-VTBA-GF		8.4" VGA	Black	100 to 240 V AC			
GT2708-VTBD-GF			24 V DC				
GT2705	GT2705-VTBD-GF	5.7" VGA	Black	24 V DC			
GT25	GT2512	GT2512-STBA-GF	12.1" SVGA	Black	100 to 240 V AC		
		GT2512-STBD-GF		24 V DC			
	GT2510	GT2510-VTBA-GF	10.4" VGA	Black	100 to 240 V AC		
		GT2510-VTBD-GF		24 V DC			
		GT2510-VTWA-GF		White	100 to 240 V AC		
		GT2510-VTWD-GF		24 V DC			
	GT2508	GT2508-VTBA-GF	8.4" VGA	Black	100 to 240 V AC		
		GT2508-VTBD-GF		24 V DC			
		GT2508-VTWA-GF		White	100 to 240 V AC		
		GT2508-VTWD-GF		24 V DC			

Product List

Communication units

Product name	Model	Specifications	Supported model							
			GT27	GT25	GT25 Wide	GT25 Rugged	GT23	GT21 Wide	GT21	GS21-W-N NEW
Ethernet communication unit *1	GT25-J71E71-100	Data transfer method: 100BASE-TX, 10BASE-T AUTO MDI/MDI-X	●	● ^{*11}	—	—	—	—	—	—
	GT15-RS2-9P	RS-232 serial communication unit (D-sub 9-pin male)	●	● ^{*11}	—	—	—	—	—	—
Serial communication unit	GT15-RS4-9S	RS-422/485 serial communication unit (D-sub 9-pin female) *1 *2	●	● ^{*11}	—	—	—	—	—	—
	GT15-RS4-TE	RS-422/485 serial communication unit (terminal block) *1 Can be used only when connected with temperature controllers/ indicating controllers by RS-485 connection or at the GOT multi- drop connection	●	● ^{*11}	—	—	—	—	—	—
Q bus connection unit	GT15-QBUS	Q bus connection (1 channel) unit standard model	●	● ^{*11}	—	—	—	—	—	—
	GT15-QBUS2	Q bus connection (2 channels) unit standard model	●	● ^{*11}	—	—	—	—	—	—
	GT15-75QBUSL	Q bus connection (1 channel) unit slim model *3	●	● ^{*11}	—	—	—	—	—	—
	GT15-75QBUS2L	Q bus connection (2 channels) unit slim model *3	●	● ^{*11}	—	—	—	—	—	—
MELSECNET/H communication unit	GT15-J71LP23-25	Normal station unit (optical loop)	●	● ^{*11}	—	—	—	—	—	—
	GT15-J71BR13	Normal station unit (coaxial bus)	●	● ^{*11}	—	—	—	—	—	—
CC-Link IE TSN communication unit	GT25-J71GN13-T2	Local station (device station) unit	●	● ^{*11}	—	—	—	—	—	—
CC-Link IE Controller Network communication unit	GT15-J71GP23-SX	Normal station unit (optical loop)	●	● ^{*11}	—	—	—	—	—	—
CC-Link IE Field Network communication unit	GT15-J71GF13-T2	Intelligent device station unit	●	● ^{*11}	—	—	—	—	—	—
CC-Link communication unit	GT15-J61BT13	Intelligent device station unit CC-Link Ver. 2 compliant	●	● ^{*11}	—	—	—	—	—	—
Field network adapter unit	GT25-FNADP	Supported network: PROFIBUS DP, DeviceNet *4	●	● ^{*11}	—	—	—	—	—	—
Wireless LAN communication unit *5 *6	GT25-WLAN	IEEE802.11b/g/n compliant, built-in antenna, wireless LAN access point (base station), station (client), connection to personal computer, tablet, smartphone Compliance with: Japan Radio Law *7, FCC standards *8, RE Directive *13 (R&TTE Directive *9), SRRRC *9, KC *9, Radio Equipment Regulations (UKCA)*14	●	● ^{*11}	●	●	—	—	—	—
Serial multi-drop connection unit	GT01-RS4-M	For GOT multi-drop connection	●	●	●	●	●	●	● ^{*10}	—
Connection conversion adapter	GT10-9PT5S	For connecting the RS-422/485 (D-Sub 9-pin connector) and RS-422/485 (terminal block)	—	● ^{*12}	—	—	—	—	—	—
RS-232/485 signal conversion adapter	GT14-RS2T4-9P	For connecting the RS-232 (D-Sub 9-pin connector) and RS- 485 (terminal block)	—	● ^{*12}	—	—	—	—	—	—

*1 May not be able to be used depending on the connection target. For details, please refer to the GOT2000 Series Connection Manual.

*2 Cannot be used when connected with temperature controllers or indicating controllers by RS-485 (2-wire type) connection.

*3 Cannot be stacked with other units.

*4 The unit should be used with an Anybus® CompactCom M40 network communication module manufactured by HMS. Please purchase the module by specifying the article number.

Supported network	Communication module product name	Communication module article number
PROFIBUS DP	ABCC-M40-DPV1	AB6910-B, AB6910-C
DeviceNet	ABCC-M40-DEV	AB6909-B, AB6909-C

*5 Data transfer in wireless LAN communication may not be as stable as that in cable communication. A packet loss may occur depending on the surrounding environment and the installation location. Be sure to perform a confirmation of operation before using this product.

*6 When [Operation Mode] is set to [Access Point] in [Wireless LAN Setting] of GT Designer3, up to five stations are connectable to the wireless LAN access point (base station).

*7 The product with hardware version A or later complies with the regulation. The product with hardware version A can be used only in Japan.

*8 The product with hardware version B or later complies with the regulation. The product with hardware version B or later can be used in Japan, the United States, the EU member states, Switzerland, Norway, Iceland, and Liechtenstein.

*9 The product with hardware version D or later complies with the regulation. The product with hardware version D or later can be used in Japan, the United States, the EU member states, Switzerland, Norway, Iceland, Liechtenstein, China (for details, please refer to the GOT2000 Series Wireless LAN Communication Unit User's Manual IB-0800522), and South Korea.

*10 Available to GT2104-RTBD, GT2103-PMBD, and GT2103-PMBDS.

*11 Not available to GT2505-VTBD, GT2506HS-VTBD, and GT2505HS-VTBD.

*12 Only available to GT2505-VTBD.

*13 The product complies with the RE Directive from March 31, 2017.

*14 The product with hardware version G or later (manufactured from October 2021) complies with the regulation. The product with hardware version G or later can be used in Japan, the United States, the EU member states, the UK, Switzerland, Norway, Iceland, Liechtenstein, China (for details, please refer to the GOT2000 Series Wireless LAN Communication Unit User's Manual IB-0800522), and South Korea.

Communication units for GT25 Handy GOT

Product name	Model	Specifications	Supported model	
			GT2506 Handy	GT2505 Handy
Serial multi-drop connection unit	GT01-RS4-M	For GOT multi-drop connection	●	—
Connection conversion adapter	GT10-9PT5S	For connecting the RS-422/485 (D-Sub 9-pin connector) and RS-422/485 (terminal block)	● ^{*1}	—

*1 Usable only when the connector conversion box GT16H-CNB-42S is used.

Option units

Product name	Model	Specifications	Supported model								
			GT27	GT25	GT25 Wide	GT25 Handy	GT25 Rugged	GT23	GT21 Wide	GT21	GS21-W-N NEW
Printer unit	GT15-PRN	USB device (PictBridge) for printer connection, 1 channel Cable for connection between printer unit and printer (3m) included	●	● ^{*3}	—	—	—	—	—	—	—
Multimedia unit	GT27-MMR-Z	For video input (NTSC/PAL), 1 channel, recording video/ playing video files	● ^{*1}	—	—	—	—	—	—	—	—
Video input unit	GT27-V4-Z	For video input (NTSC/PAL), 4 channels	● ^{*1}	—	—	—	—	—	—	—	—
RGB input unit	GT27-R2	For analog RGB input, 2 channels (simultaneous display)	● ^{*1}	—	—	—	—	—	—	—	—
Video/RGB input unit	GT27-V4R1-Z	For video input (NTSC/PAL), 4 channels/analog RGB, 1 channel input	● ^{*1}	—	—	—	—	—	—	—	—
RGB output unit	GT27-ROUT	For analog RGB output, 1 channel (slim unit)	● ^{*1}	—	—	—	—	—	—	—	—
Digital video output unit	GT27-VHOUT	For digital video output, 1 channel HDMI Type A connector	● ^{*1}	—	—	—	—	—	—	—	—
Sound output unit	GT15-SOUT	For sound output (φ3.5 stereo pin jack)	●	● ^{*3}	—	—	—	—	—	—	—
External I/O unit	GT15-DIOR	For connecting an external I/O device and an operation panel (negative common input, source type output)	●	● ^{*3}	—	—	—	—	—	—	—
	GT15-DIO	For connecting an external I/O device and an operation panel (positive common input, sink type output)	●	● ^{*3}	—	—	—	—	—	—	—
SD memory card unit	GT21-03SDCD	For mounting an SD memory card	—	—	—	—	—	—	—	● ^{*2}	—

*1 Not available to GT2705-VTBD.

*3 Not available to GT2505-VTBD.

*2 Only available to GT2103-PMBD, GT2103-PMBDS, and GT2103-PMBDS2.

Software

Product name	Model	Description	Supported model										
			GT27	GT25	GT25 Wide	GT25 Handy	GT25 Rugged	GT23	GT21 Wide	GT21	GS21-WA-NEW		
HMI/GOT Screen Design Software MELSOFT GT Works3	SW1DND-GTWK3-EC	English Version Site license product *1	DVD	●	●	●	●	●	●	●	●	●	●
FA Integrated Engineering Software MELSOFT iQ Works *2 *3	SW2DND-IQWK-E	English Version Standard license product	DVD	●	●	●	●	●	●	●	●	●	●
GT Works Text to Speech License *6	SW1DND-GTVO-M	Standard license product		●	● ⁷	●	—	●	—	—	—	—	—
GT Works3 Add-on License for GOT2000 Enhanced Drive Control (Servo) Project Data *8	SW1DND-GTSV-MZ	Standard license product		●	●	●	●	●	—	—	—	—	—
License key for GT SoftGOT2000 *4	GT27-SGTKEY-U	For USB port		—	—	—	—	—	—	—	—	—	—
Remote Personal Computer Operation Function (Ethernet) License *5	GT25-PCRAKEY-1	1 license		●	●	●	●	●	—	—	—	—	—
	GT25-PCRAKEY-5	5 licenses		●	●	●	●	●	—	—	—	—	—
	GT25-PCRAKEY-10	10 licenses		●	●	●	●	●	—	—	—	—	—
	GT25-PCRAKEY-20	20 licenses		●	●	●	●	●	—	—	—	—	—
VNC Server Function License *5	GT25-VNCSKEY-1	1 license (License for GOT remote access function)		●	●	●	●	●	—	●	—	●	NEW
	GT25-VNCSKEY-5	5 licenses		●	●	●	●	●	—	●	—	●	NEW
	GT25-VNCSKEY-10	10 licenses		●	●	●	●	●	—	●	—	●	NEW
	GT25-VNCSKEY-20	20 licenses		●	●	●	●	●	—	●	—	●	NEW
MES I/F Function License *5	GT25-MESIFKEY-1	1 license		●	●	●	●	●	—	—	—	—	—
	GT25-MESIFKEY-5	5 licenses		●	●	●	●	●	—	—	—	—	—
	GT25-MESIFKEY-10	10 licenses		●	●	●	●	●	—	—	—	—	—
	GT25-MESIFKEY-20	20 licenses		●	●	●	●	●	—	—	—	—	—
GOT Mobile Function License *5	GT25-WEBSKEY-1	1 license		●	●	●	●	●	—	—	—	—	—
	GT25-WEBSKEY-5	5 licenses		●	●	●	●	●	—	—	—	—	—
	GT25-WEBSKEY-10	10 licenses		●	●	●	●	●	—	—	—	—	—
	GT25-WEBSKEY-20	20 licenses		●	●	●	●	●	—	—	—	—	—
GOT Mobile Function License for GT SoftGOT2000 *9	SGT2K-WEBSKEY-1	1 license		—	—	—	—	—	—	—	—	—	—
	SGT2K-WEBSKEY-5	5 licenses		—	—	—	—	—	—	—	—	—	—

*1 Anyone can use the product as long as that person belongs to the business office (including overseas offices) of the corporation that purchased the product, or to the same public vocational training facility or other educational institution as the corporation.
 *2 Volume license product and additional license product are also available. For more details, please refer to the MELSOFT iQ Works catalog (L/NA)08232ENG).
 *3 The product includes the following software.
 · System Management Software [MELSOFT Navigator]
 · Motion Controller Engineering Software [MELSOFT MT Works2]
 · Robot Engineering Software [MELSOFT RT ToolBox3]
 · Setting/monitoring tools for the C Controller module and MELSECWinCPU [MELSOFT CW Configurator]
 · MITSUBISHI ELECTRIC FA Library
 * RT ToolBox3 mini (simplified version) will be installed if iQ Works product ID is used. When RT ToolBox3 (with simulation function) is required, please purchase RT ToolBox3.
 *4 To use GT SoftGOT2000, each personal computer requires a license key for GT SoftGOT2000.
 *5 One license is required for one GOT.
 *6 To edit sound files, each personal computer requires one license.
 *7 GT2505-VTBD does not support the sound output function.
 *8 Each personal computer requires an add-on license to use add-on projects.
 *9 Each personal computer with GT SoftGOT2000 installed requires one license.

Application package

Product name	Model	Description	Supported model										
			GT27	GT25	GT25 Wide	GT25 Handy	GT25 Rugged	GT23	GT21 Wide	GT21	GS21-WA-NEW		
iQ Monozukuri Process Remote Monitoring *1	AP30-PRM001AA-MA	1 license		●	●	●	●	●	●	●	●	●	● ²
	AP30-PRM001AA-MB	5 licenses		●	●	●	●	●	●	●	●	●	● ²
	AP30-PRM001AA-MC	10 licenses		●	●	●	●	●	●	●	●	●	● ²
iQ Monozukuri ANDON *3	AP30-ADN001AA-MA	1 license		●	●	●	●	●	—	—	—	—	—
	AP30-ADN001AA-MB	5 licenses		●	●	●	●	●	—	—	—	—	—
	AP30-ADN001AA-MC	10 licenses		●	●	●	●	●	—	—	—	—	—
	AP30-ADN001AA-MD	15 licenses		●	●	●	●	●	—	—	—	—	—
	AP30-ADN001AA-ME	20 licenses		●	●	●	●	●	—	—	—	—	—

*1 Process Remote Monitoring setting tool, iQ Monozukuri Process Remote Monitoring template project for GT SoftGOT2000, and the Process Remote Monitoring license are included.
 *2 Supported by GT2104-RTBD and GT2103-PMBD only.
 *3 Contents Publisher, project file of the GOT for iQ Monozukuri ANDON (template screens), GOT Mobile function license, and the iQ Monozukuri ANDON license are included.

Product List

Options

Product name	Model	Specifications	Supported model									
			GT27	GT25	GT25 Wide	GT25 Rugged	GT23	GT21 Wide	GT21	GS21-W-N NEW		
Protective sheet *1	GT27-15PSGC	For 15"	●	—	—	—	—	—	—	—	—	
	GT25-12PSGC	For 12.1"	●	●	—	—	—	—	—	—	—	
	GT25-10PSGC	For 10.4"	●	●	—	—	—	—	—	—	—	
	GT25-08PSGC	For 8.4"	●	●	—	—	—	—	—	—	—	
	GT25-05PSGC	For 5.7"	●	—	—	—	—	—	—	—	—	
	GT25-05PSGC-2	For 5.7"	—	●	—	—	—	—	—	—	—	
	GT25-12WPSGC	NEW For 12.1" wide models	●	—	●	—	—	—	—	—	—	
	GT25-10WPSGC	For 10.1" wide models	—	—	●	—	—	—	—	—	—	
	GT21-07WPSGC	For 7" wide models	—	—	●	—	—	●	—	—	—	
	GT27-15PSCC	For 15"	●	—	—	—	—	—	—	—	—	
	GT25-12PSCC	For 12.1"	●	●	—	—	—	—	—	—	—	
	GT25-10PSCC	For 10.4"	●	●	—	—	—	—	—	—	—	
	GT25-08PSCC	For 8.4"	●	●	—	—	—	—	—	—	—	
	GT25-05PSCC	For 5.7"	●	—	—	—	—	—	—	—	—	
	GT25-05PSCC-2	For 5.7"	—	●	—	—	—	—	—	—	—	
	GT25-12WPSCC	NEW For 12.1" wide models	—	—	●	—	—	—	—	—	—	
	GT25-10WPSCC	For 10.1" wide models	—	—	●	—	—	—	—	—	—	
	GT21-07WPSCC	For 7" wide models	—	—	●	—	—	●	—	—	—	
	GT25-12PSCC-UC *9	For 12.1"	● *9	●	—	—	—	—	—	—	—	
	GT25-10PSCC-UC *9	For 10.4"	● *9	● *9	—	—	●	—	—	—	—	
	GT25-08PSCC-UC *9	For 8.4"	●	● *9	—	—	●	—	—	—	—	
GT21-04RPSGC-UC	For 4.3"	●	—	—	—	—	—	●	—	—		
GT21-03PSGC-UC	For 3.8"	—	—	—	—	—	—	—	●	—		
GT21-04RPSCC-UC	For 4.3"	—	—	—	—	—	—	—	●	—		
GT21-03PSCC-UC	For 3.8"	—	—	—	—	—	—	—	●	—		
Antibacterial/antiviral protective sheet	GT25-12PSAC	NEW For 12.1"	●	● *15	—	—	—	—	—	—	—	
	GT25-10PSAC	NEW For 10.4"	●	● *15	—	—	—	—	—	—	—	
	GT25-08PSAC	NEW For 8.4"	●	● *15	—	—	—	—	—	—	—	
UV protective sheet (for the rugged model) *13	GT25T-07WPSVC	For 7" rugged model	—	—	—	●	—	—	—	—	—	
Environmental protection sheet (for the open frame model)	GT25F-12ESGS	For 12.1"	—	● *7	—	—	—	—	—	—	—	
	GT25F-10ESGS	For 10.4"	—	● *7	—	—	—	—	—	—	—	
	GT25F-08ESGS	For 8.4"	—	● *7	—	—	—	—	—	—	—	
USB environmental protection cover	GT25-UCOV	For 15"/12.1"/10.4"/8.4"	●	●	—	—	—	—	—	—	—	
	GT25-05UCOV	For 5.7"	●	—	—	—	—	—	—	—	—	
	GT21-WUCOV	For 12.1" wide models/ 10.1" wide models/ 7" wide models/5.7"	—	●	●	—	—	●	—	—	—	
Protective cover for oil *3	GT20-15PCO	For 15"	●	—	—	—	—	—	—	—	—	
	GT20-12PCO	For 12.1"	●	●	—	—	—	—	—	—	—	
	GT20-10PCO	For 10.4"	●	●	—	—	●	—	—	—	—	
	GT20-08PCO	For 8.4"	●	●	—	—	●	—	—	—	—	
	GT25-05PCO	For 5.7"	●	—	—	—	—	—	—	—	—	
	GT25-05PCO-2	For 5.7"	—	●	—	—	—	—	—	—	—	
	GT21-12WPCO	NEW For 12.1" wide models	—	—	●	—	—	—	—	—	—	
	GT21-10WPCO	For 10.1" wide models	—	—	●	—	—	—	—	—	—	
	GT21-07WPCO	For 7" wide models	—	—	●	—	—	●	—	—	—	
	GT25T-07WPCO *14	For 7" rugged model	—	—	—	●	—	—	—	—	—	
GT21-04RPCO	For 4.3"	—	—	—	—	—	—	—	●	—		
GT10-20PCO	For 3.8"	—	—	—	—	—	—	—	—	●		
Stand	GT15-90STAND	For 15"	●	—	—	—	—	—	—	—	—	
	GT15-80STAND	For 12.1"	●	●	—	—	—	—	—	—	—	
	GT15-70STAND	For 10.4"/8.4"	●	●	—	—	●	—	—	—	—	
	GT25-10WSTAND	For 10.1" wide models	—	—	●	—	—	—	—	—	—	
	GT21-07WSTAND	For 7" wide models	—	—	●	—	—	●	—	—	—	
	GT25T-07WSTAND	For 7" rugged model	—	—	—	●	—	—	—	—	—	
	GT05-50STAND	For 5.7"	●	●	—	—	—	—	—	—	—	
Memory card	SD memory card	NZ1MEM-2GBSD	SD memory card for GOT, 2 GB	●	●	●	●	●	●	●	●	
		NZ1MEM-4GBSD	SDHC memory card for GOT, 4 GB	●	●	●	●	●	●	●	●	
		NZ1MEM-8GBSD	SDHC memory card for GOT, 8 GB	●	●	●	●	●	●	●	●	
		NZ1MEM-16GBSD	SDHC memory card for GOT, 16 GB	●	●	●	●	●	●	●	●	
	CF card	GT05-MEM-128MC	CF card for GT27-MMR-Z, 128 MB	●	—	—	—	—	—	—	—	—
		GT05-MEM-256MC	CF card for GT27-MMR-Z, 256 MB	●	—	—	—	—	—	—	—	—
		GT05-MEM-512MC	CF card for GT27-MMR-Z, 512 MB	●	—	—	—	—	—	—	—	—
		GT05-MEM-1GC	CF card for GT27-MMR-Z, 1 GB	●	—	—	—	—	—	—	—	—
		GT05-MEM-2GC	CF card for GT27-MMR-Z, 2 GB	●	—	—	—	—	—	—	—	—
		GT05-MEM-4GC	CF card for GT27-MMR-Z, 4 GB	●	—	—	—	—	—	—	—	—
		GT05-MEM-8GC	CF card for GT27-MMR-Z, 8 GB	●	—	—	—	—	—	—	—	—
GT05-MEM-16GC	CF card for GT27-MMR-Z, 16 GB	●	—	—	—	—	—	—	—	—		

Options

Product name	Model	Specifications	Supported model								
			GT27	GT25	GT25 Wide	GT25 Rugged	GT23	GT21 Wide	GT21	GS21-W-N NEW	
Memory card adaptor	GT05-MEM-ADPC	Conversion adapter from CF card for GT27-MMR-Z to memory card (TYPE II)	●	—	—	—	—	—	—	—	
Attachment ^{*11}	GT15-70ATT-98	For 10.4"	For replacing GT168□, GT158□, A985GOT ^{*4}		●	●	—	—	●	—	—
	GT15-70ATT-87		For replacing A870GOT-SWS/TWS or A8GT-70GOT-TB/TW/SB/SW		●	●	—	—	●	—	—
	GT15-60ATT-97	For 8.4"	For replacing GT167□, GT157□, A97□GOT		●	●	—	—	●	—	—
	GT15-60ATT-96		For replacing A960GOT		●	●	—	—	●	—	—
	GT15-60ATT-87		For replacing A870GOT-EWS, A8GT-70GOT-EB/EW, A77GOT-EL, A77GOT-EL-S5/S3		●	●	—	—	●	—	—
	GT15-60ATT-77	For 5.7"	For replacing A77GOT-CL, A77GOT-CL-S5/S3, A77GOT-L, A77GOT-L-S5/S3		●	●	—	—	●	—	—
	GT15-50ATT-95W		For replacing A956WGOT, F940WGOT		●	●	—	—	—	—	—
	GT15-50ATT-85		For replacing A85□GOT		●	●	—	—	—	—	—
GT21-04RATT-40	For 4.3"	For replacing GT104□	—	—	—	—	—	—	—	● ^{*8}	
Battery	GT11-50BAT	Battery for backup of SRAM data, clock data, and system status log data ^{*6} .	● (For replacement)	● ^{*12} (For replacement)	● (For replacement)	● (For replacement)	● (Option)	● (For replacement)	● ^{*5} (For replacement)	—	
Special fitting ^{*9}	GT25-12FIT-EXS	For 12.1"	For compliance with the ATEX directive and KCs regulation		● ^{*9}	—	—	—	—	—	
	GT25-10FIT-EXS	For 10.4"			● ^{*9}	● ^{*9}	—	—	—	—	
Panel Mount HMI Speaker ^{*16}	FA1-GT0S04W	Items included in product package: speaker, audio cable (1 m), power supply connector, cable clamp, user's manual	● ^{*17}	● ^{*17} ^{*18}	●	● ^{*19}	—	—	—	—	

- *1 The white model does not have the front USB interface. It is recommended to use the products that the USB environmental protection cover area is closed.
- *2 When using the product with the USB environmental protection cover area closed, the front USB interface cannot be used.
- *3 Check if the protective cover for oil can be used in the actual environment before use. When using the cover, the front USB interface and human sensor cannot be used.
- *4 Including the GP250□ and GP260□ manufactured by Schneider Electric Japan Holdings Ltd.
- *5 GT2103-PMBD, GT2103-PMBDS, GT2103-PMBDS2, and GT2103-PMBLS do not have a built-in battery.
- *6 GT21 does not support the system status log data backup function.
- *7 GT2512F-STNA, GT2512F-STND, GT2510F-VTNA, GT2510F-VTND, GT2508F-VTNA, and GT2508F-VTND only.
- *8 Only available to GT2104-RTBD.
- *9 Necessary for the GOT to comply with the ATEX directive and KCs regulation. For applicable GOT models, please contact your local sales office.
- *10 The protective sheet is shaped not to cover the USB environmental protection cover.
- *11 An attachment is usable when the control panel has a thickness of 2 to 3 mm. When an attachment is used, the GOT is not IP67F-rated.
- *12 Cannot be used with GT2506HS-VTBD.
- *13 The UV protective sheet for the rugged model does not comply with IP66F and IP67F.
- *14 The protective cover for oil for the rugged model does not comply with IP66F.
- *15 Not available to GT2512F-STNA, GT2512F-STND, GT2510F-VTNA, GT2508F-VTND, GT2508F-VTND, GT2506HS-VTBD, and GT2505HS-VTBD.
- *16 For the details of the product, please contact MITSUBISHI ELECTRIC ENGINEERING COMPANY LIMITED.
- *17 A sound output unit (GT15-SOUT) should be mounted on the extension interface of the GOT.
- *18 Excluding GT2505-VTBD.
- *19 The model can be used within the specification range of the Panel Mount HMI Speaker. For detailed specifications, please refer to the user's manual of the speaker. For the user's manual, please contact your local sales office of MITSUBISHI ELECTRIC ENGINEERING COMPANY LIMITED.

Options for GT25 Handy GOT

Product name	Model	Specifications	Supported model	
			GT2506 Handy	GT2505 Handy
Protective sheet	GT16H-60PSC	For 6.5"	●	—
	GT14H-50PSC	For 5.7"		
Emergency stop switch guard cover	GT16H-60ESCOV	For 6.5"	●	—
	GT14H-50ESCOV	For 5.7"	—	●
Connector conversion box	GT16H-CNB-42S	For converting the Handy GOT signals into individual signals for the terminal block, D-sub connector, and Ethernet RJ45.	●	● ^{*11}
	GT16H-CNB-37S	For converting the Handy GOT signals into individual signals for the terminal block and Ethernet RJ45.	●	●
	GT11H-CNB-37S	For converting the Handy GOT signals into individual signals for the terminal block and D-sub connector.	—	●
Wall-mounting attachment for Handy GOT	GT14H-50ATT	For GT2505 Handy GOT	—	●
SD memory card	NZ1MEM-2GBSD	SD memory card for GOT, 2 GB	●	●
	NZ1MEM-4GBSD	SDHC memory card for GOT, 4 GB	●	●
	NZ1MEM-8GBSD	SDHC memory card for GOT, 8 GB	●	●
	NZ1MEM-16GBSD	SDHC memory card for GOT, 16 GB	●	●
Battery	GT15-BAT	Battery for backup of SRAM data, clock data, and system status log data (for replacement)	●	—
	GT11-50BAT		—	●

*1 Only Ethernet connection is supported. Serial communication connection is not supported.

Product List

Cables

Product name	Model	Cable length	Recommended product ¹	Specifications	Supported model ¹⁶									
					GT27	GT25	GT25 Wide	GT25 Rugged	GT23	GT21 Wide	GT21	GS21-WAN NEW		
QCPU bus connection cable	QCPU connection cable GOT-to-GOT connection cable	GT15-QC06B	0.6 m	○	QCPU ↔ GOT GOT ↔ GOT	●	● ^{*13}	—	—	—	—	—	—	
		GT15-QC12B	1.2 m											
		GT15-QC30B	3 m											
		GT15-QC50B	5 m											
		GT15-QC100B	10 m											
	QCPU connection cable GOT-to-GOT connection cable (long distance)	GT15-QC150BS	15 m	○	For connecting the QCPU and GOT (long distance), A9GT-QCNB is required For connecting the GOT and GOT (long distance)	●	● ^{*13}	—	—	—	—	—	—	
		GT15-QC200BS	20 m											
		GT15-QC250BS	25 m											
		GT15-QC300BS	30 m											
		GT15-QC350BS	35 m											
Bus extension connector box	A9GT-QCNB	—	—	Connect the connector box to the main base unit of PLC when connecting the QCPU and GOT (long distance).	●	● ^{*13}	—	—	—	—	—	—		
Bus connection cable ferrite core	GT15-QFC	—	○	Attach a ferrite core to the GOT-A900 bus connection cable when an existing GOT-A900 is replaced with a GOT2000. (two ferrite cores/set)	●	● ^{*13}	—	—	—	—	—	—		
RS-485 terminal block conversion unit	FA-LTBGT2R4CBL05	0.5 m	○	RS-485 terminal block conversion unit With a cable for connecting RS-422/485 (connector) of GOT2000 and a RS-485 terminal block conversion unit	●	● ^{*13}	●	●	—	—	—	—		
	FA-LTBGT2R4CBL10	1 m												
	FA-LTBGT2R4CBL20	2 m												
RS-422 conversion cable	FA-CNV2402CBL	0.2 m	○	For connecting the QCPU/L02SCPU(-P) and the RS-422 cable (GT01-C□R4-25P, GT10-C□R4-25R, GT21-C□R4-25P5) For connecting the L6ADP-R2 and the RS-422 cable (GT01-C□R4-25P, GT10-C□R4-25P, GT21-C□R4-25P5) [MINI-DIN 6-pin ↔ D-sub 25-pin]	●	●	●	●	●	●	● ^{*12}	●		
	FA-CNV2405CBL	0.5 m												
RS-422 cable	QnA/ACPU direct connection cable	GT01-C30R4-25P	3 m	—	For connecting a QnA/ACPU/Motion CPU (A series)/FXCPU and the GOT For connecting an RS-422 connector conversion cable (FA-CNV□CBL) and the GOT For connecting a serial communication module and the GOT For connecting a peripheral connection module (AJ65BT-G4-S3) and the GOT [D-sub 25-pin ↔ D-sub 9-pin]	●	●	●	●	●	●	● ^{*3-7}	●	
		GT01-C100R4-25P	10 m											
		GT01-C200R4-25P	20 m											
		GT01-C300R4-25P	30 m											
		GT10-C30R4-25P	3 m											
		GT10-C100R4-25P	10 m											
		GT10-C200R4-25P	20 m											
		GT10-C300R4-25P	30 m											
	Computer link connection cable	GT10-C300R4-25P	30 m	—	For connecting a serial communication module and the GOT For connecting a peripheral connection module (AJ65BT-G4-S3) and the GOT [D-sub 25-pin ↔ separate wire (connector terminal block 9-pin)]	—	—	—	—	—	—	● ^{*10}	—	
		GT21-C30R4-25P5	3 m	—	For connecting a QnACPU and the GOT For connecting an RS-422 connector conversion cable (FA-CNV□CBL) and the GOT For connecting a serial communication module and the GOT For connecting a peripheral connection module (AJ65BT-G4-S3) and the GOT [D-sub 25-pin ↔ separate wire (connector terminal block 5-pin)] * GT2103-PMBD cannot be connected to Q00CPU, Q00CPU, Q01CPU, A Series, or FX1/FX2 Series.	—	—	—	—	—	—	—	● ^{*2}	—
		GT21-C100R4-25P5	10 m											
		GT21-C200R4-25P5	20 m											
	GT21-C300R4-25P5	30 m												
	Computer link connection cable	GT09-C30R4-6C	3 m	○	For connecting a serial communication module and the GOT For connecting a computer link module and the GOT [separate wire ↔ D-sub 9-pin]	●	●	●	●	●	●	●	● ^{*3-7}	●
		GT09-C100R4-6C	10 m											
		GT09-C200R4-6C	20 m											
		GT09-C300R4-6C	30 m											
	FXCPU direct connection cable	FXCPU communication expansion board connection cable	GT01-C10R4-8P	1 m	—	For connecting the FXCPU and GOT For connecting the FXCPU communication expansion board and GOT [MINI-DIN 8-pin ↔ D-sub 9-pin]	●	●	●	●	●	●	● ^{*3-7}	●
			GT01-C30R4-8P	3 m										
			GT01-C100R4-8P	10 m										
			GT01-C200R4-8P	20 m										
			GT01-C300R4-8P	30 m										
			GT10-C10R4-8P	1 m										
		FXCPU direct connection cable	FXCPU communication expansion board connection cable	GT10-C30R4-8P	3 m	—	For connecting the FXCPU and GOT For connecting the FXCPU communication expansion board and GOT [MINI-DIN 8-pin ↔ separate wire (connector terminal block 9-pin)]	—	—	—	—	—	—	● ^{*4}
GT10-C100R4-8P				10 m										
GT10-C200R4-8P				20 m										
GT10-C300R4-8P				30 m										
GT21-C10R4-8P5				1 m										
GT21-C30R4-8P5				3 m										
FXCPU communication expansion board connection cable	FXCPU communication expansion board connection cable	GT21-C100R4-8P5	10 m	—	For connecting the FXCPU and GOT For connecting the FXCPU communication expansion board and GOT [MINI-DIN 8-pin and separate wire (connector terminal block 5-pin)]	—	—	—	—	—	—	● ^{*2}	—	
		GT21-C200R4-8P5	20 m											
		GT21-C300R4-8P5	30 m											
		GT10-C10R4-8PPL	1 m											
		GT10-C10R4-8PC	1 m											
		GT10-C30R4-8PC	3 m											
RS-422 connector conversion cable	RS-422 connector conversion cable	GT10-C100R4-8PC	10 m	—	For connecting the FXCPU and GOT For connecting the FXCPU communication expansion board and GOT [MINI-DIN 8-pin ↔ connector terminal block 9-pin with separate wire connected]	—	—	—	—	—	—	● ^{*4}	—	
		GT10-C200R4-8PC	20 m											
		GT10-C300R4-8PC	30 m											
		GT10-C02H-9SC	0.2 m			—	For connecting a PLC and the GOT [D-sub 9-pin ↔ separate wire (connector terminal block 9-pin)]	—	—	—	—	—	—	● ^{*10}

Cables

Product name	Model	Cable length	Recommended product ¹	Specifications	Supported model ¹⁶									
					GT27	GT25	GT25 Wide	GT25 Rugged	GT23	GT21 Wide	GT21	GS21-WAN NEW		
RS-232 cable	Q/LCPU direct connection cable	GT01-C30R2-6P	3 m	—	For connecting the Q/LCPU and GOT For connecting L6ADP-R2 and GOT/personal computer (GT SoftGOT2000) [MINI-DIN 6-pin ↔ D-sub 9 pin]	●	●	●	●	●	●	● ^{*5*}	●	
		GT10-C30R2-6P	3 m	—	For connecting the Q/LCPU and GOT [MINI-DIN 6-pin ↔ separate wire (connector terminal block 9-pin)] For connecting multiple GOTs [MINI-DIN 6-pin ↔ separate wire (connector terminal block 9-pin)]	—	—	—	—	—	—	● ^{*6*}	—	
	FXCPU communication expansion board connection cable	GT01-C30R2-9S	3 m	—	For connecting the FXCPU communication expansion board and GOT/personal computer (GT SoftGOT2000) For connecting an FXCPU communication special adapter and GOT/personal computer (GT SoftGOT2000) [D-sub 9-pin ↔ D-sub 9 pin]	●	●	●	●	●	●	● ^{*5*}	●	
	FXCPU communication special adapter connection cable					●	●	●	●	●	●	● ^{*5*}	●	
	FXCPU communication special adapter connection cable	GT01-C30R2-25P	3 m	—	For connecting an FXCPU communication special adapter and GOT/personal computer (GT SoftGOT2000) [D-sub 25-pin ↔ D-sub 9 pin]	●	●	●	●	●	●	● ^{*5*}	●	
	Computer link connection cable	GT09-C30R2-9P	3 m	○	For connecting a serial communication module and the GOT For connecting a computer link module and the GOT For connecting a peripheral connection module (AJ65BT-R2N) and the GOT [D-sub 9-pin ↔ D-sub 9 pin]	●	●	●	●	●	●	● ^{*5*}	●	
	CC-Link (G4) connection cable					●	●	●	●	●	●	● ^{*5*}	●	
	Computer link connection cable	GT09-C30R2-25P	3 m	○	For connecting a serial communication module and the GOT For connecting a computer link module and the GOT [D-sub 25-pin ↔ D-sub 9 pin]	●	●	●	●	●	●	● ^{*5*}	●	
RS-232 connector conversion cable	GT10-C02H-6PT9P	0.2 m	—	For connecting a PLC and the GOT For connecting multiple GOTs For connecting a barcode reader, RFID, or serial printer and the GOT [D-sub 9-pin ↔ MINI-DIN 6-pin]	—	—	—	—	—	—	● ^{*11*}	—		
Data transfer cable	GT01-C30R2-6P	3 m	—	For connecting the GOT and a personal computer [MINI-DIN 6-pin ↔ D-sub 9-pin] * This cable is usable for the FA transparent function only, and cannot be used to transfer screen or OS data.	—	—	—	—	—	—	● ^{*11*}	—		
Conversion cable for connecting external I/O unit	GT15-C03HTB	0.3 m	○	For connecting an external I/O unit (GT15-DIO) and external I/O interface unit (A8GT-C05TK, A8GT-C30TB, user-fabricated cable) for GOT-A900	●	● ^{*13*}	—	—	—	—	—	—	—	
Analog RGB cable	GT15-C50VG	5 m	○	For connecting an RGB image output device (external monitor, personal computer, or others) and the GOT	●	—	—	—	—	—	—	—	—	
USB cable	Data transfer cable Printer connection cable	GT09-C30USB-6P	3 m	○	For connecting a personal computer (screen design software) and the GOT For connecting a personal computer (GT SoftGOT2000) and QnU/L/FXCPU For connecting a PictBridge-compatible printer and printer unit (GT15-PRN) [USB-A ↔ USB Mini-B]	●	●	●	●	●	●	● ^{*9*}	● ^{*9*}	●
						●	●	●	●	●	●	● ^{*9*}	● ^{*9*}	●
Panel-mounted USB port extension	GT14-C10EXUSB-4S	1 m	—	For routing the USB port (host) of the GOT rear face to the front side of the control panel	●	●	●	● ^{*17*}	—	●	—	—	—	
	GT10-C10EXUSB-5S	1 m	—	For routing the USB port (device) of the GOT rear face to the front side of the control panel	● ^{*14*}	● ^{*14*}	—	● ^{*17*}	—	—	—	● ^{*15*}	—	

¹ FA-LTBGT2R4CBL□, FA-CNV240□CBL are developed by Mitsubishi Electric Engineering Company Limited and sold through your local sales office. The other products listed are developed by Mitsubishi Electric Systems & Service Co., LTD. and sold through your local sales office.

² This cable is usable for GT2103-PMBD.

³ This cable is usable for GT2104-RTBD, GT2103-PMBDS.

⁴ This cable is usable for GT2104-RTBD, GT2103-PMBDS, GT2103-PMBLS. For GT2103-PMBLS, use a 3 m or shorter cable.

⁵ This cable is usable for GT2103-PMBDS, GT2103-PMBDS2.

⁶ This cable is usable for GT2104-RTBD, GT2103-PMBDS2.

⁷ GT2104-RTBD, GT2103-PMBDS is possible to correspond by combining the GT10-C02H-9SC type RS-422 connector conversion cable.

⁸ GT2103-PMBDS, GT2103-PMBDS2 is possible to correspond by combining the GT10-C02H-6PT9P type RS-232 connector conversion cable.

⁹ This cable is not usable for the printer connection.

¹⁰ This cable is usable for GT2104-RTBD, GT2103-PMBDS.

¹¹ This cable is usable for GT2103-PMBDS, GT2103-PMBDS2.

¹² This cable is usable for GT2104-RTBD, GT2103-PMBD, GT2103-PMBDS.

¹³ This cable is not usable for GT2505-VTBD.

¹⁴ This cable is usable for GT2712-STWA, GT2712-STWD, GT2710-VTWA, GT2710-VTWD, GT2512F-STNA, GT2512F-STND, GT2510-VTWA, GT2510-VTWD, GT2510F-VTNA, GT2510F-VTND, GT2508-VTWA, GT2508-VTWD, GT2508F-VTNA, GT2508F-VTND.

¹⁵ This cable is usable for GT2104-RTBD, GT2103-PMBD, GT2103-PMBDS, GT2103-PMBDS2, GT2103-PMBLS.

¹⁶ Note that the usable connection types and cables differ depending on the GOT model. For the details, please refer to the GOT2000 Series Connection Manual.

¹⁷ When using a rugged model, the panel-mounted USB port extension does not comply with IP66F.

Product List

Cables for GT25 Handy GOT

Product name		Model	Cable length	Recommended product ¹	Specifications	Supported model	
						GT2506 Handy	GT2505 Handy
External connection cable (to connect the connector conversion box)		GT16H-C30-42P	3 m	—	For connection between the Handy GOT and the connector conversion box (GT16H-CNB-42S)	●	—
		GT16H-C60-42P	6 m	—		●	—
		GT16H-C100-42P	10 m	—		●	—
		GT16H-C30-37PE	3 m	—	For connection between the Handy GOT and the connector conversion box (GT16H-CNB-37S)	●	—
		GT16H-C60-37PE	6 m	—		●	—
		GT16H-C100-37PE	10 m	—		●	—
		GT14H-C30-42P	3 m	—	For connection between the Handy GOT and the connector conversion box (GT16H-CNB-42S)	—	●
	GT14H-C60-42P	6 m	—	—		●	
	GT14H-C100-42P	10 m	—	—		●	
External connection cable (to connect the connector conversion box or relay cable) ²		GT11H-C30-37P	3 m	—	For connection between the Handy GOT and the connector conversion box (GT16H-CNB-37S and GT11H-CNB-37S)	—	●
		GT11H-C60-37P	6 m	—		—	●
		GT11H-C100-37P	10 m	—	For connection between the Handy GOT and the relay cable (GT11HC15R□-□P)	—	●
External connection cable (to connect separate wire) ²		GT11H-C30	3 m	—	For connection between the Handy GOT and the FA device, the power supply, or the operation switch	—	●
		GT11H-C60	6 m	—		—	●
		GT11H-C100	10 m	—		—	●
Relay cable (to connect the external connection cable and a programmable controller) ²		GT11H-C15R4-8P	1.5 m	—	For connecting to a programmable controller	—	●
		GT11H-C15R4-25P	1.5 m	—		—	●
		GT11H-C15R2-6P	1.5 m	—		—	●
RS-422 conversion cable		FA-CNV2402CBL	0.2 m	○	For connecting the QCPU/L02SCPU(-P) and the RS-422 cable (GT01-C□R4-25P, GT10-C□R4-25P, GT21-C□R4-25P5) For connecting the L6ADP-R2 and the RS-422 cable (GT01-C□R4-25P, GT10-C□R4-25P, GT21-C□R4-25P5) [MINI-DIN 6-pin ↔ D-sub 25-pin]	●	●
		FA-CNV2405CBL	0.5 m			●	●
RS-422 cable ³	QnA/FXCPU direct connection cable Computer link connection cable CC-Link (G4) connection cable	GT01-C30R4-25P	3 m	—	For connecting the QnA/ACPU/Motion CPU (A series)/FXCPU and the GOT For connecting the RS-422 connector conversion cable (FA-CNV□CBL) and the GOT For connecting the serial communication module and the GOT For connecting the peripheral connection module (AJ65BT-G4-S3) and the GOT [D-sub 25-pin ↔ D-sub 9-pin]	●	●
		GT01-C100R4-25P	10 m			●	●
	Computer link connection cable	GT09-C30R4-6C	3 m	○	For connecting the serial communication module and GOT For connecting a computer link module and GOT [separate wire ↔ D-sub 9-pin]	●	●
		GT09-C100R4-6C	10 m			●	●
	FXCPU direct connection cable FXCPU communication expansion board connection cable	GT01-C10R4-8P	1 m	—	For connecting the FXCPU and GOT For connecting the FXCPU communication expansion board and GOT [MINI-DIN 8-pin ↔ D-sub 9 pin]	●	●
		GT01-C30R4-8P	3 m			●	●
GT01-C100R4-8P		10 m	●			●	
RS-232 cable	Q/LCPU direct connection cable	GT11H-C30R2-6P	3 m	—	For connecting a QCPU or LCPU and the connector conversion box for Handy GOT (GT11H-CNB-37S/GT16H-CNB-42S)	●	●
	FXCPU communication expansion board connection cable FXCPU communication special adapter connection cable	GT01-C30R2-9S	3 m	—	For connecting the FXCPU communication expansion board and GOT/ personal computer (GT SoftGOT2000) For connecting an FXCPU communication special adapter and GOT/ personal computer (GT SoftGOT2000) [D-sub 9-pin ↔ D-sub 9 pin]	●	●
		GT01-C30R2-25P	3 m	—	For connecting an FXCPU communication special adapter and GOT/ personal computer (GT SoftGOT2000) [D-sub 25-pin ↔ D-sub 9 pin]	●	●
	Computer link connection cable CC-Link (G4) connection cable	GT09-C30R2-9P	3 m	○	For connecting a serial communication module and GOT For connecting a computer link module and GOT For connecting the peripheral connection module (AJ65BT-R2N) and GOT [D-sub 9-pin ↔ D-sub 9 pin]	●	●
		GT09-C30R2-25P	3 m	○	For connecting a serial communication module and GOT For connecting a computer link module and GOT [D-sub 25-pin ↔ D-sub 9 pin]	●	●
USB cable	Data transfer cable Printer connection cable	GT09-C30USB-5P	3 m	○	For connecting a personal computer (screen design software) and GOT For connecting a personal computer (GT SoftGOT2000) and QnU/L/ FXCPU For connecting a PictBridge-compatible printer and printer unit (GT15-PRN) [USB-A ↔ USB Mini-B]	●	●

¹ FA-CNV240□CBL is developed by Mitsubishi Electric Engineering Company Limited and sold through your local sales office.
The other products listed are developed by Mitsubishi Electric Systems & Service Co., LTD. and sold through your local sales office.

² Use the cable version C or later.

³ The total length of the cables between the Handy GOT and a controller includes the length of an external cable. A cable of 20 m or longer cannot be used for GT2506HS-VTBD and GT2505HS-VTBD.

Cables for non-Mitsubishi FA products

RS-232 and RS-422 cables are available from every manufacturer. For more details, please refer to the Mitsubishi Electric Factory Automation Global website (www.MitsubishiElectric.com/fa/) or the GOT2000 Series Connection Manual.

Manuals

Manual name	Manual number
GOT2000 Series User's Manual (Hardware)	SH-081194ENG
GOT2000 Series User's Manual (Utility)	SH-081195ENG
GOT2000 Series User's Manual (Monitor)	SH-081196ENG
GOT2000 Series Connection Manual (Mitsubishi Products) For GT Works3 Version1	SH-081197ENG
GOT2000 Series Handy GOT Connection Manual For GT Works3 Version1	SH-081867ENG
GOT SIMPLE Series User's Manual	JY997D529011
GT Designer3 (GOT2000) Screen Design Manual	SH-081220ENG

Support

◆ Global support

Global FA Centers

Asia-Pacific

Shanghai FA Center

Mitsubishi Electric Automation (China) Ltd.
Shanghai FA Center
Mitsubishi Electric Automation Center, No.1386
Hongqiao Road, Shanghai, China
Tel: +86-21-2322-3030 / Fax: +86-21-2322-3000(9611#)

Beijing FA Center

Mitsubishi Electric Automation (China) Ltd.
Beijing FA Center
5/F, ONE INDIGO, 20 Jiuxianqiao Road Chaoyang
District, Beijing, China
Tel: +86-10-6518-8830 / Fax: +86-10-6518-2938

Tianjin FA Center

Mitsubishi Electric Automation (China) Ltd.
Tianjin FA Center
Room 2003 City Tower, No.35, Youyi Road, Hexi
District, Tianjin, China
Tel: +86-22-2813-1015 / Fax: +86-22-2813-1017

Shenzhen FA Center

Mitsubishi Electric Automation (China) Ltd.
Shenzhen FA Center
Level 8, Galaxy World Tower B, 1 Yabao Road, Longgang
District, Shenzhen, China
Tel: +86-755-2399-8272 / Fax: -

Guangzhou FA Center

Mitsubishi Electric Automation (China) Ltd.
Guangzhou FA Center
Rm.1006, A1Times E-PARK, No.276-282, Hanxi Road East,
Zhongcun Street, Panyu District, Guangzhou, China
Tel: +86-20-8923-6730 / Fax: +86-20-8923-6715

Taipei FA Center

SETSUYO ENTERPRISE CO., LTD.
3F, No.105, Wugong 3rd Road, Wugu District,
New Taipei City 24889, Taiwan
Tel: +886-2-2299-9917 / Fax: +886-2-2299-9963

Korea FA Center

Mitsubishi Electric Automation Korea Co., Ltd.
8F, Gangseo Hangang Xi-tower A, 401,
Yangcheon-ro, Gangseo-Gu, Seoul 07528, Korea
Tel: +82-2-3660-9632 / Fax: +82-2-3664-0475

ASEAN FA Center

Mitsubishi Electric Asia Pte. Ltd.
307 Alexandra Road, Mitsubishi Electric Building,
Singapore 159943
Tel: +65-6470-2475 / Fax: +65-6476-7439

Malaysia FA Center

Mitsubishi Electric Sales Malaysia Sdn. Bhd.
Lot 11, Jalan 51A/219, Seksyen 51A, 46100 Petaling Jaya,
Selangor Darul Ehsan, Malaysia
Tel: +60-3-7626-5080 / Fax: +60-3-7658-3544

Indonesia FA Center

PT. Mitsubishi Electric Indonesia Cikarang Office
Jl. Kenari Raya Blok G2-07A Delta Silicon 5,
Lippo Cikarang - Bekasi 17550, Indonesia
Tel: +62-21-2961-7797 / Fax: +62-21-2961-7794

Hanoi FA Center

Mitsubishi Electric Vietnam Co., Ltd.
Hanoi Branch Office
14 Floor, Capital Tower, 109 Tran Hung Dao Str., Cua Nam
Ward, Hoan Kiem Dist., Ha Noi, Vietnam
Tel: +84-24-3937-8075 / Fax: +84-24-3937-8076

Ho Chi Minh FA Center

Mitsubishi Electric Vietnam Co., Ltd.
11th & 12th Floor, Viettel Tower B, 285 Cach Mang
Thang 8 Street, Ward 12, District 10, Ho Chi Minh City,
Vietnam
Tel: +84-28-3910-5945 / Fax: +84-28-3910-5947

Thailand FA Center

Mitsubishi Electric Factory Automation (Thailand) Co., Ltd.
101, True Digital Park Office, 5th Floor, Sukhumvit Road,
Bang Chak, Prakanong, Bangkok, Thailand
Tel: +66-2682-6522-31 / Fax: +66-2682-6020

Philippines FA Center

MELCO Factory Automation Philippines Inc.
128, Lopez-Rizal St. Brgy, Highway Hills,
Mandaluyong City, MM, Philippines
Tel: +63-(0)2-8256-8042 / Fax: -

India Pune FA Center

Mitsubishi Electric India Pvt. Ltd.
Pune Branch
Emerald House, EL-3, J Block, M.I.D.C., Bhosari,
Pune - 411026, Maharashtra, India
Tel: +91-20-2710-2000 / Fax: +91-20-2710-2100

India Gurgaon FA Center

Mitsubishi Electric India Pvt. Ltd.
Gurgaon Head Office
Plot 517, Ground floor, Udyog Vihar Phase 3,
Gurugram 122008, Haryana, India
Tel: +91-124-463-0300 / Fax: +91-124-463-0399

India Bangalore FA Center

Mitsubishi Electric India Pvt. Ltd.
Bangalore Branch
Prestige Emerald, 6th Floor, Municipal No.2,
Madras Bank Road, Bangalore - 560001, Karnataka, India
Tel: +91-80-4020-1600 / Fax: +91-80-4020-1699

India Chennai FA Center

Mitsubishi Electric India Pvt. Ltd.
Chennai Branch
Citilights Corporate Centre No.1, Vivekananda
Road, Srinivasa Nagar, Chetpet, Chennai - 600031,
Tamil Nadu, India
Tel: +91-44-4554-8772 / Fax: +91-44-4554-8773

India Ahmedabad FA Center

Mitsubishi Electric India Pvt. Ltd.
Ahmedabad Branch
B/4, 3rd Floor, SAFAL Profitaire, Corporate Road,
Pralhadnagar, Satellite, Ahmedabad - 380015,
Gujarat, India
Tel: +91-79-6512-0063 / Fax: -

India Coimbatore FA Center

Mitsubishi Electric India Pvt. Ltd.
Coimbatore Branch
BMH Srinivas, 2nd Floor, Door No.1604, Trichy Road,
Near ICICI Bank, Coimbatore - 641018, Tamil Nadu, India
Tel: +91-422-438-5606 / Fax: -

Americas

North America FA Center

Mitsubishi Electric Automation, Inc.
500 Corporate Woods Parkway, Vernon Hills, IL 60061,
U.S.A.
Tel: +1-847-478-2100 / Fax: +1-847-478-2253

Mexico FA Center

Mitsubishi Electric Automation, Inc.
Queretaro Office
Parque Tecnológico Innovación Queretaro Lateral
Carretera Estatal 431, Km 2+200, Lote 91
Modulos 1 y 2 Hacienda la Machorra, CP 76246,
El Marques, Queretaro, Mexico
Tel: +52-442-153-6014 / Fax: -

Mexico City FA Center

Mitsubishi Electric Automation, Inc.
Mexico Branch
Boulevard Miguel de Cervantes Saavedra 301, Torre Norte
Piso 5, Int. 502, Ampliación Granada, Miguel Hidalgo,
Ciudad de México, México, C.P.11520
Tel: +52-55-3067-7500/ Fax: -

Mexico Monterrey FA Center

Mitsubishi Electric Automation, Inc.
Monterrey Office
Plaza Mirage, Av. Gonzalitos 460 Sur, Local 28, Col. San
Jeronimo, Monterrey, Nuevo Leon, C.P. 64640, Mexico
Tel: +52-55-3067-7599 / Fax: -

Brazil FA Center

**Mitsubishi Electric do Brasil Comercio e
Servicos Ltda.**
Avenida Adelino Cardana, 293, 21 andar, Bethaville,
Barueri SP, Brazil
Tel: +55-11-4689-3000 / Fax: +55-11-4689-3016

Europe

Europe FA Center

Mitsubishi Electric Europe B.V. Polish Branch
ul. Krakowska 48, 32-083 Balice, Poland
Tel: +48-12-347-65-00 / Fax: -

Germany FA Center

Mitsubishi Electric Europe B.V. German Branch
Mitsubishi-Electric-Platz 1, 40882 Ratingen, Germany
Tel: +49-2102-486-0 / Fax: +49-2102-486-7780

UK FA Center

Mitsubishi Electric Europe B.V. UK Branch
Travellers Lane, Hatfield, Hertfordshire, AL10 8XB, U.K.
Tel: +44-1707-27-8780 / Fax: +44-1707-27-8695

Italy FA Center

Mitsubishi Electric Europe B.V. Italian Branch
Campus, Energy Park Via Energy Park 14, Vimercate
20871 (MB) Italy
Tel: +39-039-60531 / Fax: +39-039-6053-312

Czech Republic FA Center

Mitsubishi Electric Europe B.V. Czech Branch
Pekarska 621/7, 155 00 Praha 5, Czech Republic
Tel: +420-734-402-587 / Fax: -

Turkey FA Center

Mitsubishi Electric Turkey Elektrik Urunleri A.S.
Serifali Mahallesi Kale Sokak No:41 Umraniye / Istanbul,
Turkey
Tel: +90-216-969-2500 / Fax: +90-216-661-4447

◆ Approval standards

Mitsubishi's products comply with various standards and laws.

Mitsubishi's products also comply with various international standards including UL standards, and maritime certifications. For the details on the approval model within each standard, please contact your local sales office.

<International standards>

Mark	Overview	Country/Region
CE	EMC Directive harmonized standards, Low Voltage Directive harmonized standards, RoHS Directive harmonized standards	EU member states
Ex	ATEX Directive harmonized standards	EU member states
UKCA	EMC Directive harmonized standards, Low Voltage Directive harmonized standards, RoHS Directive harmonized standards, ATEX Directive harmonized standards	Great Britain (England, Wales and Scotland)
UL	Safety standards Class I, Division 2	United States
cUL	Safety standards Class I, Division 2	Canada
KC	EMC standards	Korea
KCs	Safety standards	Korea

<Maritime certifications>

Abbrev.	Certification Organization	Country
ABS	American Bureau of Shipping	United States
BV	Bureau Veritas	France
DNV	DNV AS	Norway
LR	Lloyd's Register	England
NK	NIPPON KAIJI KYOKAI	Japan
RINA	Registro Italiano Navale	Italy

Factory Automation Global website

www.MitsubishiElectric.com/fa/

Mitsubishi Electric Factory Automation provides a mix of services to support its customers worldwide, through a consolidated global website. In addition to documents such as catalogs, manuals, and technical bulletins, the latest information about GOT will be posted on the website as soon as it becomes available.

Factory Automation Global website

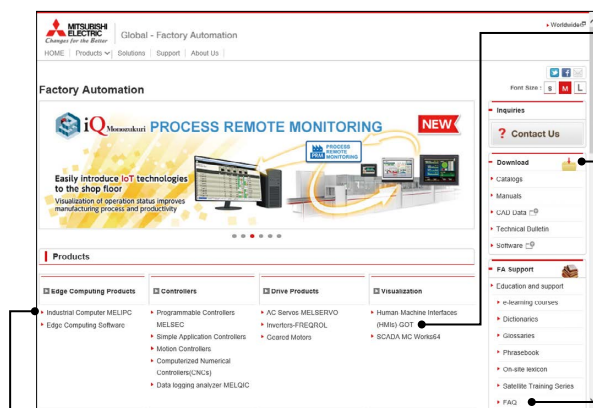

Industrial Computer MELIPC

The information about MELIPC MI3000 can be viewed from here.

Download

Various documents such as catalogs, manuals, and technical bulletins can be downloaded.

Human-Machine Interfaces (HMIs)-GOT top page

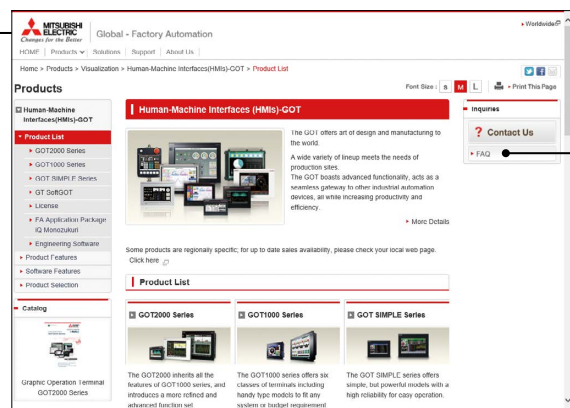

FAQ

Frequently asked questions about Mitsubishi Electric industrial devices including GOT can be viewed from here.

MELIPC MI3000

Panel computers equipped with integrated touch screens

For details

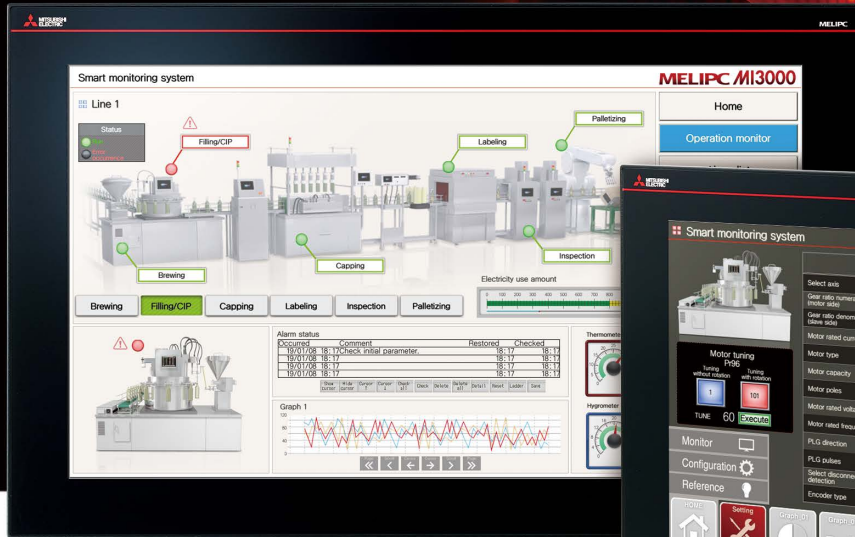

21.5" widescreen MI3321G-W



15" MI3315G-W

Beautiful, stunning, large screen monitor

Large 21.5-inch widescreen display and 15-inch display models are available. Colorful images are displayed with 16.77 million colors. Light-touch operation is realized with a PCAP touch panel that is widely used for smartphones and tablet devices.

Item	Specifications
Display	15"/21.5", TFT color LCD, 16.77 million colors
Resolution	Full HD, XGA
Backlight	LED
Internal storage	64 GB
Standard interface	Ethernet (3 ports), RS-232, RS-422/485, DisplayPort USB host (USB-A): 2 channels (USB 2.0), 2 channels (USB 3.0) Sound output
Extension interface	PCI Express® x 1 slot, (half size) x 1 mini PCI Express® Full size x 2 M.2 (2280) SATA x 1

Windows® 10 IoT Enterprise pre-installed

Not only familiar Windows® applications, but also user-created applications can be used to configure systems that meet requirements of individual customers.

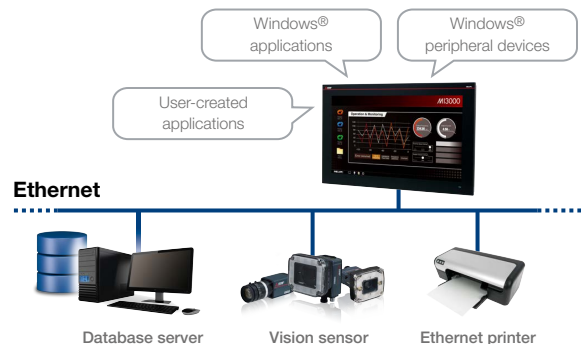

Various software pre-installed

Edgecross Basic Software, SLMP Data Collector, and GT SoftGOT2000 are pre-installed on MI3000. The data collected by Edgecross, SLMP Data Collector, and GT SoftGOT2000 can be monitored on the GT SoftGOT2000 screen.

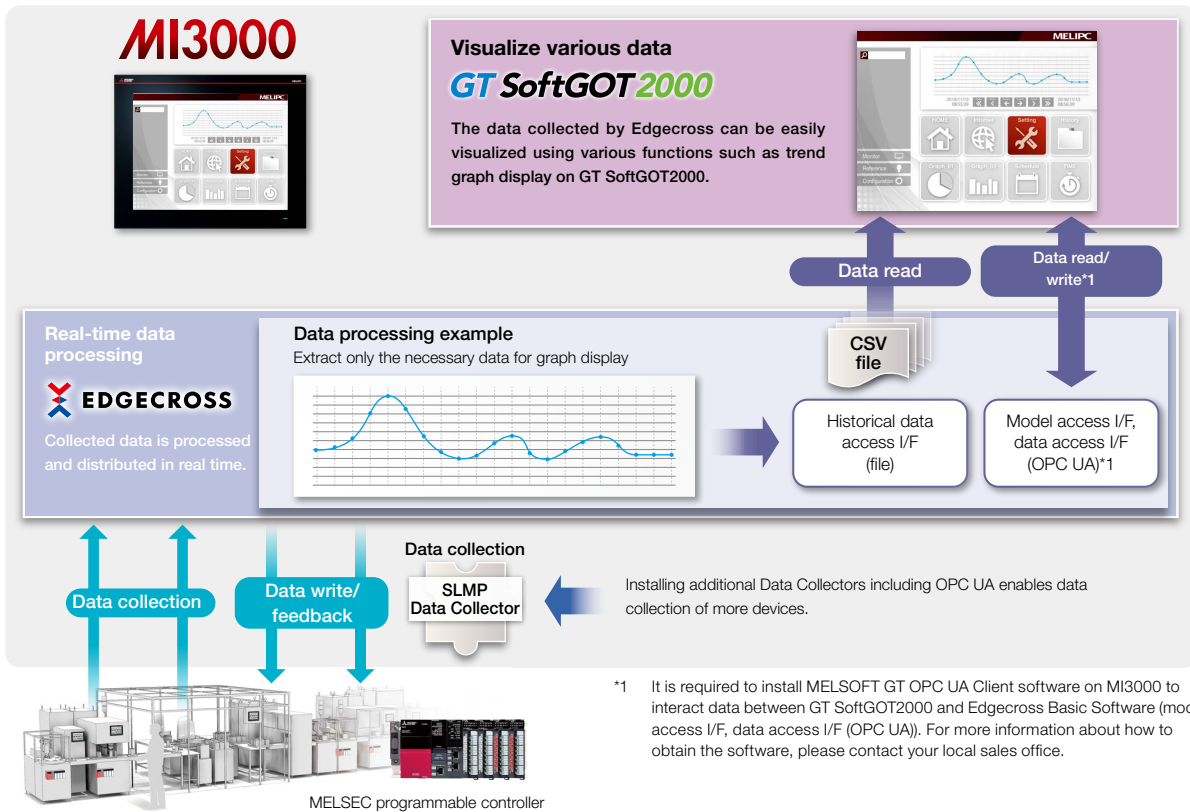

■ MELIPC MI3000 external appearance [rear face]

- 1 DisplayPort**
Output to an external monitor.
Screen can be displayed on a larger monitor.
- 2 M.2 (2280) SATA (inside the cover)**
Expand storage for collecting and storing large amounts of data.
- 3 4 PCI Express®/mini PCI Express® (inside the cover)**
Expand functions by using an expansion board.
- 5 Sound output**
For outputting sound by connecting a speaker with built-in amplifier.
To use sound notification on GT SoftGOT2000, sound files can be easily created with GT Designer3.
* For the details, please refer to page 136.
- 6 7 USB3.0/USB2.0**
Each interface has two ports for connecting to various USB compatible devices.
- 8 Ethernet (LAN A, LAN B, LAN C)**
Various Ethernet compatible devices can be connected to three ports. The network in the office can be separated from the one in the shop floor to enhance security.
- 9 10 RS-232/422/485**
For data collection from existing facilities.

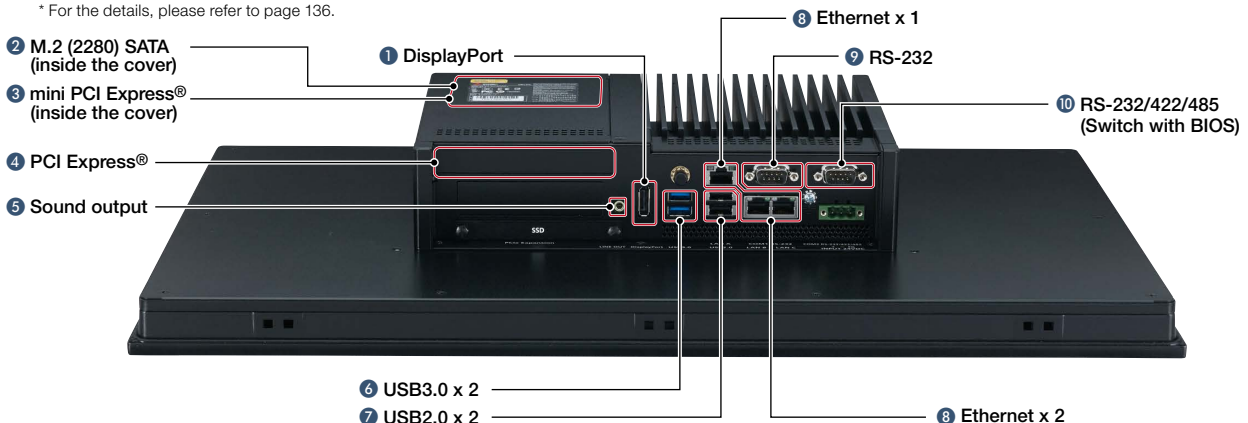

MELIPC MI3000

MELIPC MI3000

General specifications

Item	Specifications
Operating ambient temperature	0 °C to 55 °C
Storage ambient temperature	-20 °C to 60 °C
Operating ambient humidity	10% RH to 90% RH, non-condensing
Storage ambient humidity	10% RH to 90% RH, non-condensing
Vibration resistance	Compliant with IEC 60068-2-64, 5 to 500Hz, one hour in direction X, Y, Z each
Random vibration	
Shock resistance	3 Grms
	Compliant with IEC 60068-2-27, 10 G, half sine wave, 11 msec
Operating atmosphere	No greasy fumes, corrosive gas, flammable gas, excessive conductive dust, and direct sunlight (as well as at storage)
Operating altitude *3/4	—
Installation location	Inside control panel
Overvoltage category *1	II or less
Pollution degree *2	2 or less
Cooling method	Self-cooling
Grounding	Grounding with a ground resistance of 100 Ω or less by using a ground cable that has a cross-sectional area of 2 mm ² or more.

*1 This indicates the section of the power supply to which the equipment is assumed to be connected between the public electrical power distribution network and the machinery within the premises. Category II applies to equipment that is supplied with power from fixed facilities. The withstand surge voltage for the equipment with the rated voltage up to 300 V is 2500 V.

*2 This indicates the occurrence rate of conductive material in an environment where a device is used. Pollution degree 2 indicates an environment where only non-conductive pollution occurs normally and a temporary conductivity caused by condensation shall be expected depending on the conditions.

Power supply specifications

Item	Specifications	
	MI3321G-W	MI3315G-W
Rated input voltage	24 V DC	
Input voltage variable range	19.2 to 28.8 V DC	
Power consumption	Under the maximum load	90 W
	Stand alone	27 W
Applicable wire size	Single wiring (single wire, stranded wire): 0.2 to 2.5 mm ² (AWG24 to AWG14) Rod terminal with an insulation sleeve: 0.25 to 2.5 mm ² (AWG22 to AWG14) Double wiring (single wire, stranded wire): 0.2 to 1.5 mm ² (AWG24 to AWG16)	
Applicable solderless terminal	DN00508D (AWG20), DN00708D (AWG18), DN01508D (AWG16) (manufactured by DINKLE) Crimp tool: DNT13-0101 (manufactured by DINKLE)	
Applicable tightening torque (for terminal block terminal screws)	0.20 N·m (M2.5)	

*3 Do not use or store the product under pressure higher than the atmospheric pressure of altitude 0 m. Doing so may cause malfunction.

*4 No limitations to altitude. When used at a high altitude, the upper limits of the permissible voltage and the operating ambient temperature become lower. Please check performance before use at the customer side.

Performance specifications

Item	Specifications		
	MI3321G-W	MI3315G-W	
Display section *1 *2	Display device	TFT color LCD	
	Screen size	21.5" widescreen	
	Resolution	Full HD: 1920 × 1080	
	Display color	16.77 million	
	Backlight	LED backlight (not replaceable)	
	Backlight life	50,000 hours	
Touch panel	Type	PCAP (Projected Capacitive)	
	Simultaneous press	Max. 10 keys *3	
	Transmittance	90%±3%	
Panel color	Black		
Hardware	MPU	Intel® Core™ i3-6100U 2.30 GHz (Dual Core)	
	Memory capacity	RAM	8 GB
		ROM	64 GB
	Battery	Replacement	Not replaceable *4
	Life	4 years	
Software	OS	Windows® 10 IoT Enterprise 2016 LTSB (64 bit)	
	System language	At initial startup: English	
Additional storage	Interface	M.2(2280) SATA SSD x 1	
Extension interface	PCI Express®	x1 slot, (half size) x 1	
	mini PCI Express®	Full size x 2	
Built-in interface	Display (for external monitor output)	Interface	DisplayPort 1.4
		Connector	DisplayPort connector
		Number of ports	1
	Ethernet (LAN A, LAN B, LAN C)	Resolution*5	Max. 3840 × 2160
		Interface	10BASE-T, 100BASE-TX, 1000BASE-T (AUTO MDI/MDI-X)
		Number of ports	3
	RS-232	Connector for external wiring	RJ45
		Number of ports	1
		Transmission speed	300 to 115200 bps
	RS-232/RS-422/RS-485	Connector for external wiring	D-sub 9-pin (male)
		Interface	RS-232, RS-422, RS-485 (two wire system) Default: RS-232 *6
		Number of ports	1
	USB	Transmission speed	300 to 115200 bps
Connector for external wiring		D-sub 9-pin (male)	
Number of ports		• USB3.0: 2 • USB2.0: 2	
Sound output	Connector	USB Type-A	
	Interface	Audio Line-Out	
	Number of ports	1	
	Connector	Φ 3.5 mini-jack (3-prong)	
Built-in clock precision	Daily difference: -2 seconds to +2 seconds Monthly difference: -60 seconds to +60 seconds		
POWER LED	2 colors (blue and orange)		
Protective structure	Front: IP66		
Safety standards, radio laws (as of June 2023)	CE, UKCA, UL, cUL, KC, BSMI, CCC, FCC		
External dimensions	349.8(13.77) (H) × 558.4(21.98) (W) × 88.8(3.50) (D) mm(inch)	307.3(12.10) (H) × 383.2(15.09) (W) × 86(3.39) (D) mm(inch)	
Panel cutting dimensions	341.8(13.46) (H) × 550.3(21.67) (W) mm(inch)	298.5(11.75) (H) × 374.5(14.74) (W) mm(inch)	
Weight	9.8(21.6) kg(lb)	7.0(15.4) kg(lb)	

*1 As a characteristic of liquid crystal display panels, bright dots (always lit) and dark dots (never lit) may appear on the panel. Since liquid crystal display panels comprise a great number of display elements, the appearance of bright and dark dots cannot be reduced to zero. Individual differences in liquid crystal display panels may cause differences in color, uneven brightness and flickering. Note that these phenomena are characteristics of liquid crystal display panels and it does not mean the products are defective or damaged.

*2 Flickering may occur due to vibration, shock, or the display colors.

*3 Multiple touch keys cannot be pressed simultaneously while GT SoftGOT2000 is used.

*4 The battery cannot be removed by users. For the battery replacement, please contact your local sales office.

*5 Maximum resolution at 60 Hz.

*6 The interface can be switched between RS-232, RS-422, and RS-485 with the BIOS.

External dimensions

Unit : mm (inch)

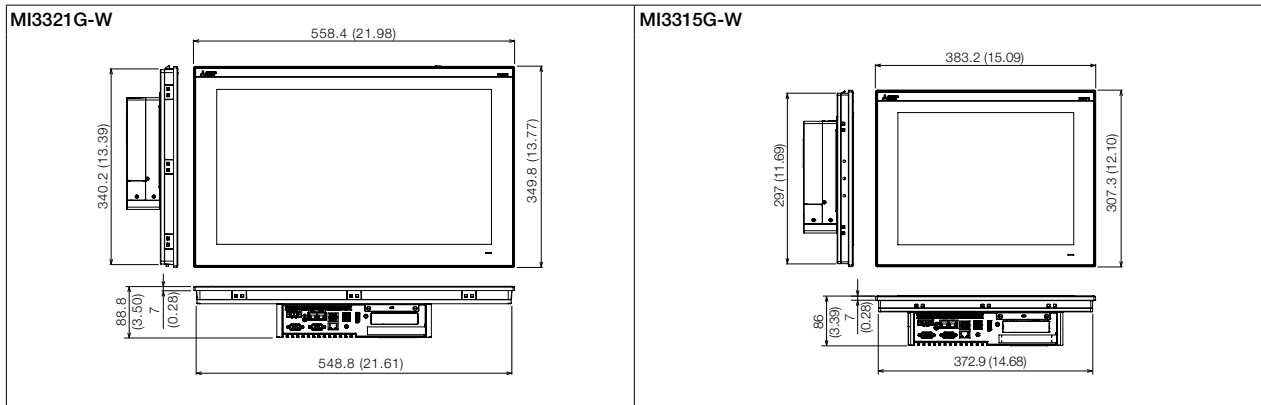

Panel cut dimensions

Unit : mm (inch)

Screen size	Model	A	B
21.5" widescreen	M3321G-W	550.3 (21.67)	341.8 (13.46)
15"	M3315G-W	374.5 (14.74)	298.5 (11.75)

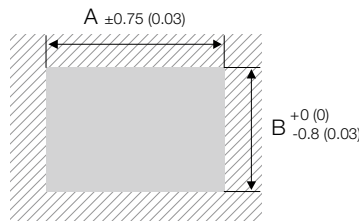

* Panel thickness: 2 mm to 6 mm
(0.08 inch to 0.24 inch)

Product list

MELIPC

Product name	Model	Screen size	Panel color	Outline
MELIPC MI3000	M3321G-W	21.5" widescreen, Full HD	Black	Edgecross Basic Software, SLMP Data Collector, GT SoftGOT2000 pre-installed
	M3315G-W	15" XGA	Black	

Option

Product name	Model	Outline
Network interface board	Q81BD-J71GF11-T2	PCI Express® bus compatible, CC-Link IE Field Network (master/local station)
	Q81BD-J71GP21-SX	PCI Express® bus compatible, CC-Link IE Controller Network (control/normal station)
	Q81BD-J71GP21S-SX	PCI Express® bus compatible, CC-Link IE Controller Network (control/normal station), with external power supply function

Engineering tool

Product name	Model	Outline	
HMI/GOT Screen Design Software MELSOFT GT Works3	SW1DND-GTWK3-EC	English Version	Site license product *1
GT Works Text to Speech License *2	SW1DND-GTVO-M	Standard license product	
GOT Mobile Function License for GT SoftGOT2000 *3	NEW SGT2K-WEBSKEY-5	SGT2K-WEBSKEY-1	1 license
		SGT2K-WEBSKEY-5	5 licenses

*1 Anyone can use the product as long as that person belongs to the business office (including overseas offices) of the corporation that purchased the product, or to the same public vocational training facility or other educational institution as the corporation.
 *2 To edit sound files, each personal computer requires one license.
 *3 One license is required for each personal computer on which GT SoftGOT2000 is installed.



For the details of MI3000, please refer to the MELIPC MI3000 catalog (L(NA)08600ENG).

Android and Google Chrome are trademarks or registered trademarks of Google LLC.
 Anybus is a registered trademark of HMS Industrial Networks AB.
 AXIS is a registered trademark of Axis AB in various jurisdictions.
 DisplayPort is a trademark owned by the Video Electronics Standards Association (VESA) in the United States and other countries.
 GENESIS64 and their respective modules are trademarks of ICONICS, Inc.
 Intel, Intel Core, and Intel Atom are trademarks of Intel Corporation or its subsidiaries in the U.S. and/or other countries.
 IOS is a trademark or registered trademark of Cisco in the U.S. and other countries and is used under license.
 Safari is a trademark of Apple Inc., registered in the U.S. and other countries.
 SD and SDHC Logos are registered trademarks or trademarks of SD-3C, LLC.
 MELDAS, MELSEC, iQ Platform, MELSOFT, GOT, CC-Link, CC-Link/LT, CC-Link IE are either trademarks or registered trademarks of Mitsubishi Electric Corporation in Japan and other countries.
 Microsoft, Windows, Windows Vista, Windows Server, Excel, Visual Basic, Visual C++, Visual Studio, Access, SQL Server are registered trademarks or trademarks of Microsoft Corporation in the United States, Japan and other countries.
 MODBUS is a registered trademark of SCHNEIDER ELECTRIC USA, INC.
 OPC is a trademark of OPC Foundation.
 Oracle is a registered trademark of Oracle Corporation and/or its affiliates in the United States and other countries.
 PCI Express is a registered trademark of PCI-SIG.
 PictBridge is a registered trademark of Canon Inc.
 PLCopen and related logos are registered trademarks of PLCopen.
 Unicode and the Unicode Logo are registered trademarks of Unicode, Inc. in the United States and other countries.
 VNC is a registered trademark of RealVNC Ltd. in the United States and other countries.
 Other product and company names are either trademarks or registered trademarks of their respective owners.

The actual color may differ slightly from the pictures in this catalog.
 The actual display may differ from what are shown on GOT screen images.

Precautions before use

This publication explains the typical features and functions of the products herein and does not provide restrictions or other information related to usage and module combinations. Before using the products, always read the product user manuals. Mitsubishi Electric will not be held liable for damage caused by factors found not to be the cause of Mitsubishi Electric; opportunity loss or lost profits caused by faults in Mitsubishi Electric products; damage, secondary damage, or accident compensation, whether foreseeable or not, caused by special factors; damage to products other than Mitsubishi Electric products; or any other duties.

For safe use

- To use the products given in this publication properly, always read the relevant manuals before beginning operation.
- The products have been manufactured as general-purpose parts for general industries, and are not designed or manufactured to be incorporated in a device or system used in purposes related to human life.
- Before using the products for special purposes such as nuclear power, electric power, aerospace, medicine or passenger-carrying vehicles, consult with Mitsubishi Electric.
- The products have been manufactured under strict quality control. However, when installing the products where major accidents or losses could occur if the products fail, install appropriate backup or fail-safe functions in the system.

Creating Solutions Together.



Low-voltage Power Distribution Products



Transformers, Med-voltage Distribution Products



Power Monitoring and Energy Saving Products



Power (UPS) and Environmental Products



Compact and Modular Controllers



Servos, Motors and Inverters



Visualization: HMIs



Edge Computing Products



Numerical Control (NC)



Collaborative and Industrial Robots



Processing machines: EDM, Lasers



SCADA, analytics and simulation software

Mitsubishi Electric's product lineup, from various controllers and drives to energy-saving devices and processing machines, all help you to automate your world. They are underpinned by software, innovative data monitoring, and modelling systems supported by advanced industrial networking and Edgecross IT/OT connectivity. Together with a worldwide partner ecosystem, Mitsubishi Electric factory automation (FA) has everything to make IoT and Digital Manufacturing a reality.

With a complete portfolio and comprehensive capabilities that combine synergies with diverse business units, Mitsubishi Electric provides a one-stop approach to how companies can tackle the shift to clean energy and energy conservation, carbon neutrality and sustainability, which are now a universal requirement of factories, buildings, and social infrastructure.

We at Mitsubishi Electric FA are your solution partners waiting to work with you as you take a step toward the realization of sustainable manufacturing and society through the application of automation. Let's automate the world together!

American Offices

USA Mitsubishi Electric Automation, Inc. 500 Corporate Woods Parkway, Vernon Hills, IL 60061, U.S.A. Tel: +1-847-478-2100	Mexico Mitsubishi Electric Automation, Inc. Mexico Branch Boulevard Miguel de Cervantes Saavedra 301, Torre Norte Piso 5, Ampliacion Granada, Miguel Hidalgo, Ciudad de Mexico, Mexico, C.P.11520 Tel: +52-55-3067-7500	Brazil Mitsubishi Electric do Brasil Comercio e Servicos Ltda. Avenida Adelino Cardana, 293, 21.o andar, Bethaville, Barueri SP, Brazil Tel: +55-11-4689-3000
--	---	--

Asia-Pacific Offices

China Mitsubishi Electric Automation (China) Ltd. Mitsubishi Electric Automation Center, No.1386 Hongqiao Road, Shanghai, China Tel: +86-21-2322-3030	Taiwan SETSUYO ENTERPRISE CO., LTD. 6F, No.105, Wugong 3rd Road, Wugu District, New Taipei City 24889, Taiwan Tel: +886-2-2299-2499	Korea Mitsubishi Electric Automation Korea Co., Ltd. 7F to 9F, Gangseo Hangang Xi-tower A, 401, Yangcheon-ro, Gangseo-Gu, Seoul, Korea Tel: +82-2-6103-9460
Singapore Mitsubishi Electric Asia Pte. Ltd. 307 Alexandra Road, Mitsubishi Electric Building, Singapore 159943 Tel: +65-6473-2486	Malaysia Mitsubishi Electric Sales Malaysia Sdn. Bhd. Lot 11, Jalan 51A/219, Seksyen 51A, 46100 Petaling Jaya, Selangor Darul Ehsan, Malaysia Tel: +60-3-7626-5000	Indonesia PT. Mitsubishi Electric Indonesia Gedung Jaya 8th Floor, JL. MH. Thamrin No.12, Jakarta Pusat 10340, Indonesia Tel: +62-21-3192-6461
Vietnam Mitsubishi Electric Vietnam Co., Ltd. 11th & 12th Floor, Viettel Tower B, 285 Cach Mang Thang Tam Street, Ward 12, District 10, Ho Chi Minh City, Vietnam Tel: +84-28-3910-5945	Thailand Mitsubishi Electric Factory Automation (Thailand) Co., Ltd. 101, True Digital Park Office, 5th Floor, Sukhumvit Road, Bang Chak, Prakanong, Bangkok, Thailand Tel: +66-2092-8600	Philippines MELCO Factory Automation Philippines Inc. 128, Lopez-Rizal St. Brgy. Highway Hills, Mandaluyong City, MM, Philippines Tel: +63-(0)2-8256-8042
India Mitsubishi Electric India Pvt. Ltd. Pune Branch ICC-Devi Gaurav Technology Park, Unit no. 402, Fourth Floor, Survey no. 191-192 (P), Opp. Vallabh Nagar Bus Depot, Pune - 411018, Maharashtra, India Tel: +91-20-4624-2100	Australia Mitsubishi Electric Australia Pty. Ltd. 348 Victoria Road, P.O. Box 11, Rydalmere, N.S.W. 2116, Australia Tel: +61-2-9684-7777	

European Offices

Germany Mitsubishi Electric Europe B.V. German Branch Mitsubishi-Electric-Platz 1, 40882 Ratingen, Germany Tel: +49-2102-486-0	UK Mitsubishi Electric Europe B.V. UK Branch Travellers Lane, UK-Hatfield, Hertfordshire, AL10 8XB, U.K. Tel: +44-1707-28-8780	Italy Mitsubishi Electric Europe B.V. Italian Branch Campus, Energy Park Via Energy Park 14, Vimercate 20871 (MB) Italy Tel: +39-039-60531
Spain Mitsubishi Electric Europe B.V. Spanish Branch Carretera de Rubi 76-80-Appdo. 420, E-08174 Sant Cugat del Valles (Barcelona), Spain Tel: +34-935-65-3131	France Mitsubishi Electric Europe B.V. French Branch 2, rue de l'Union-92565 Rueil-Malmaison Cedex-France Tel: +33-1-55-68-55-68	Czech Republic Mitsubishi Electric Europe B.V. Czech Branch, Prague Office Pekarska 621/7, 155 00 Praha 5, Czech Republic Tel: +420-734-402-587
Turkey Mitsubishi Electric Turkey A.S. Umraniye Branch Serifali Mah. Kale Sok. No:41 Umraniye / Istanbul, Turkey Tel: +90-216-969-2500	Poland Mitsubishi Electric Europe B.V. Polish Branch ul. Krakowska 48, 32-083 Balice, Poland Tel: +48-12-347-65-00	South Africa Adroit Technologies 20 Waterford Office Park, 189 Witkoppen Road, Fourways, South Africa Tel: +27-11-658-8100

The release date varies depending on the product and your region. For details, please contact your local sales office.

MITSUBISHI ELECTRIC CORPORATION
 HEAD OFFICE: TOKYO BLDG., 2-7-3, MARUNOUCHI, CHIYODA-KU, TOKYO 100-8310, JAPAN
 NAGOYA WORKS: 1-14, YADA-MINAMI 5, HIGASHI-KU, NAGOYA, JAPAN