

FACTORY AUTOMATION

Mitsubishi Electric Programmable Controller MELSEC iQ-F Series

Quick Connection Guide FREQROL-D700 Serial Communication



MELSEC iQ-F
series



FREQROL-D700

INTRODUCTION

Thank you for purchasing the Mitsubishi Electric MELSEC iQ-F series programmable controllers. This manual describes the settings for the inverter communication function of the FX5 CPU module. Before using this product, please read this manual and relevant manuals carefully and develop familiarity with the specifications to handle the product correctly. When applying the program examples provided in this manual to an actual system, ensure the applicability and confirm that it will not cause system control problems.

Regarding use of this product

- This product has been manufactured as a general-purpose part for general industries, and has not been designed or manufactured to be incorporated in a device or system used in purposes related to human life.
- Before using the product for special purposes such as nuclear power, electric power, aerospace, medicine or passenger movement vehicles, please contact Mitsubishi Electric sales office.
- This product has been manufactured under strict quality control. However when installing the product where major accidents or losses could occur if the product fails, install appropriate backup or failsafe functions into the system.

Note

- If in doubt at any stage during the installation of the product, always consult a professional electrical engineer who is qualified and trained to the local and national standards. If in doubt about the operation or use, please contact your local Mitsubishi Electric representative.
- Mitsubishi Electric will not accept responsibility for actual use of the product based on these illustrative examples. Please use it after confirming the function and safety of the equipment and system.
- The content, specification etc. of this manual may be changed, for improvement, without notice.
- The information in this manual has been carefully checked and is believed to be accurate; however, if you notice a doubtful point, an error, etc., please contact your local Mitsubishi Electric representative. When doing so, please provide the manual number given at the end of this manual.

CONTENTS

INTRODUCTION	2
KEY FEATURES TO FACILITATE OPERATION	4
1. PREPARATION	5
1.1 Preparatory Steps.....	5
1.2 Required Products.....	5
1.3 System Configuration	7
1.4 Wiring.....	8
1.4.1 Cable terminal treatment and wiring (single wire)	9
1.4.2 Making a LAN cable	10
1.5 Connecting a Terminating Resistor.....	12
2. INVERTER SETTINGS	13
2.1 Names of the Parts on the Operation Panel.....	13
2.2 Parameter List	14
2.2.1 Inverter communication settings (required settings)	14
2.2.2 Parameter settings (for adjustment and operation).....	14
2.3 Parameter Settings.....	15
2.4 Inverter Reset	17
3. PROGRAMMABLE CONTROLLER SETTINGS	18
3.1 Parameter Settings Using GX Works3 (Required Settings)	18
3.2 Communication Test Programs.....	20
3.3 Communication Settings Using GX Works3.....	21
3.4 Writing Data to the Programmable Controller	23
4. CHECKING COMMUNICATION STATUS	25
5. EXAMPLE PROGRAMS	26
5.1 Operation	26
5.1.1 Example programs	27
5.2 Operation Check.....	29
6. TROUBLESHOOTING	30
6.1 Checking Procedure.....	30
6.2 Checking the LED Status	31
6.3 Checking the Error Code.....	32
APPENDIX	35
Inverter Communication Instructions.....	35
Others	40
REVISIONS	43
WARRANTY.....	43
SAFETY PRECAUTIONS.....	43
TRADEMARKS	43

KEY FEATURES TO FACILITATE OPERATION

Point 1

Easy inverter control using dedicated instructions

Inverter control is facilitated by monitoring and controlling operations and reading and changing parameters using the dedicated instructions.

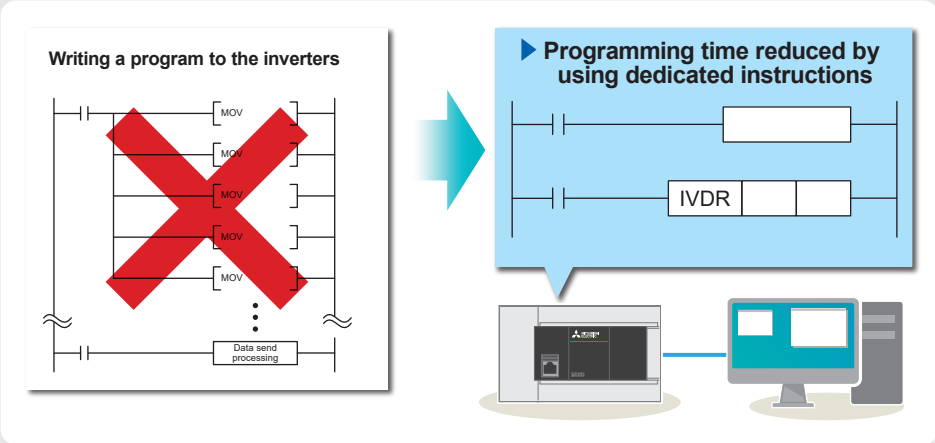

Point 2

Easy parameter setting using the setting dial

The scroll speed of the setting dial is adjustable, enhancing the usability. The non-slip surface treatment enables easier turning.

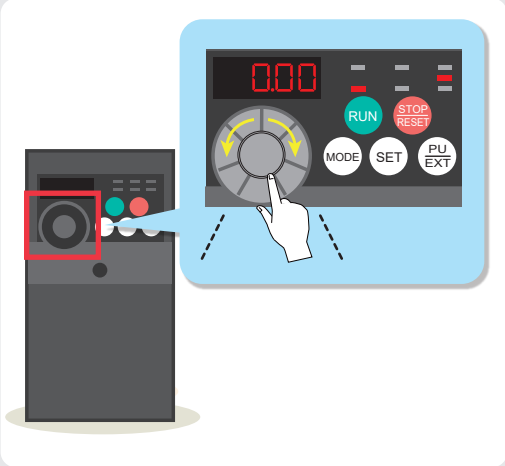

Point 3

Easy connection between internal ports

Maximum 16 inverters can be connected extensively, with the overall cable distance of 50 meters, by using the built-in RS-485 port of the CPU module.

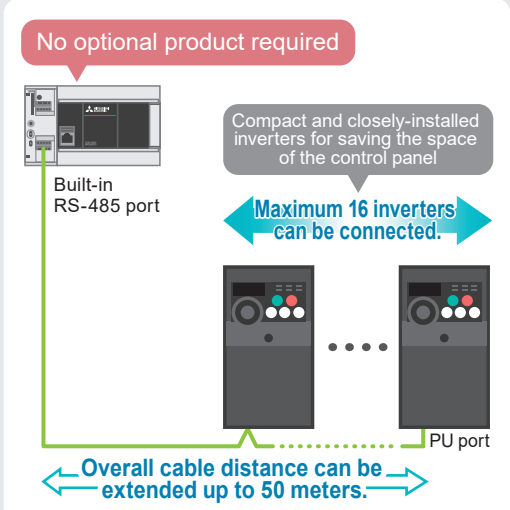

1. PREPARATION

Preparatory Steps

Required Products

System Configuration

Wiring

Connecting a Terminating Resistor

1.1 Preparatory Steps

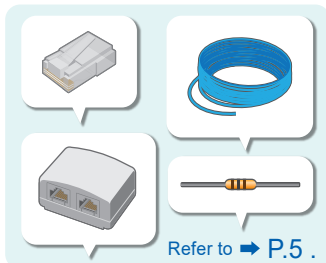

1 Preparing the required products

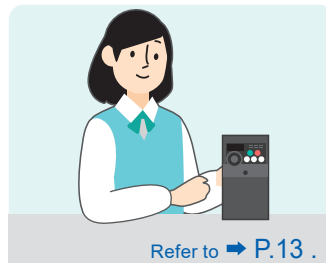

2 Setting the invertors

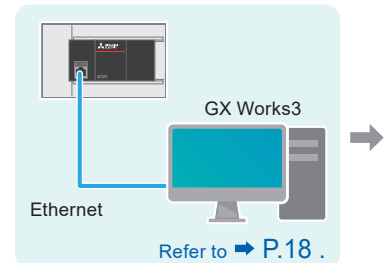

3 Setting the programmable controller and creating communication test programs

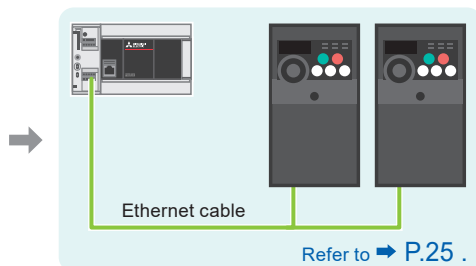

4 Checking the communication status

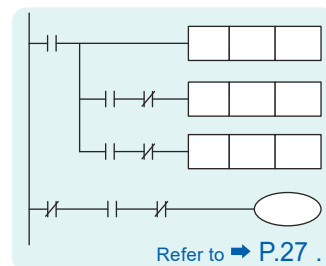

5 Example programs and checking the operation

1.2 Required Products

In this manual, two inverters (FR-D700) are connected to the FX5 CPU module.

FX5 CPU module



Personal computer



GX Works3



Ethernet cable



- 10BASE-T
Shielded twisted pair (STP) cable or category 3, 4, or 5 of unshielded twisted pair (UTP) cable

Terminal block

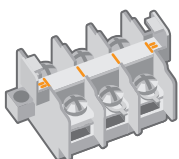

Terminating resistor 100 Ω, 1/2 W



(Brown, Black, Brown, Gold)

Distributor × 2

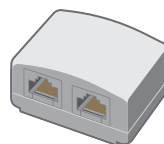

<BMJ-8-28N>
There is no internal connection of pins 2 and 8.

Inverter (FR-D700) × 2

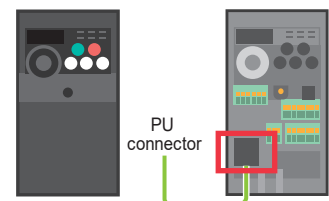

Remove the front covers of the inverters to connect the cables to the PU connectors.

1

PREPARATION

2

INVERTER SETTINGS

3

PROGRAMMABLE CONTROLLER SETTINGS

4

CHECKING COMMUNICATION STATUS

5

EXAMPLE PROGRAMS

6

TROUBLESHOOTING

APPENDIX

1. PREPARATION

Preparatory Steps

Required Products

System Configuration

Wiring

Connecting a Terminating Resistor

1

PREPARATION

2

INVERTER
SETTINGS

3

PROGRAMMABLE
CONTROLLER SETTINGS

4

CHECKING
COMMUNICATION STATUS

5

EXAMPLE
PROGRAMS

6

TROUBLESHOOTING

APPENDIX

The following items are required for making a LAN cable.

▶ Ethernet cable

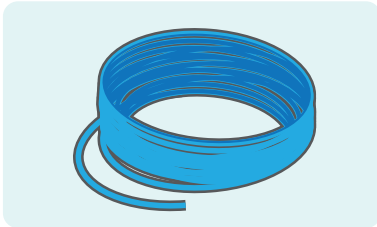

- Cable type: 10BASE-T cable (category 3, 4, or 5)
- Connection specifications: Straight type

▶ RJ45 connector (modular plug)

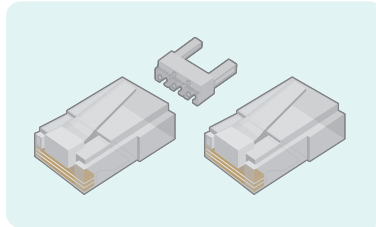

- Using a modular plug with a load bar and clip breakage prevention is recommended.

▶ Modular cover

Optional

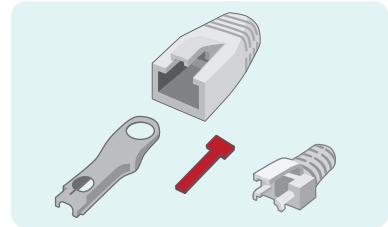

- Using a pre-attached type modular cover is recommended.

Tools

▶ Crimping tool

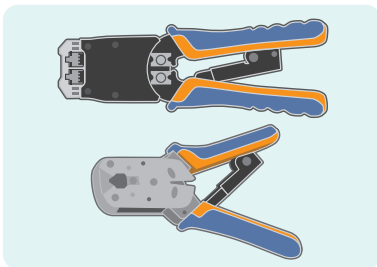

Used to crimp an RJ45 connector.

▶ Wire stripper

Optional

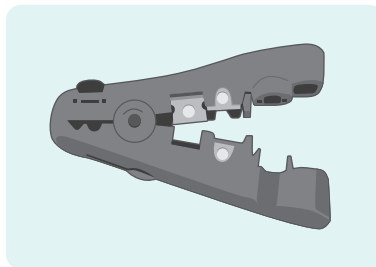

Used to strip cable jackets when connecting the LAN cables. Wiring time can be reduced by using this tool. It can be substituted with a cutter or a pair of scissors.

▶ LAN cable tester

Optional



Used to check disconnection of the self-made LAN cable. Using a separator type is recommended.

1. PREPARATION

Preparatory Steps

Required Products

System Configuration

Wiring

Connecting a Terminating Resistor

1

PREPARATION

2

INVERTER SETTINGS

3

PROGRAMMABLE CONTROLLER SETTINGS

4

CHECKING COMMUNICATION STATUS

5

EXAMPLE PROGRAMS

6

TROUBLESHOOTING

APPENDIX

1.3 System Configuration

This section describes the system configuration in which two inverters (FR-D700) are connected to the FX5 CPU module.

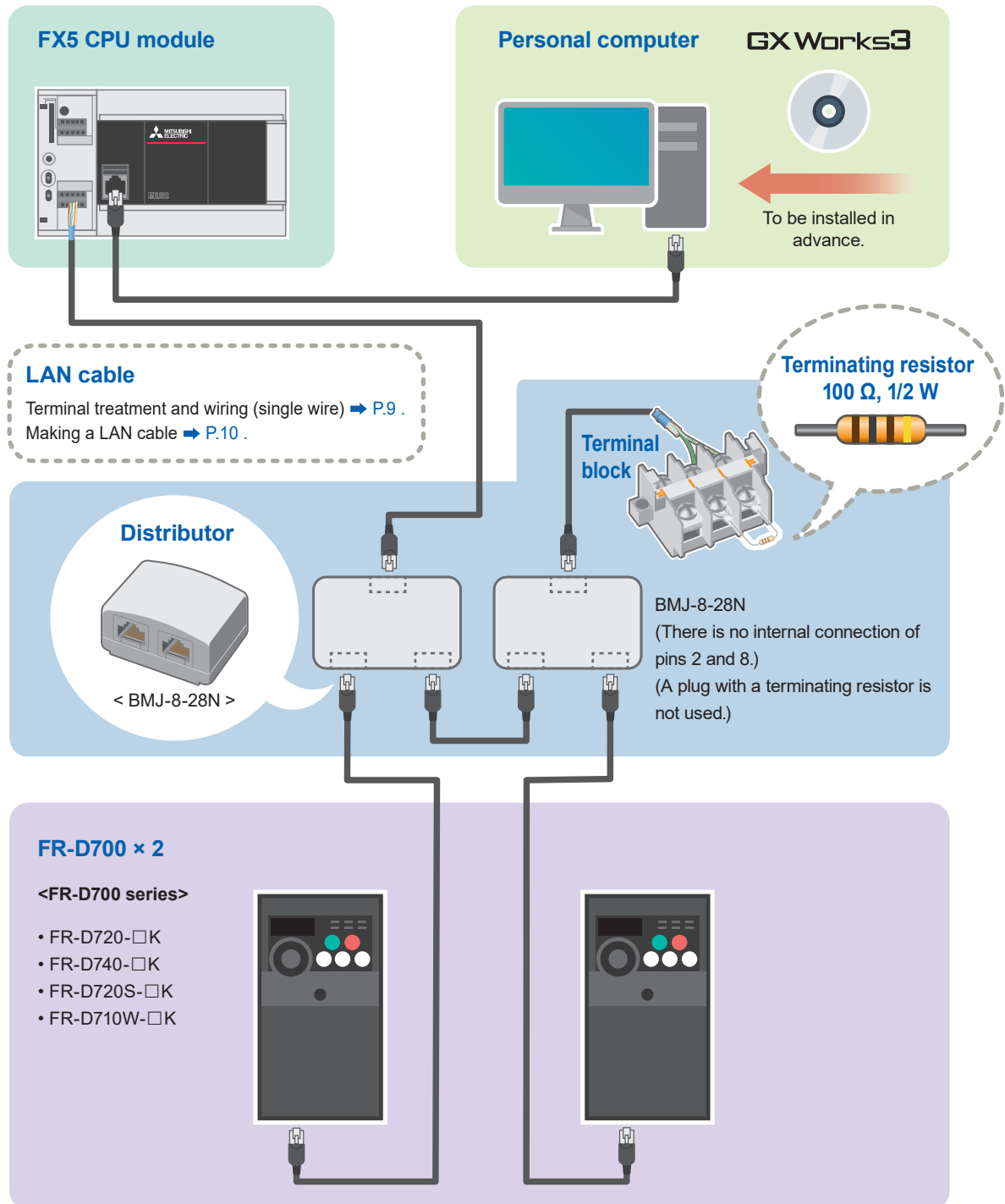

For the power supply wiring of FR-D700 series, refer to

➔ Section 2.1 Wiring in the FR-D700 INSTRUCTION MANUAL (Applied) (IB(NA)-0600366 ENG).

For the power supply wiring of the FX5 CPU module, refer to

➔ Section 13.4 Power Supply Wiring in the MELSEC iQ-F FX5S/FX5UJ/FX5U/FX5UC User's Manual (Hardware) (SH-082452ENG).

1. PREPARATION

Preparatory Steps

Required Products

System Configuration

Wiring

Connecting a
Terminating Resistor

1

PREPARATION

2

INVERTER
SETTINGS

3

PROGRAMMABLE
CONTROLLER SETTINGS

4

CHECKING
COMMUNICATION STATUS

5

EXAMPLE
PROGRAMS

6

TROUBLESHOOTING

APPENDIX

1.4 Wiring

This section describes the procedures for wiring and terminal treatment of the cables.

▶ Wiring LAN cables (RS-485 port side)

Connect a single wire to a built-in RS-485 port on the terminal block.

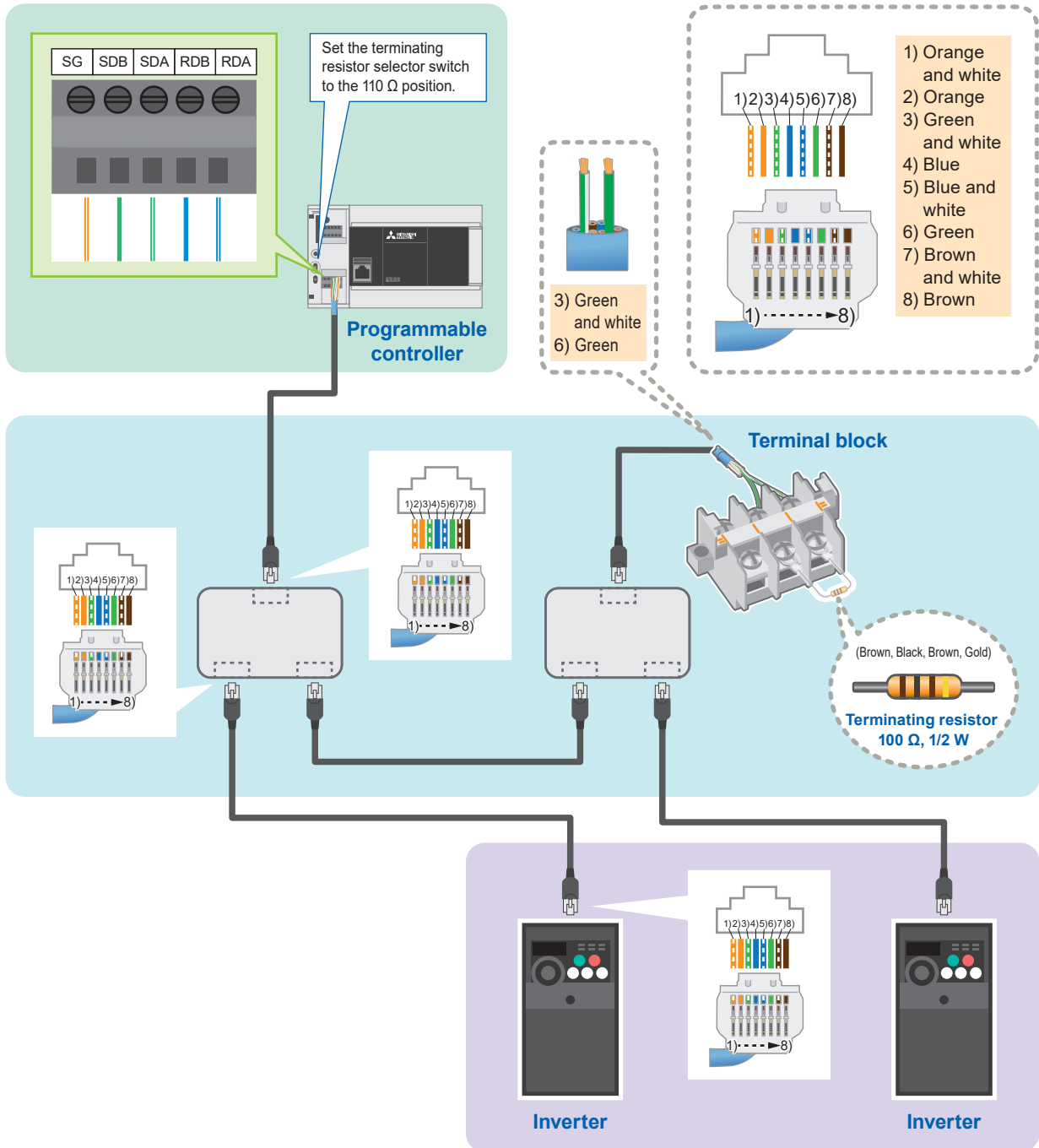

1. PREPARATION

Preparatory Steps

Required Products

System Configuration

Wiring

Connecting a Terminating Resistor

1.4.1 Cable terminal treatment and wiring (single wire)

Strip the cable jacket, and perform cable terminal treatment for a stranded or solid wire. Alternatively, use a bar terminal with an insulation sleeve.

Terminal treatment for the stranded or solid wire

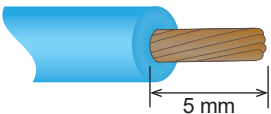
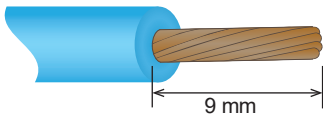
Cable jacket stripping length	
FX5U CPU module built-in RS-485 port	FX5UC CPU module built-in RS-485 port
	

Using a bar terminals with an insulation sleeve

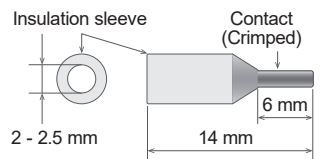
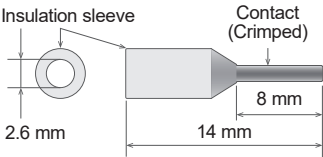
	Dimensions	Model	Crimping tool
FX5U CPU module built-in RS-485 port		AI 0.5-6 WH	CRIMPFOX 6 CRIMPFOX 6T-F
FX5UC CPU module built-in RS-485 port		AI 0.5-8 WH	

Screwdriver for the RS-485 terminal block

Use a commercially available small screwdriver with a straight edge, which does not spread at the end, as shown in the figure on the right.

<Reference>

Manufacturer	Model
PHOENIX CONTACT Co., Ltd.	SZS0.4 × 2.5

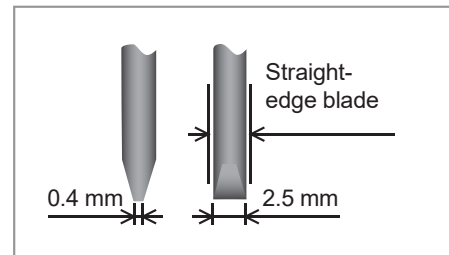

1. PREPARATION

Preparatory Steps

Required Products

System Configuration

Wiring

Connecting a Terminating Resistor

1

PREPARATION

2

INVERTER SETTINGS

3

PROGRAMMABLE CONTROLLER SETTINGS

4

CHECKING COMMUNICATION STATUS

5

EXAMPLE PROGRAMS

6

TROUBLESHOOTING

APPENDIX

1.4.2 Making a LAN cable

Follow the procedure below when making a LAN cable.

Step 1. Cutting a cable

Cut the cable to a required length.



Step 2. Attaching a modular cover (temporary)

When using a pre-attached type modular cover, attach it to the cable.

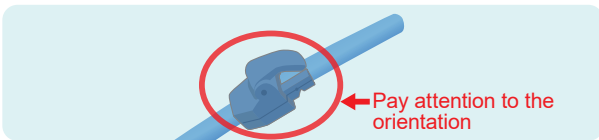

Step 3. Stripping a cable jacket

Strip the cable jacket on both ends using a cable stripper.

It can be substituted with a cutter or a pair of scissors. When using either one of them, be careful not to damage core wires.

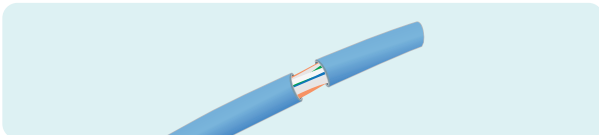
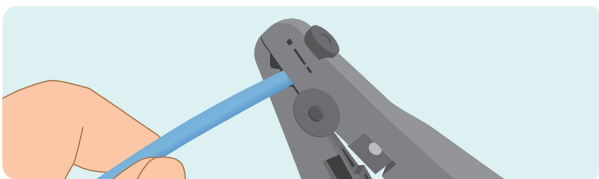

Cut out the cross separator in the cable if applicable.

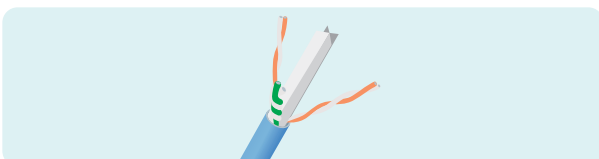

Step 4. Rearranging core wires

Rearrange the core wires in accordance with the type of a LAN cable to be made.

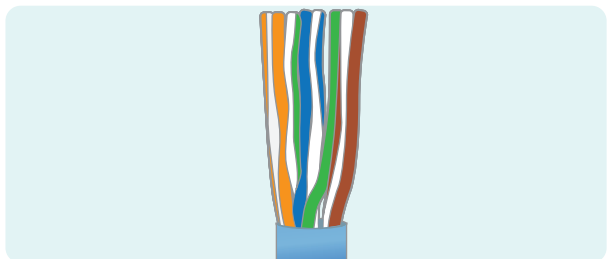

■ Front view of the connector (insertion side)

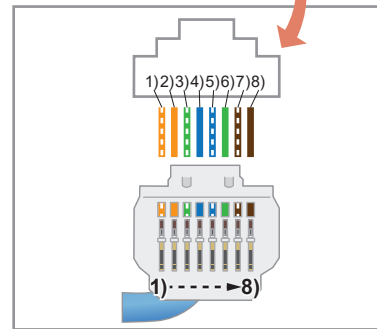
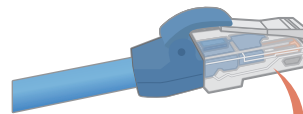

- 1) Orange and white
- 2) Orange
- 3) Green and white
- 4) Blue
- 5) Blue and white
- 6) Green
- 7) Brown and white
- 8) Brown



To the next page

1. PREPARATION

Preparatory Steps

Required Products

System Configuration

Wiring

Connecting a Terminating Resistor

From the previous page

Step 5. Cutting core wires

With a load bar

1. Insert each core wire through the slot of the load bar.

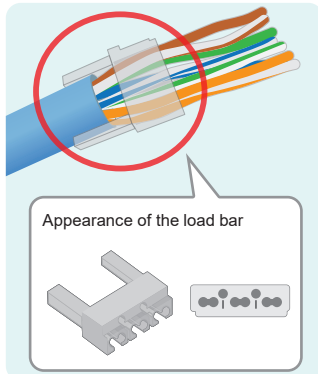

2. Cut the core wires at the edge of the load bar.

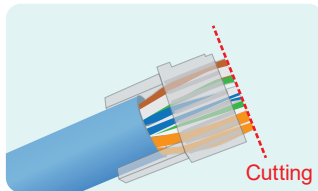

3. Insert the load bar into a connector.

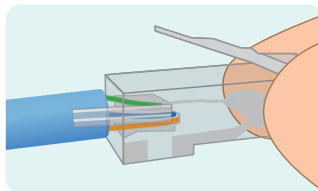

4. Make sure that the load bar is fully inserted to reach the end of the connector.

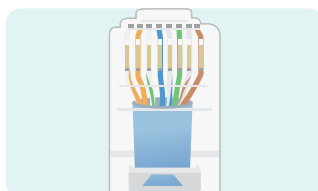

Without a load bar

1. Arrange the core wires, and cut them to approximately 1.5 cm.

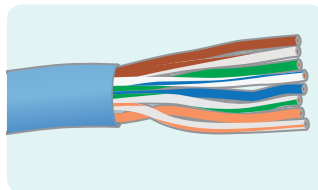

2. Insert the core wires into a connector.

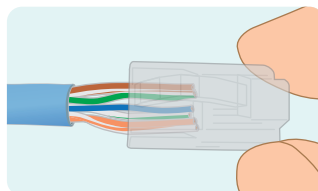

3. Check that the core wires reach the end of the connector.

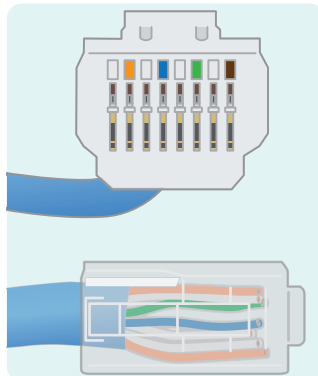

Step 6. Crimping the connector using a crimping tool

Crimp the connector onto the cable using the crimping tool.

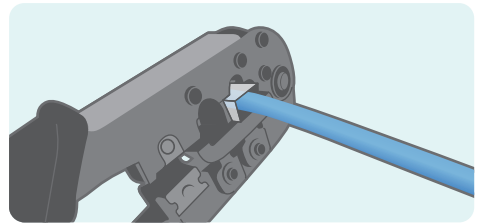

Step 7. Checking the self-made LAN cable

Check that there is no improper connection or disconnection of the self-made LAN cable.

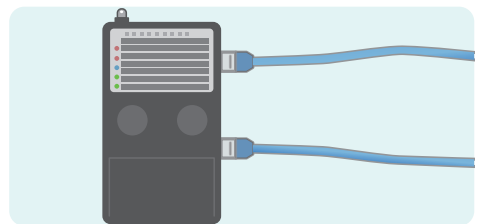

Step 8. Adjusting and fixing the modular cover (When the pre-attached type modular cover is used)

[Before]

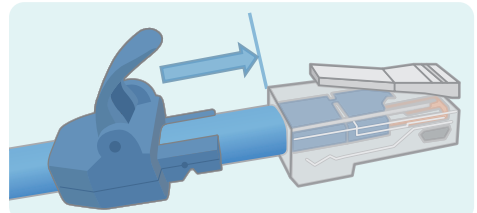

[After]

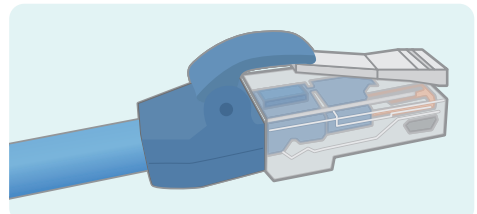

1

PREPARATION

2

INVERTER SETTINGS

3

PROGRAMMABLE CONTROLLER SETTINGS

4

CHECKING COMMUNICATION STATUS

5

EXAMPLE PROGRAMS

6

TROUBLESHOOTING

APPENDIX

1. PREPARATION

Preparatory Steps

Required Products

System Configuration

Wiring

Connecting a Terminating Resistor

1

PREPARATION

2

INVERTER
SETTINGS

3

PROGRAMMABLE
CONTROLLER SETTINGS

4

CHECKING
COMMUNICATION STATUS

5

EXAMPLE
PROGRAMS

6

TROUBLESHOOTING

APPENDIX

1.5 Connecting a Terminating Resistor

Connect a terminating resistor of 100 Ω , 1/2 W to the farthest inverter. Connect it across pin 3 (RDA) and pin 6 (RDB) of the distributor.

The following is a typical connection example.

▶ Connecting the terminating resistor to the inverter using a terminal block

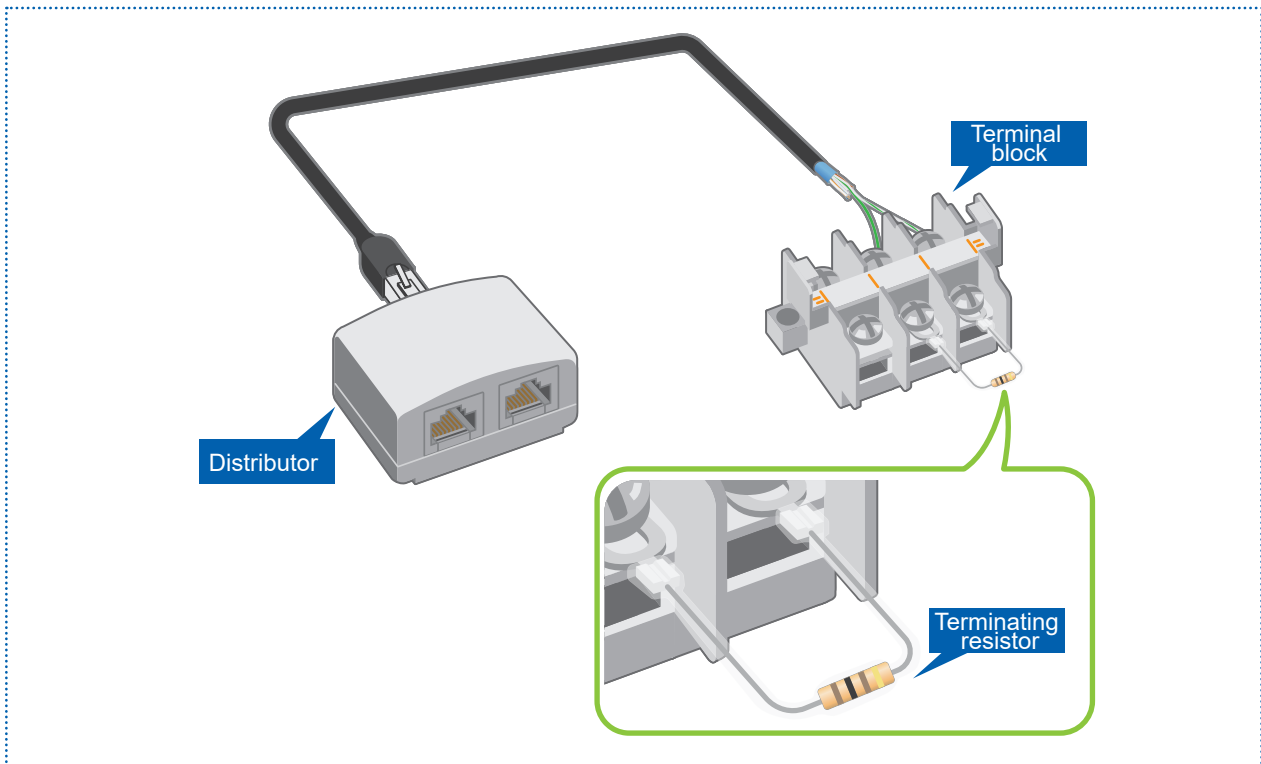

2. INVERTER SETTINGS

Names of the Parts on the Operation Panel

Parameter List

Parameter Settings

Inverter Reset

2.1 Names of the Parts on the Operation Panel

Inverter parameters can be set and checked on the operation panel. The parameters are shown on the LCD display.

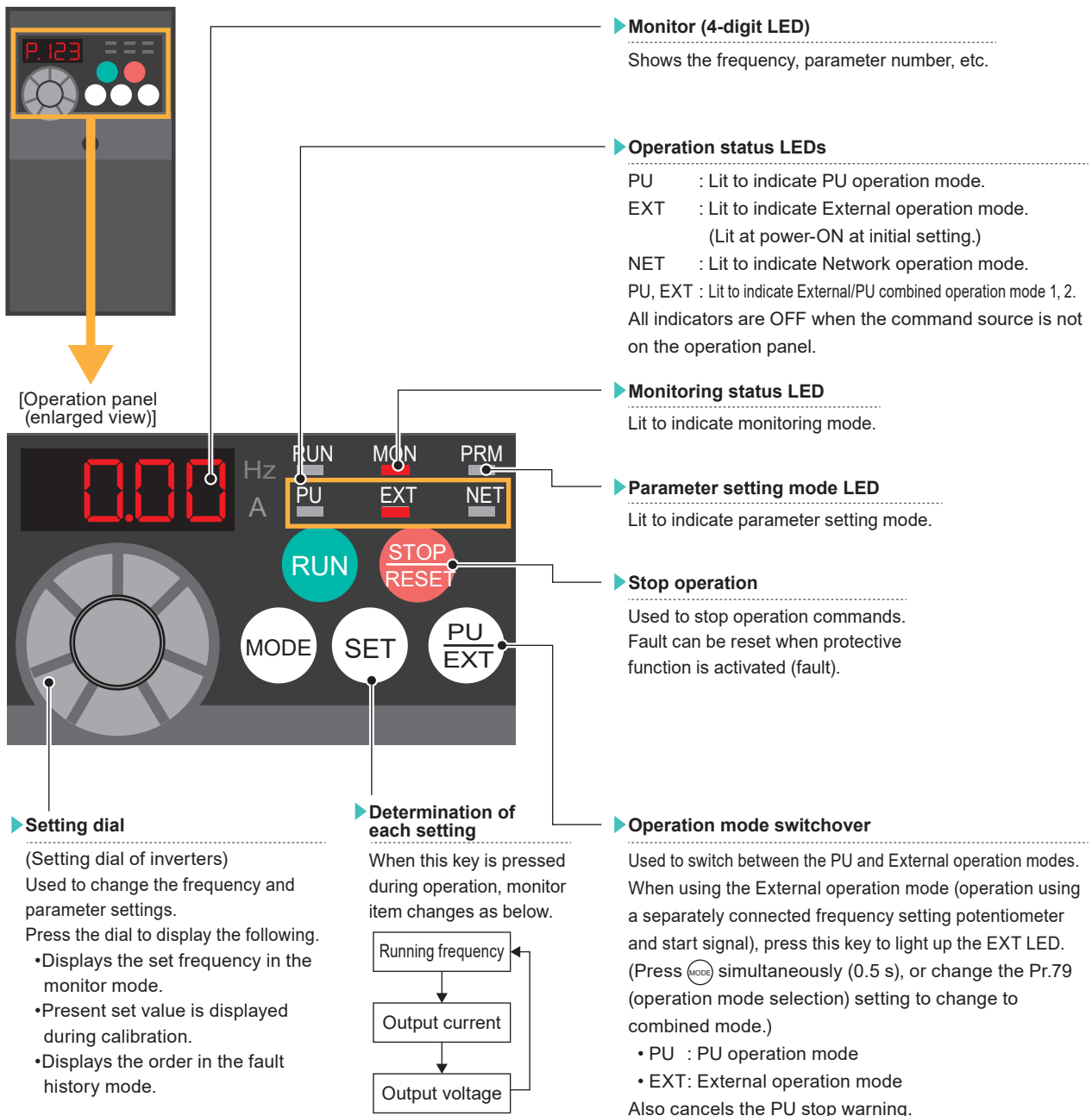

*: The operation panel cannot be removed from the inverter.

For the names of the parts on the operation panel, refer to

➔ [Section 4.1 Operation panel in the FR-D700 Instruction Manual \(Applied\) \(IB\(NA\)-0600366ENG\)](#).

2. INVERTER SETTINGS

Names of the Parts on the Operation Panel

Parameter List

Parameter Settings

Inverter Reset

1 PREPARATION

2.2 Parameter List

2.2.1 Inverter communication settings (required settings)

The following lists the parameters which are required to be set.

Description	Parameter	Name	Initial value	Setting value (for the first inverter)	Setting value (for the second inverter)	Description
Display setting	Pr.160	Extended function display selection	9999	0	0	0: Displays simple mode and extended parameters.
Communication setting	Pr.117	PU communication station number	0	0	1	Maximum 16 inverters can be connected.
	Pr.118	PU communication speed	192	192	192	48 : 4800 bps 96 : 9600 bps 192 : 19200 bps 384 : 38400 bps
	Pr.119	PU communication stop bit length	1	10	10	10: Data length: 7 bits Stop bit: 1 bit
	Pr.120	PU communication parity check	2	2	2	2: Even parity
	Pr.123	PU communication waiting time setting	9999	9999	9999	Set with communication data.
	Pr.124	PU communication CR/LF selection	1	1	1	1: CR: Provided, LF: Not provided
Operation mode setting	Pr.549	Protocol selection	0	0	0	0: Mitsubishi inverter (computer link operation) protocol
	Pr.79	Operation mode selection	0	0	0	0: At power ON, the inverter is in the External operation mode.
	Pr.340	Communication startup mode selection	0	10	10	1 : Network operation mode 10: Network operation mode (Operation mode can be changed between the PU operation mode and Network operation mode from the operation panel.)

2.2.2 Parameter settings (for adjustment and operation)

Parameter	Name	Setting value during adjustment	Initial value	Setting value (for the first and second inverters)	Description
Pr.121	Number of PU communication retries	9999	1	3 (times)	Set "9999" during adjustment, and set a value from 1 to 10 during operation.
Pr.122	PU communication check time interval	9999	0	5.0 (= 5 seconds)	Set "9999" during adjustment, and set a value in accordance with the system specification during operation. 9999 : During adjustment or when the inverters do not communicate with the programmable controller periodically 0 : When the inverters do not communicate with the programmable controller 1 to 9998: When it is necessary to monitor absence of communications for a certain time and stop the inverters while they are communicating with the programmable controller continuously. When it is necessary to stop the motor when the programmable controller mode is changed from RUN to STOP.

2 INVERTER SETTINGS

3 PROGRAMMABLE CONTROLLER SETTINGS

4 CHECKING COMMUNICATION STATUS

5 EXAMPLE PROGRAMS

6 TROUBLESHOOTING

APPENDIX

2. INVERTER SETTINGS

Names of the Parts on the Operation Panel

Parameter List

Parameter Settings

Inverter Reset

2.3 Parameter Settings

This section describes the parameter settings on the inverters.

Set Pr.160 (extended function display selection) to "0" to enable the parameter so that relevant parameters are displayed.

▶ Presetting for the inverter communication settings

1. Enabling the following modes for setting the parameters on the operation panel

Press **PU/EXT** and switch to PU operation mode. (The PU LED is ON.)

Press **MODE** and switch to parameter setting mode. (The PRM LED is ON.)

2. Enabling the parameter settings

Set the following parameter before the communication parameters are set. indicates the setting dial.

Turn and set to P.160 (Pr.160).

Press **SET**. The initial value "9999" is displayed.

Turn and set to 0.

Press **SET**.

***:** The parameter number and the setting value are displayed alternately after the parameter setting is completed. When the value is not changed, this will not happen.

2. INVERTER SETTINGS

Names of the Parts on the Operation Panel

Parameter List

Parameter Settings

Inverter Reset

1 PREPARATION

2 INVERTER SETTINGS

3 PROGRAMMABLE CONTROLLER SETTINGS

4 CHECKING COMMUNICATION STATUS

5 EXAMPLE PROGRAMS

6 TROUBLESHOOTING

APPENDIX

The following describes the settings of the required parameters: Pr.117 (PU communication station number) and Pr.340 (communication startup mode selection).

▶ Communication parameter settings

■ Pr.117 (PU communication station number) setting



Turn and set to P.117 (Pr.117).

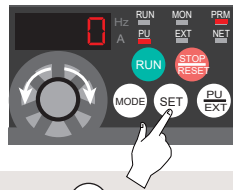

Press . The initial value "0" is displayed.

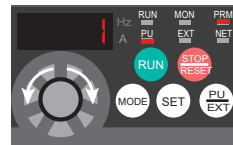

Turn and set to a predetermined inverter station number.

- First inverter: 0
- Second inverter: 1

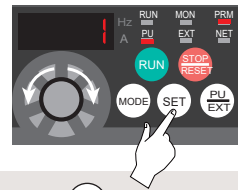

Press .



*: The parameter number and the setting value are displayed alternately after the parameter setting is completed. When the value is not changed, this will not happen.

■ Pr.340 (communication startup mode selection) setting



Turn and set to P.340 (Pr.340).

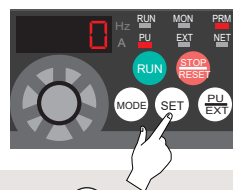

Press . The initial value "0" is displayed.



Turn and set to 10.

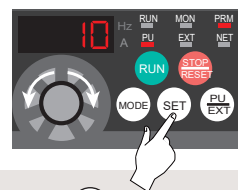

Press .



*: The parameter number and the setting value are displayed alternately after the parameter setting is completed. When the value is not changed, this will not happen.

Pr.117 (PU communication station number) and Pr.340 (communication startup mode selection) have been set. Repeat the same procedure for setting other required parameters (P.14).

▶ Enabling the communication settings

Power OFF and ON the inverter after all the communication parameters are set.



Check that the NET LED is ON and the NET operation mode is enabled.

Point

Power OFF and ON the inverter every time after the initial setting of each parameter is completed. After the setting values of the communication parameters are changed, reset the inverter to reflect new values. → P.17

2. INVERTER SETTINGS

Names of the Parts on the Operation Panel

Parameter List

Parameter Settings

Inverter Reset

2.4 Inverter Reset

To reset the inverter, turn OFF the power, and then ON again after the LEDs on the operation panel turn OFF. The inverter will restart about 1 second after reset.

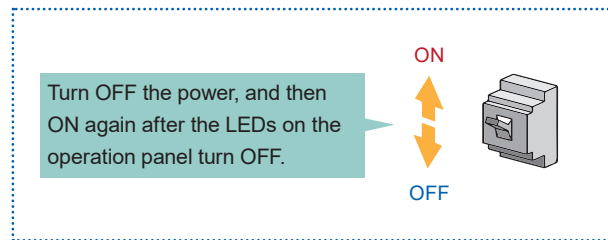

*: Note that the internal thermal integrated value of the electronic thermal relay function and the number of retries are cleared (erased) by resetting the inverter.

Point

- Make sure to turn OFF the start signal before resetting an inverter fault. Resetting the inverter fault with the start signal ON restarts the motor suddenly.
- The inverter reset can be executed in the program. ➔ [P.20](#)

3. PROGRAMMABLE CONTROLLER SETTINGS

Parameter Settings

Communication
Test Programs

Communication
Settings

Writing Data to the
Programmable Controller

1 PREPARATION

Connect the personal computer to the programmable controller, and write the necessary parameters to the programmable controller.

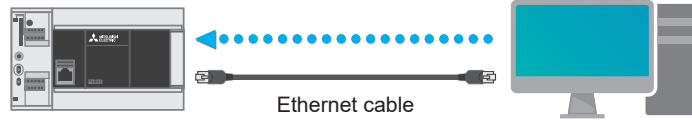

*: Parameters can be set regardless of the inverter connection status.

2 INVERTER SETTINGS

3.1 Parameter Settings Using GX Works3 (Required Settings)

3

1 Start GX Works3.

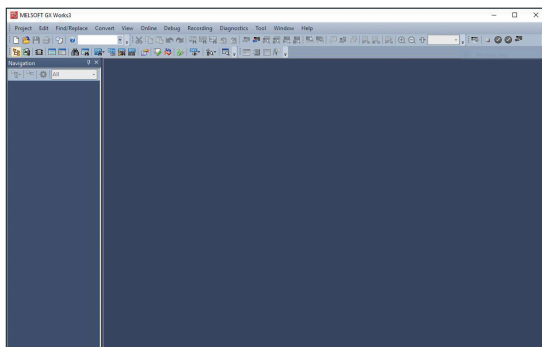

3 On the displayed window, set the following, and click the **OK** button.

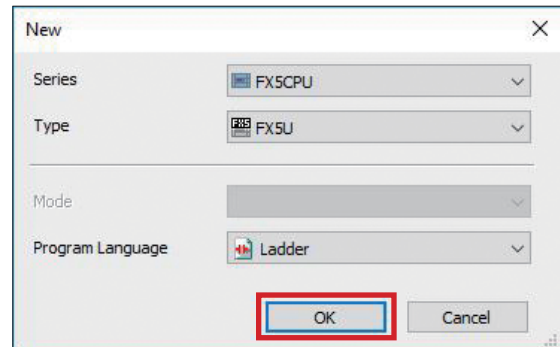

PROGRAMMABLE CONTROLLER SETTINGS

4 CHECKING COMMUNICATION STATUS

2 Select [Project] ⇒ [New].

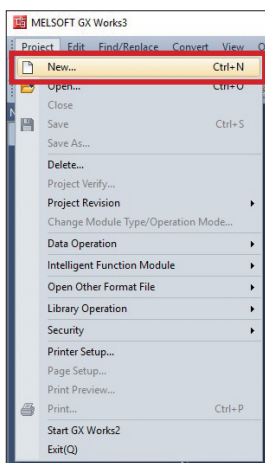

4 In the "Navigation" window, select [Parameter] ⇒ [FX5UCPU] ⇒ [Module Parameter] ⇒ [485 Serial Port].

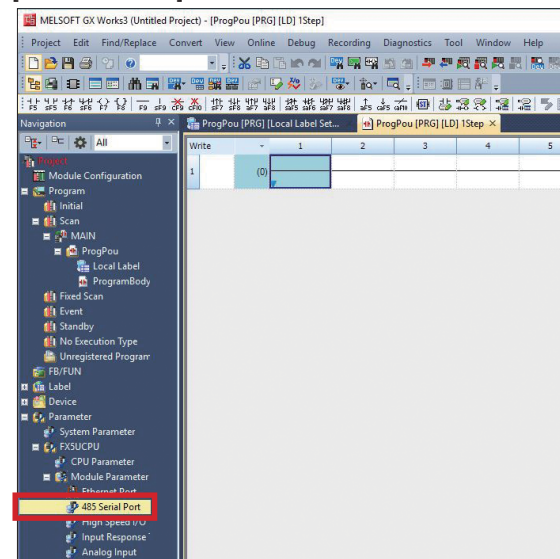

5 EXAMPLE PROGRAMS

6 TROUBLESHOOTING

APPENDIX

3. PROGRAMMABLE CONTROLLER SETTINGS

Parameter Settings

Communication Test Programs

Communication Settings

Writing Data to the Programmable Controller

- 5** Select [Inverter Communication] for the communication protocol type to display the following window. In the "Advanced Settings" field, set parameters for the inverter.

Basic settings

Item	Setting
Communication Protocol Type	Set communication protocol type.
Communication Protocol Type	Inverter Communication
Advanced Settings	Set detailed setting.
Data Length	7bit
Parity Bit	Even
Stop Bit	1bit
Baud Rate	19,200bps



Point

Set the same parameters for the programmable controller and inverters.

Basic settings

Item	Setting
Communication Protocol Type	Set communication protocol type.
Communication Protocol Type	Inverter Communication
Advanced Settings	Set detailed setting.
Data Length	7bit
Parity Bit	Even
Stop Bit	1bit
Baud Rate	19,200bps

Parameter No.	Parameter item	Description	Setting value
Pr.118	PU communication speed	19200 bps	192
Pr.119	PU communication stop bit length	Data length: 7 bits Stop bit: 1 bit	10
Pr.120	PU communication parity check	Even	2

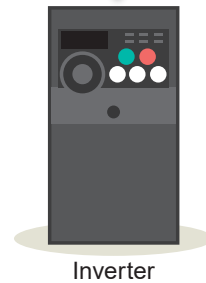
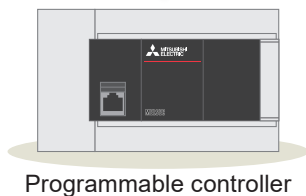

- 6** After the parameters are set, click the **Apply** button.

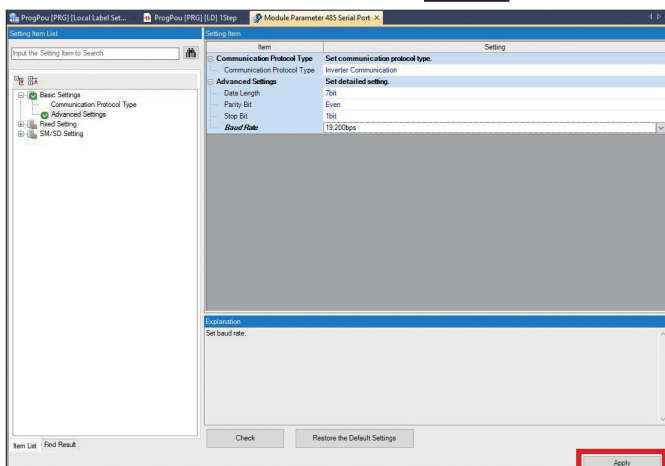

*: In this manual, the parameters set above are written to the programmable controller together with communication test programs, which will be created in the next section.

1 PREPARATION

2 INVERTER SETTINGS

3 PROGRAMMABLE CONTROLLER SETTINGS

4 CHECKING COMMUNICATION STATUS

5 EXAMPLE PROGRAMS

6 TROUBLESHOOTING

APPENDIX

3. PROGRAMMABLE CONTROLLER SETTINGS

Parameter Settings

Communication
Test Programs

Communication
Settings

Writing Data to the
Programmable Controller

1 PREPARATION

2 INVERTER
SETTINGS

3 PROGRAMMABLE
CONTROLLER SETTINGS

4 CHECKING
COMMUNICATION STATUS

5 EXAMPLE
PROGRAMS

6 TROUBLESHOOTING

APPENDIX

3.2 Communication Test Programs

These programs reset both inverters by sending the inverter reset command and confirm the following conditions.

- The system has been properly wired.
- The parameters of the programmable controller and inverters have been properly set.

▶ Inverter reset circuit of the first inverter (station number 0)

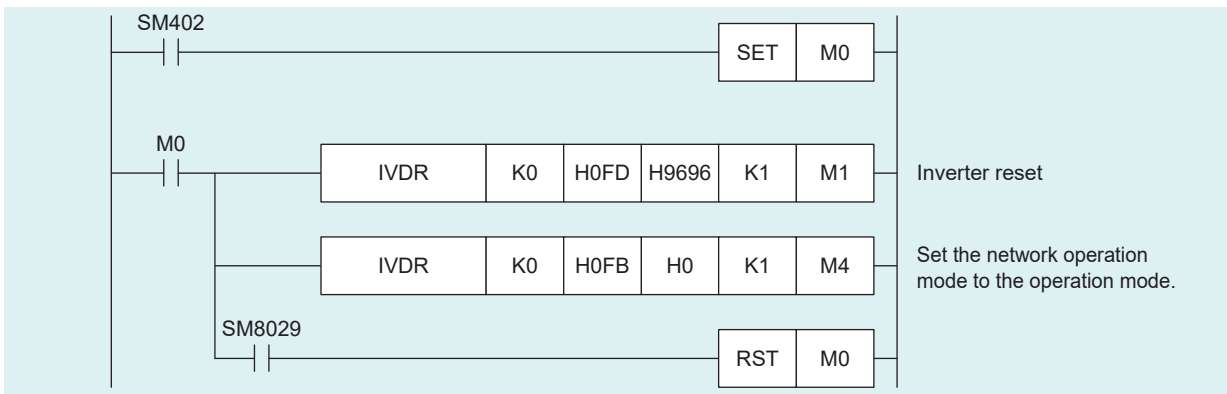

▶ Inverter reset circuit of the second inverter (station number 1)

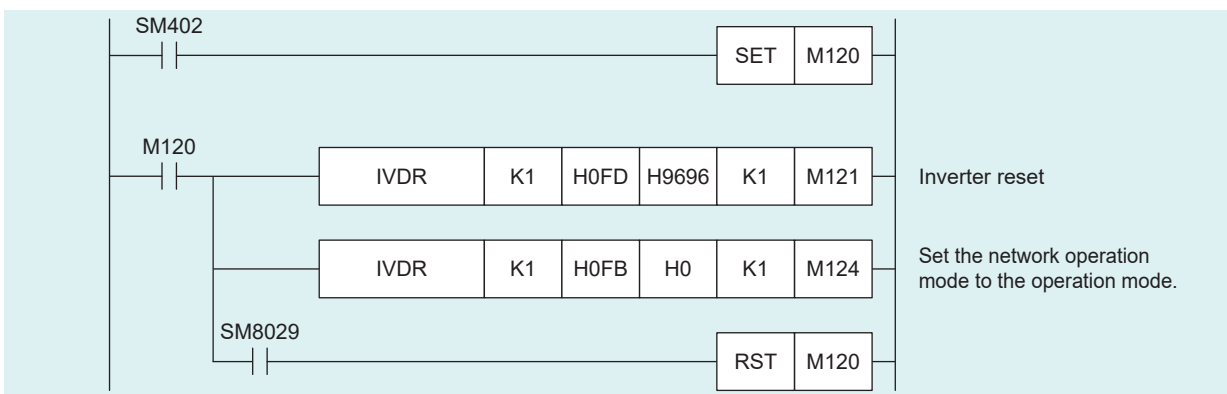

3. PROGRAMMABLE CONTROLLER SETTINGS

Parameter Settings

Communication Test Programs

Communication Settings

Writing Data to the Programmable Controller

1 PREPARATION

Connect the personal computer to the programmable controller.
Perform the communication test before writing the parameters and programs to the programmable controller.

▶ System configuration example

Direct connection to the Ethernet ports

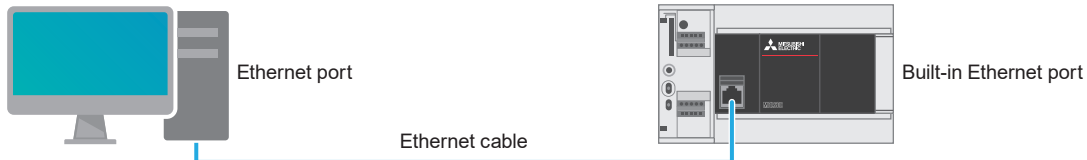

2 INVERTER SETTINGS

3.3 Communication Settings Using GX Works3

▶ Communication test procedure

1 Select [Online] ⇒ [Current Connection Destination].

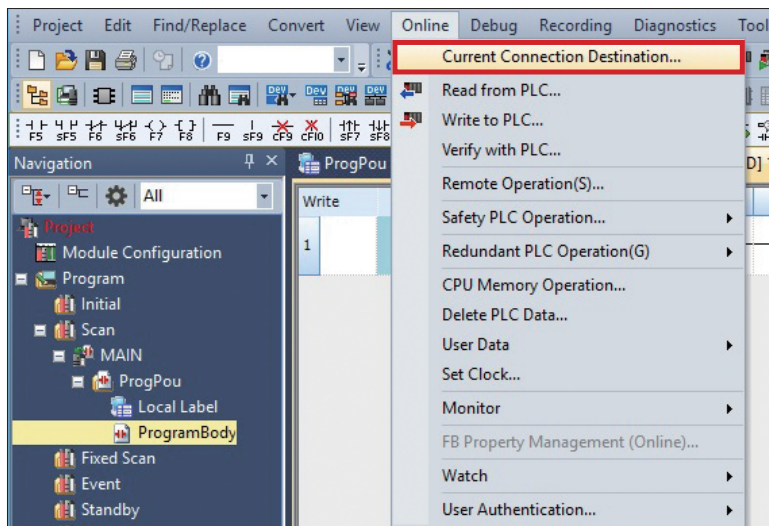

3 PROGRAMMABLE CONTROLLER SETTINGS

2 Select a connection method.

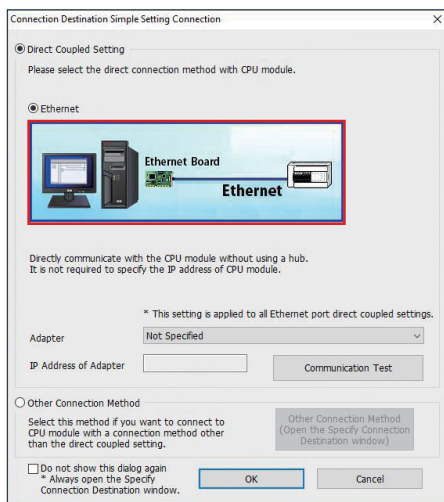

4 CHECKING COMMUNICATION STATUS

5 EXAMPLE PROGRAMS

6 TROUBLESHOOTING

APPENDIX

3. PROGRAMMABLE CONTROLLER SETTINGS

Parameter Settings

Communication
Test Programs

Communication
Settings

Writing Data to the
Programmable Controller

1 PREPARATION

2 INVERTER
SETTINGS

3 PROGRAMMABLE
CONTROLLER SETTINGS

4 CHECKING
COMMUNICATION STATUS

5 EXAMPLE
PROGRAMS

6 TROUBLESHOOTING

APPENDIX

- 3** An Ethernet adapter of the personal computer, which is used when the programmable controller is directly connected to an Ethernet port, can be specified.
When "Not Specified" is set in "Adapter", select an adapter to be used from the drop-down list.

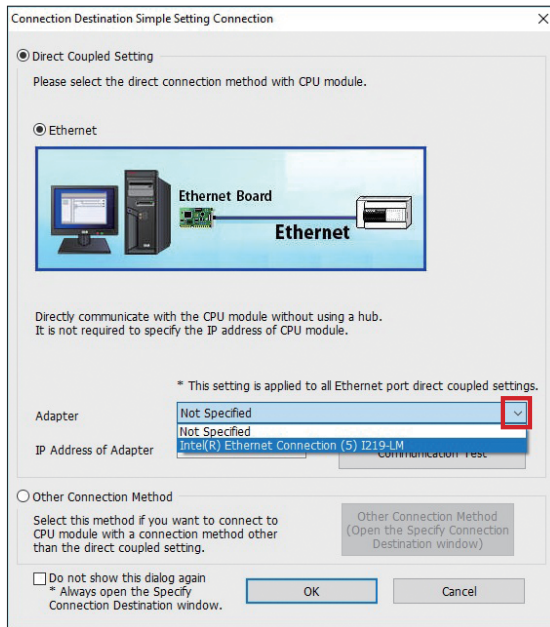

- 4** After the adapter is selected, click the [Communication Test] button.

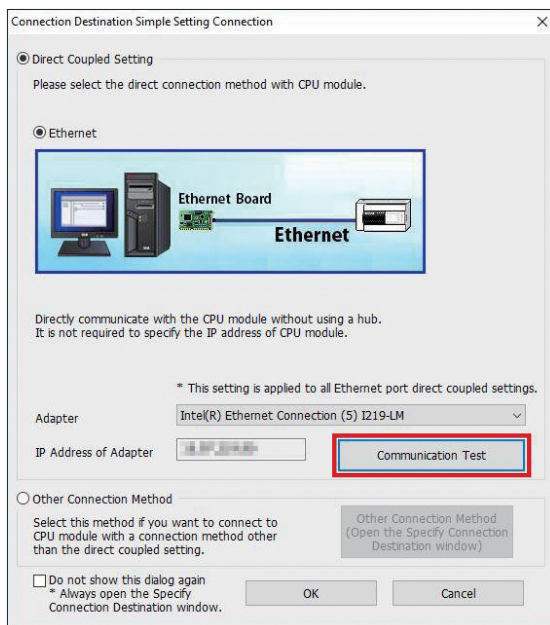

- 5** When the following window appears, click the **OK** button.

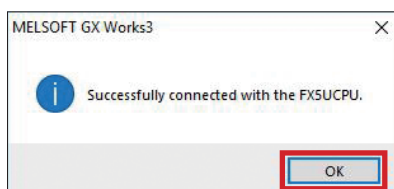

3. PROGRAMMABLE CONTROLLER SETTINGS

Parameter Settings | Communication Test Programs | Communication Settings | Writing Data to the Programmable Controller

3.4 Writing Data to the Programmable Controller

The following procedure must be completed before the parameters and programs are written to the programmable controller.

- 1 Select [Convert] → [Rebuild All].

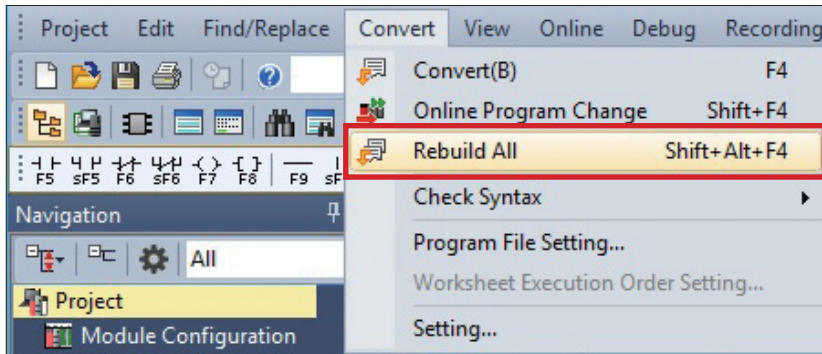

- 2 Click the **OK** button.

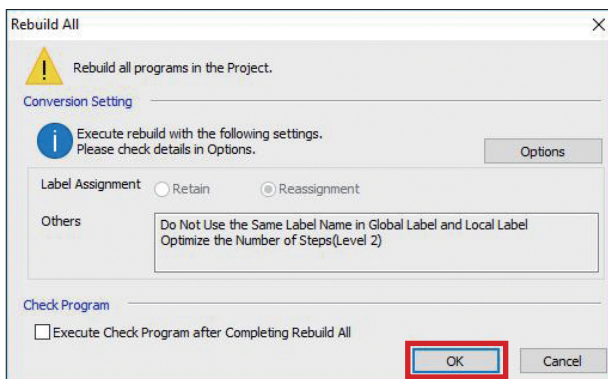

The programs are transferred to the programmable controller.

- 3 Select [Online] → [Write to PLC].

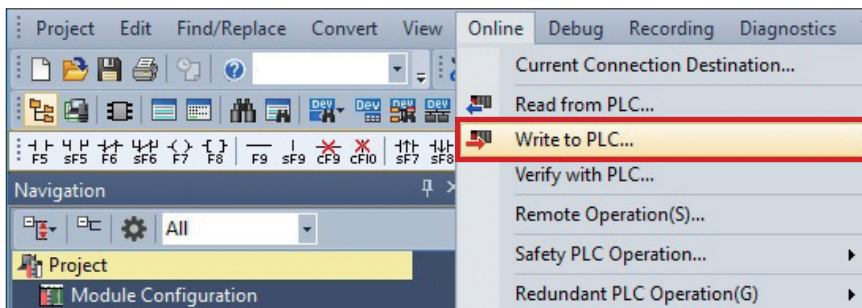

3. PROGRAMMABLE CONTROLLER SETTINGS

Parameter Settings

Communication
Test Programs

Communication
Settings

Writing Data to the
Programmable Controller

1 PREPARATION

2 INVERTER
SETTINGS

3 PROGRAMMABLE
CONTROLLER SETTINGS

4 CHECKING
COMMUNICATION STATUS

5 EXAMPLE
PROGRAMS

6 TROUBLESHOOTING

APPENDIX

4 Click the [Parameter + Program] button, and click the **Execute** button.

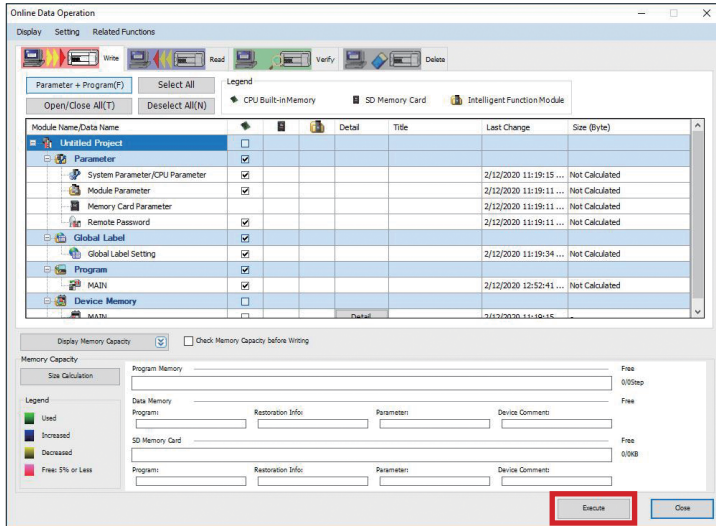

5 Click the **Yes** button.

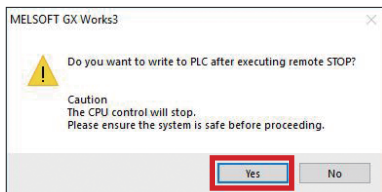

6 Click the **Yes to all** button.

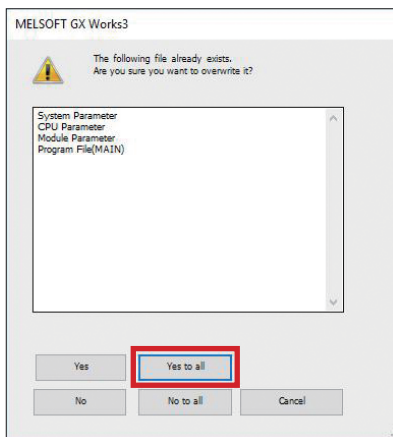

7 Click the **Yes** button.

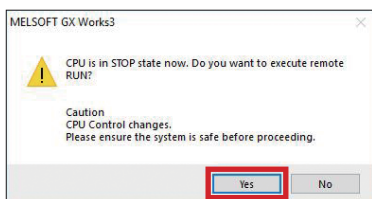

After the parameters and programs are written to the programmable controller, power OFF and ON the programmable controller (or reset the CPU module).

4. CHECKING COMMUNICATION STATUS

Connect the inverters to the programmable controller, and check the operation.

After the programmable controller is switched from STOP to RUN, it resets both inverters by sending the inverter reset command to these inverters.

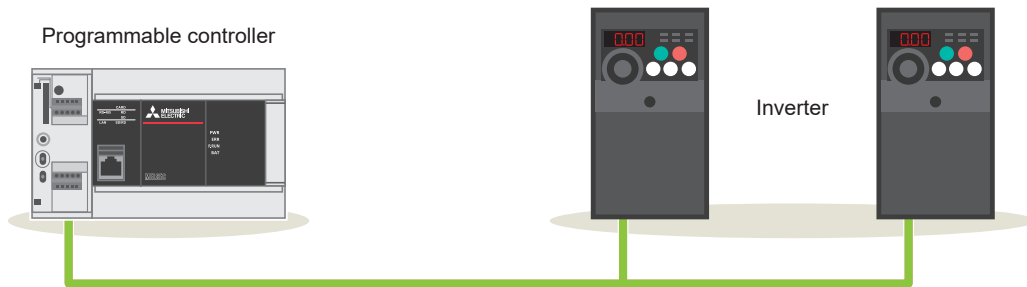

*: Operations of the programmable controller and inverters can be checked regardless of the connection status of the personal computer.

▶ Normal operation

A successful inverter reset can be checked as follows.

Checking with a sound → The inverters make a clicking sound.

Checking with 4-digit LED indication → The LEDs turn OFF for a moment. After the first inverter is reset, the second inverter will be reset.

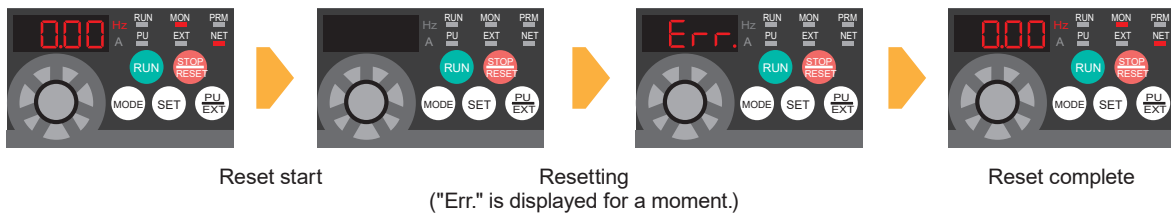

After checking the above, go to → [the next page](#).

▶ Faulty operation

If the programmable controller and the inverters are connected incorrectly or the parameters are set incorrectly, a faulty inverter reset can be checked as follows.

Checking with a sound → The inverters make no sound.

Checking with 4-digit LED indication → The LEDs remain the same.

Check the wiring and the parameter settings.

- Wiring → [P.8](#)
- Parameter settings for the programmable controller → [P.18](#)
- Parameter settings for the inverters → [P.14](#)
- Inverter reset (communication test program) → [P.20](#)

5. EXAMPLE PROGRAMS

Operation

Operation Check

5.1 Operation

This section describes the program used for operation stop (X0), forward rotation (X1), and reverse rotation (X2) to control operations of the station number 0 (first inverter).

The frequency setting can be changed by changing the value set in D11.

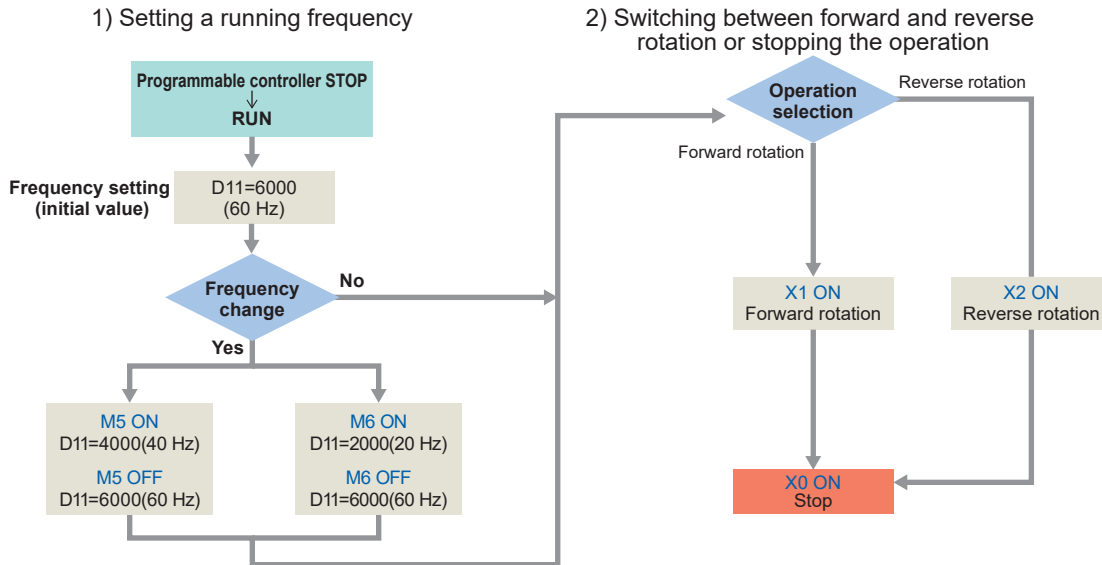

Inverter operation control

The following example program use the IVMC instruction. The IVMC instruction simplifies the programs and reduces communication time.

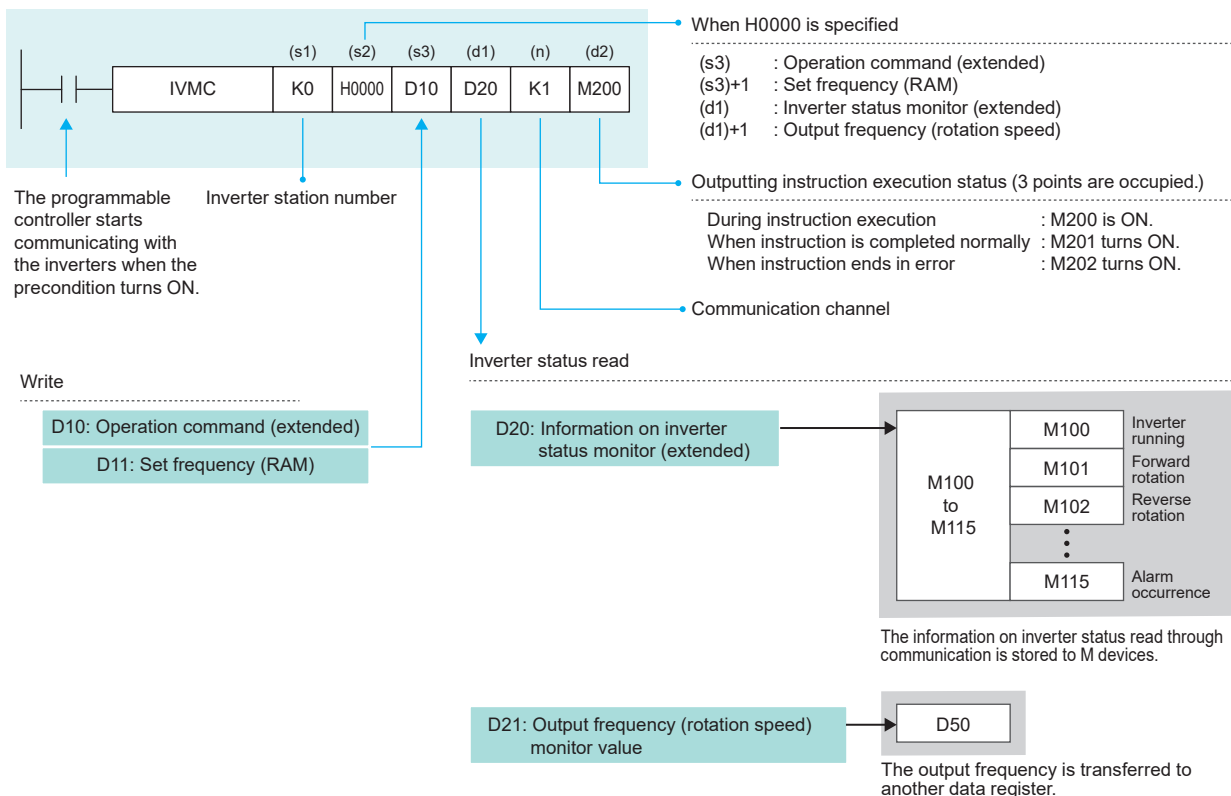

5. EXAMPLE PROGRAMS

Operation

Operation Check

5.1.1 Example programs

This program is used for operation stop (X0), forward rotation (X1), and reverse rotation (X2) to control operations of the inverter. The frequency setting can be changed by changing the value set in D11.

Ladder diagram for the station number 0 (first inverter)

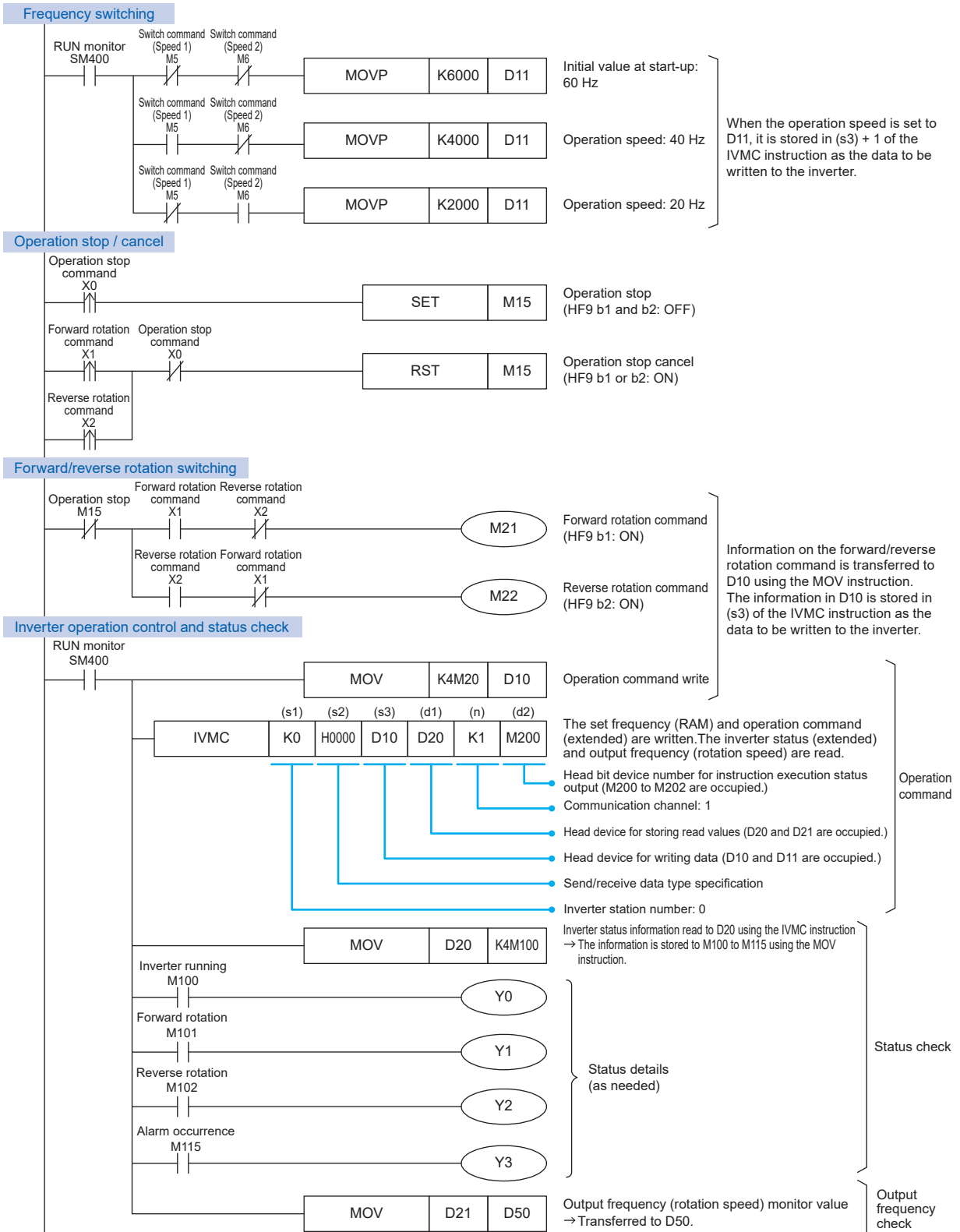

1 PREPARATION

2 INVERTER SETTINGS

3 PROGRAMMABLE CONTROLLER SETTINGS

4 CHECKING COMMUNICATION STATUS

5 EXAMPLE PROGRAMS

6 TROUBLESHOOTING

APPENDIX

5. EXAMPLE PROGRAMS

Operation

Operation Check

1 PREPARATION

2 INVERTER SETTINGS

3 PROGRAMMABLE CONTROLLER SETTINGS

4 CHECKING COMMUNICATION STATUS

5 EXAMPLE PROGRAMS

6 TROUBLESHOOTING

APPENDIX

This program is used for operation stop (X10), forward rotation (X11), and reverse rotation (X12) to control operations of the inverter. The frequency setting can be changed by changing a value set in D31.

Ladder diagram for the station number 1 (second inverter)

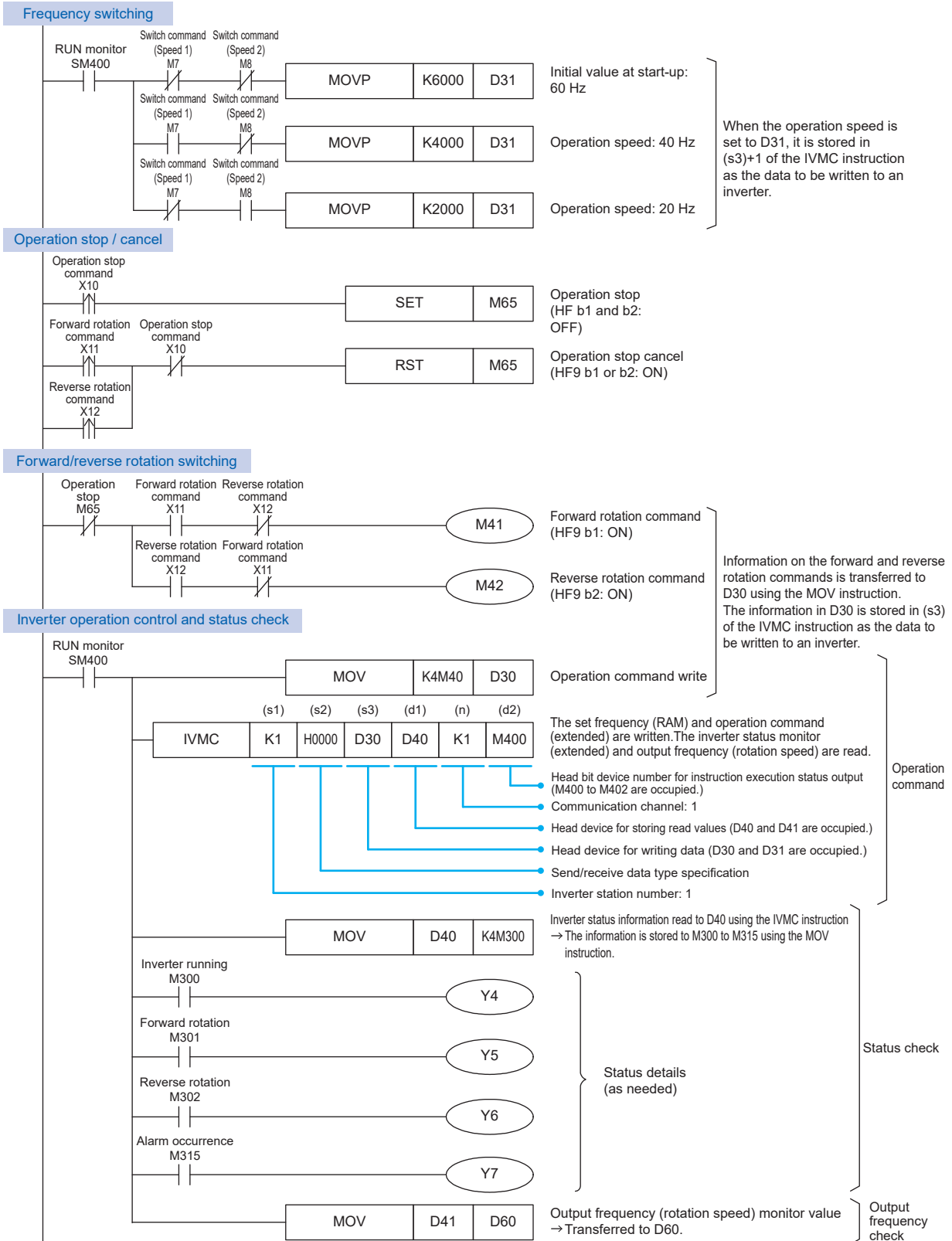

5. EXAMPLE PROGRAMS

Operation

Operation Check

5.2 Operation Check

Write the programs and parameters by following the procedure described in Section 3.4 (Page 23) and check that the programmable controller and inverters communicate data without an error.

Change the programmable controller state from STOP to RUN and check the following.

▶ Turning ON the forward rotation command input

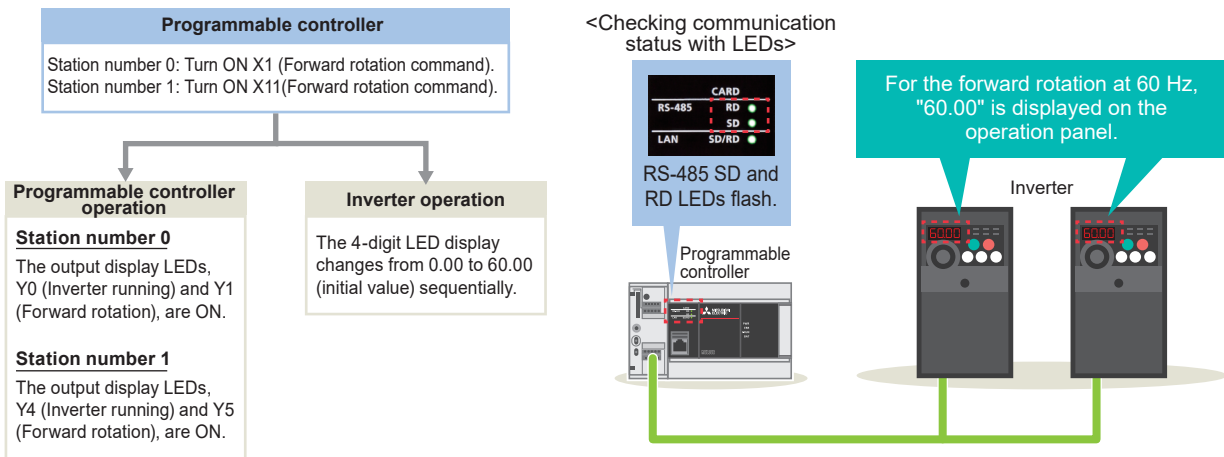

▶ Changing the frequency to 40 Hz (when the forward rotation command remains ON)

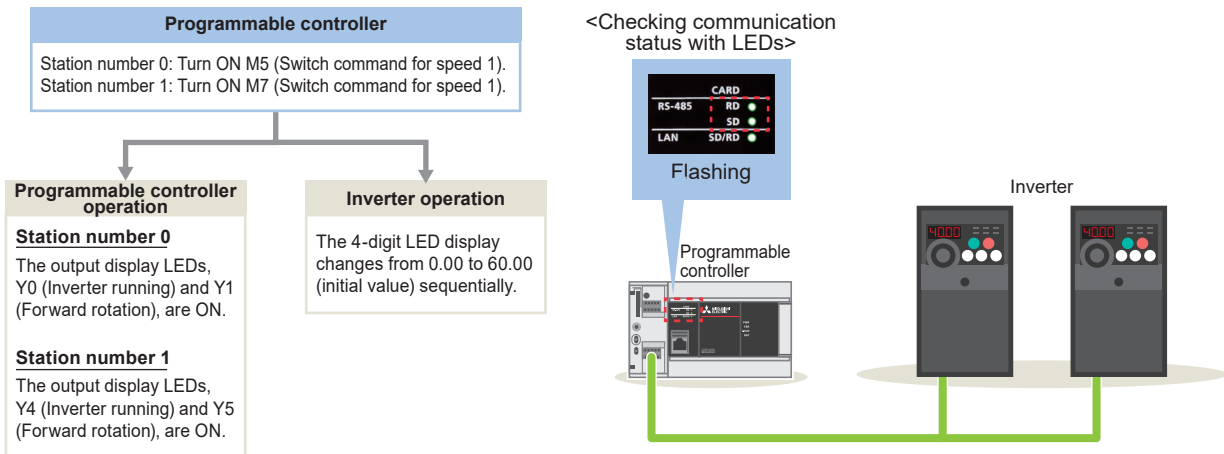

LED status of the programmable controller (RS-485)		Operating status
RD	SD	
Flashing	Flashing	Data is being sent and received from/to the inverters.

When the above operation cannot be observed, refer to → P.30.

Point

When changing a frequency, a switch command, such as M5 and M7, can be turned ON forcibly by following the procedure below.

- 1) Make sure that the ladder diagram is displayed on GX Works3, and press the **F3** key. (The status changes to monitoring.)
- 2) Place a cursor on the device, such as M5 and M7, to be turned ON.
- 3) Hold down the **Shift** key and press the **Enter** key to turn ON. (Hold down the **Shift** key and press the **Enter** key again to turn OFF.) Press the **F2** key to clear the monitor execution status.

6. TROUBLESHOOTING

Checking Procedure

Checking the LED Status

Checking the Error Code

1 PREPARATION

2 INVERTER SETTINGS

3 PROGRAMMABLE CONTROLLER SETTINGS

4 CHECKING COMMUNICATION STATUS

5 EXAMPLE PROGRAMS

6 TROUBLESHOOTING

APPENDIX

6.1 Checking Procedure

1 Checking the LED status → P.31

↓ If data communications between the programmable controller and the inverters are not performed as described on Page 29, check the communication status with the LEDs of the programmable controller.

2 Checking the error code → P.32 to P.34

Check the following depending on the error code stored in the programmable controller.

Wiring → P.8

- Are the cables properly connected?
- Are the LAN connectors fully plugged?

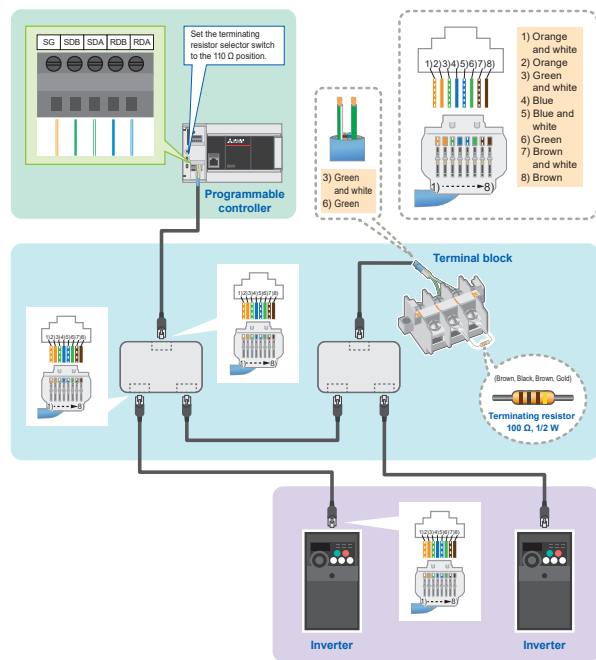

Communication settings → P.14 to P.19

- Do the parameters set using GX Works3 and the parameters written to the inverters match?

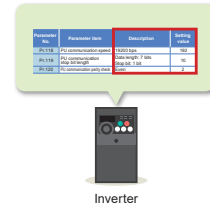

*: If any parameter is set incorrectly, correct the value. Then, power OFF and ON the programmable controller (or reset the CPU module) to reflect the corrected value.

*: If any parameter is set incorrectly, correct the value. Then, power OFF and ON the inverter to reflect the corrected value.

Programs → P.27 to P.29

- Are the programs created as shown in the example programs?

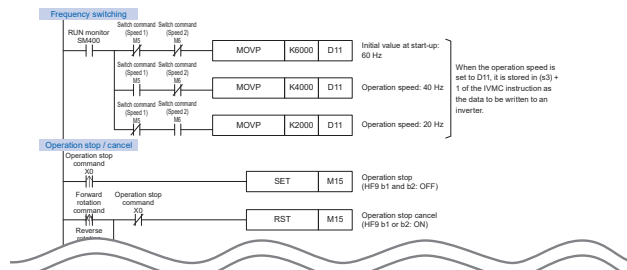

6. TROUBLESHOOTING

Checking Procedure

Checking the LED Status

Checking the Error Code

6.2 Checking the LED Status

If data communications between the programmable controller and the inverter are not performed when the example program is executed, an error occurs.

▶ Turning ON the forward rotation command input

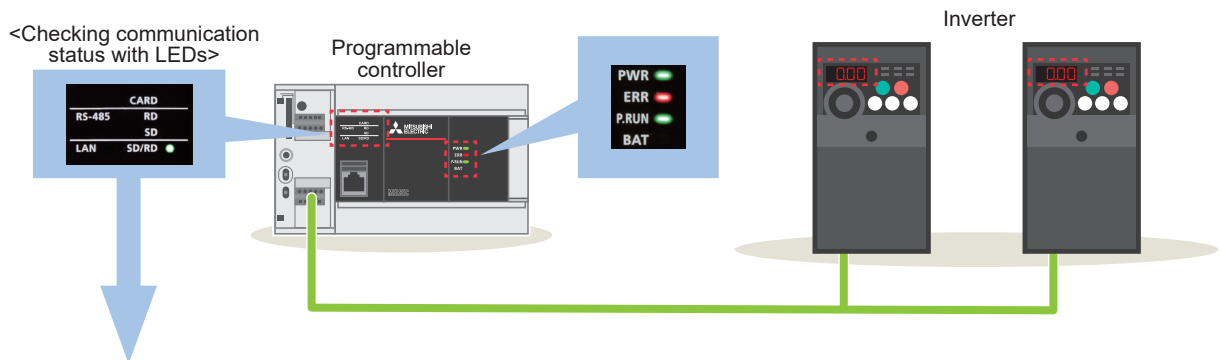
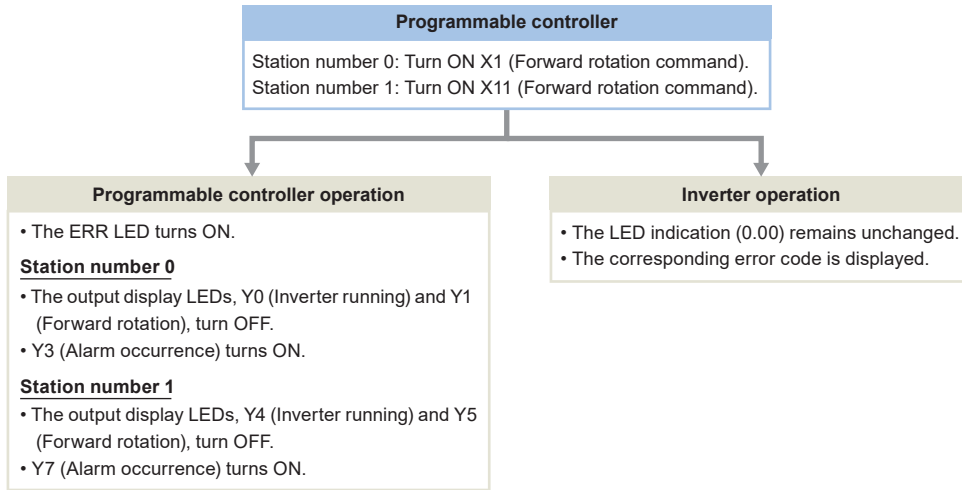

LED status of the programmable controller (RS-485)		Operating status
RD	SD	
ON	OFF	The programmable controller receives data but does not send data.
OFF	ON	The programmable controller sends data but does not receive data.
OFF	OFF	The programmable controller does not send and receive data.

When the programmable controller has one of the above errors, check the error code.

➔ To the next page

For details on the error codes displayed on the FR-D700, refer to

➔ [Section 5.2 List of fault or alarm indications in the FR-D700 INSTRUCTION MANUAL \(Applied\) \(IB\(NA\)-0600366ENG\).](#)

6. TROUBLESHOOTING

Checking Procedure

Checking the LED Status

Checking the Error Code

1 PREPARATION

6.3 Checking the Error Code

When an error occurs in serial communications, the corresponding error code is stored in the special register (SD8500). The error code can be checked with the following devices.

Device (CH1)	Name	Description
SM8500	Serial communication error (CH1)	Turns ON when an error occurs in serial communications.
SD8500	Serial communication error code (CH1)	When an error occurs in serial communications, stores the corresponding error code.

2 INVERTER SETTINGS

3

▶ Monitoring SD8500

1 Select [Online] ⇒ [Watch] ⇒ [Register to Watch Window] ⇒ [Watch Window 1].

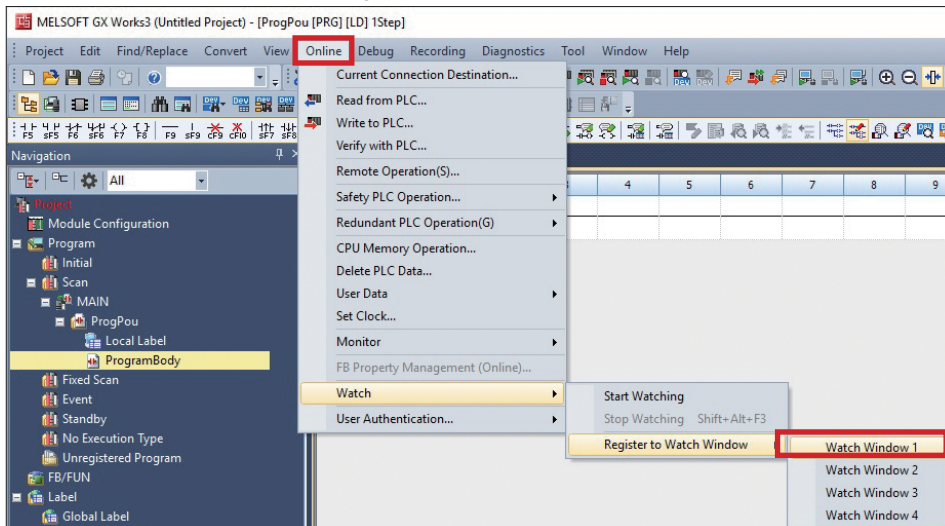

2 Enter "SD8500" in "Name", and select "Hexadecimal" in "Display Format". Right-click on "SD8500", and select [Start Watching].

The screenshot shows the 'Watch 1[Watching]' window. The 'Name' column contains 'SD8500', the 'Current Value' column contains 'H7601', the 'Display Format' column contains 'Hexadecimal', and the 'Data Type' column contains 'Word [Signed]'. A red box highlights the 'Current Value' column, and a red arrow points to it from the text below.

Name	Current Value	Display Format	Data Type
SD8500	H7601	Hexadecimal	Word [Signed]

An error code is displayed.

4 CHECKING COMMUNICATION STATUS

5 EXAMPLE PROGRAMS

6 TROUBLESHOOTING

APPENDIX

6. TROUBLESHOOTING

Checking Procedure

Checking the LED Status

Checking the Error Code

1 PREPARATION

2 INVERTER SETTINGS

3 PROGRAMMABLE CONTROLLER SETTINGS

4 CHECKING COMMUNICATION STATUS

5 EXAMPLE PROGRAMS

6 TROUBLESHOOTING

APPENDIX

Error code (Hexadecimal)	Description		Cause and action	
			Programmable controller	Inverter
0000H	Normal end	(No Errors)	-	
7601H	-	No response from the inverter.	Check the wiring and parameter settings.	
7602H	Timeout error	Sending from inverter was aborted midway.	Check the wiring and parameter settings.	Check the wiring and existence of noise.
7603H	Station number error	An unspecified station gave response.	Check the parameter settings.	Check Pr.117 (PU communication station number) setting.
7604H	Sum check error	The sum of data sent back by the inverter did not match.	Check the parameter settings and operating environment (including existence of noise).	Check the parameter settings, wiring, and existence of noise.
7608H	Sending timeout error	Sending to the inverter was not completed within the specified time.		
7609H	Receive data error	Wrong data was received from the inverter.		
7620H	Computer NAK error	Inverter sent the error code H0. The number of retries exceeded the allowable number because of an error in the transfer request data.		
7621H	Parity error	Inverter sent the error code H1. The contents are different from the specified parity.	Check the parameter settings.	Check Pr.120 (PU communication parity check) setting.
7622H	Sum check error	Inverter sent the error code H2. The sum check code in the computer is different from the sum value calculated from the data received by the inverter.		Check the wiring and existence of noise.
7623H	Protocol error	Inverter sent the error code H3. There is a syntax error in data received by the inverter. Or, data reception is not completed within a certain amount of time. CR/LF does not match parameter setting.		
7624H	Framing error	Inverter sent the error code H4. The stop bit length is different from the initial set value.		
7625H	Overrun error	Inverter sent the error code H5. Before receiving the completed data in the inverter, the computer sent the next set of data.	Check the program.	-
7627H	Character error	Inverter sent the error code H7. An unused character (other than 0 to 9, A to F and control codes) was received.	Check the wiring, existence of noise, or other factors.	-
762AH	Mode error	Inverter sent the error code HA. A parameter was written in a mode other than computer link operation mode, or while the inverter was operating.	Check the program.	Check the operation mode and operation command source, such as Pr.77, Pr.79, and Pr.340, of the inverter.
762BH	Instruction code error	Inverter sent the error code HB. Non-existing instruction code was specified.		-
762CH	Data range error	Inverter sent the error code HC. In writing a parameter or operation frequency, data outside the allowable range was specified.		

The following table lists the error codes stored in SD8500.

For details on the error codes, refer to

➔ [Section 5.9 Troubleshooting in the MELSEC iQ-F FX5 User's Manual \(Serial Communication\) \(JY997D55901\)](#).

6. TROUBLESHOOTING

Checking Procedure

Checking the LED Status

Checking the Error Code

1 PREPARATION

2 INVERTER SETTINGS

3 PROGRAMMABLE CONTROLLER SETTINGS

4 CHECKING COMMUNICATION STATUS

5 EXAMPLE PROGRAMS

6 TROUBLESHOOTING

APPENDIX

The following table lists the error codes stored in SD8500 when an error occurs in the send data of the IVMC instruction.

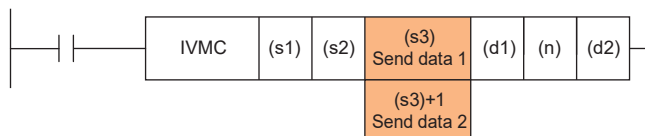

Error code (Hexadecimal)	Description		Cause and action	
	Send data 1 (s3)	Send data 2 (s3) + 1	Programmable controller	Inverter
7640H	<ul style="list-style-type: none"> Mode error A parameter was written in a mode other than computer link operation mode or while inverter was operating. 	Normal value	Check the program.	Check the parameter settings.
7641H	<ul style="list-style-type: none"> Instruction code error Non-existing instruction code was specified. 			-
7642H	<ul style="list-style-type: none"> Data range error Data outside the allowable range was specified. 			-
7643H	Normal value	<ul style="list-style-type: none"> Mode error A parameter was written in a mode other than computer link operation mode or while inverter was operating. 		Check the parameter settings.
7644H		<ul style="list-style-type: none"> Instruction code error Non-existing instruction code was specified. 		-
7645H		<ul style="list-style-type: none"> Data range error Data outside the allowable range was specified. 		-
7646H	Mode error	Mode error		Check the operation mode and operation command source, such as Pr.77, Pr.79, and Pr.340, of the inverter.
7647H	Mode error	Instruction code error		
7648H	Mode error	Data range error		
7649H	Instruction code error	Mode error		
764AH	Instruction code error	Instruction code error		
764BH	Instruction code error	Data range error		
764CH	Data range error	Mode error		
764DH	Data range error	Instruction code error		
764EH	Data range error	Data range error		

APPENDIX

Inverter Communication Instructions

Inverter Communication Instructions

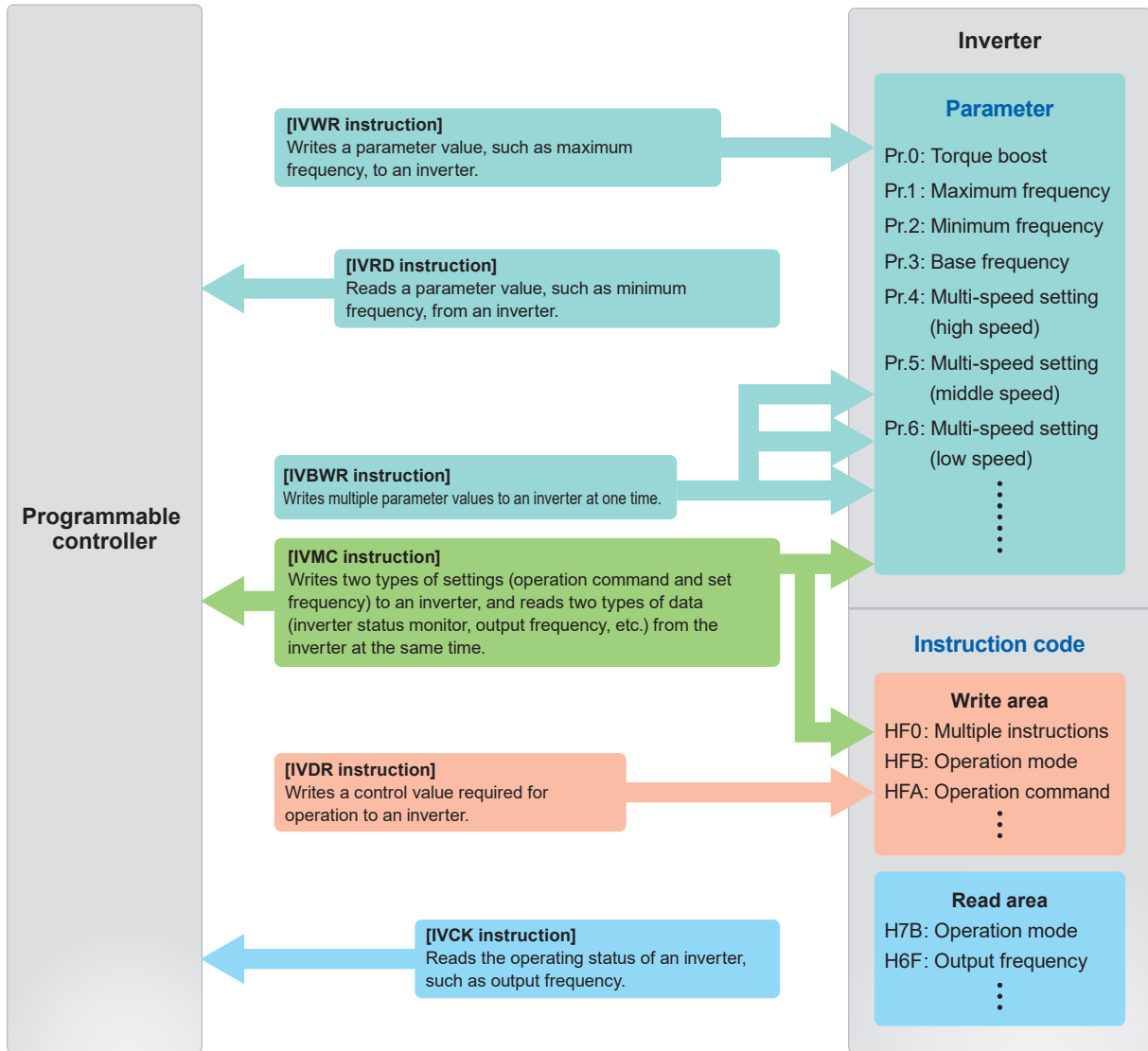

1

PREPARATION

2

INVERTER SETTINGS

3

PROGRAMMABLE CONTROLLER SETTINGS

4

CHECKING COMMUNICATION STATUS

5

EXAMPLE PROGRAMS

6

TROUBLESHOOTING

APPENDIX

APPENDIX

Inverter Communication Instructions

1 PREPARATION

▶ Inverter operation monitoring instruction [IVCK]

This instruction reads the operating status of an inverter and stores the read value in (d1) when an instruction code set in the computer link operation of the inverter is specified.

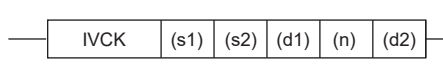

2 INVERTER SETTINGS

Example program

The following program reads the status (H7A) of the inverter (station number 0), stores the read value in M100 to M107 of the programmable controller, and outputs it externally.

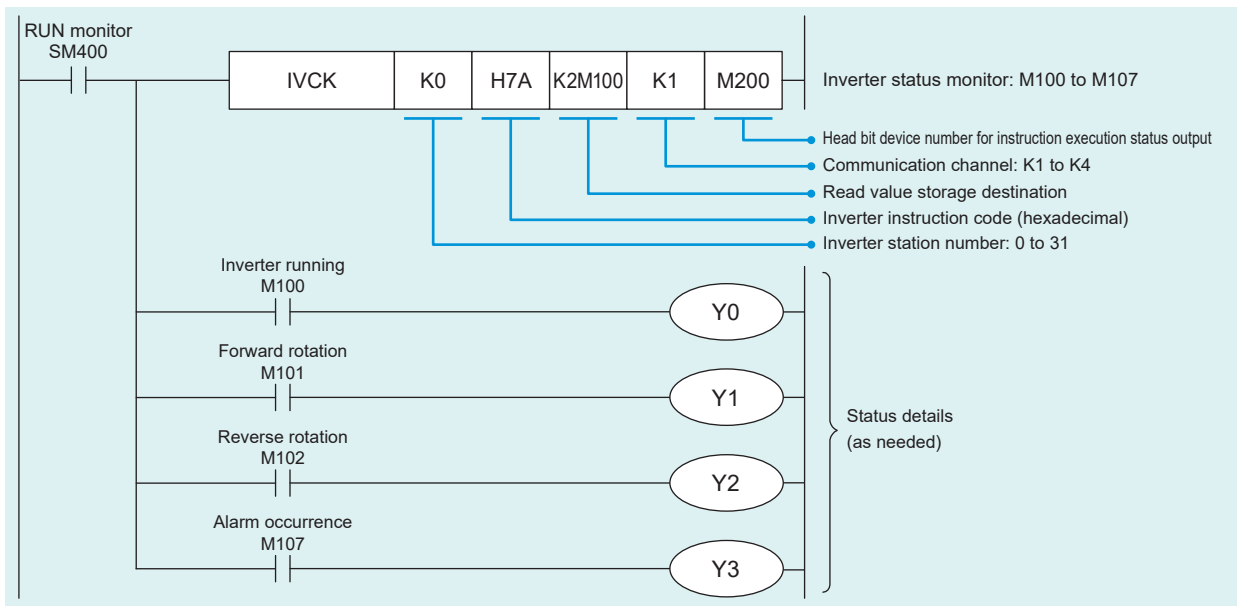

3 PROGRAMMABLE CONTROLLER SETTINGS

4 CHECKING COMMUNICATION STATUS

5 EXAMPLE PROGRAMS

6 TROUBLESHOOTING

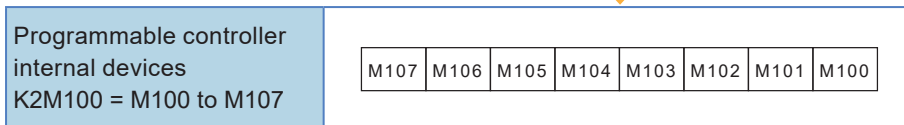
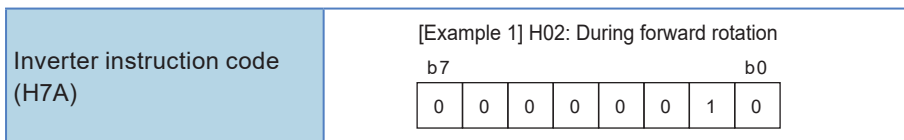

- [Contents]
- b0: RUN
 - b1: During forward rotation (fixed)
 - b2: During reverse rotation (fixed)
 - b3: SU (up-to-frequency) (fixed)
 - b4: OL (overload) (fixed)
 - b5: -
 - b6: FU (frequency detection) (fixed)
 - b7: ABC

*: Make sure not to use devices being used in other control operations.

APPENDIX

APPENDIX

Inverter Communication Instructions

▶ Inverter operation control instruction [IVDR]

This instruction writes the value set in (s3) to a specified inverter parameter when an instruction code set in the computer link operation of the inverter is specified.

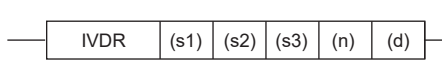

Example program

The following program switches the operation speed (HED) of the inverter (station number 0) using the switch command with 60 Hz as the initial value at start-up.

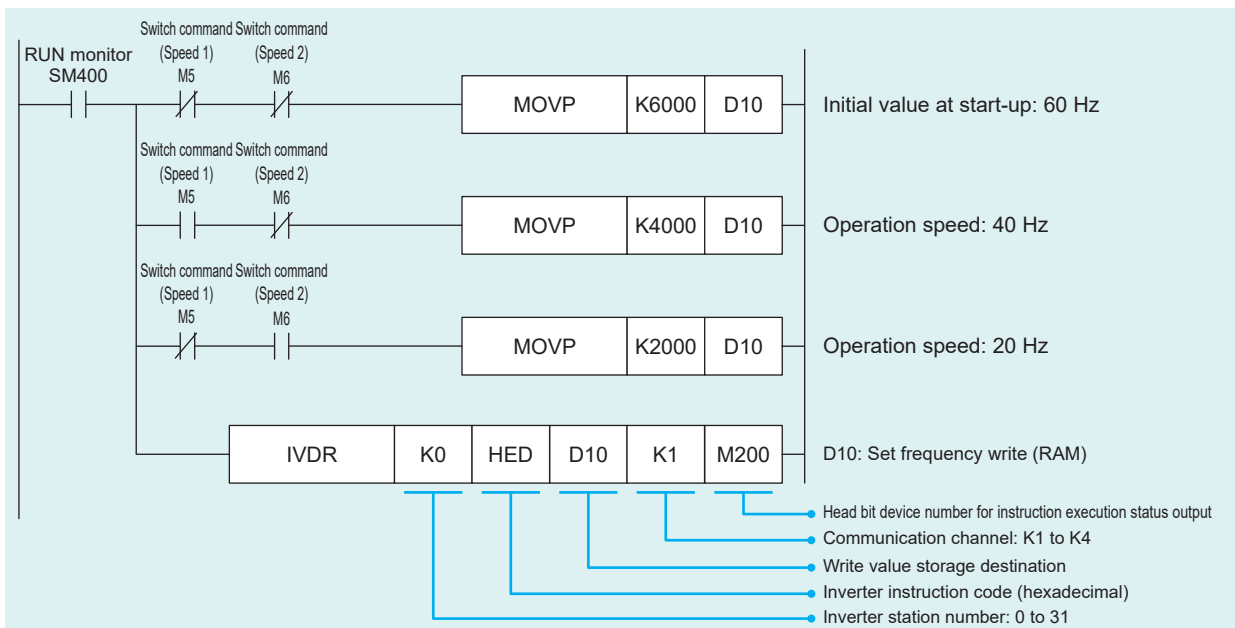

*: Make sure not to use devices being used in other control operations.

APPENDIX

Inverter Communication Instructions

1 PREPARATION

▶ Inverter parameter read [IVRD]

This instruction reads an inverter parameter value and stores the read value in (d1) when a parameter number is specified.

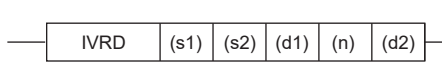

Example program

The following program reads the maximum frequency (Pr.1) of the inverter (station number 0) and stores the read value in D100 of the programmable controller.

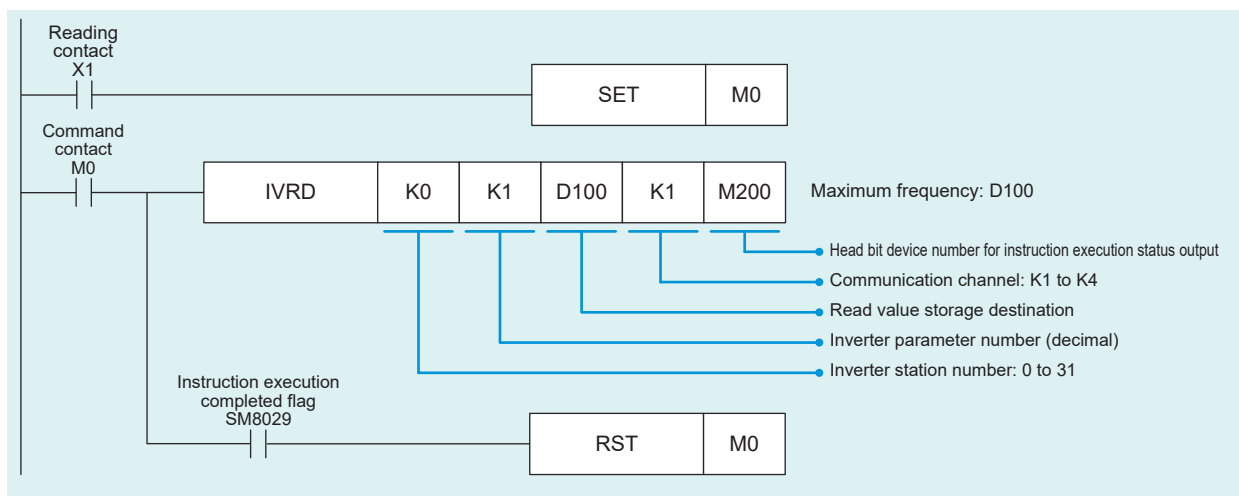

*: Make sure not to use devices being used in other control operations.

2 INVERTER SETTINGS

3 PROGRAMMABLE CONTROLLER SETTINGS

4 CHECKING COMMUNICATION STATUS

5 EXAMPLE PROGRAMS

▶ Inverter parameter write [IVWR]

This instruction writes a value set in (s3) to a specified inverter parameter when a parameter number is specified.

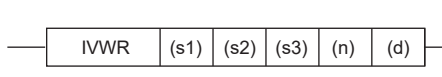

Example program

The following program writes 10 Hz as the setting value to the minimum frequency (Pr.2) of the inverter (station number 0).

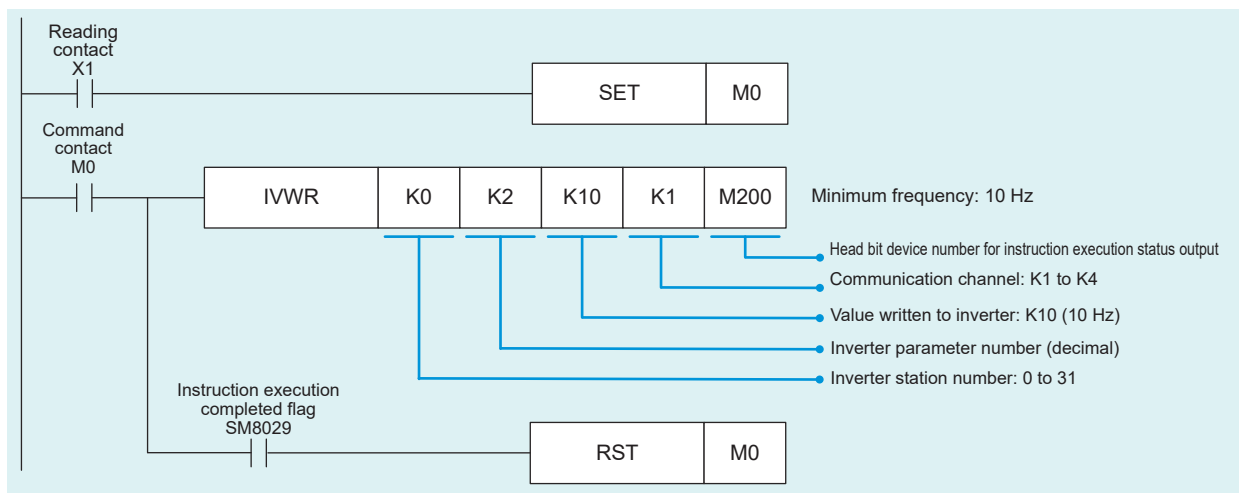

*: Make sure not to use devices being used in other control operations.

6 TROUBLESHOOTING

APPENDIX

APPENDIX

Inverter Communication Instructions

▶ Inverter parameter block write [IVBWR]

This instruction writes the values set in (s3) to specified inverter parameters at one time when parameter numbers are specified.

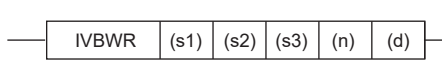

Example program

The following program writes the maximum frequency (Pr.1): 120 Hz, minimum frequency (Pr.2): 5 Hz, acceleration time (Pr.7): 1 s, and deceleration time (Pr.8): 1 s to the inverter (station number 0).

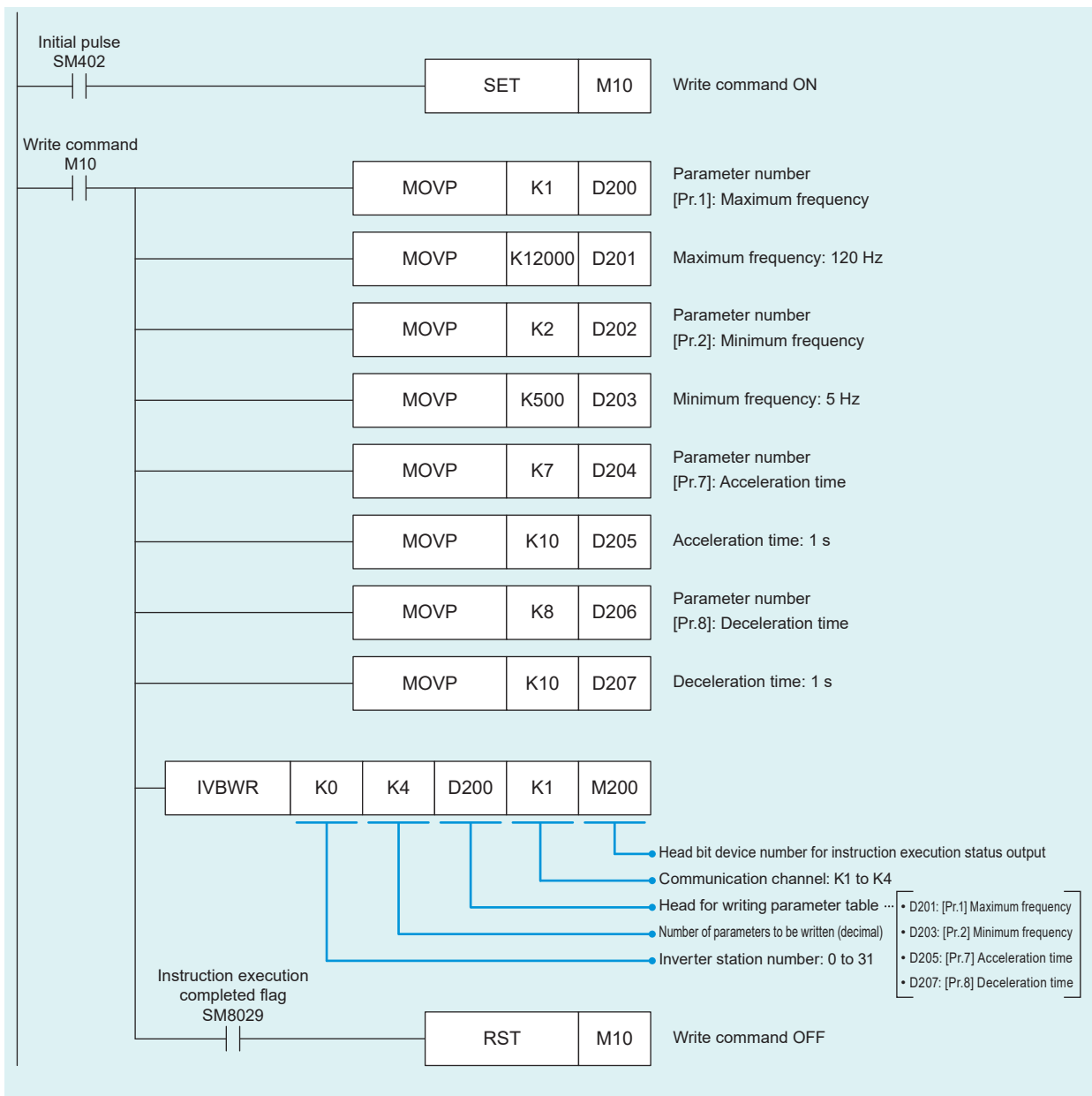

*: Make sure not to use devices being used in other control operations.

APPENDIX

Inverter Communication Instructions

1 PREPARATION

► Multiple inverter commands [IVMC]

This instruction writes two types of settings (operation command and set frequency) to an inverter, and reads two types of data (inverter status monitor, output frequency, etc.) from the inverter at the same time.

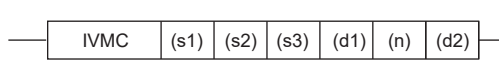

Example program

Refer to ► P.27 (EXAMPLE PROGRAMS).

Point (s3) and (d1) occupy two points each.

*: Make sure not to use devices being used in other control operations.

Others

► Simultaneous driving of instructions and communications

Two or more inverter communication instructions can be programmed, and driven at the same time. When two or more instructions are driven at the same time for the serial port used for communications, the next inverter communication instruction in the program is executed after the current communications with the inverter have finished.

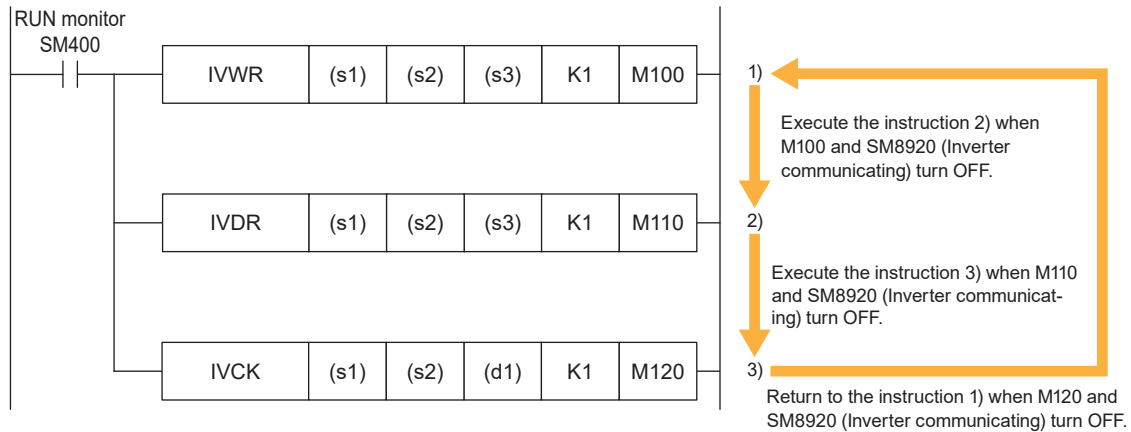

2 INVERTER SETTINGS

3 PROGRAMMABLE CONTROLLER SETTINGS

4 CHECKING COMMUNICATION STATUS

5 EXAMPLE PROGRAMS

6 TROUBLESHOOTING

APPENDIX

APPENDIX

▶ MEMO

1
PREPARATION

2
INVERTER
SETTINGS

3
PROGRAMMABLE
CONTROLLER SETTINGS

4
CHECKING
COMMUNICATION STATUS

5
EXAMPLE
PROGRAMS

6
TROUBLESHOOTING

APPENDIX

APPENDIX

1 PREPARATION

▶ MEMO

2 INVERTER SETTINGS

3 PROGRAMMABLE CONTROLLER SETTINGS

4 CHECKING COMMUNICATION STATUS

5 EXAMPLE PROGRAMS

6 TROUBLESHOOTING

APPENDIX

REVISIONS

*: The manual number is given on the bottom left of the back cover.

Revision date	Manual number	Description
March 2020	L(NA)08706ENG-A	First edition
December 2022	L(NA)08706ENG-B	■ Modified part Front cover, Section 1.3, WARRANTY, TRADEMARKS

This manual confers no industrial property rights or any rights of any other kind, nor does it confer any patent licenses. Mitsubishi Electric Corporation cannot be held responsible for any problems involving industrial property rights which may occur as a result of using the contents noted in this manual.

WARRANTY

Please confirm the following product warranty details before using this product.

- WARRANTY in the FR-D700 INSTRUCTION MANUAL (Basic) (IB-0600438ENG)
- WARRANTY in the MELSEC iQ-F FX5S/FX5UJ/FX5U/FX5UC User's Manual (Hardware) (SH-082452ENG).

SAFETY PRECAUTIONS

- Before using the product introduced in this manual, please read the manuals for the product carefully to handle the product correctly.
- This product has been manufactured as a general-purpose part for general industries, and has not been designed or manufactured to be incorporated in a device or system used in purposes related to human life.
- Before using the product for special purposes such as nuclear power, electric power, aerospace, medicine or passenger movement vehicles, please contact Mitsubishi Electric sales office.
- The product has been manufactured under strict quality control. However when installing the product where major accidents or losses could occur if the product fails, install appropriate backup or failsafe functions into the system.
- For the design and wiring precautions, and other precautions, read "SAFETY PRECAUTIONS" in the relevant manuals.

TRADEMARKS

Microsoft and Windows are trademarks of the Microsoft group of companies.

The company names, system names and product names mentioned in this manual are either registered trademarks or trademarks of their respective companies.

In some cases, trademark symbols such as [™] or [®] are not specified in this manual.

Country/Region	Sales office	Tel/Fax
USA	<p> MITSUBISHI ELECTRIC AUTOMATION, INC. 500 Corporate Woods Parkway, Vernon Hills, IL 60061, U.S.A. </p>	<p> Tel : +1-847-478-2100 Fax : +1-847-478-2253 </p>
Mexico	<p> MITSUBISHI ELECTRIC AUTOMATION, INC. Mexico Branch Boulevard Miguel de Cervantes Saavedra 301, Torre Norte Piso 5, Ampliacion Granada, Miguel Hidalgo, Ciudad de Mexico, Mexico, C.P.115200 </p>	<p> Tel : +52-55-3067-7512 </p>
Brazil	<p> MITSUBISHI ELECTRIC DO BRASIL COMERCIO E SERVICOS LTDA. Avenida Adelino Cardana, 293, 21 andar, Bethaville, Barueri SP, Brasil </p>	<p> Tel : +55-11-4689-3000 Fax : +55-11-4689-3016 </p>
Germany	<p> MITSUBISHI ELECTRIC EUROPE B.V. German Branch Mitsubishi-Electric-Platz 1, 40882 Ratingen, Germany </p>	<p> Tel : +49-2102-486-0 Fax : +49-2102-486-7780 </p>
UK	<p> MITSUBISHI ELECTRIC EUROPE B.V. UK Branch Travellers Lane, UK-Hatfield, Hertfordshire, AL10 8XB, U.K. </p>	<p> Tel : +44-1707-28-8780 Fax : +44-1707-27-8695 </p>
Ireland	<p> MITSUBISHI ELECTRIC EUROPE B.V. Irish Branch Westgate Business Park, Ballymount, Dublin 24, Ireland </p>	<p> Tel : +353-1-4198800 Fax : +353-1-4198890 </p>
Italy	<p> MITSUBISHI ELECTRIC EUROPE B.V. Italian Branch Centro Direzionale Colleoni - Palazzo Sirio, Viale Colleoni 7, 20864 Agrate Brianza (MB), Italy </p>	<p> Tel : +39-039-60531 Fax : +39-039-6053-312 </p>
Spain	<p> MITSUBISHI ELECTRIC EUROPE, B.V. Spanish Branch Carretera de Rubi, 76-80-Apdo. 420, E-08190 Sant Cugat del Valles (Barcelona), Spain </p>	<p> Tel : +34-935-65-3131 Fax : +34-935-89-1579 </p>
France	<p> MITSUBISHI ELECTRIC EUROPE B.V. French Branch 25, Boulevard des Bouvets, 92741 Nanterre Cedex, France </p>	<p> Tel : +33-1-55-68-55-68 Fax : +33-1-55-68-57-57 </p>
Czech Republic	<p> MITSUBISHI ELECTRIC EUROPE B.V. Czech Branch, Prague Office Pekarska 621/7, 155 00 Praha 5, Czech Republic </p>	<p> Tel : +420-255-719-200 </p>
Poland	<p> MITSUBISHI ELECTRIC EUROPE B.V. Polish Branch ul. Krakowska 48, 32-083 Balice, Poland </p>	<p> Tel : +48-12-347-65-00 </p>
Sweden	<p> MITSUBISHI ELECTRIC EUROPE B.V. (Scandinavia) Hedvig Mollersgata 6, 223 55 Lund, Sweden </p>	<p> Tel : +46-8-625-10-00 Fax : +46-46-39-70-18 </p>
Russia	<p> MITSUBISHI ELECTRIC (RUSSIA) LLC St. Petersburg Branch Piskarevsky pr. 2, bld 2, lit "Sch", BC "Benua", office 720; 195027 St. Petersburg, Russia </p>	<p> Tel : +7-812-633-3497 Fax : +7-812-633-3499 </p>
Turkey	<p> MITSUBISHI ELECTRIC TURKEY A.S. Umraniye Branch Serifali Mah. Kale Sok. No:41 34775 Umraniye - Istanbul, Turkey </p>	<p> Tel : +90-216-969-2500 Fax : +90-216-661-4447 </p>
UAE	<p> MITSUBISHI ELECTRIC EUROPE B.V. Dubai Branch Dubai Silicon Oasis, P.O.BOX 341241, Dubai, U.A.E. </p>	<p> Tel : +971-4-3724716 Fax : +971-4-3724721 </p>
South Africa	<p> ADROIT TECHNOLOGIES 20 Waterford Office Park, 189 Witkoppen Road, Fourways, South Africa </p>	<p> Tel : +27-11-658-8100 Fax : +27-11-658-8101 </p>
China	<p> MITSUBISHI ELECTRIC AUTOMATION (CHINA) LTD. Mitsubishi Electric Automation Center, No.1386 Hongqiao Road, Shanghai, China </p>	<p> Tel : +86-21-2322-3030 Fax : +86-21-2322-3000 </p>
Taiwan	<p> SETSUYO ENTERPRISE CO., LTD. 6F, No.105, Wugong 3rd Road, Wugu District, New Taipei City 24889, Taiwan </p>	<p> Tel : +886-2-2299-2499 Fax : +886-2-2299-2509 </p>
Korea	<p> MITSUBISHI ELECTRIC AUTOMATION KOREA CO., LTD. 7F to 9F, Gangseo Hangang Xi-tower A, 401, Yangcheon-ro, Gangseo-Gu, Seoul 07528, Korea </p>	<p> Tel : +82-2-3660-9569 Fax : +82-2-3664-8372 </p>
Singapore	<p> MITSUBISHI ELECTRIC ASIA PTE. LTD. 307 Alexandra Road, Mitsubishi Electric Building, Singapore 159943 </p>	<p> Tel : +65-6473-2308 Fax : +65-6476-7439 </p>
Thailand	<p> MITSUBISHI ELECTRIC FACTORY AUTOMATION (THAILAND) CO., LTD. 12th Floor, SV.City Building, Office Tower 1, No. 896/19 and 20 Rama 3 Road, Kwaeng Bangpongpan, Khet Yannawa, Bangkok 10120, Thailand </p>	<p> Tel : +66-2682-6522-31 Fax : +66-2682-6020 </p>
Vietnam	<p> MITSUBISHI ELECTRIC VIETNAM COMPANY LIMITED Unit 01-04, 10th Floor, Vincom Center, 72 Le Thanh Ton Street, District 1, Ho Chi Minh City, Vietnam </p>	<p> Tel : +84-28-3910-5945 Fax : +84-28-3910-5947 </p>
Indonesia	<p> PT. MITSUBISHI ELECTRIC INDONESIA Gedung Jaya 8th Floor, JL. MH. Thamrin No.12, Jakarta Pusat 10340, Indonesia </p>	<p> Tel : +62-21-31926461 Fax : +62-21-31923942 </p>
India	<p> MITSUBISHI ELECTRIC INDIA PVT. LTD. Pune Branch Emerald House, EL-3, J Block, M.I.D.C., Bhosari, Pune-411026, Maharashtra, India </p>	<p> Tel : +91-20-2710-2000 Fax : +91-20-2710-2100 </p>
Australia	<p> MITSUBISHI ELECTRIC AUSTRALIA PTY. LTD. 348 Victoria Road, P.O. Box 11, Rydalmere, N.S.W 2116, Australia </p>	<p> Tel : +61-2-9684-7777 Fax : +61-2-9684-7245 </p>

MITSUBISHI ELECTRIC CORPORATION
HEAD OFFICE: TOKYO BLDG., 2-7-3, MARUNOUCHI, CHIYODA-KU, TOKYO 100-8310, JAPAN
www.MitsubishiElectric.com