

FACTORY AUTOMATION

Mitsubishi Electric Programmable Controller MELSEC iQ-F Series

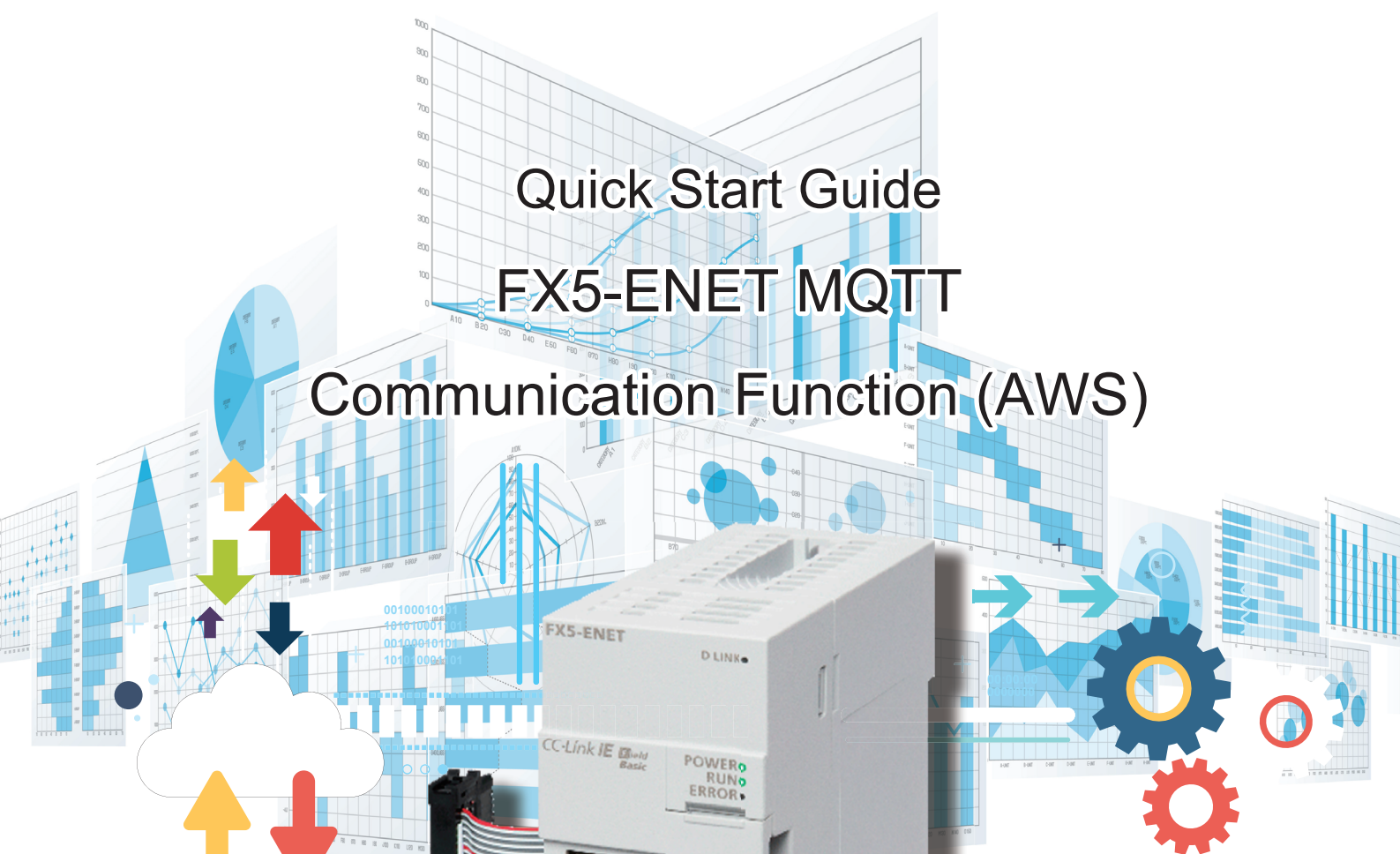

Quick Start Guide
FX5-ENET MQTT
Communication Function (AWS)

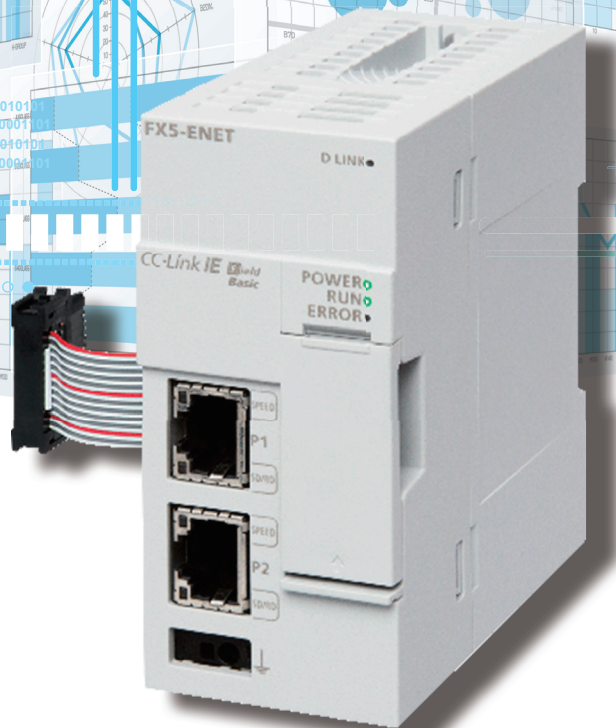

MELSEC iQ-F
series

INTRODUCTION

Thank you for purchasing the MELSEC iQ-F series.

This manual describes the setting method for connecting to Amazon Web Services (hereinafter referred to as AWS) to send/receive JSON strings using the FX5-ENET Ethernet module (hereinafter referred to as FX5-ENET).

Before using this product, please read this manual and the relevant manuals carefully and develop familiarity with the specifications to handle the product correctly.

When applying the program examples provided in this manual to an actual system, ensure the applicability and confirm that it will not cause system control problems.

The screen images in this manual were captured when the manual was created. For the latest information, check the website of AWS.

Regarding use of this product

- This product has been manufactured as a general-purpose part for general industries, and has not been designed or manufactured to be incorporated in a device or system used in purposes related to human life.
- Before using the product for special purposes such as nuclear power, electric power, aerospace, medicine or passenger movement vehicles, please contact Mitsubishi Electric sales office.
- This product has been manufactured under strict quality control. However when installing the product where major accidents or losses could occur if the product fails, install appropriate backup or failsafe functions into the system.

Note

- If in doubt at any stage during the installation of the product, always consult a professional electrical engineer who is qualified and trained to the local and national standards. If in doubt about the operation or use, please contact your local Mitsubishi Electric representative.
- Mitsubishi Electric will not accept responsibility for actual use of the product based on these illustrative examples. Please use it after confirming the function and safety of the equipment and system.
- The content, specifications etc. of this manual may be changed, for improvement, without notice.
- The information in this manual has been carefully checked and is believed to be accurate; however, if you notice a doubtful point, an error, etc., please contact your local Mitsubishi Electric representative. When doing so, please provide the manual number given at the end of this manual.

CONTENTS

INTRODUCTION	1
RELEVANT MANUALS	4
TERMS	5
GENERIC TERMS AND ABBREVIATIONS	5
KEY FEATURES	6
CHAPTER 1 APPLICABLE MODELS	7
CHAPTER 2 PREPARATION	9
2.1 System Configuration	9
2.2 Required Products and Software	10
2.3 Wiring	10
2.4 Operation Flow Diagram	11
CHAPTER 3 CONFIGURING CLIENTS (MQTT PUBLISHER, MQTT SUBSCRIBER)	12
3.1 Configuring Settings with GX Works3	12
Procedure for setting parameters	12
Configuring communication settings with GX Works3	17
Writing data to the programmable controller	19
3.2 Configuring Settings with Certificate Configuration Tool for FX5-ENET	22
CHAPTER 4 CONFIGURING SERVER (MQTT BROKER) CONNECTION	25
4.1 Configuring Settings with AWS	25
Sign-in	25
Configuring settings with AWS IoT services	26
Checking an endpoint	36
4.2 Configuring Settings with Certificate Configuration Tool for FX5-ENET	37
Writing a certificate	37
4.3 Configuring Settings with GX Works3	40
CHAPTER 5 CHECKING OPERATIONS	41
5.1 Checking the Operation of Connect (MQTT Connection Establishment)	41
5.2 Checking the Operation of Subscribe (Sending of Subscribe Command)	44
5.3 Checking the Operation of Publish (Sending of MQTT Data)	45
5.4 Checking the Operation of Subscribe (Receiving of MQTT Data)	47
CHAPTER 6 TROUBLESHOOTING	50
6.1 Checking Procedure	50
APPENDICES	52
Appendix 1 List of FX5 Ethernet-equipped Module FBs	52
Appendix 2 FB Library	53
Downloading the FB library	53
Importing the FB library	54
How to use the FB library	56
Appendix 3 How to Use the Program Copy Function of e-Manual	58

REVISIONS61
WARRANTY62
TRADEMARKS62

RELEVANT MANUALS

The following relevant manuals can be downloaded from the Mitsubishi Electric FA site.

www.mitsubishielectric.co.jp/fa/ref/ref.html?kisyu=plcf&manual=download_all

[○: Available, —: Not available]

Manual name <manual number>	Available form	
	e-Manual	PDF
MELSEC iQ-F FX5S/FX5UJ/FX5U/FX5UC User's Manual (Hardware) <SH-082452ENG>	○	○
MELSEC iQ-F FX5 User's Manual (Application) <JY997D55401>	○	○
MELSEC iQ-F FX5 Programming Manual (Program Design) <JY997D55701>	○	○
MELSEC iQ-F FX5 Programming Manual (Instructions, Standard Functions/Function Blocks) <JY997D55801>	○	○
MELSEC iQ-F FX5 User's Manual (Communication) <SH-082625ENG>	○	○
MELSEC iQ-F FX5 Ethernet Module User's Manual <SH-082026ENG>	○	○
MELSEC iQ-F FX5 Ethernet, EtherNet/IP, CC-Link IE Function Block Reference <JY997D64901>	○	○
MELSEC iQ-F Character String Operation Function Block Library Reference <SH-082619ENG>	○	○
GX Works3 Operating Manual <SH-081215ENG>	○	○



Quick and satisfying browsing

e-Manual Viewer

e-Manual Viewer allows users to browse optimized FA-related documents such as Mitsubishi Electric FA product manuals. e-Manual Viewer can be downloaded for free from the Mitsubishi Electric FA website.

Easy on-demand download of latest documents

All necessary documents can be easily downloaded with one click. The latest documents are available at any time.

Quick cross document search for necessary information

Refine search and fuzzy search are available for all downloaded documents. Intuitive search using illustrations is available for hardware specifications of the product.

Copying program examples to an engineering tool

Program examples contained in a document can be directly copied to an engineering tool, eliminating the need of inputting the programs.

Sharing information among multiple users

The documents can be customized by adding useful information as a note freely. Latest documents and notes can be shared with multiple users using the document sharing function.



■ Introduction for the concept and features of e-Manual Viewer is available on the following website.

www.mitsubishielectric.com/fa/ref/ref.html?k=plceng&smerit=emaviewer_win

■ The installation file for Windows® can be downloaded from the following website.

www.mitsubishielectric.com/fa/ref/ref.html?k=plceng&software=emaviewer_en

TERMS

Unless otherwise specified, this manual uses the following terms.

Term	Description
Broker	An MQTT server that mediates messages (MQTT broker)
Engineering tool	The product name of the software package for the MELSEC programmable controllers
Message	Data to be exchanged between the sender (publisher) and receiver (subscriber)
Publish/Subscribe message exchange model	A protocol capable of one-to-many asynchronous communications. The sender of a message is called a publisher, the receiver is called a subscriber, and an entity playing an intermediate role is called a broker. The term "publish" means "send", and "subscribe" means "receive".
Topic	A key to be used for messaging. In the topic hierarchy, a slash (/) is regarded as a delimiter. For example, when multiple sensors send their individual information to the topic, the messages can be appropriately organized according to their installation location and device name.
Will	This function sends a Will message with a specified Will topic name to subscribers when the publisher is disconnected and the server communications are disabled. If any unexpected disconnection or such an event occurs, subscribers can judge that the publisher is disconnected.

GENERIC TERMS AND ABBREVIATIONS

Unless otherwise specified, this manual uses the following generic terms and abbreviations.

Generic term/abbreviation	Description
FX5U CPU module	A generic term for the FX5U-32MR/ES, FX5U-32MT/ES, FX5U-32MT/ESS, FX5U-64MR/ES, FX5U-64MT/ES, FX5U-64MT/ESS, FX5U-80MR/ES, FX5U-80MT/ES, FX5U-80MT/ESS, FX5U-32MR/DS, FX5U-32MT/DS, FX5U-32MT/DSS, FX5U-64MR/DS, FX5U-64MT/DS, FX5U-64MT/DSS, FX5U-80MR/DS, FX5U-80MT/DS, and FX5U-80MT/DSS
FX5UC CPU module	A generic term for the FX5UC-32MT/D, FX5UC-32MT/DSS, FX5UC-64MT/D, FX5UC-64MT/DSS, FX5UC-96MT/D, FX5UC-96MT/DSS, FX5UC-32MT/DS-TS, FX5UC-32MT/DSS-TS, and FX5UC-32MR/DS-TS
FX5UJ CPU module	A generic term for the FX5UJ-24MR/ES, FX5UJ-24MT/ES, FX5UJ-24MT/ESS, FX5UJ-40MR/ES, FX5UJ-40MT/ES, FX5UJ-40MT/ESS, FX5UJ-60MR/ES, FX5UJ-60MT/ES, FX5UJ-60MT/ESS, FX5UJ-24MR/DS, FX5UJ-24MT/DS, FX5UJ-24MT/DSS, FX5UJ-40MR/DS, FX5UJ-40MT/DS, FX5UJ-40MT/DSS, FX5UJ-60MR/DS, FX5UJ-60MT/DS, and FX5UJ-60MT/DSS
GX Works3	A generic product name for the product model SWnDND-GXW3 (where n represents the version)

KEY FEATURES

Point1

Publish: Sending information collected in the FX5 CPU module to the MQTT broker with the MQTT communication function, **Subscribe:** Subscribing the information from the MQTT broker

MQTT is an OASIS-standard communication protocol using a publish/subscribe message exchange model. Once the FX5-ENET executes publishing to the MQTT broker, information is distributed to all the information receive devices that have executed the subscribe request.

In addition, secure communication encrypted with TLS (MQTTS) is also supported.

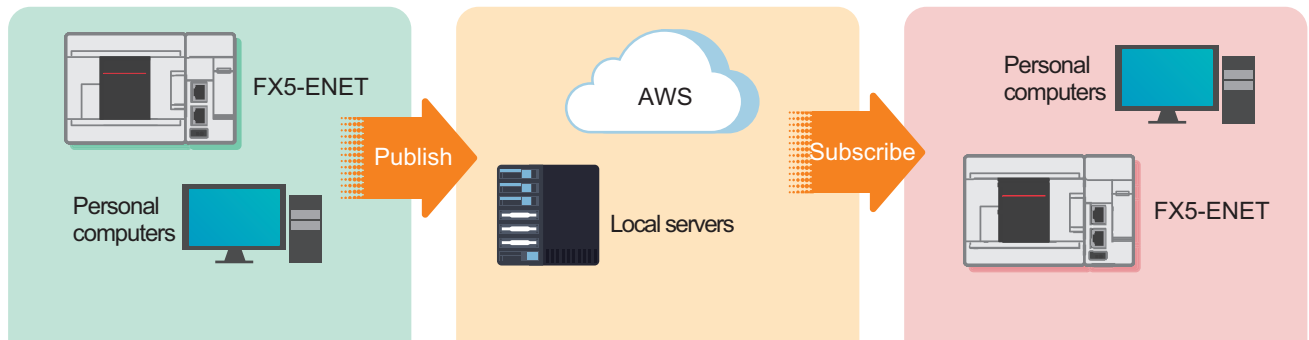

Point2

Cloud connection

Connecting to AWS enables handling of information without preparation of the computing environment.

Various services prepared by AWS (not only data accumulation, but also services such as data visualization and AI predictions) are available.



Point3

Interconnection with programmable controllers in a wide area, and managing them collectively



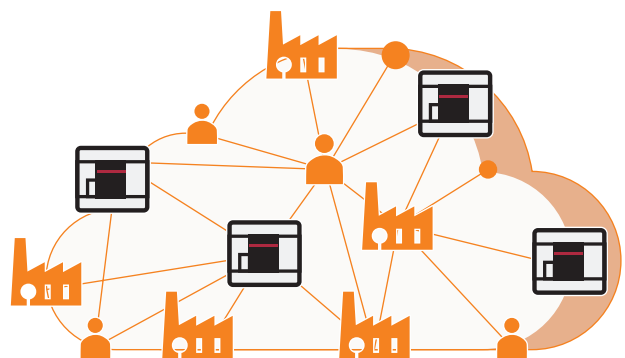

Cloud connection enables a wide-area network connection, which achieves quick resource sharing.

In addition, the programmable controllers can be collectively managed by creating a security group or granting the access right.

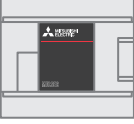

1 APPLICABLE MODELS

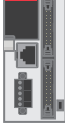
The following models can be used for a series of operations described in this manual.

FX5UJ CPU module	FX5U CPU module	FX5UC CPU module	Ethernet module (FX5-ENET)
			

2 PREPARATION

This manual describes a configuration example in which an FX5-ENET is connected to an FX5U CPU module and is connected to AWS via a router.

To use applicable CPU modules other than the FX5U CPU module, refer to the following manuals.

📖 MELSEC iQ-F FX5S/FX5UJ/FX5U/FX5UC User's Manual (Hardware)

📖 MELSEC iQ-F FX5 Ethernet Module User's Manual, Appendix 7 Added and Changed Functions

2.1 System Configuration

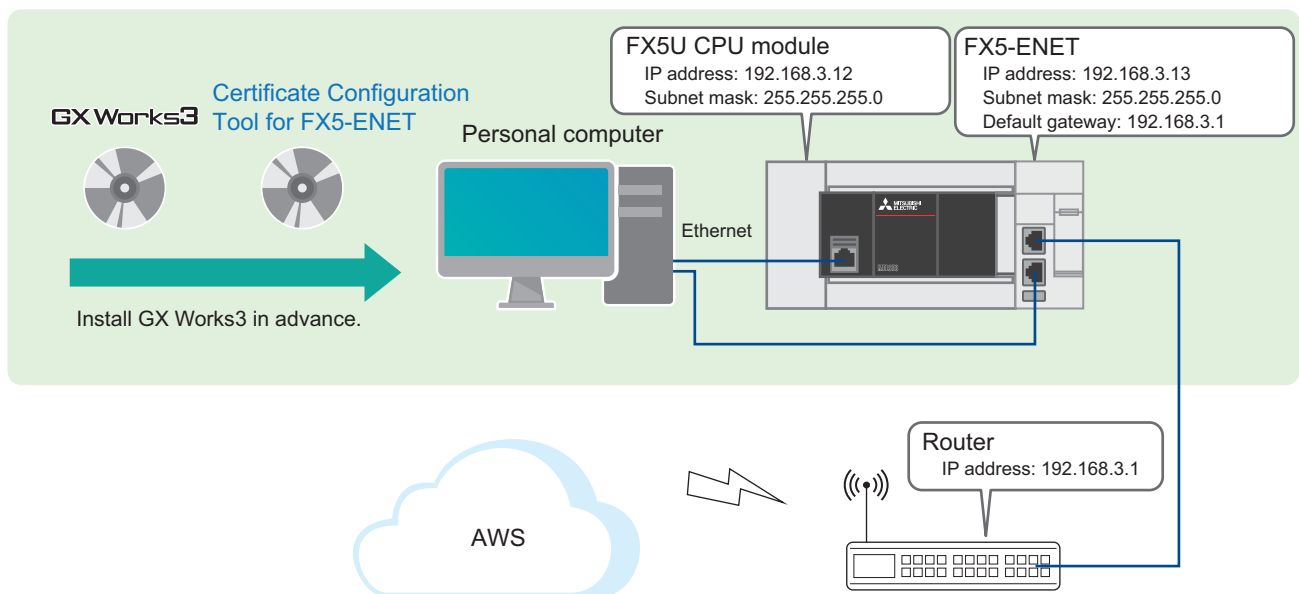

This section describes the system configuration in which one FX5-ENET is connected to one FX5U CPU module and is connected to AWS via a router.





Point

- Register an AWS account and prepare an IAM user in advance.
- Prepare an Internet line on which a port 8883 can be used.

2.2 Required Products and Software

One FX5U CPU module	One FX5-ENET	Personal computer and software
 <p>Use an FX5U CPU module that meets the following conditions.</p> <ul style="list-style-type: none"> • Serial number: 17X**** or later • Firmware version: 1.280 or later 	 <p>Use an FX5-ENET that meets the following conditions.</p> <ul style="list-style-type: none"> • Serial number: 234**** or later • Firmware version: 1.200 or later 	 <p>GX Works3^{*1}</p> <ul style="list-style-type: none"> • Applicable software version: 1.095Z or later Certificate Configuration Tool for FX5-ENET^{*1} • Applicable software version: 1.00A or later

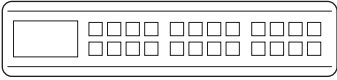
*1 To obtain the latest version, please contact your local Mitsubishi Electric representative.

Router	Three Ethernet cables	AWS account
 <p>Use the router for connecting the programmable controller to AWS.</p>	 <p>Use these cables for connecting the personal computer and the FX5U CPU module, the personal computer and the FX5-ENET, and the FX5-ENET and the router.</p> <p>Use an Ethernet cable compliant with the following standards.</p> <ul style="list-style-type: none"> • Category 5 or higher, straight cable (double shielded/STP) • IEEE 802.3 (100BASE-TX) • ANSI/TIA/EIA-568-B (Category 5) 	 <p>Register an AWS account and prepare an IAM user in advance.</p>

FB library

GX Works3 must import the following.

Name	File name	Reference
Character string operation FB library	StrProcessing_F.mslm	Page 53 FB Library

2.3 Wiring

For the power supply wiring of the FX5U CPU module, refer to the following.

📖 MELSEC iQ-F FX5S/FX5UJ/FX5U/FX5UC User's Manual (Hardware), Section 15.4 Power Supply Wiring

2.4 Operation Flow Diagram

1. Preparing the required products (wiring)

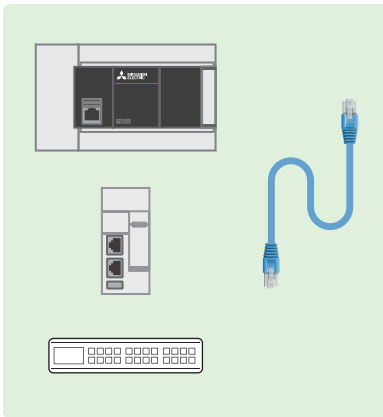

2. Configuring the clients (MQTT Publisher, MQTT Subscriber)

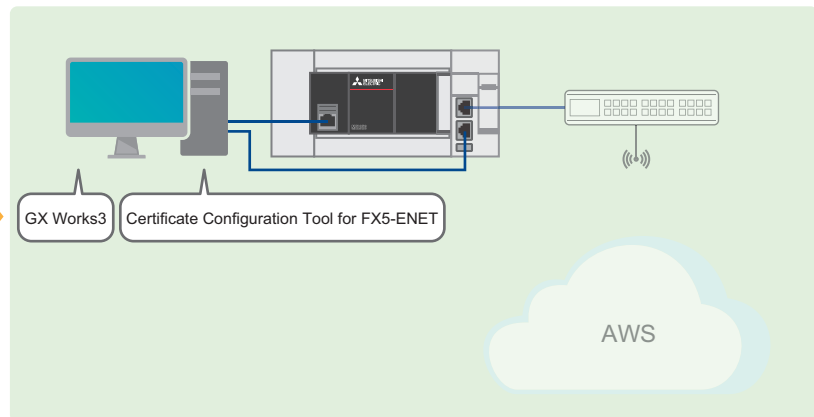

3. Configuring the server (MQTT broker) connection

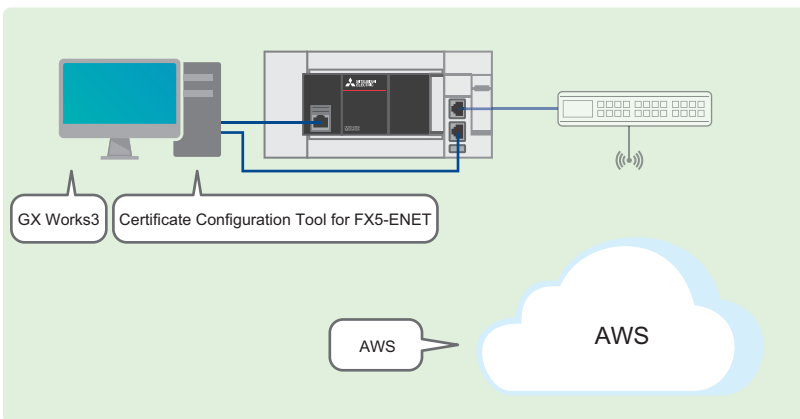

4. Program examples and checking the operation

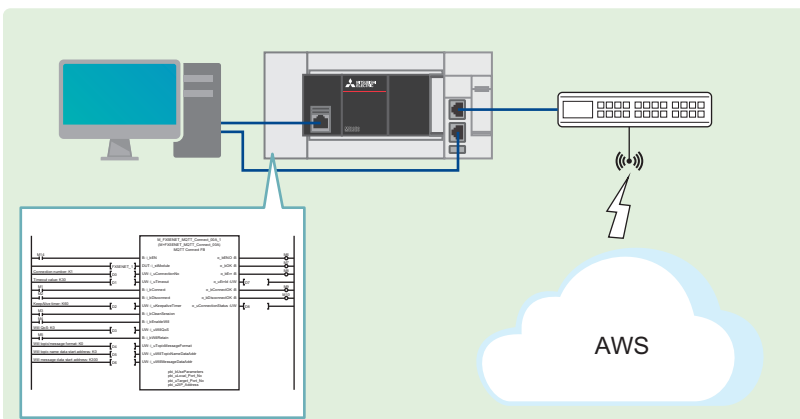

3 CONFIGURING CLIENTS (MQTT PUBLISHER, MQTT SUBSCRIBER)

This chapter describes the setting items for the clients (MQTT Publisher, MQTT Subscriber).

3.1 Configuring Settings with GX Works3

This section describes how to configure the settings with GX Works3.

Procedure for setting parameters

1. Open the "Navigation" window ⇒ [Module Configuration]. Drag and drop [FX5-ENET] to add it.

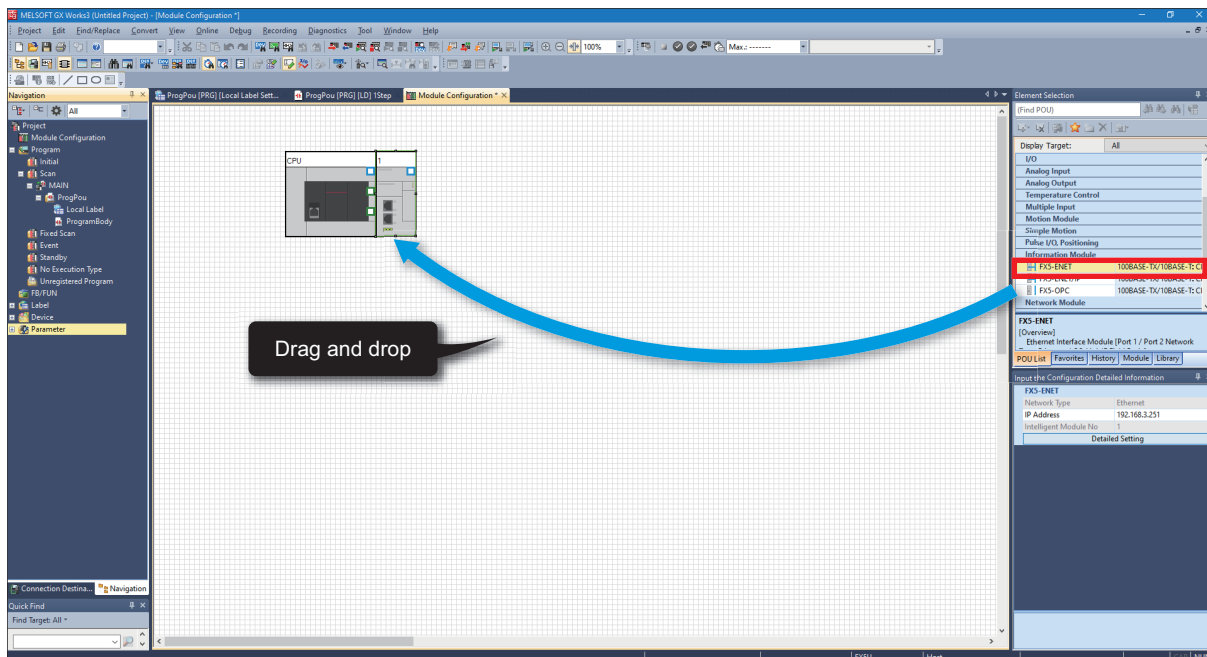

2. Double-click [FX5-ENET] on [Module Configuration]. Click the [Yes] button.

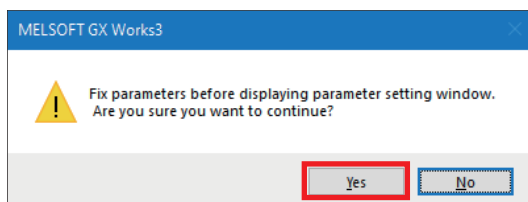

3. Click the [Setting Change] button.

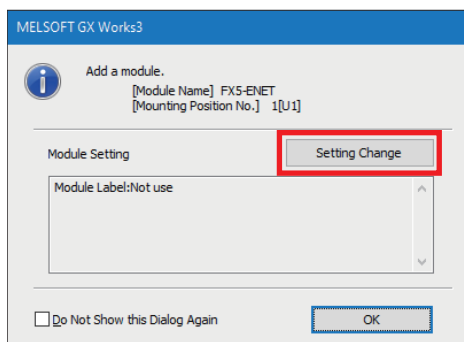

4. Change [Use Module Label] to [Yes] and click the [OK] button.

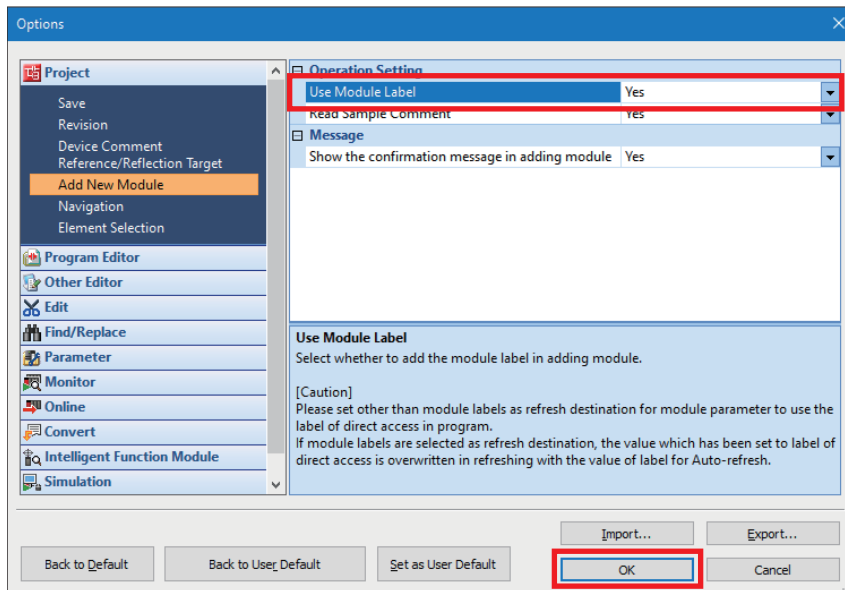

5. Click the [OK] button.

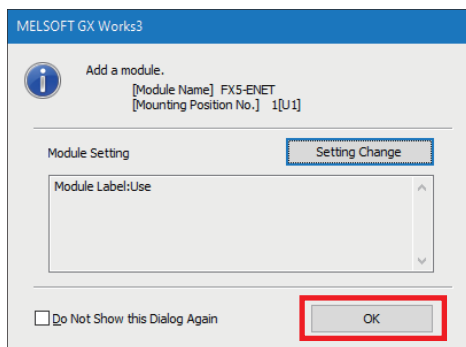

6. Select [Basic Settings] ⇒ [Own Node Settings] and configure [IP Address] as shown below.

Item	Setting
IP Address	192.168.3.13
Subnet Mask	255.255.255.0
Default Gateway	192.168.3.1

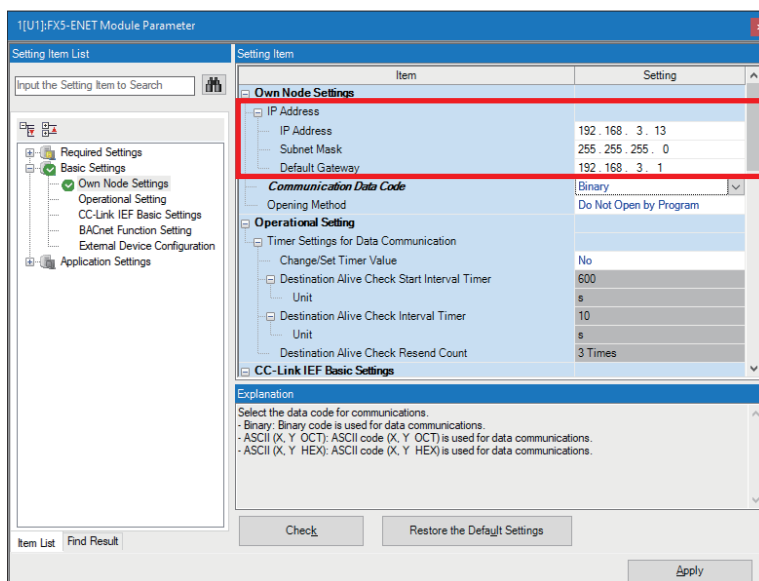

7. Select [Basic Settings] ⇒ [External Device Configuration] and double-click <Detailed Setting>.

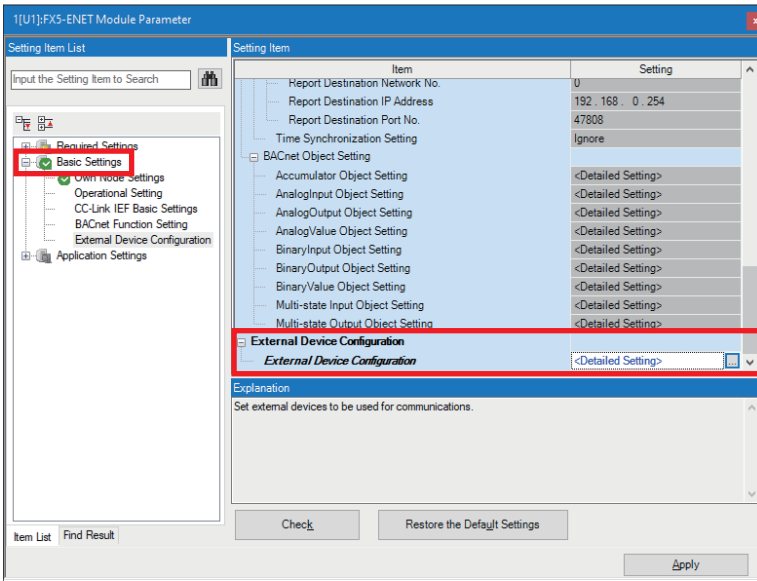

8. Drag and drop [MQTT Connection Module] to add it. Set the protocol and port number as shown below, and click [Close with Reflecting the Setting].

Item	Setting
Protocol	TLS
Port No.	50000

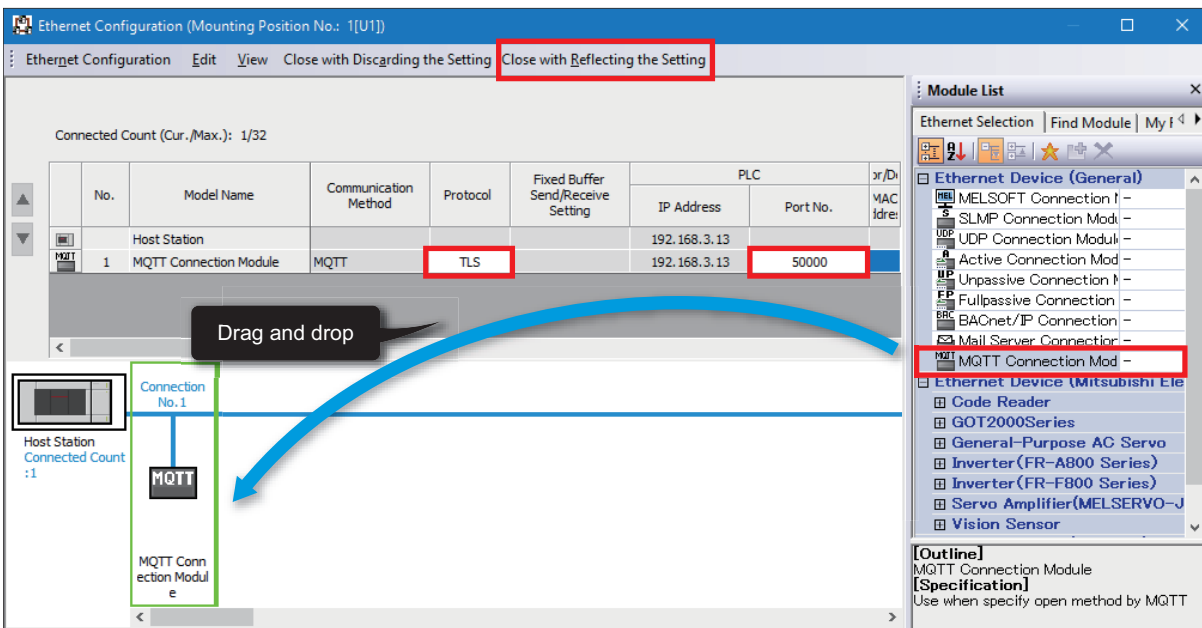

9. Select [Application Settings] and configure [DNS Settings] as shown below.

Item	Setting
To Use or Not to Use DNS Server Settings	Use
DNS Server 1 Address	8.8.8.8
DNS Server 2 Address	8.8.4.4
DNS Server 3 Address	1.1.1.1
DNS Server 4 Address	1.0.0.1

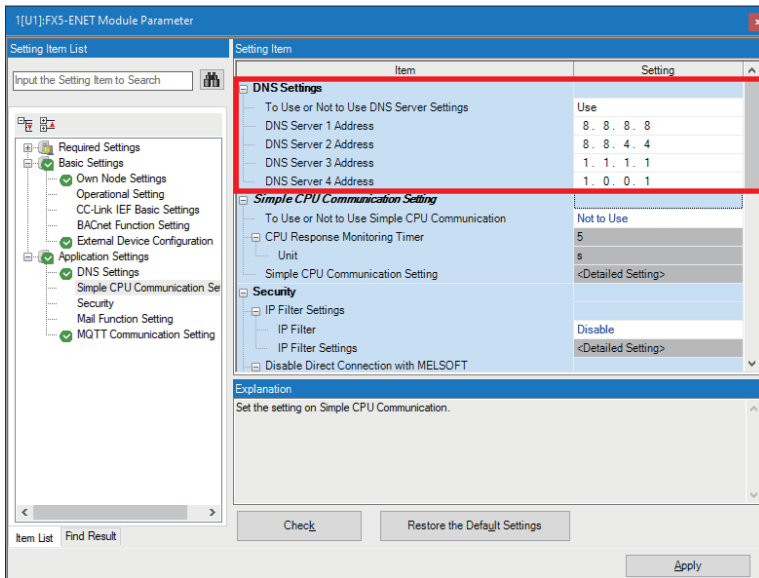

10. Select [Application Settings] ⇒ [MQTT Communication Setting], check that [To Use or Not to Use MQTT Function] is set to "Used", and double-click <Detailed Setting> of [MQTT Connection Setting].

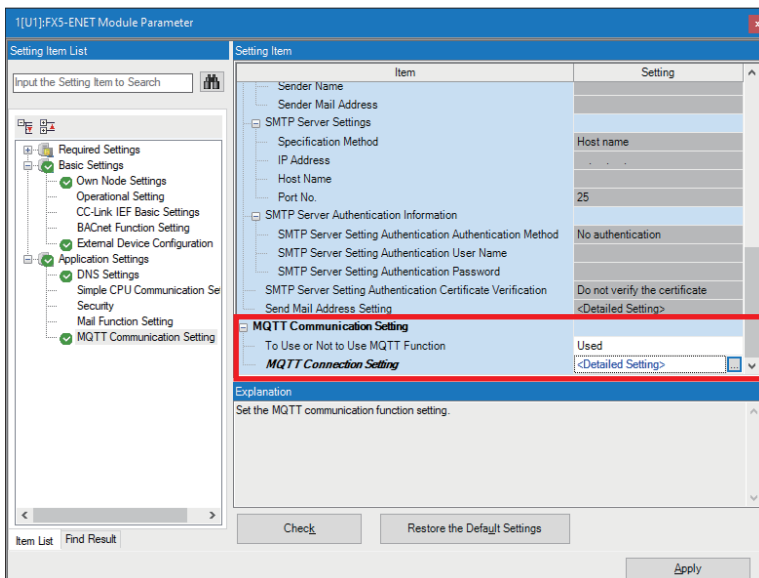

11. To avoid errors, temporarily enter arbitrary character strings for "MQTT Server Host Name" and "Client ID". Click the [Apply] button.

Configure the proper settings at the following timing.

☞ Page 40 Configuring Settings with GX Works3

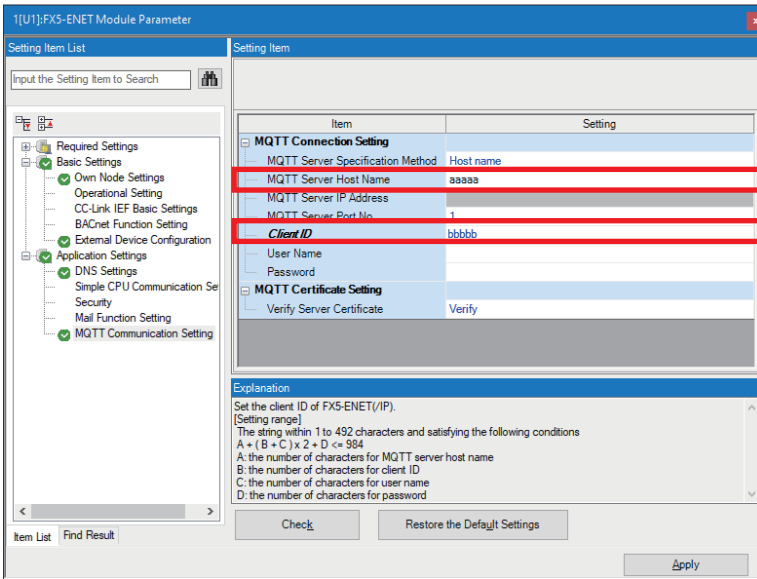

Configuring communication settings with GX Works3

Directly connect the Ethernet ports as shown below. To execute the writing process, perform a communication test first.

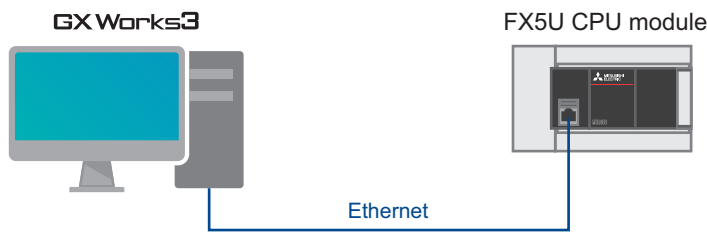

1. Select [Online] ⇒ [Current Connection Destination].

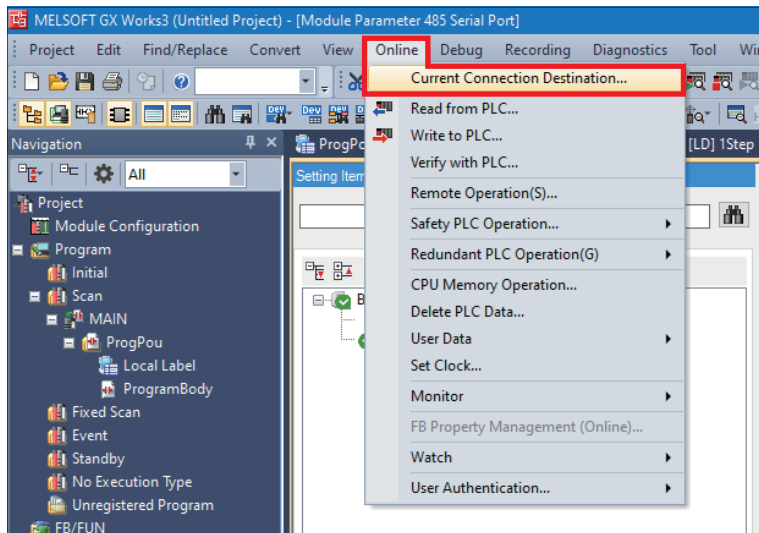

2. Select "Direct Coupled Setting".

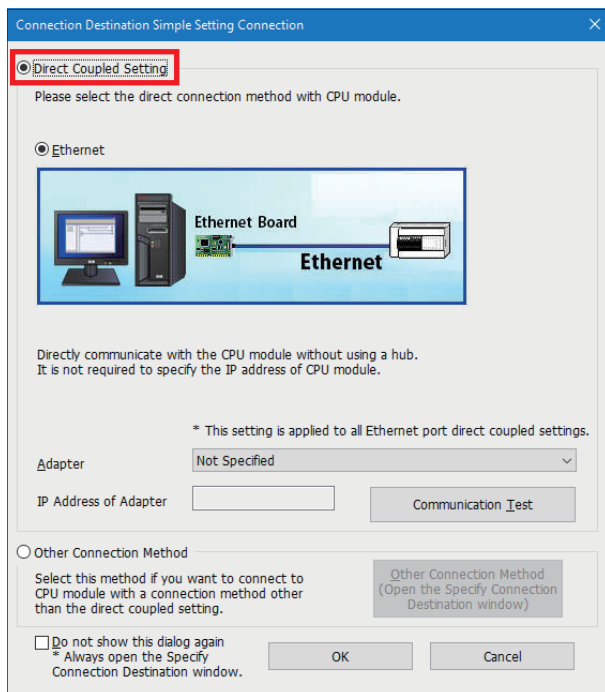

3. Specify an Ethernet adapter of the personal computer which is used when the personal computer is directly connected to the CPU module.

When [Not Specified] is set, select an adapter to be used from the drop-down list.

Connection Destination Simple Setting Connection

Direct Coupled Setting
Please select the direct connection method with CPU module.

Ethernet

Directly communicate with the CPU module without using a hub.
It is not required to specify the IP address of CPU module.

* This setting is applied to all Ethernet port direct coupled settings.

Adapter: Not Specified (dropdown menu highlighted with a red box)

IP Address of Adapter: [Empty text box]

Communication Test

Other Connection Method
Select this method if you want to connect to CPU module with a connection method other than the direct coupled setting.

Other Connection Method (Open the Specify Connection Destination window)

Do not show this dialog again
* Always open the Specify Connection Destination window.

OK Cancel

4. After the adapter is selected, click the [Communication Test] button.

Connection Destination Simple Setting Connection

Direct Coupled Setting
Please select the direct connection method with CPU module.

Ethernet

Directly communicate with the CPU module without using a hub.
It is not required to specify the IP address of CPU module.

* This setting is applied to all Ethernet port direct coupled settings.

Adapter: Ethernet Adapter (Communication via CPU Module) (dropdown menu highlighted with a red box)

IP Address of Adapter: 10.97.219.90

Communication Test (button highlighted with a red box)

Other Connection Method
Select this method if you want to connect to CPU module with a connection method other than the direct coupled setting.

Other Connection Method (Open the Specify Connection Destination window)

Do not show this dialog again
* Always open the Specify Connection Destination window.

OK Cancel

For the connection via a hub, refer to the following.

📖 MELSEC iQ-F FX5 User's Manual (Communication), Section 4.2 Connection via a Hub

Writing data to the programmable controller

Write the program to the FX5U CPU module.

The operation to determine the programs and the parameters is required before writing them to the programmable controller.

1. Select [Convert] ⇒ [Rebuild All].

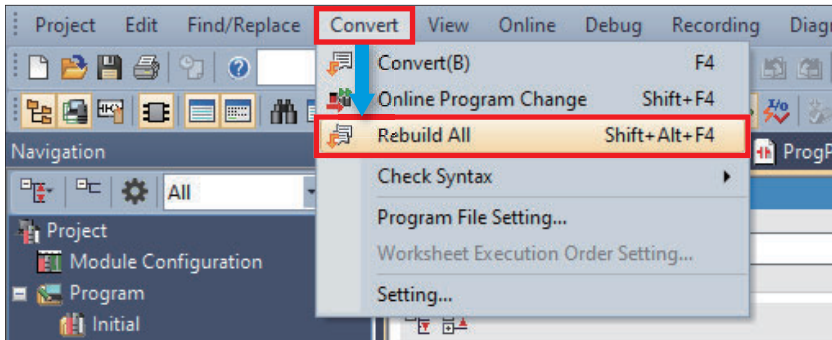

2. Click the [OK] button.

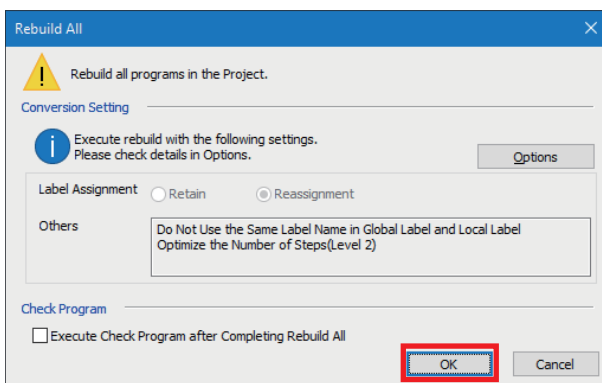

3. Select [Online] ⇒ [Set Clock].

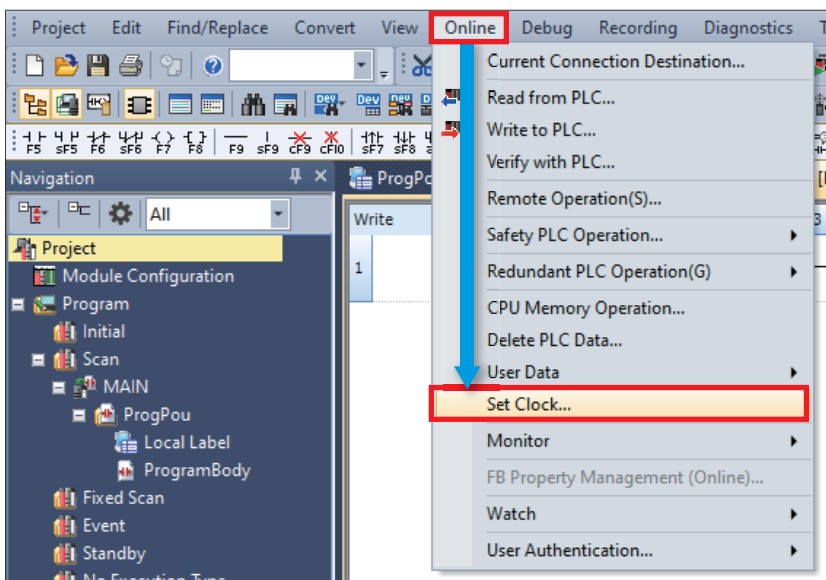

4. Configure the following settings and click the [Execute] button.

For the setting details, refer to the following.

 GX Works3 Operating Manual

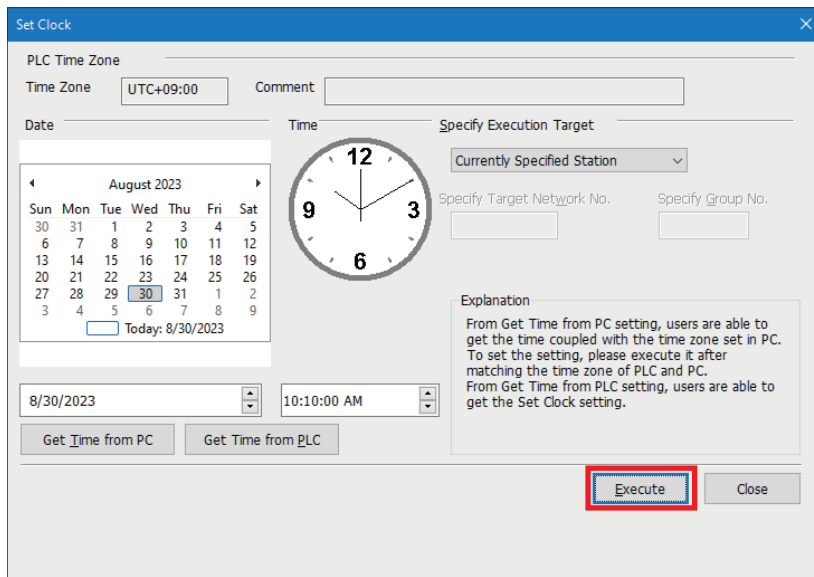

5. Select [Online] ⇒ [Write to PLC].

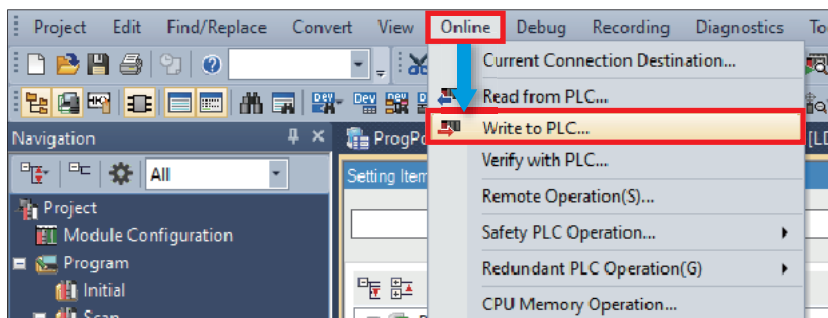

6. Click [Parameter + Program], and click [Execute].

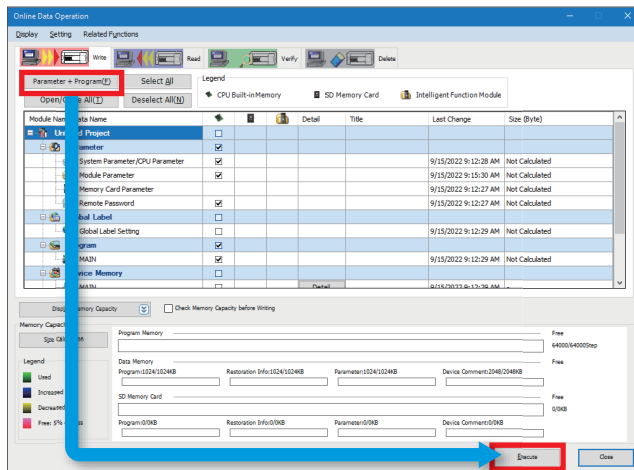

7. When the following window appears, click [Yes to all].

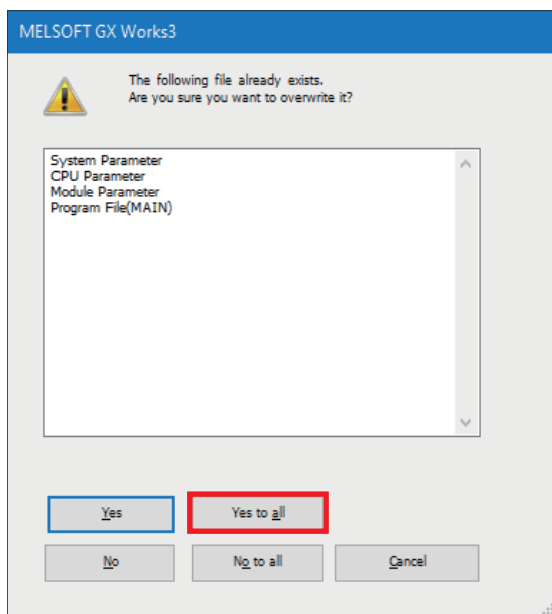

8. After the writing is complete, reset (or power off and on) the FX5U CPU module.

3.2 Configuring Settings with Certificate Configuration Tool for FX5-ENET

Start Certificate Configuration Tool for FX5-ENET, set the certificate, and perform the writing process.

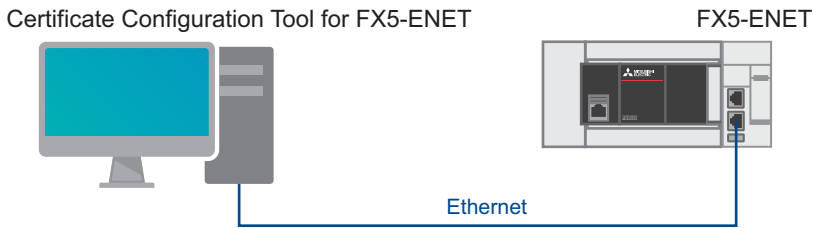

3

Point

Because the settings cannot be written to the FX5-ENET with the connection of a personal computer and an FX5U CPU module, connect a personal computer and the FX5-ENET with an Ethernet cable.

1. Select [Tool] ⇒ [Module Tool List] ⇒ [Information Module] ⇒ [Certificate Configuration Tool] of GX Works3 and click the [OK] button to start Certificate Configuration Tool for FX5-ENET.

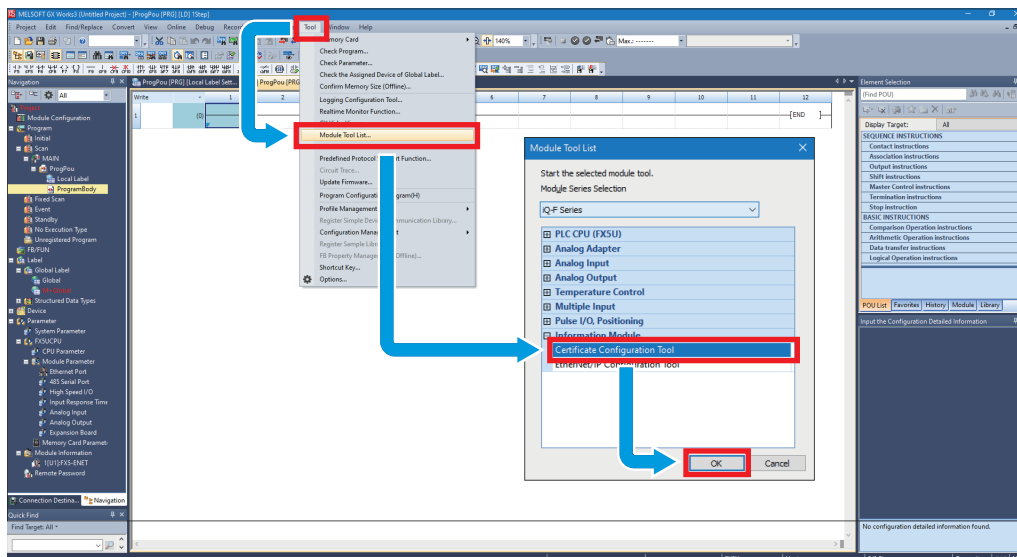

2. Select [Connection Settings]. Enter the IP address of the FX5-ENET in [Host (IP Address)] and click the [Communication Test] button.

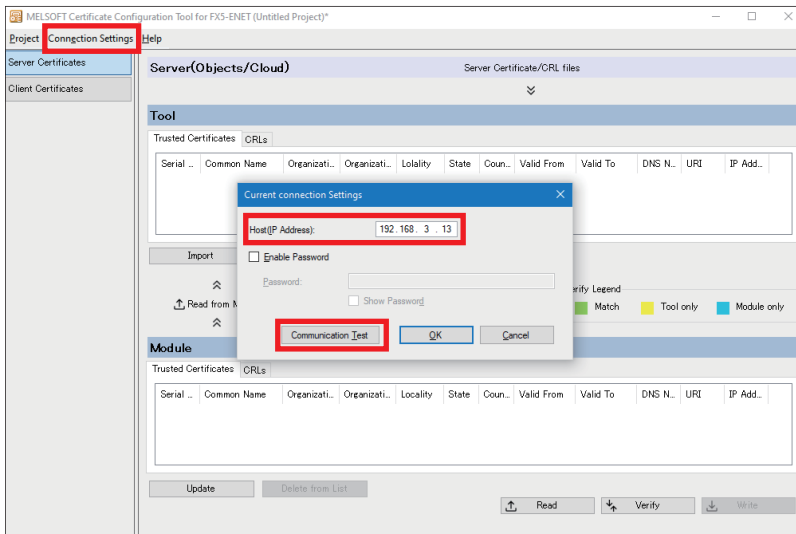

Point

- If a firewall is set up between the FX5-ENET and the personal computer, the communication test will fail. In this case, permission must be given to a port to be used, so check the firewall settings.
- The IP address of the personal computer must be set to the same segment as the FX5-ENET, so review the IP address settings.

3. Select [Client Certificates] and click the [Generate a New Client Certificate] button. Configure the settings as shown below, and click the [Generate] button.

The set common name is used when issuing certificates in AWS.

☞ Page 32 Creating a certificate

Item	Setting
Common Name *1	Any name
Country	US
RSA Key Strength	2048 bits

*1 Set a common name that is not a duplicate.

(This is the restriction at the time of the publication of this manual. For the latest information on the restriction, check the website of AWS.)

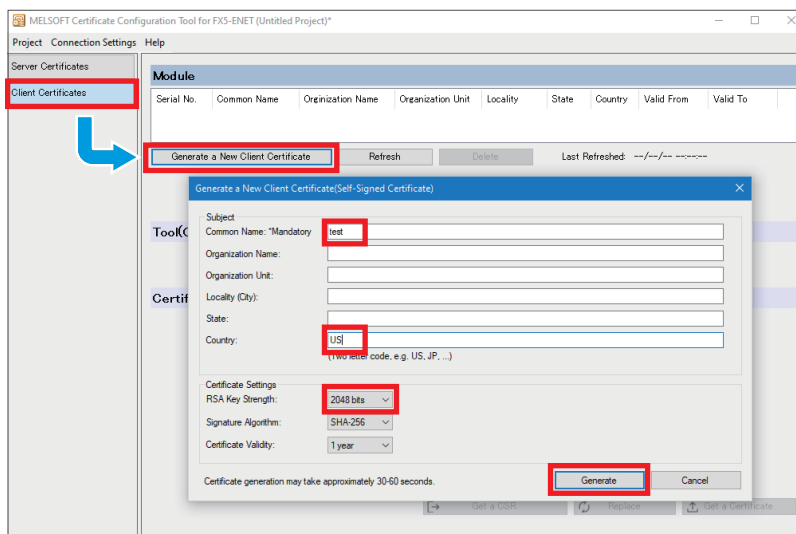

4. Click the [Yes] button.

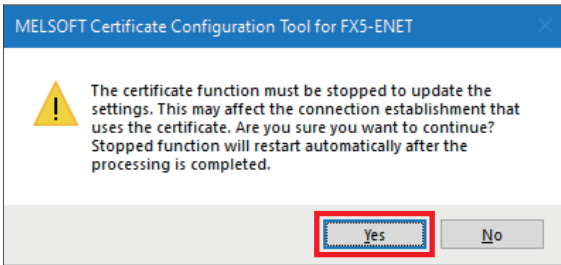

5. When generation is completed, click the [Get a CSR] button, name the CSR file, and save it. The saved CSR file is used when issuing certificates in AWS.

Page 32 Creating a certificate

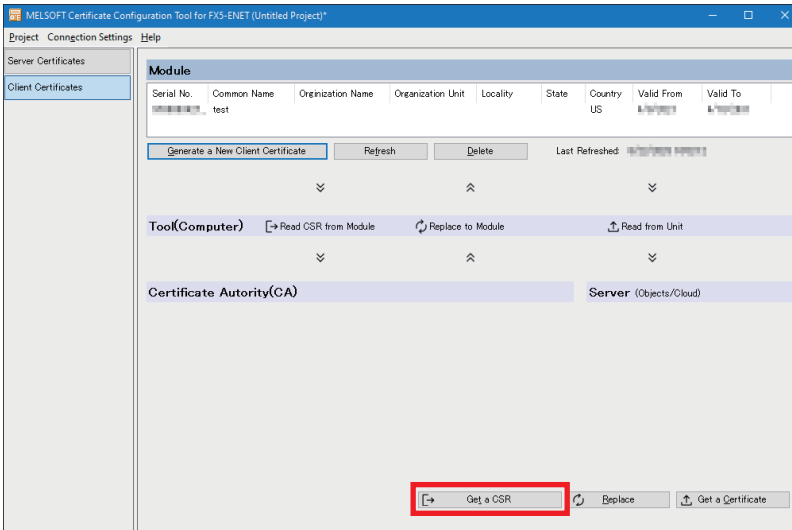

4 CONFIGURING SERVER (MQTT BROKER) CONNECTION

This chapter describes the setting items for the server (MQTT broker).

4.1 Configuring Settings with AWS

Configure the server (MQTT broker) for connecting to AWS.

Point

Configure the server (MQTT broker) while signed in to AWS Management Console. Prepare your account ID, user name, password, and IAM user in advance.

Sign-in

1. Access the following URL with a web browser. (Click the [Log back in] button to sign in.)

https://aws.amazon.com/console/?nc1=h_ls

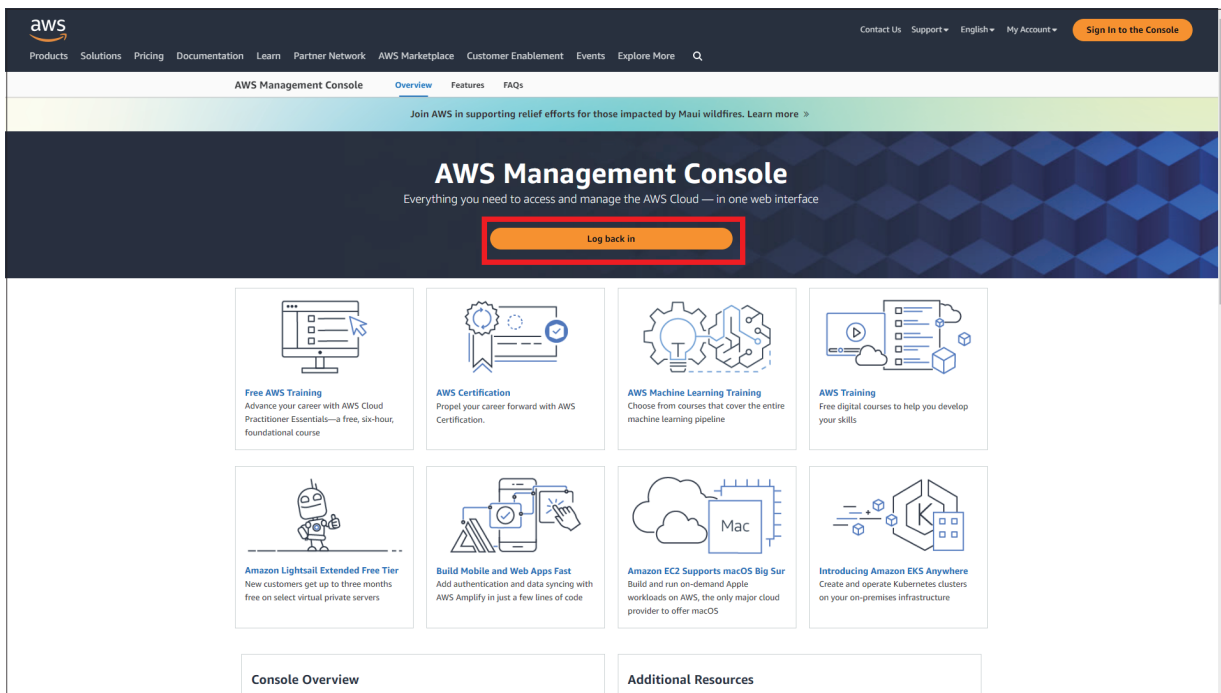

Configuring settings with AWS IoT services

Configure the AWS IoT services to be used with AWS connection.

The settings required for MQTT communication between the FX5-ENET and AWS IoT services are as follows.

- Policies
- Things
- Certificates

1. On the top left, select [Services] ⇒ [Internet of Things] ⇒ [IoT Core].

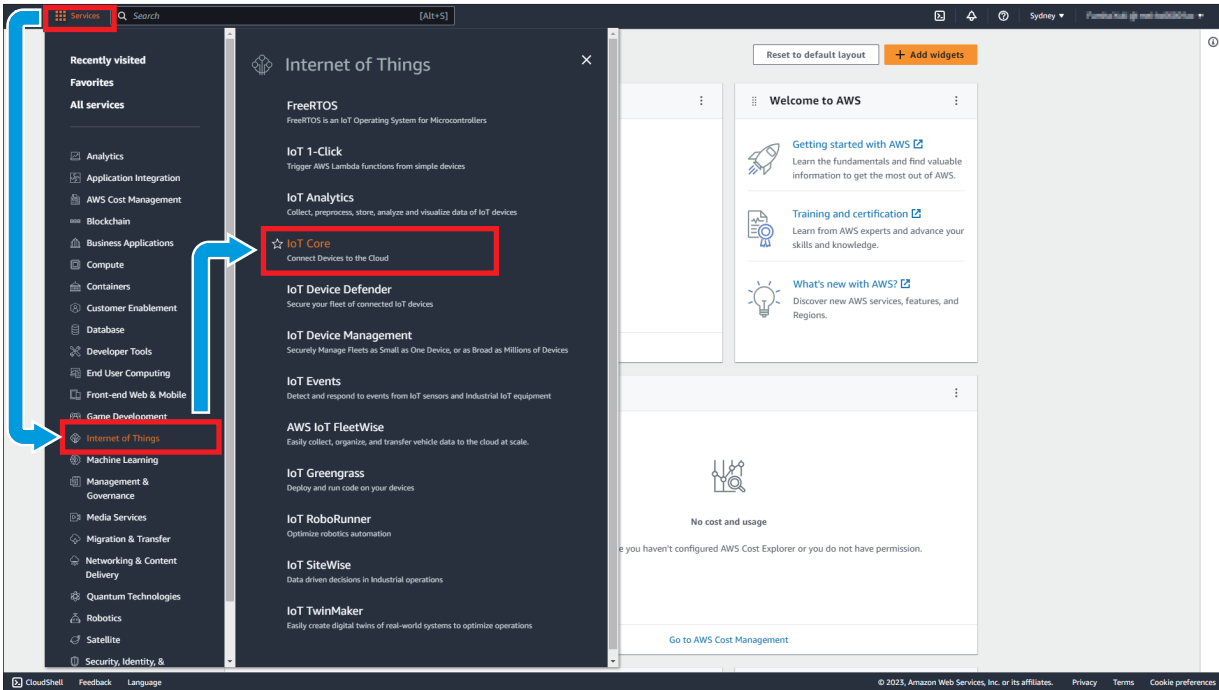

Creating a policy

A policy manages which operations to be allowed for things.

Configure detailed settings for MQTT communication by associating things and certificates.

1. Select [Security] ⇒ [Policies] from the left menu and click the [Create policy] button.

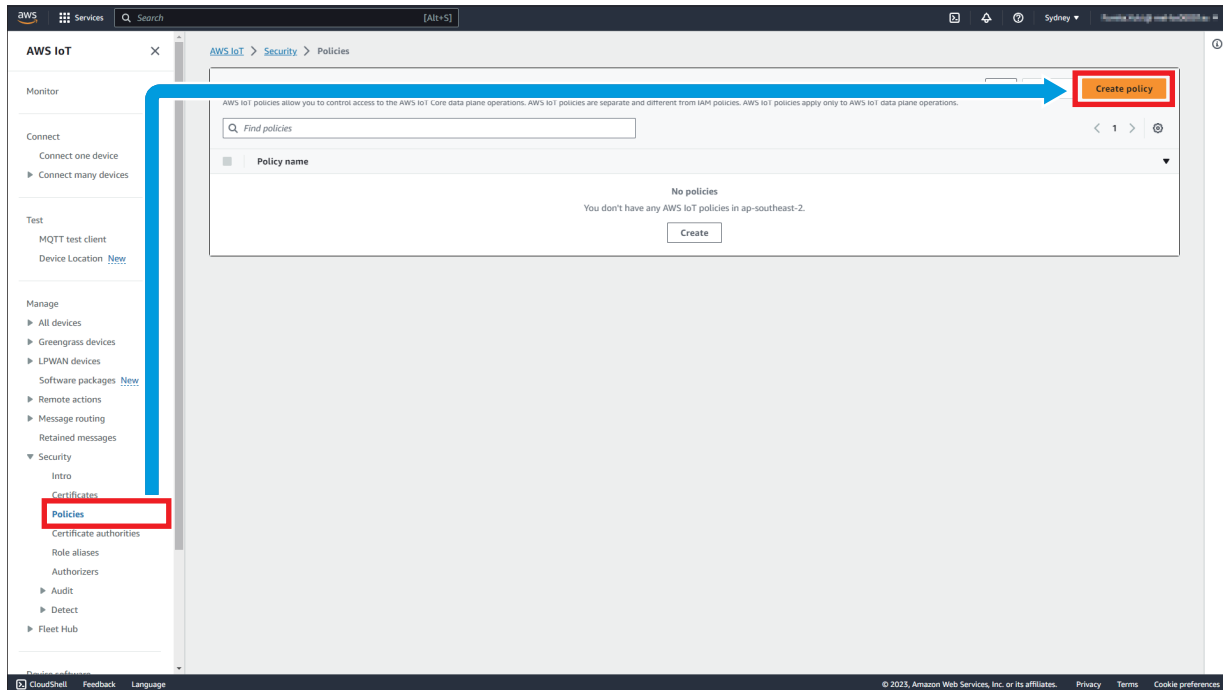

2. Configure settings as shown below, and click the [Create] button.

Item	Setting
Policy name	Any name
Policy effect	Allow
Policy action ^{*1}	*
Policy resource ^{*1}	*

^{*1} This item describes the policy settings for testing. For actual use, configure settings with restrictions.

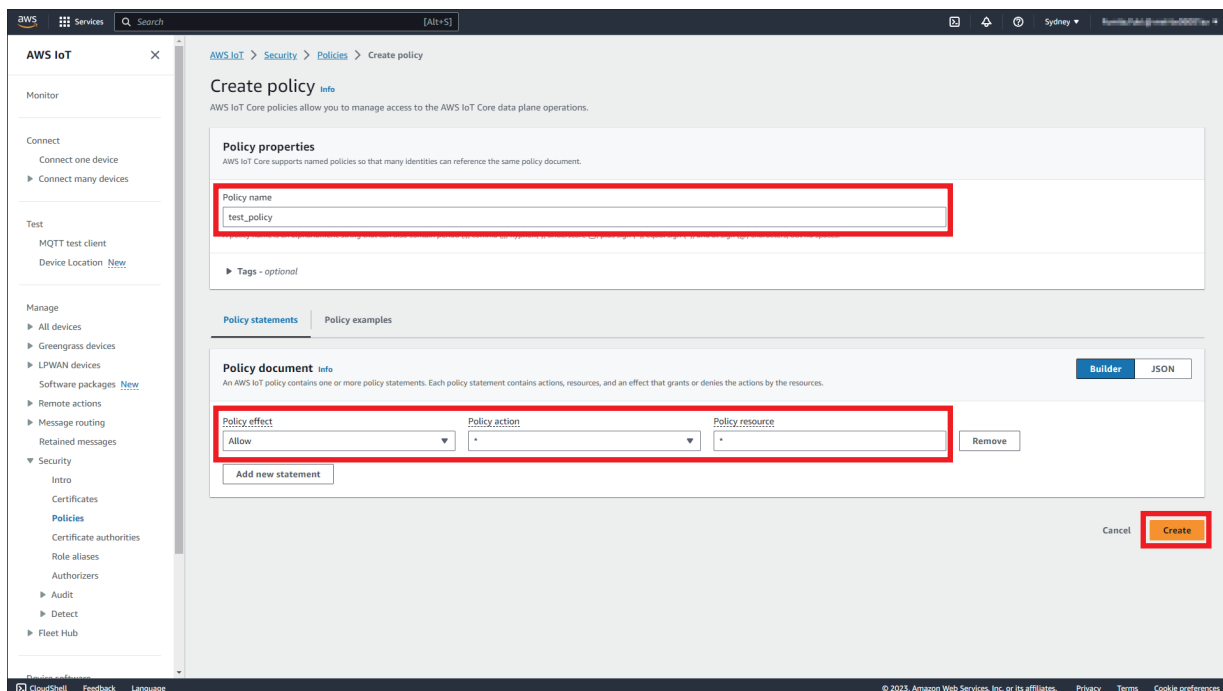

3. The policy is added to the list.

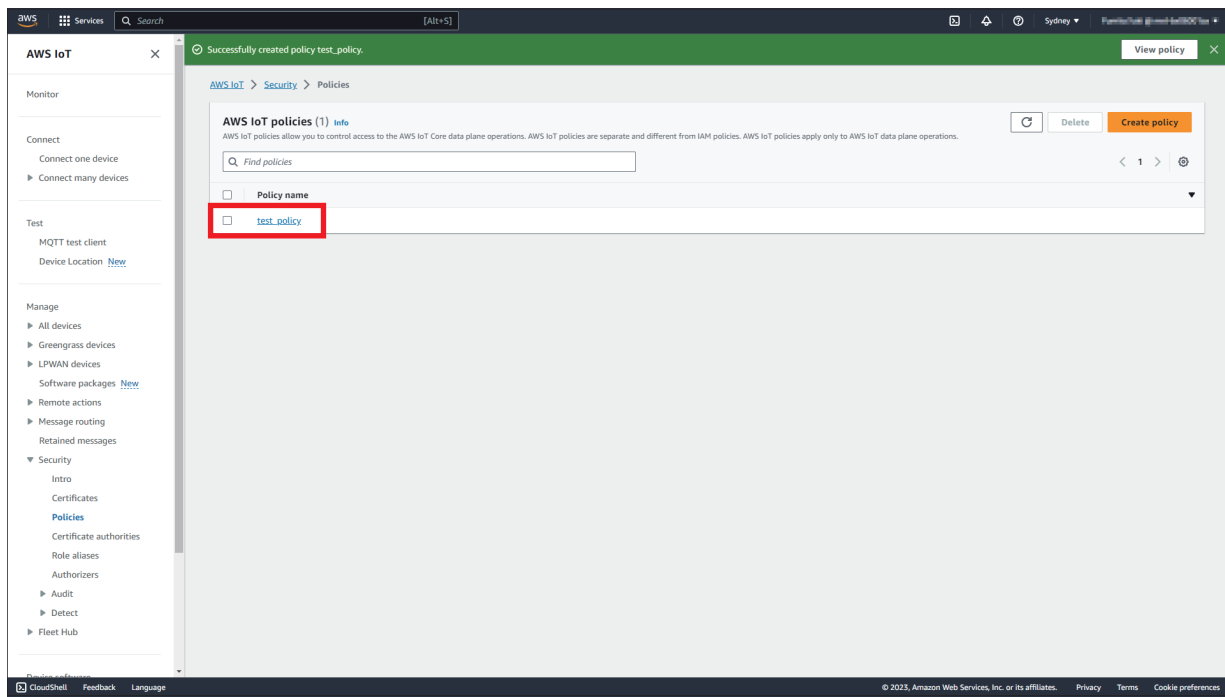

4

Creating AWS IoT things

A thing is an object that connects to the Internet. In this manual, this refers to the FX5-ENET.

1. Select [Manage] ⇒ [All devices] ⇒ [Things] from the left menu, and click the [Create things] button.

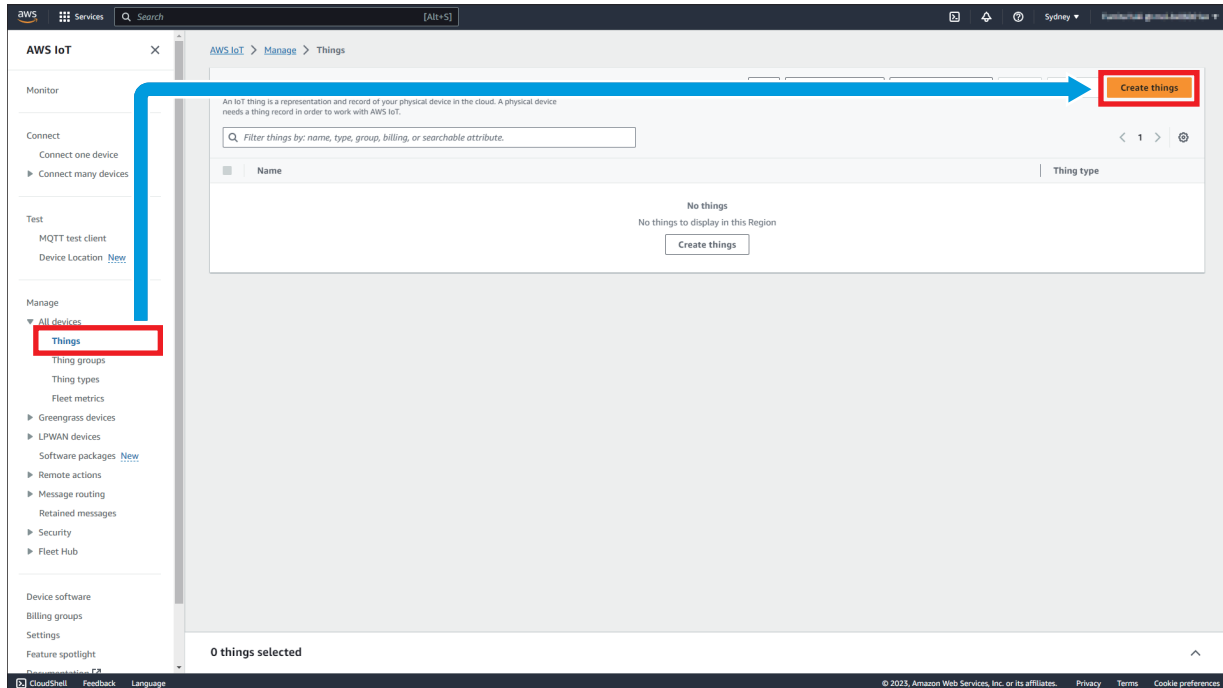

2. Select [Create single thing] and click the [Next] button.

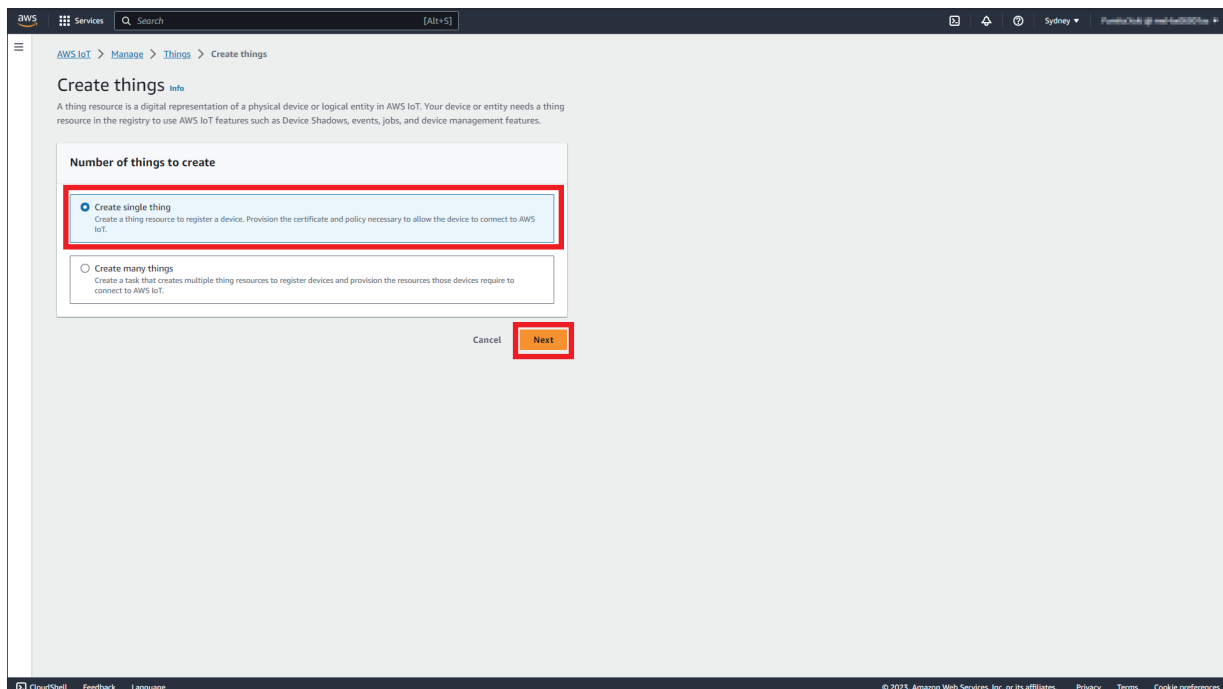

3. Configure settings as shown below, and click the [Next] button.

Item	Setting
Thing name	Any name
Device Shadow	No shadow

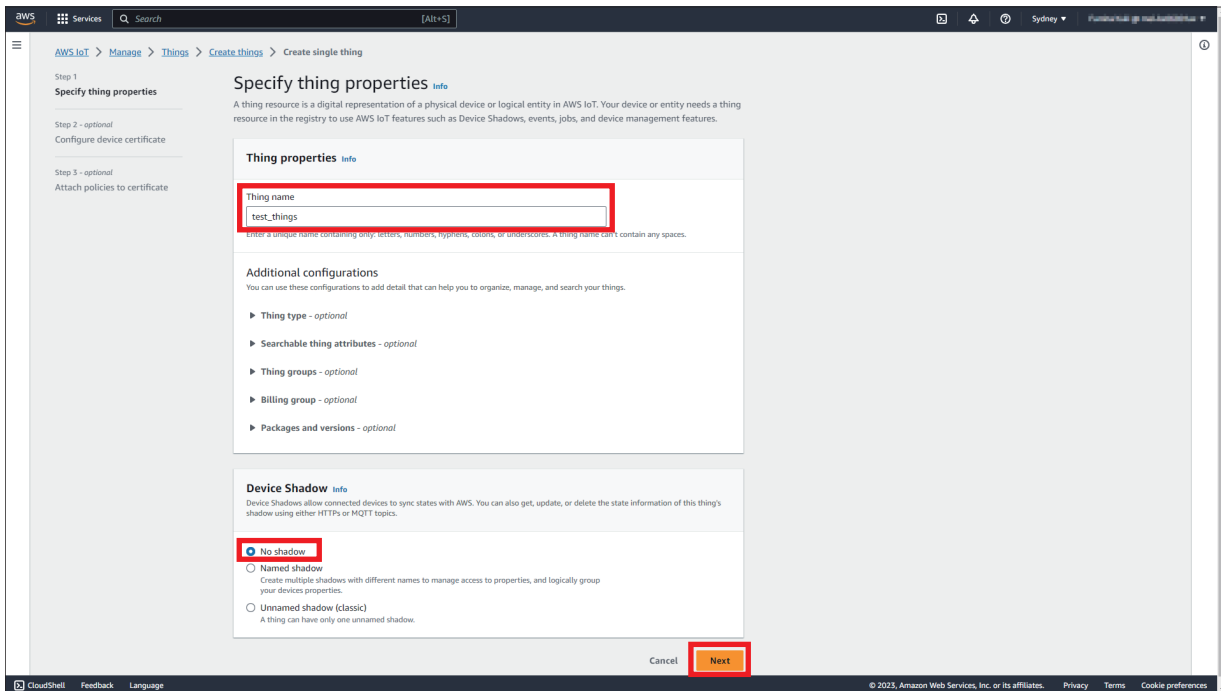

4

4. Select [Skip creating a certificate at this time] and click the [Create thing] button.

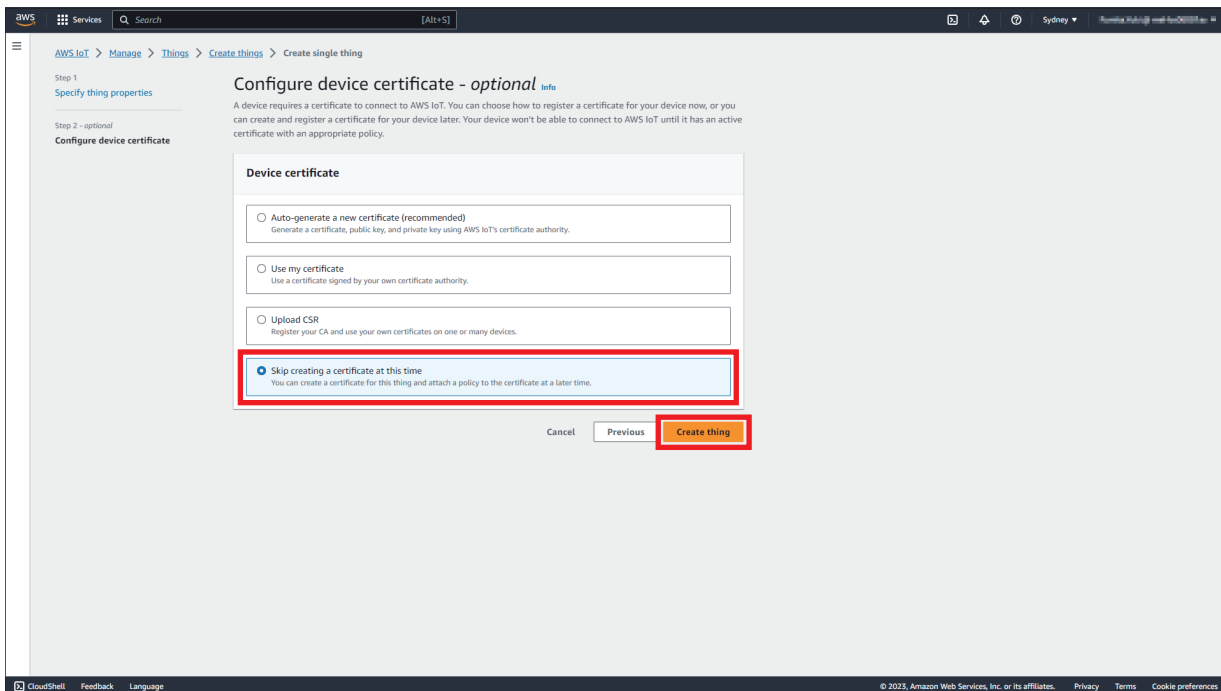

5. The thing is added to the list.

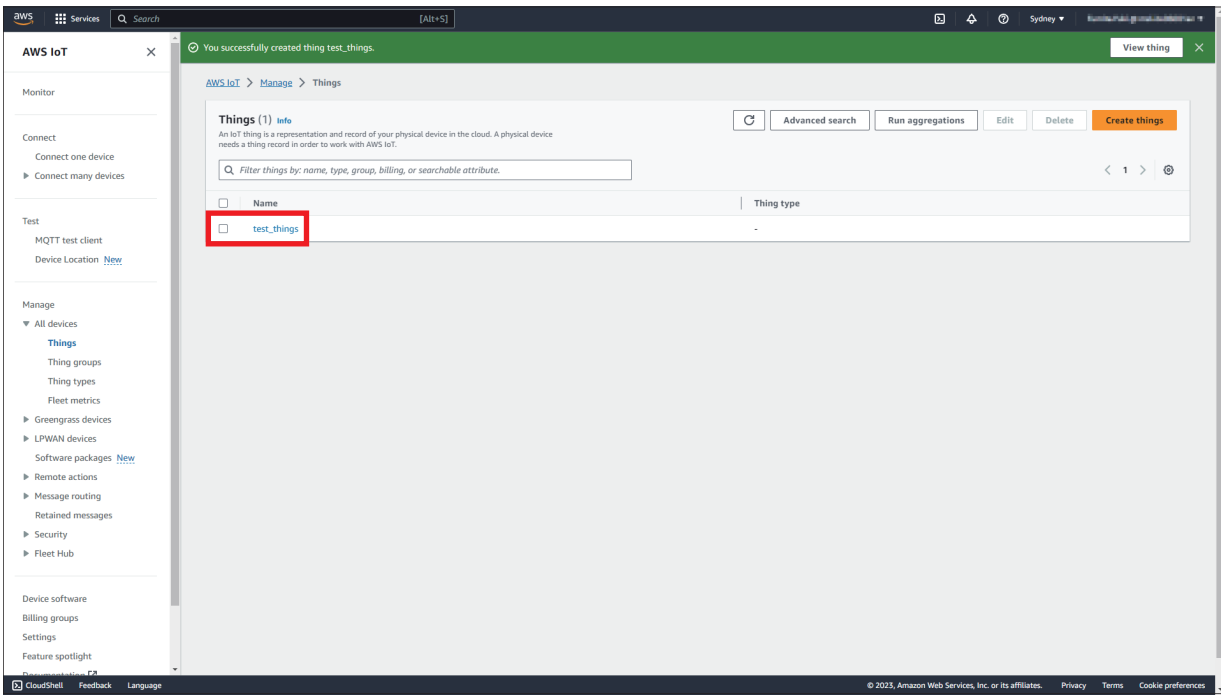

Creating a certificate

A certificate authenticates the connection between a device and a client. To enable a device or client to communicate with AWS IoT, a certificate must be registered and activated with AWS IoT.

1. Select [Security] ⇒ [Certificates] from the left menu and click the [Create certificate] button.

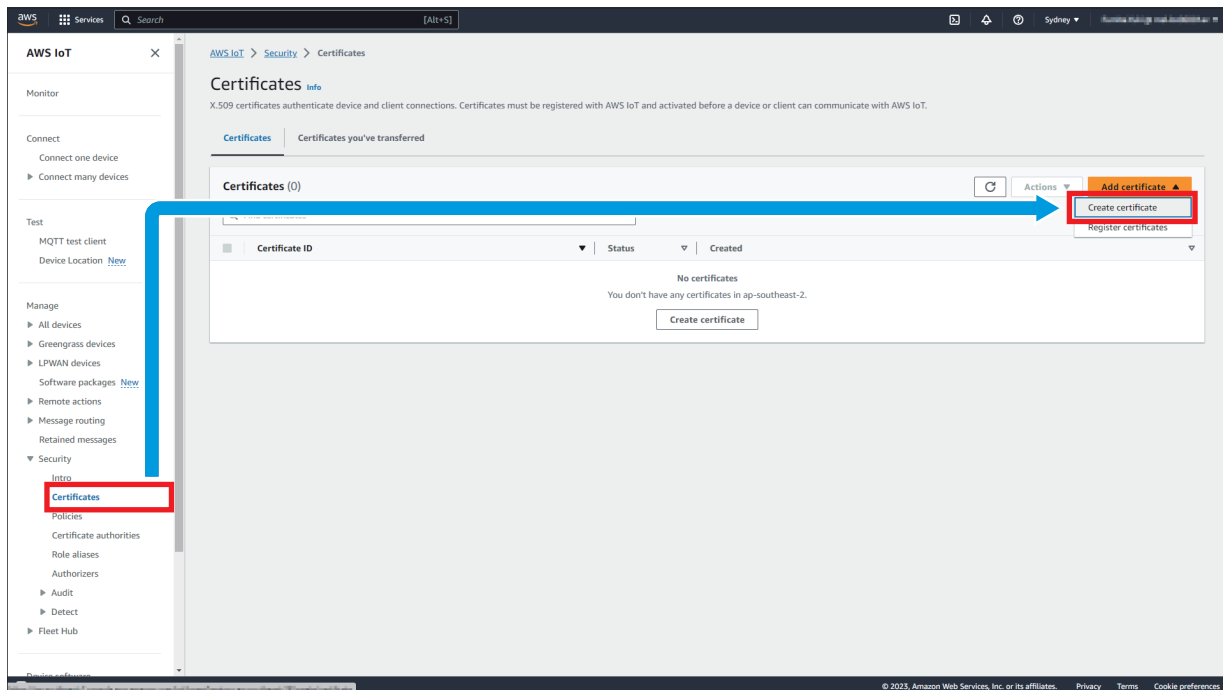

2. Select [Create certificate with certificate signing request (CSR)]. Select the CSR file generated by Certificate Configuration Tool for FX5-ENET from the [Choose file] button. (Page 22 Configuring Settings with Certificate Configuration Tool for FX5-ENET)
Select [Active] for the certificate status and click the [Create] button.

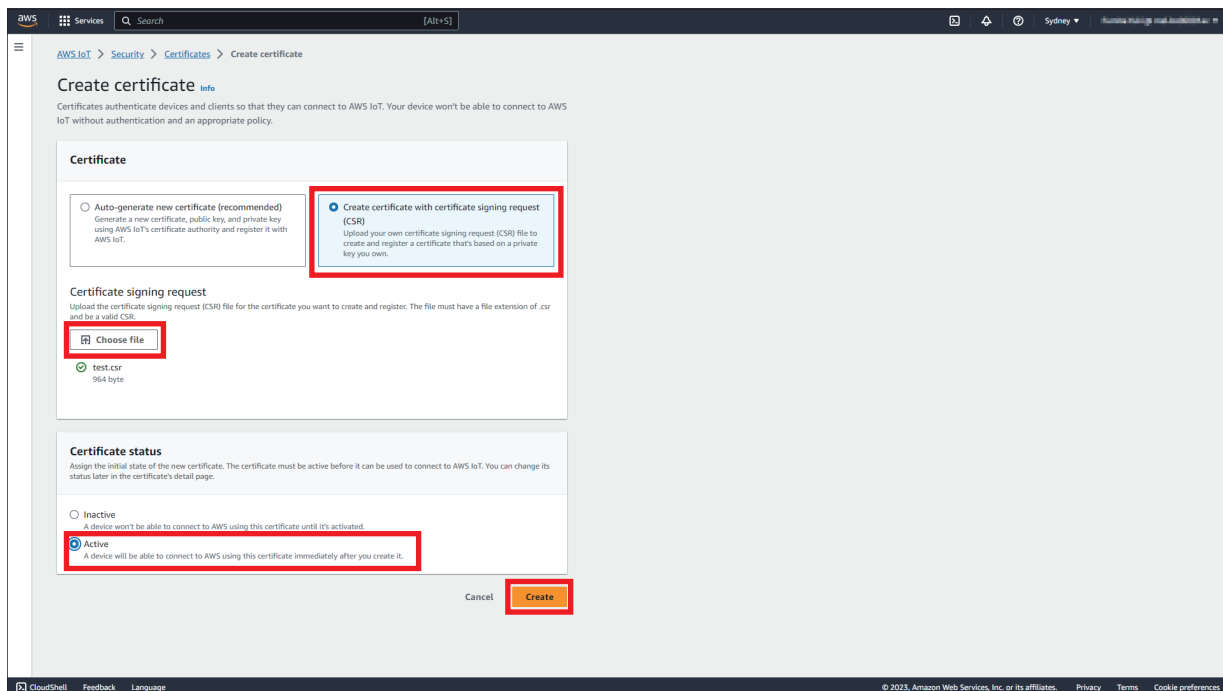

3. Download [Device certificate]. This certificate is required for writing to the FX5-ENET. (👉 Page 37 Writing a certificate)
When downloading is completed, click the [Continue] button.

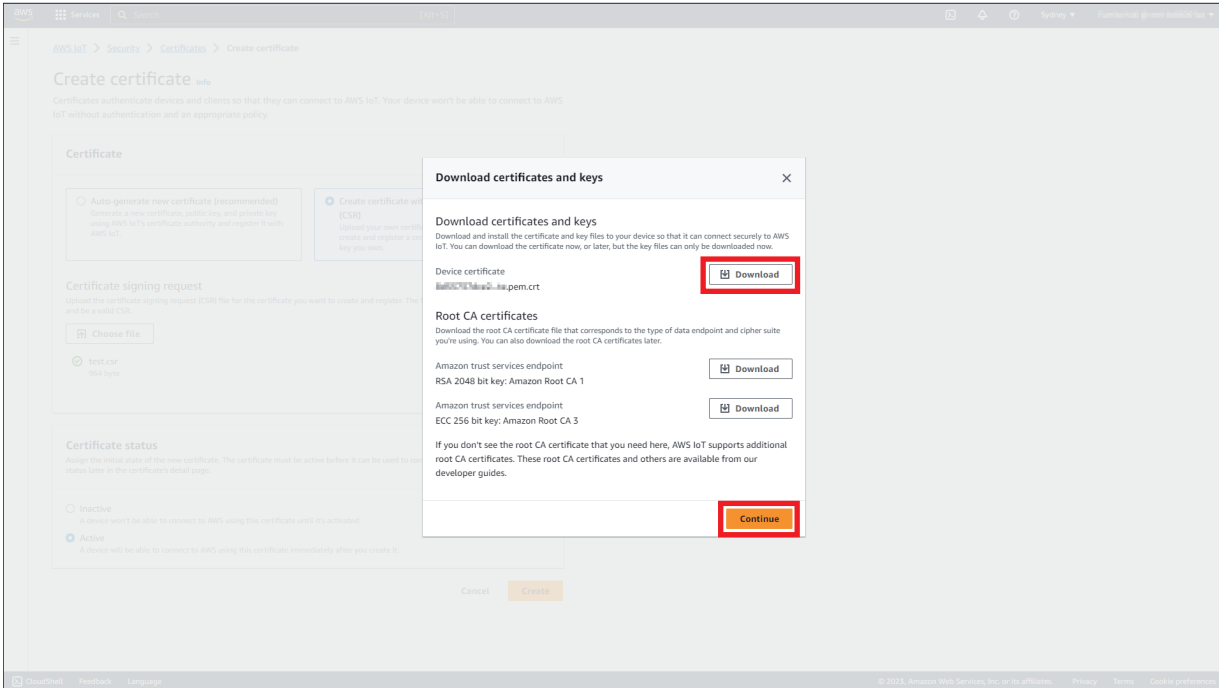

4. The certificate is added to the list. Click the certificate ID created now.

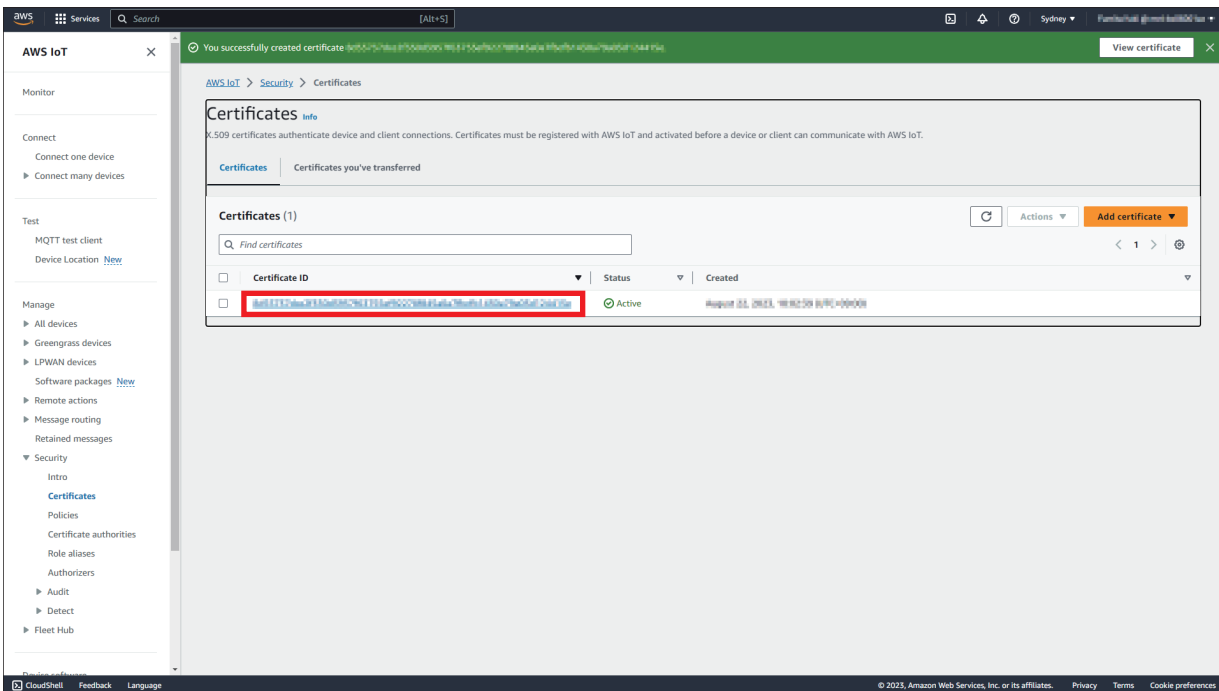

5. Click the [Attach policies] button in [Policies].

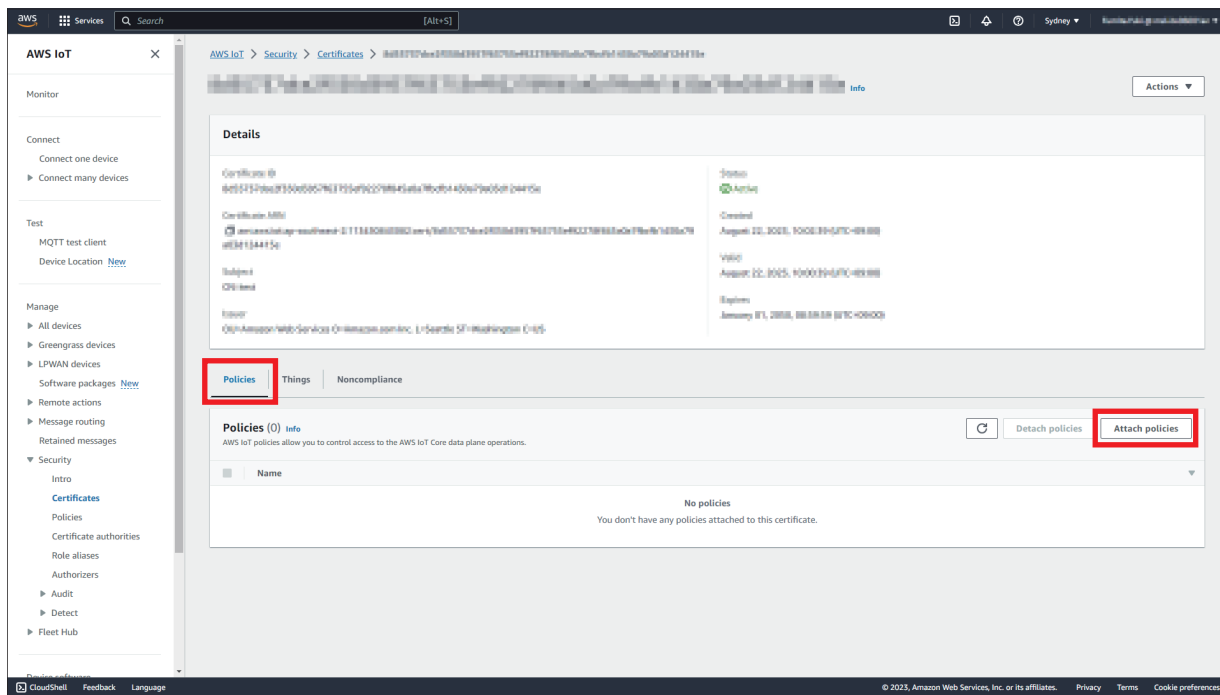

4

6. Select the created policy name and click the [Attach policies] button.

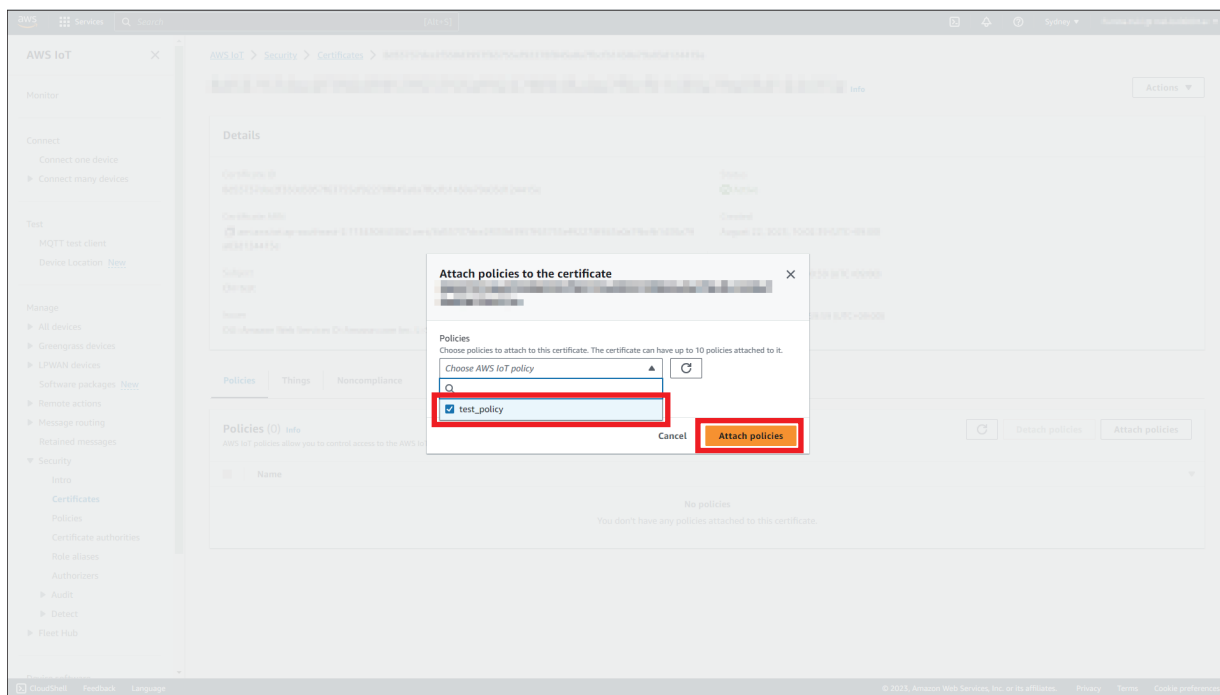

7. Click the [Attach to things] button in [Things].

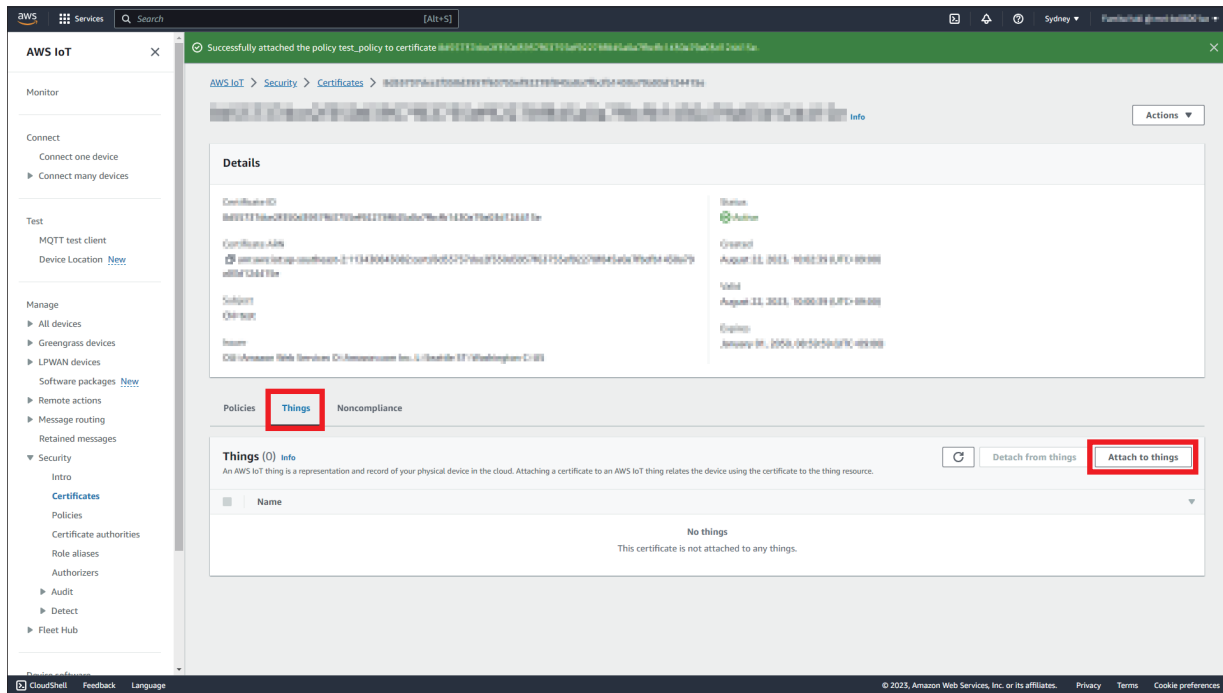

8. Select the name of the created thing, and click the [Attach to thing] button.

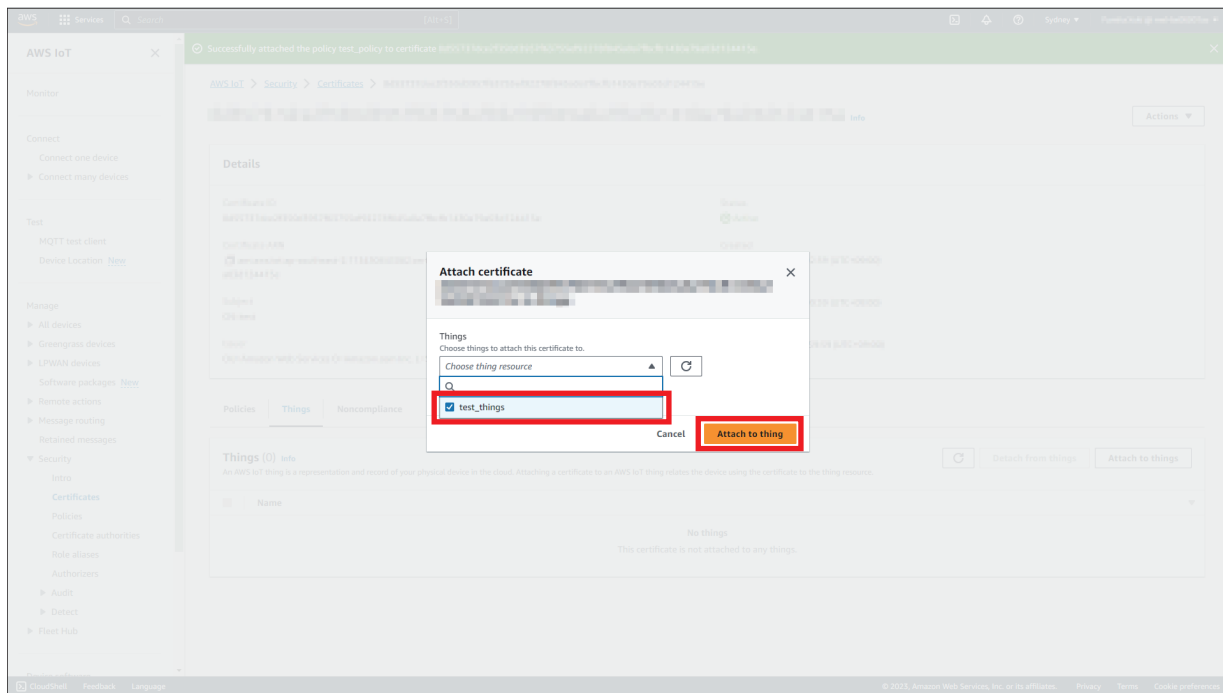

4.2 Configuring Settings with Certificate Configuration Tool for FX5-ENET

Writing a certificate

1. In Certificate Configuration Tool for FX5-ENET, click [Client Certificates] ⇒ [Replace] button.

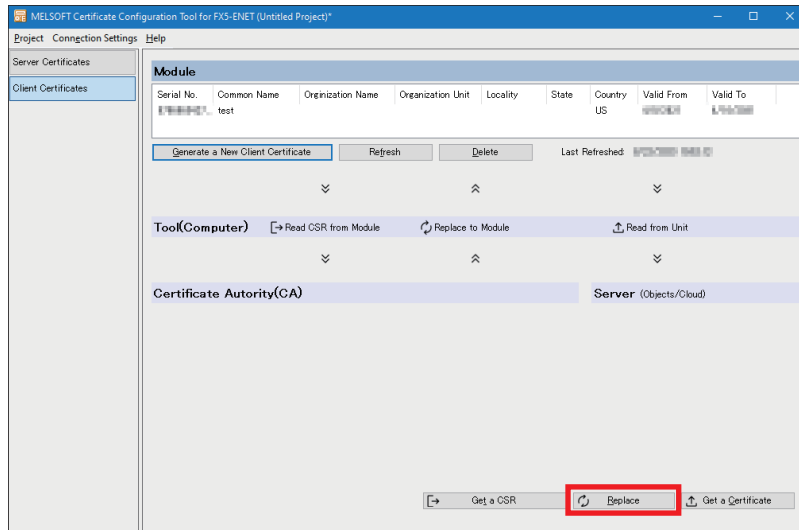

2. Click the [Yes] button.

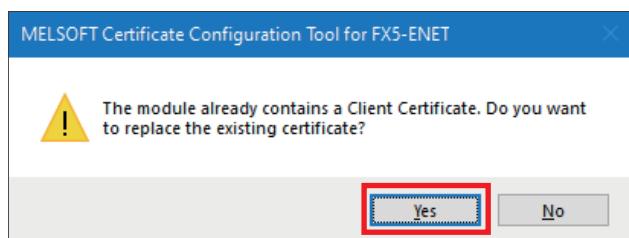

3. Select the certificate (*.crt) downloaded in [Page 32 Creating a certificate](#) and import the certificate.

Point

If the certificate (*.crt) is not displayed, delete the end of the file name (.crt). (The extension will become .pem.)

4. Click the [Yes] button.

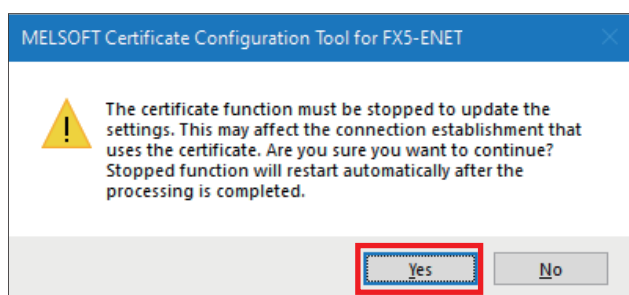

6. In Certificate Configuration Tool for FX5-ENET, select [Server Certificates] ⇒ [Import] button to import the server certificate (sf-class2-root.crt).

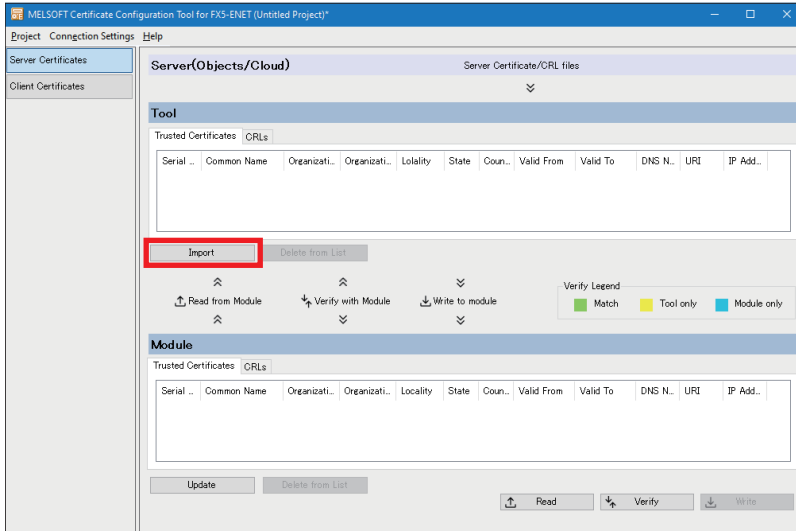

7. When the file has normally been imported, click the [Write] button to write it to the FX5-ENET.

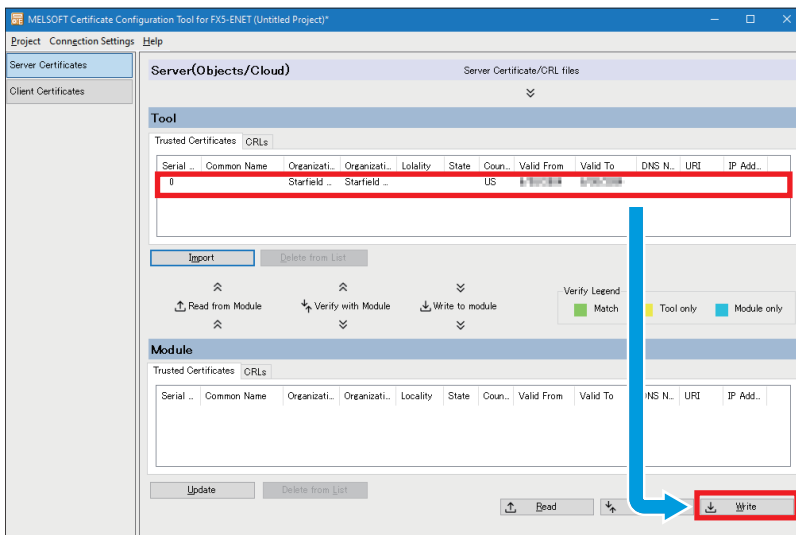

8. Click the [Yes] button.

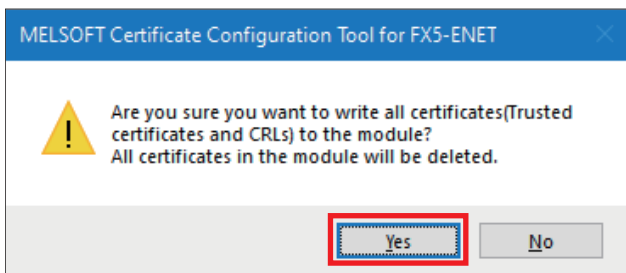

9. Click the [Yes] button.

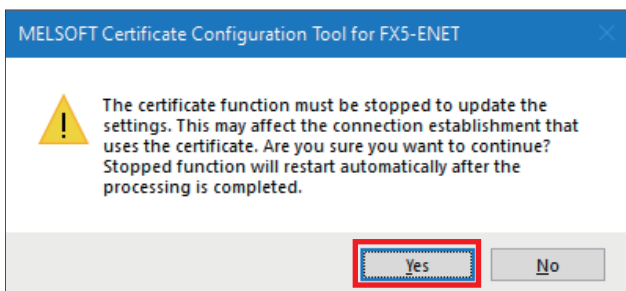

4.3 Configuring Settings with GX Works3

1. Select the "Navigation" window ⇒ [Parameter] ⇒ [Module Information] ⇒ [FX5-ENET] ⇒ [Application Settings] ⇒ [MQTT Communication Setting] ⇒ [MQTT Connection Setting] and double-click <Detailed Setting>.
2. Configure the following settings and click the [Apply] button.

Item	Setting
MQTT Server Specification Method	Host name
MQTT Server Host Name	*****.amazonaws.com (own endpoint) Enter the endpoint that was copied in the section below. ☞ Page 36 Checking an endpoint
MQTT Server Port No.	8883
Client ID	test_things Enter the name of the thing that was created in the section below. ☞ Page 29 Creating AWS IoT things
Verify Server Certificate	Verify

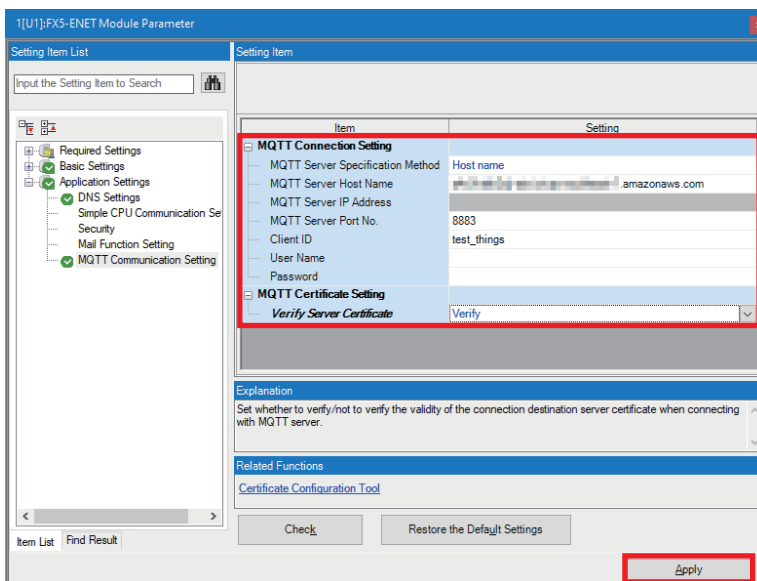

3. Configuring the settings with GX Works3 is completed by creating a program and writing it to the programmable controller.

☞ Page 41 CHECKING OPERATIONS

☞ Page 19 Writing data to the programmable controller

5 CHECKING OPERATIONS

Based on the system configuration (☞ Page 9 System Configuration), write the program to the FX5U CPU module and check the operation.

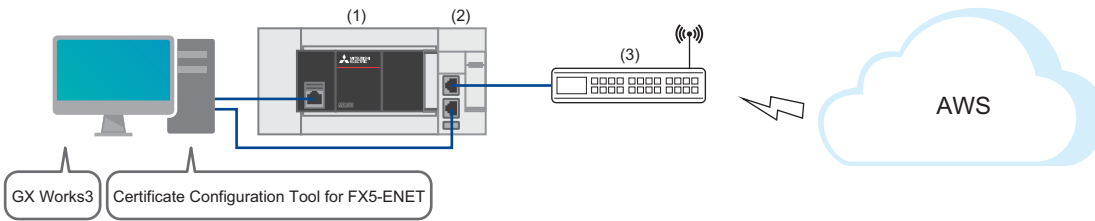

- (1) FX5U CPU module
- (2) FX5-ENET
- (3) Router

5.1 Checking the Operation of Connect (MQTT Connection Establishment)

Use M+FX5ENET_MQTT_Connect (MQTT connection establishment) for controlling the connection with the server (MQTT broker).

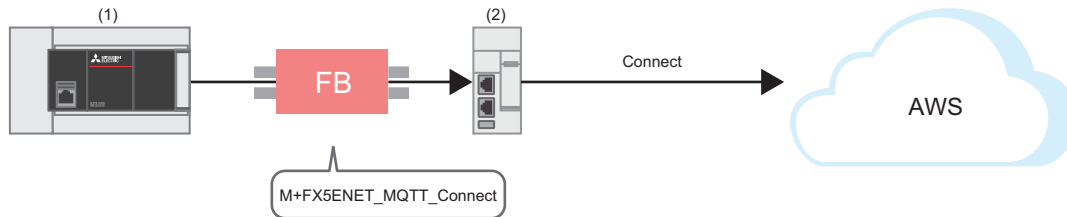

- (1) FX5U CPU module
- (2) FX5-ENET

Program

M12 turns on for setting the information used for M+ENET_MQTT_Connect (MQTT connection establishment).

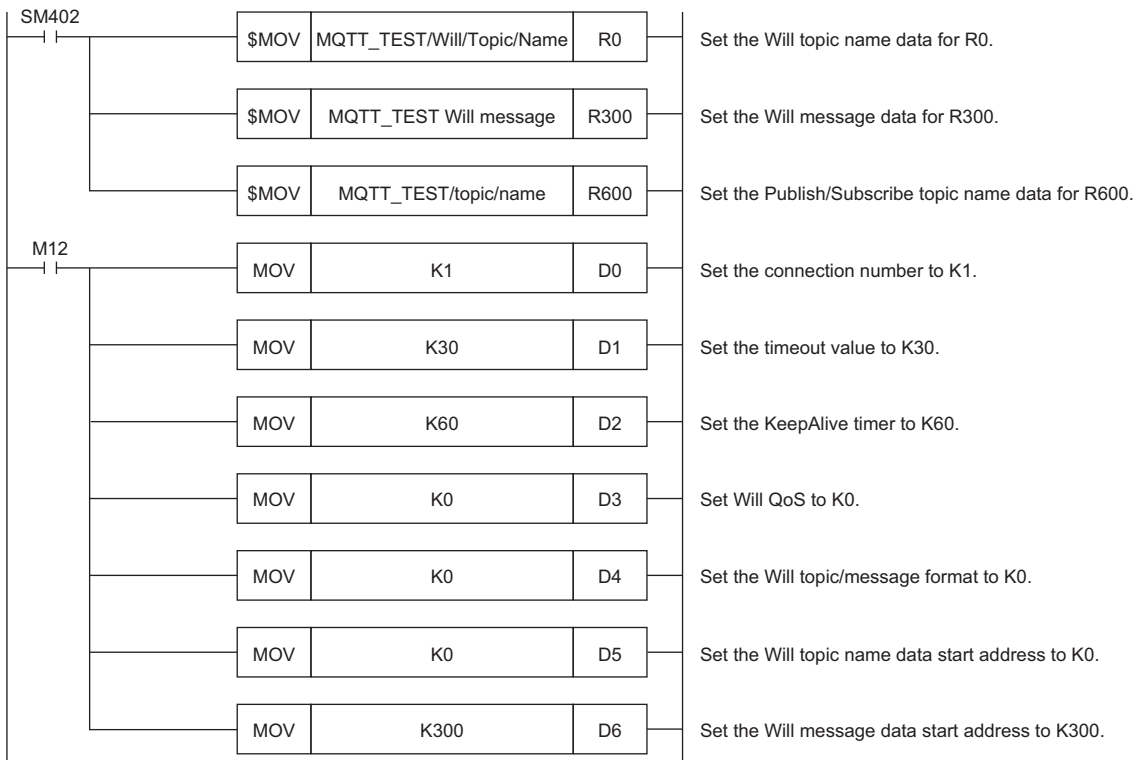

After M4 (Enable Will) turns on, M0 turns on. When FX5ENET_1.uSts_CertFuncReadyStatus_D (Certificate function ready-to-enable state) turns on, M14 (Execution command) turns on. M1 (CONNECT instruction) subsequently turns on to establish the connection.

When the connection is successfully established, M9 (Establishment completion) turns on.

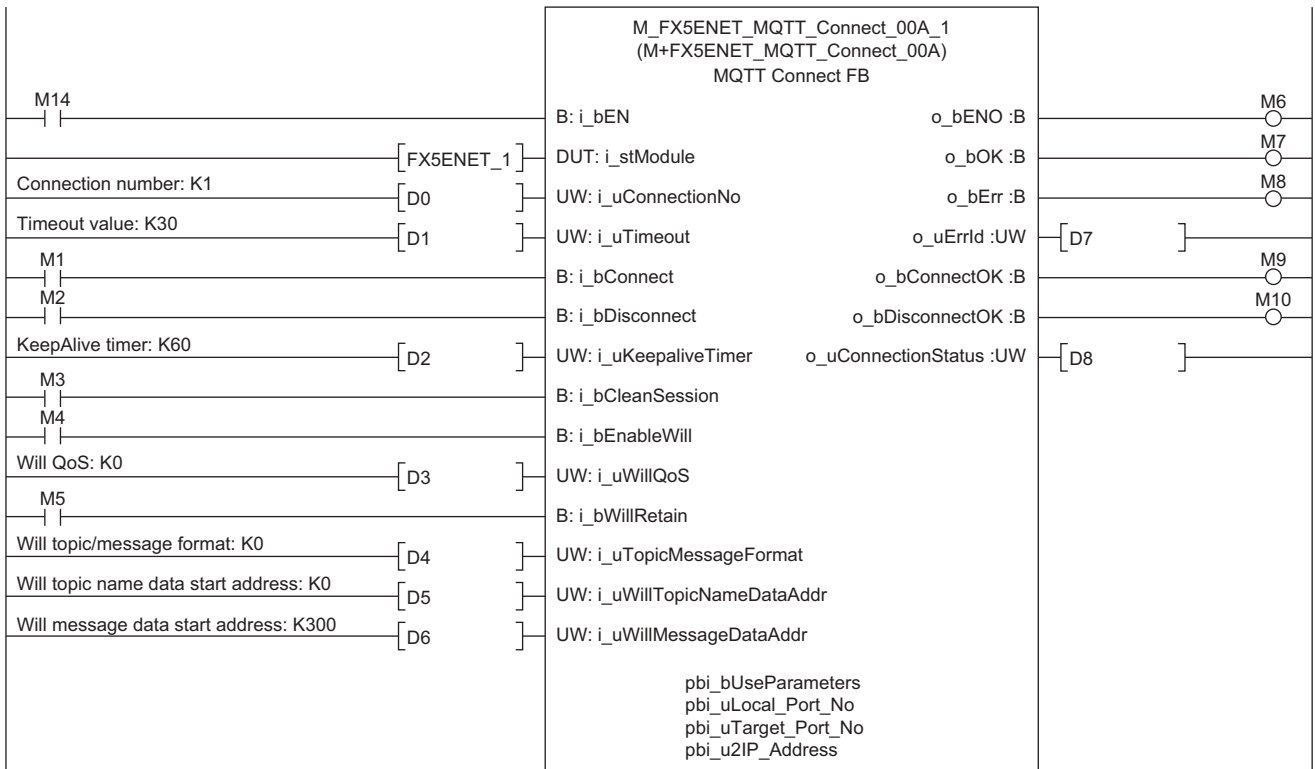
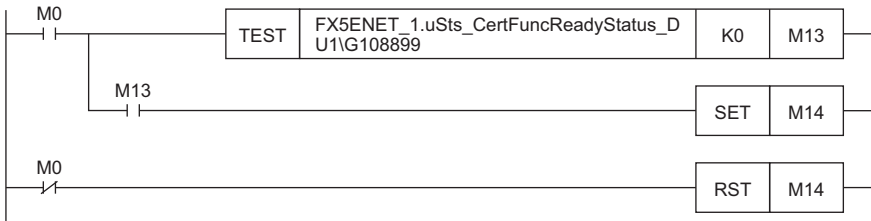

5.2 Checking the Operation of Subscribe (Sending of Subscribe Command)

Use M+FX5ENET_MQTT_Subscribe (Sending of Subscribe command) for sending a SUBSCRIBE/UNSUBSCRIBE command to the server (MQTT broker).

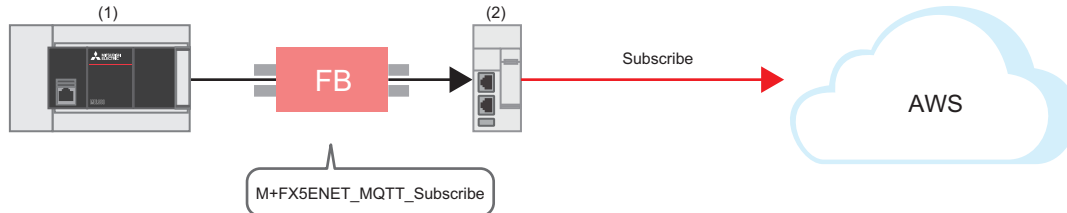

- (1) FX5U CPU module
- (2) FX5-ENET

Program

M27 turns on for setting the information used for M+ENET_MQTT_Subscribe (Sending of Subscribe command).

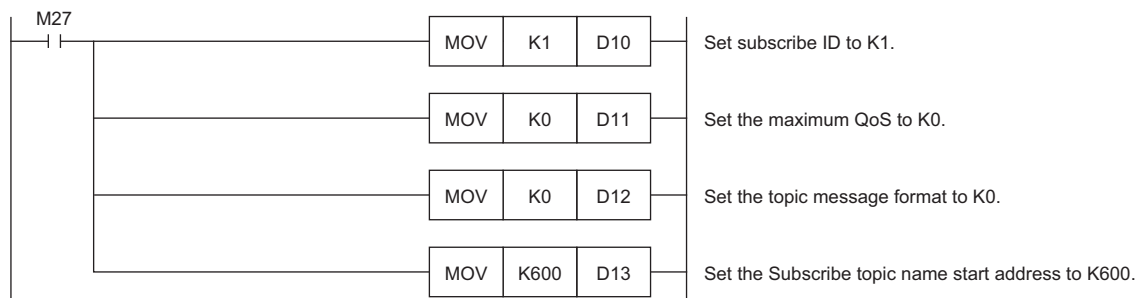

M29 (Execution command) turns on. After M23 (Execution status) turns on, M21 (SUBSCRIBE instruction) turns on for sending the SUBSCRIBE command.

After the Subscribe is successfully sent, M26 (Send completion) turns on.

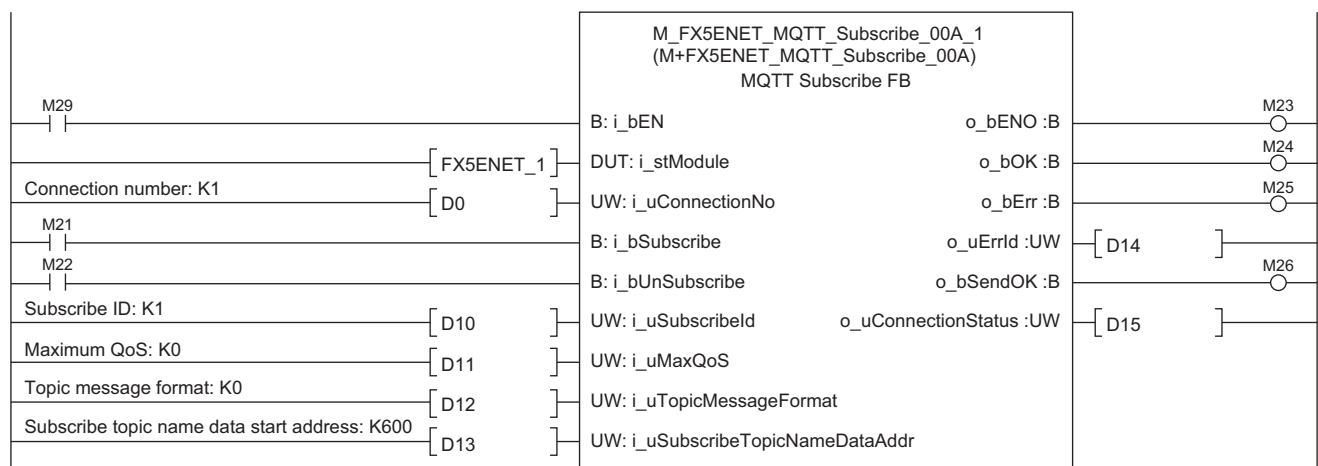

5.3 Checking the Operation of Publish (Sending of MQTT Data)

Create a JSON string with M+StrProcessing_JSONSerialize_F, and use M+FX5ENET_MQTT_PublishSend (Sending of MQTT data) to send messages to the server (MQTT broker).

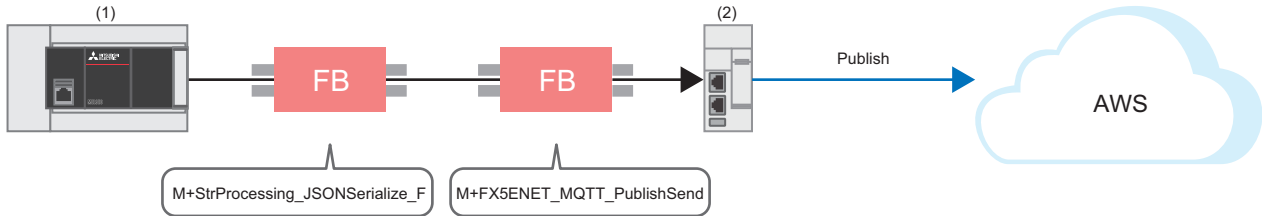

- (1) FX5U CPU module
- (2) FX5-ENET

FB library registration

Register the FB library. For the operating procedures, refer to the following.

☞ Page 53 FB Library

Program

■ Send data creation

- Settings for data to be sent

M50 (Execution command) turns on for setting the data to be sent.

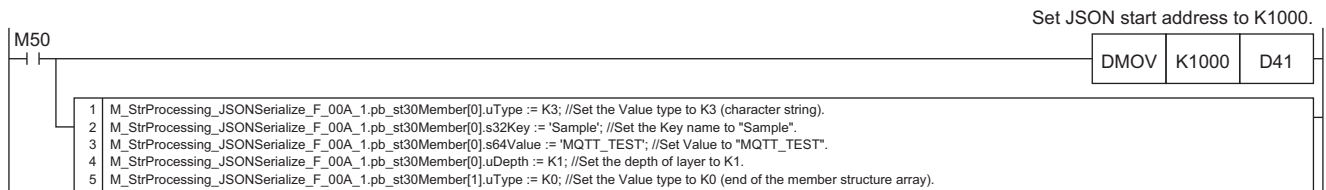

- JSON string creation

When M50 (Execution command) turns on, the function block creates a JSON string in accordance with the information of uType (Value type), s32Key (Key name), s64Value (value of Value), and uDepth (depth of layer) in the set member list (pb_st30Member) and it outputs the string to the file register at the address specified with the start address of the JSON string storage destination.

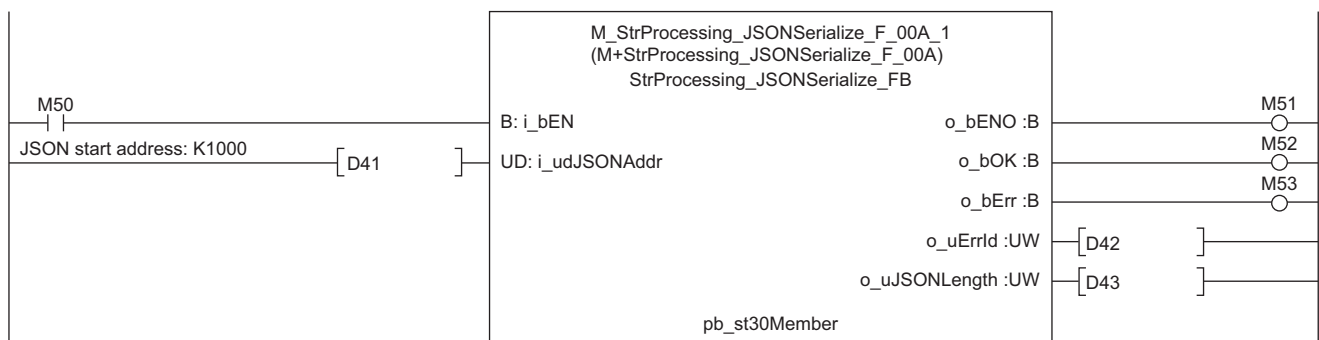

■ Sending of message data

M67 turns on for setting the information used for M+ENET_MQTT_PublishSend (Sending of MQTT data).

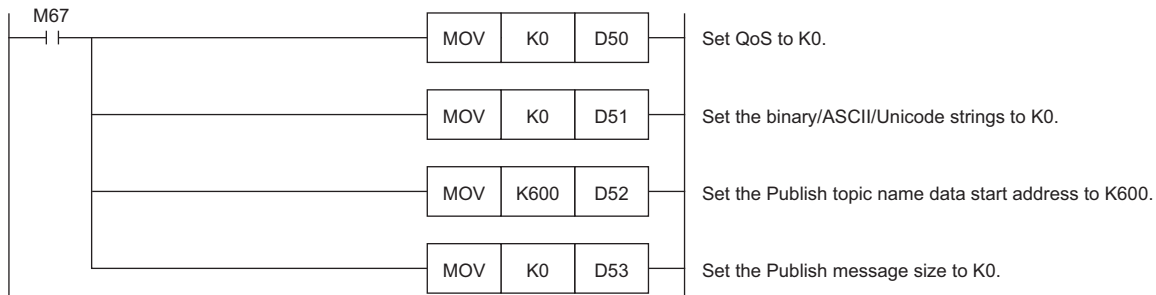

M69 (Execution command) turns on. After M63 (Execution status) turns on, M61 (PUBLISH instruction (Rise detection)) turns on for sending a message.

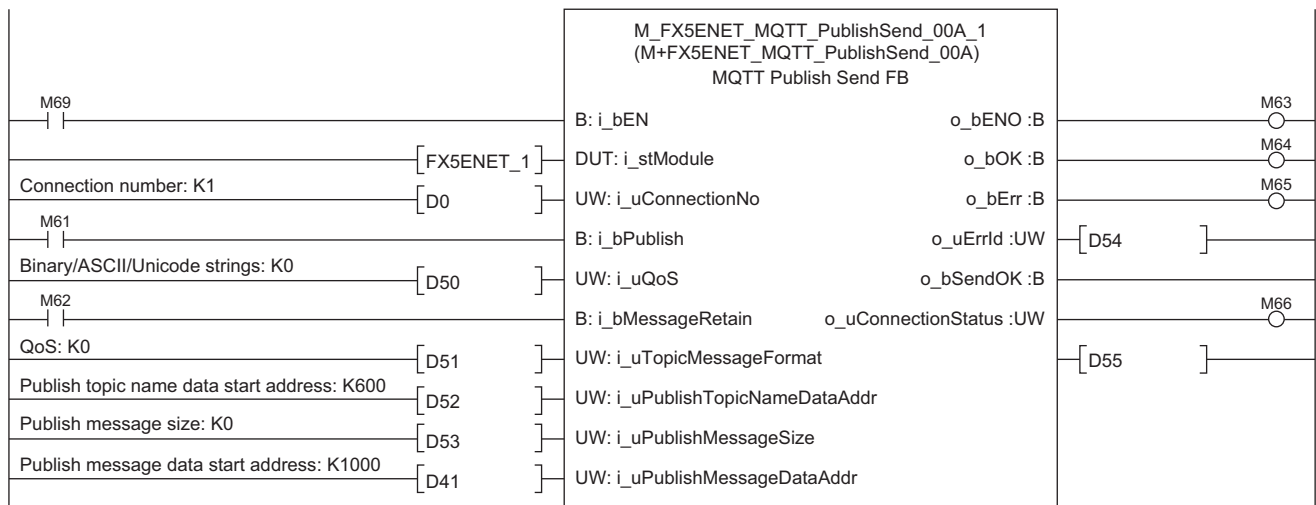

Checking reception on AWS

The sent message can be checked from [Test] ⇒ [MQTT test client] in the left menu of AWS.

Enter "MQTT_TEST/topic/name" in [Topic filter]. ⇒ Click the [Subscribe] button.

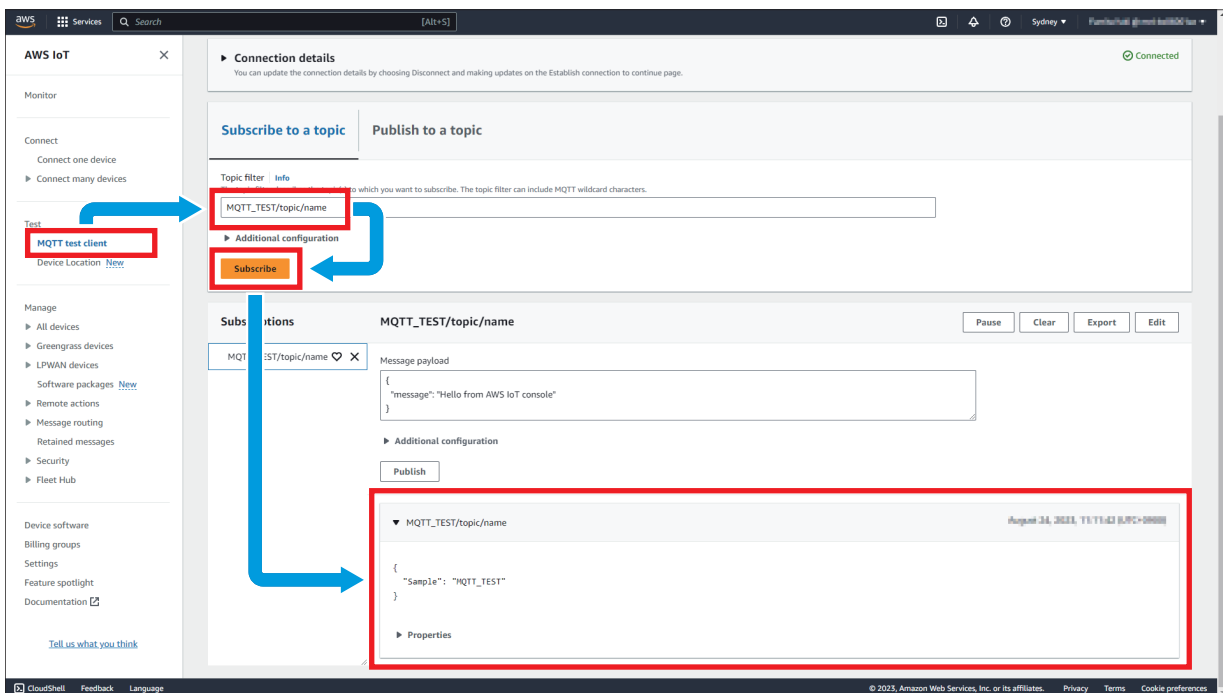

5.4 Checking the Operation of Subscribe (Receiving of MQTT Data)

Use M+FX5ENET_MQTT_Receive (Receiving of MQTT data) for reading a message received from the server (MQTT broker).

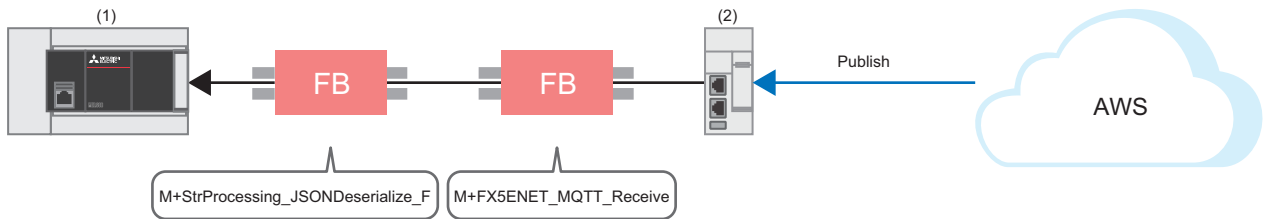

- (1) FX5U CPU module
- (2) FX5-ENET

FB library registration

Register the FB library. For the operating procedures, refer to the following.

 Page 53 FB Library

Program

■Receiving of message data

M34 turns on for setting the information used for M+ENET_MQTT_Receive (Receiving of MQTT data).

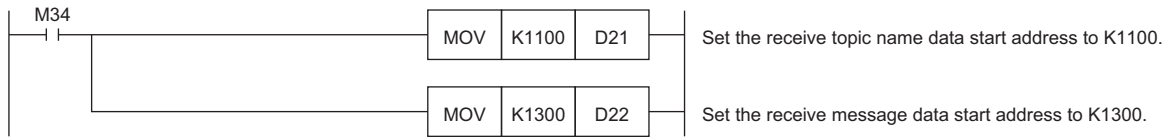

M36 (Execution command) turns on for storing the receive data into the specified file register.

After the data is successfully received, M32 (Normal completion) turns on. The receive data is stored in the file register set with `i_uReceiveTopicNameDataAddr` (Receive topic name data start address) and `i_uReceiveMessageDataAddr` (Receive message data start address).

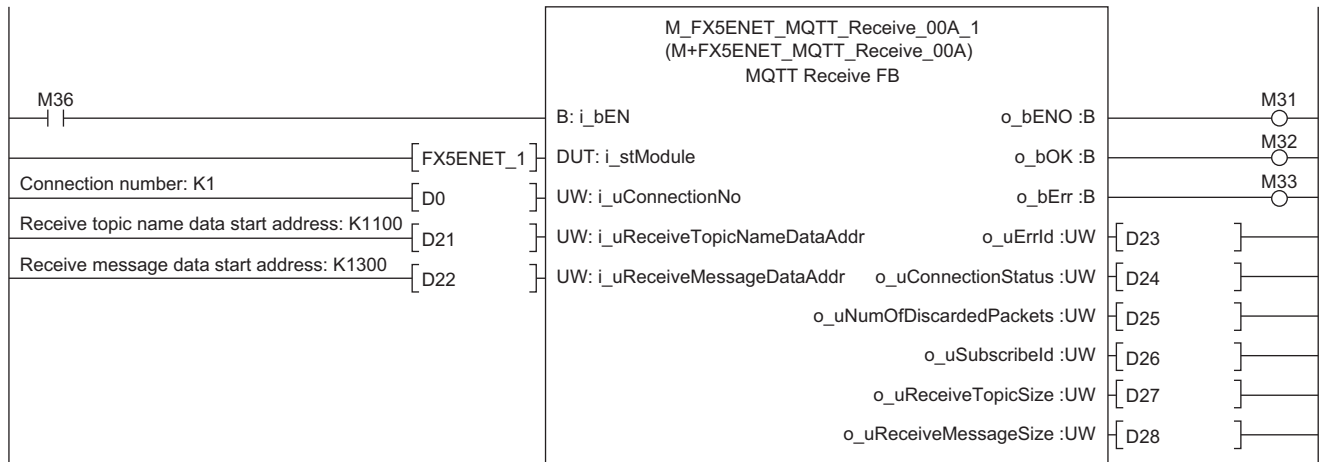

■Acquisition of only the required strings from receive data

- Settings for required member information

M40 (Execution command) turns on for setting the member information to be acquired.

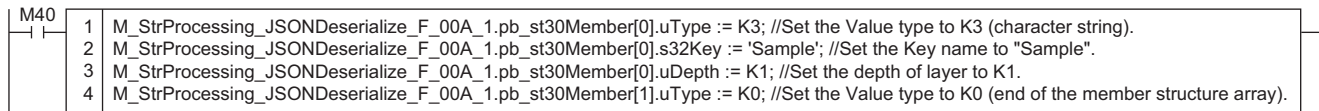

- Acquisition of JSON string

When M40 (Execution command) turns on, the function block acquires the Value strings that exactly match the values of `uType` (Value type), `s32Key` (Key name), and `uDepth` (depth of layer) in the set member list (`pb_st30Member`) from JSON strings stored at the JSON start address, and it stores the values into the `s64Value` (Value) values in the member list (`pb_st30Member`).

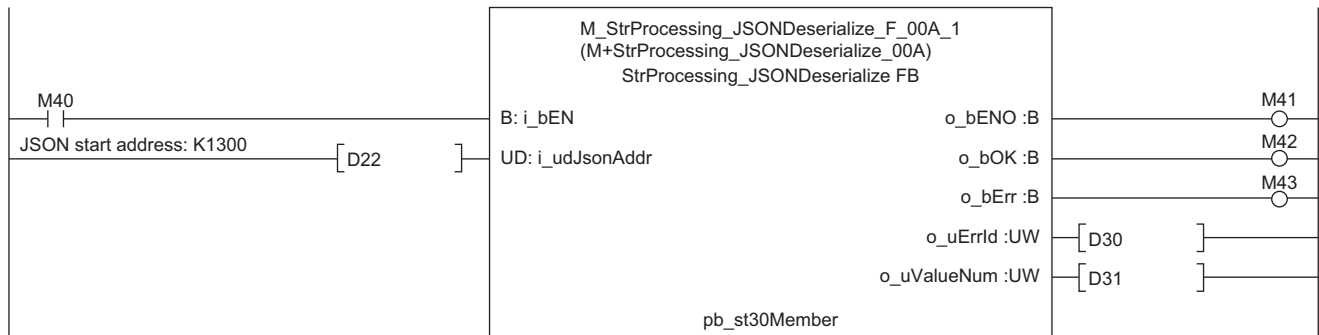

Checking reception on GX Works3

Messages received from AWS can be checked from the "Device/Buffer Memory Batch Monitor" of GX Works3.

 [Online] ⇒ [Monitor] ⇒ [Device/Buffer Memory Batch Monitor]

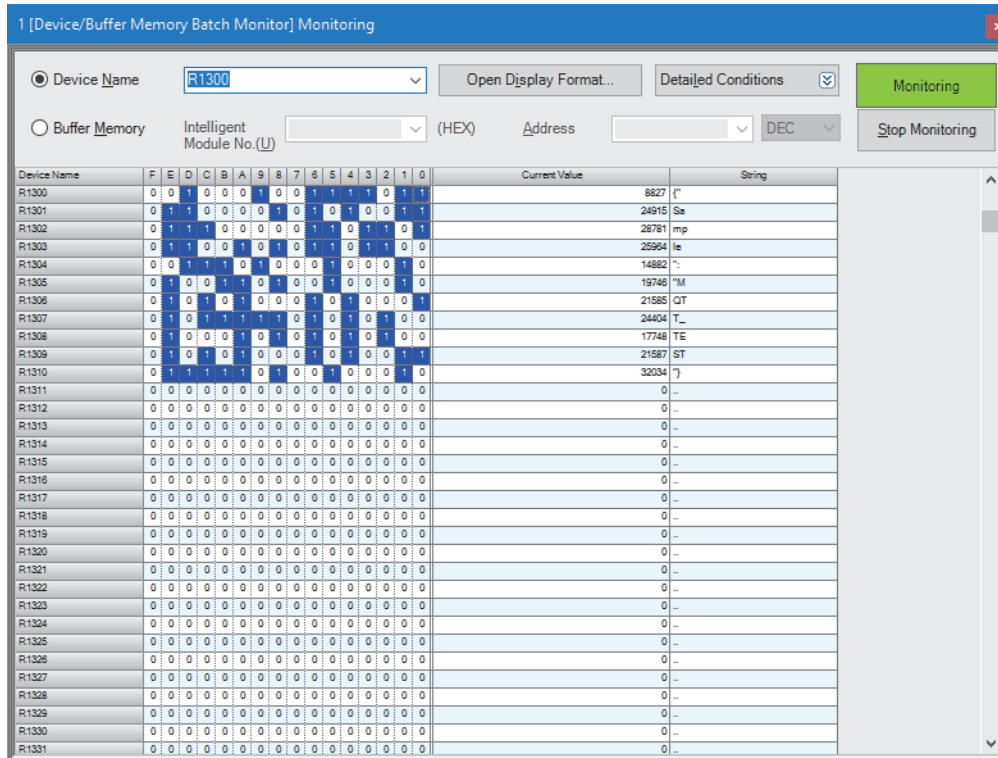

Device Name	F	E	D	C	B	A	9	8	7	6	5	4	3	2	1	0	Current Value	String
R1300	0	0	1	0	0	0	1	0	0	0	1	1	1	0	1	1	8827	f
R1301	0	1	1	0	0	0	0	1	0	0	1	0	0	0	1	1	24915	Sa
R1302	0	1	1	1	0	0	0	0	0	0	1	0	1	1	0	1	28781	mp
R1303	0	1	1	0	0	1	0	1	0	1	0	1	0	1	1	0	25964	le
R1304	0	0	1	1	0	1	0	1	0	0	0	1	0	0	0	1	14882	~
R1305	0	1	0	0	1	1	0	1	0	0	1	0	0	0	1	0	19746	M
R1306	0	1	0	1	0	1	0	0	0	0	1	0	0	0	1	1	21585	QT
R1307	0	1	0	1	1	1	1	1	0	1	0	1	0	1	0	0	24404	T_
R1308	0	1	0	0	1	0	1	0	0	0	1	0	1	0	0	0	17748	TE
R1309	0	1	0	1	0	1	0	0	0	0	0	1	0	0	1	1	21587	ST
R1310	0	1	1	1	1	0	1	0	1	0	0	0	0	0	1	0	32034	J
R1311	0	0	0	0	0	0	0	0	0	0	0	0	0	0	0	0	0	-
R1312	0	0	0	0	0	0	0	0	0	0	0	0	0	0	0	0	0	-
R1313	0	0	0	0	0	0	0	0	0	0	0	0	0	0	0	0	0	-
R1314	0	0	0	0	0	0	0	0	0	0	0	0	0	0	0	0	0	-
R1315	0	0	0	0	0	0	0	0	0	0	0	0	0	0	0	0	0	-
R1316	0	0	0	0	0	0	0	0	0	0	0	0	0	0	0	0	0	-
R1317	0	0	0	0	0	0	0	0	0	0	0	0	0	0	0	0	0	-
R1318	0	0	0	0	0	0	0	0	0	0	0	0	0	0	0	0	0	-
R1319	0	0	0	0	0	0	0	0	0	0	0	0	0	0	0	0	0	-
R1320	0	0	0	0	0	0	0	0	0	0	0	0	0	0	0	0	0	-
R1321	0	0	0	0	0	0	0	0	0	0	0	0	0	0	0	0	0	-
R1322	0	0	0	0	0	0	0	0	0	0	0	0	0	0	0	0	0	-
R1323	0	0	0	0	0	0	0	0	0	0	0	0	0	0	0	0	0	-
R1324	0	0	0	0	0	0	0	0	0	0	0	0	0	0	0	0	0	-
R1325	0	0	0	0	0	0	0	0	0	0	0	0	0	0	0	0	0	-
R1326	0	0	0	0	0	0	0	0	0	0	0	0	0	0	0	0	0	-
R1327	0	0	0	0	0	0	0	0	0	0	0	0	0	0	0	0	0	-
R1328	0	0	0	0	0	0	0	0	0	0	0	0	0	0	0	0	0	-
R1329	0	0	0	0	0	0	0	0	0	0	0	0	0	0	0	0	0	-
R1330	0	0	0	0	0	0	0	0	0	0	0	0	0	0	0	0	0	-
R1331	0	0	0	0	0	0	0	0	0	0	0	0	0	0	0	0	0	-

6 TROUBLESHOOTING

6.1 Checking Procedure

1. Checking the LED status

Check the communication status with the display status of the LEDs.

For the FX5U CPU module, refer to the following.

📖 MELSEC iQ-F FX5S/FX5UJ/FX5U/FX5UC User's Manual (Hardware), Section 17.2 Checking with LEDs

For the FX5-ENET, refer to the following.

📖 MELSEC iQ-F FX5 Ethernet Module User's Manual, Section 10.1 Checking with LEDs

For the router, refer to the manual of the router used.

2. Checking the error code

Check the following according to the error code of the error occurred in the FX5U CPU module and FX5-ENET.

For the FX5U CPU module, refer to the following.

- Error codes common to CPU modules

📖 MELSEC iQ-F FX5 User's Manual (Application), Appendix 3 Error Code

- Error codes related to Ethernet communication of CPU modules

📖 MELSEC iQ-F FX5 User's Manual (Communication), Section 47.1 Ethernet Communication

For the FX5-ENET, refer to the following.

📖 MELSEC iQ-F FX5 Ethernet Module User's Manual, Section 10.6 List of Error Codes

■Checking the wiring

For the wiring, refer to the following.

📖 Page 9 System Configuration

- Are the Ethernet cables fully inserted?

■Checking the communication settings

Refer to 📖 Page 12 CONFIGURING CLIENTS (MQTT PUBLISHER, MQTT SUBSCRIBER) and 📖 Page 25 CONFIGURING SERVER (MQTT BROKER) CONNECTION.

- Are the GX Works3 parameter settings, Certificate Configuration Tool for FX5-ENET settings, and AWS setting details correct?
- Are the IP address and subnet mask settings of the FX5U CPU module, FX5-ENET, personal computer, and router correct?
- If a firewall is set up between the FX5-ENET and the personal computer, has permission been given to the port to be used?

3. Checking the AWS settings

For the AWS settings, follow the instructions on the window or contact the support center.

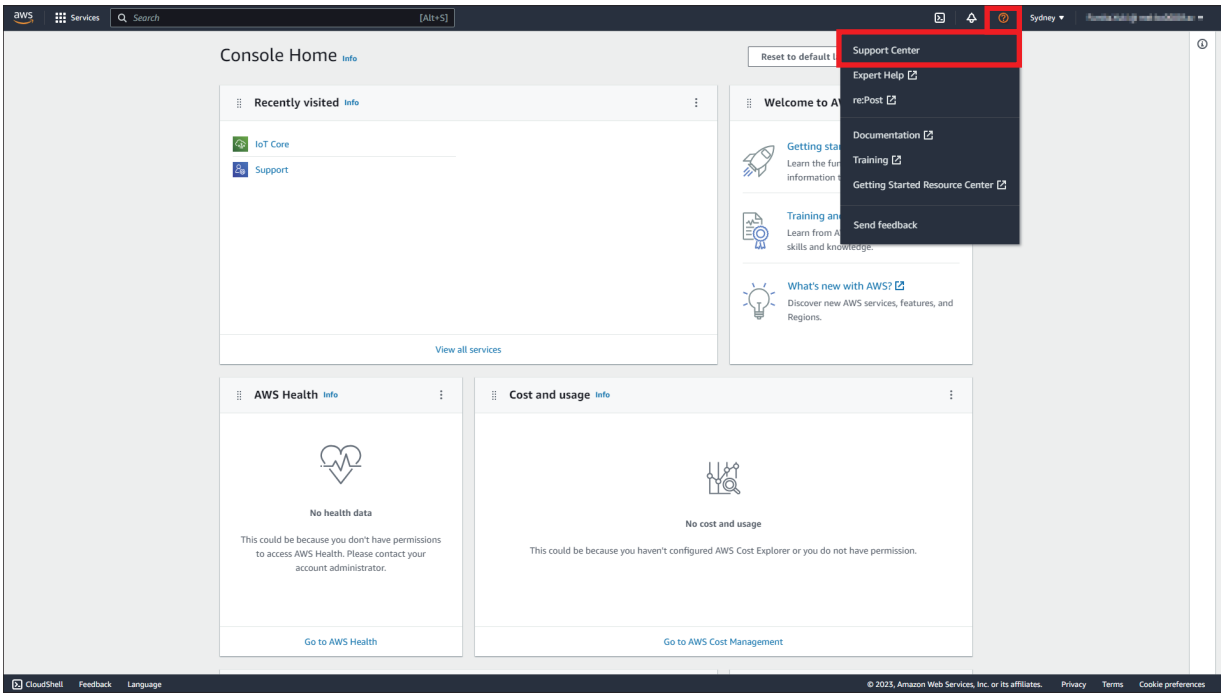

APPENDICES

Appendix 1 List of FX5 Ethernet-equipped Module FBs

The FX5 Ethernet-equipped module FB library contains the following FBs. Programs are created by combining FBs according to each application.

Name	Description
M+FX5ENET_MQTT_Connect	Controls the connection with a server (MQTT broker) to establish a TCP or TLS session by the CONNECT instruction or to disconnect the session by the DISCONNECT instruction.
M+FX5ENET_MQTT_PublishSend	Sends a message to the server (MQTT broker).
M+FX5ENET_MQTT_Receive	Reads a message received from the server (MQTT broker).
M+FX5ENET_MQTT_Subscribe	Sends a SUBSCRIBE/UNSUBSCRIBE command to the server (MQTT broker).

Appendix 2 FB Library

Downloading the FB library

In this manual, the character string operation FB library is used.

To obtain the FB library, please contact your local Mitsubishi Electric representative.

Importing the FB library

This section describes how to register the obtained FB library to GX Works3. Decompress the FB library folder (zip file) before registering the FB library.

1. Start GX Works3, and select [Project] on the toolbar ⇒ [New].

In this manual, the following settings are used.

Item	Description
Series	FX5CPU
Type	FX5U
Program Language	Ladder

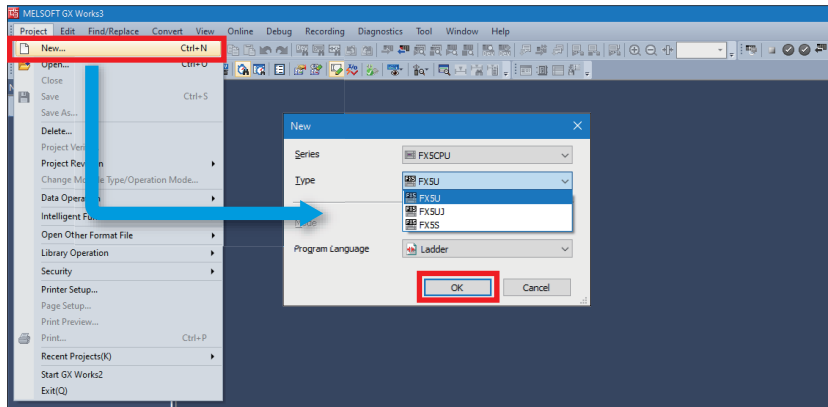

2. Select [Project] on the toolbar ⇒ [Library Operation] ⇒ [Register to Library List] ⇒ [Library].

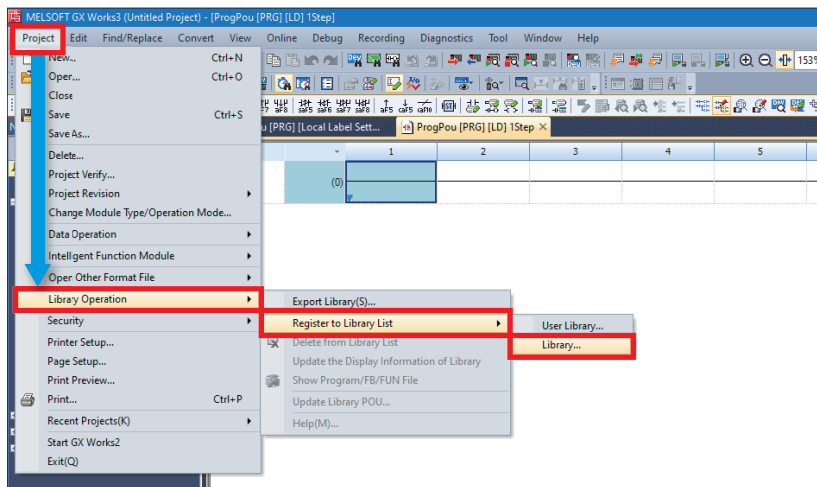

3. Select the "StrProcessing_F.mslm" file in the decompressed FB library folder, and click [Open].

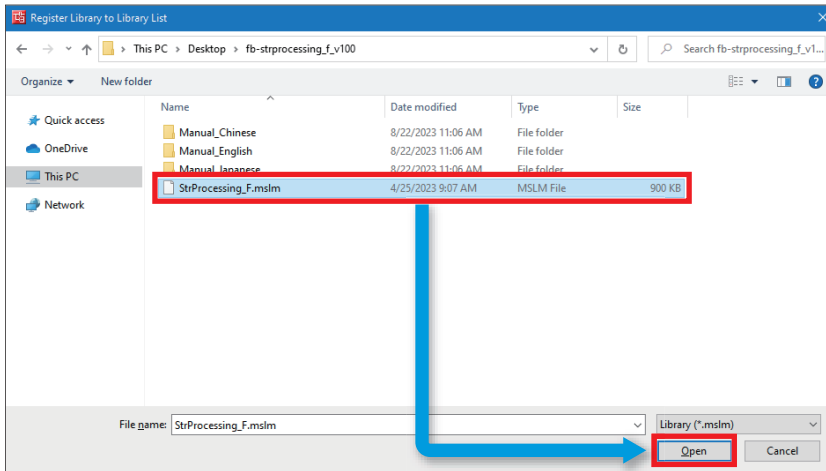

4. The selected file is added to [Library] in the "Element Selection" window.

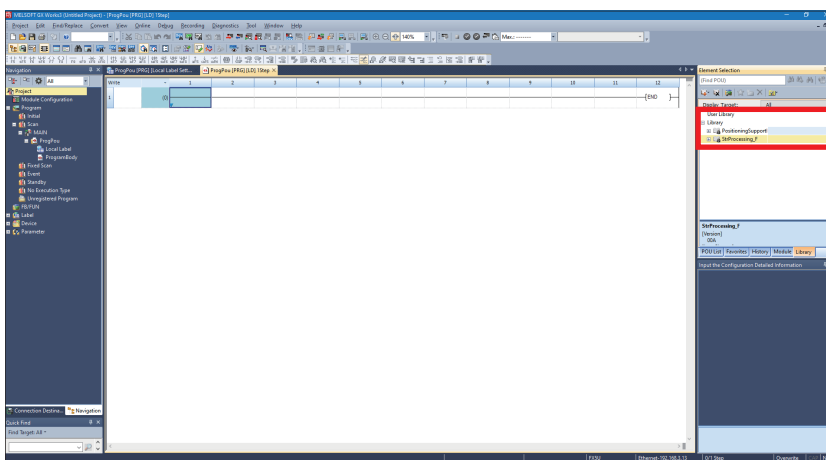

If the "Element Selection" window is not displayed, select [View] on the toolbar ⇒ [Docking Window] ⇒ [Element Selection] to open the window.

How to use the FB library

Select an FB registered in the library from the "Element Selection" window, and drag and drop it to the program editor. Create an input ladder and an output ladder of the pasted FB to create a program.

Arrange the FB input ladder to the left side, and output ladder to the right side of the window in the same manner as standard ladder programs.

1. Go to the "Element Selection" window ⇒ the [Library] tab ⇒ [Library]. Then, select an FB to be used and drop it in the program editor. When the "FB Instance Name" window appears, click the [OK] button.

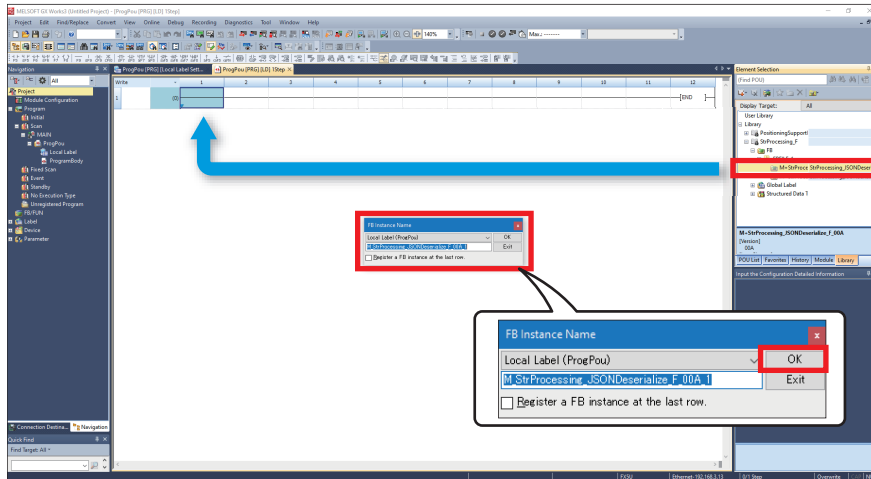

2. The FB is pasted to the program editor.

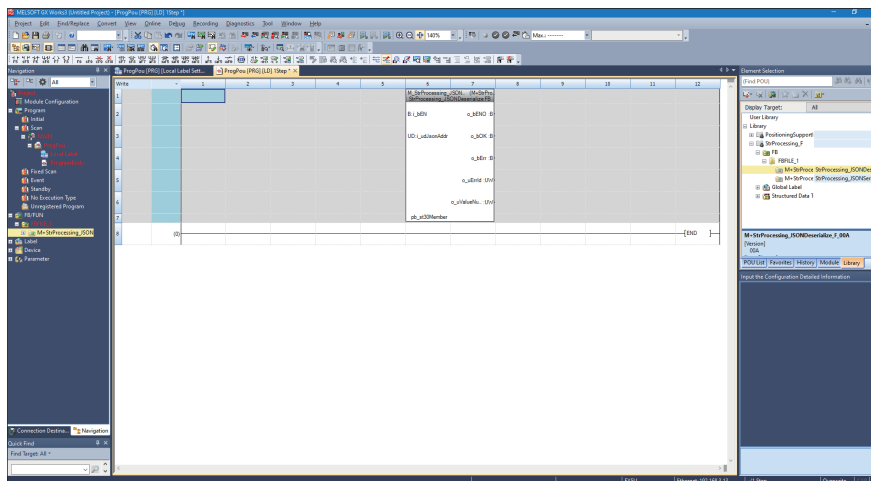

3. Insert a contact and input to B:i_BEN.

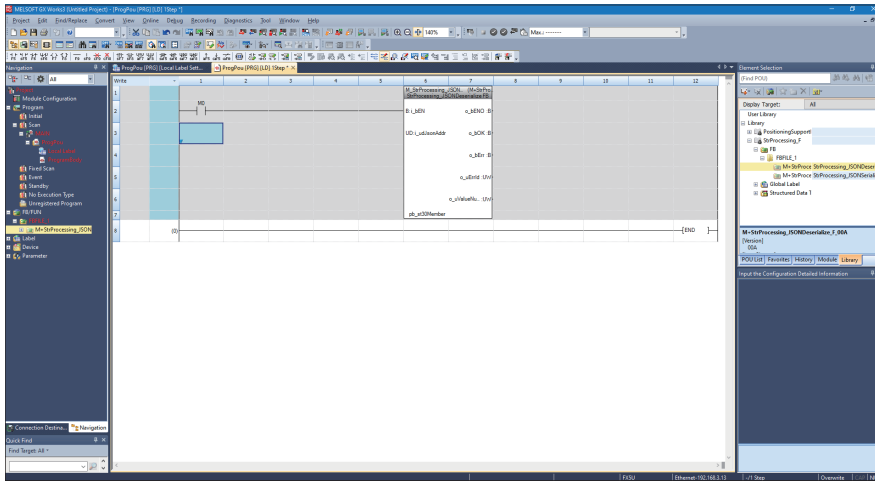

4. Insert an FB word device input to the left side of the FB. Insert an FB word device output to the right side of the FB.

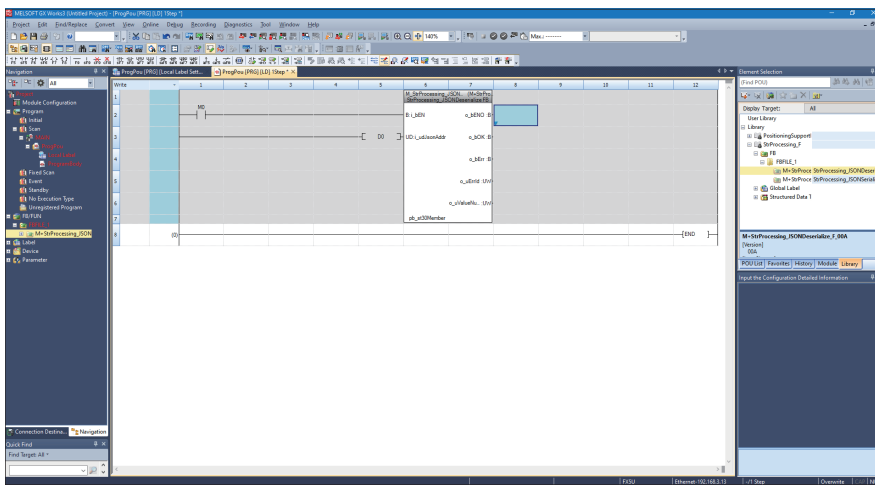

5. Repeat these steps to create the ladder.

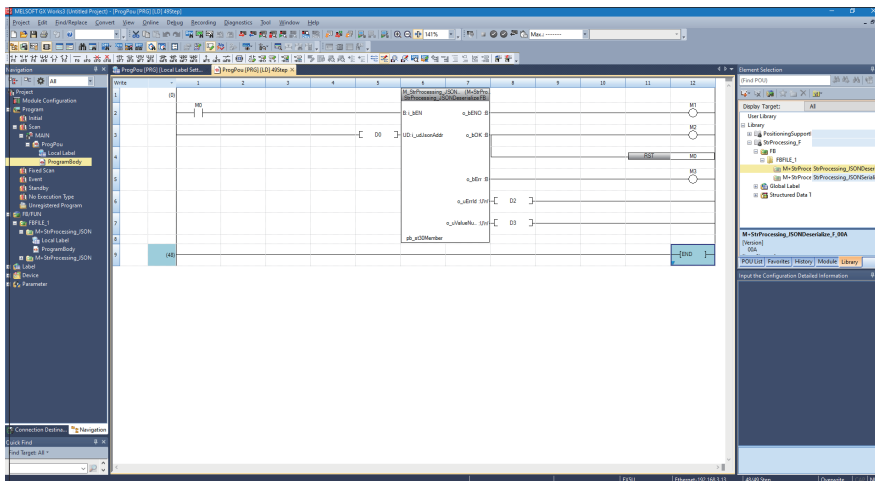

Appendix 3 How to Use the Program Copy Function of e-Manual

Program examples in e-Manual can be copied and pasted to GX Works3.

1. Click "Copy Ladder Program (for GX Works3)" in e-Manual.

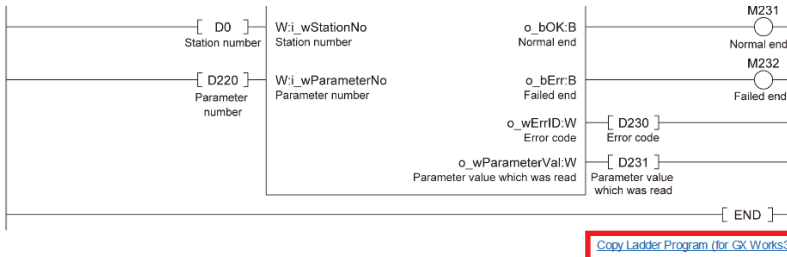

2. Right-click the mouse on the ladder editor of GX Works3, and select [Paste].

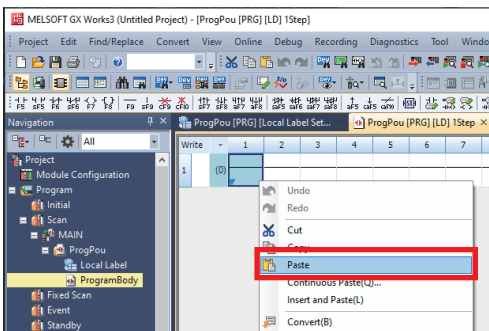

3. The copied program is pasted in undefined state. Select the FB used in the program example from [Library] on the "Element Selection" window, and drag and drop it to the FB area on the ladder editor.

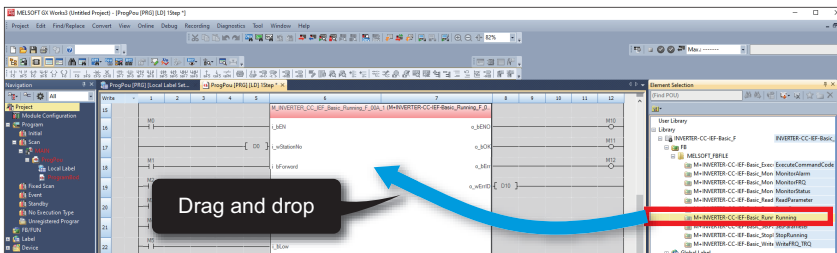

Point

When an FB is used in the program example, the definition of the FB will be unclear immediately after the program is pasted to the ladder editor. Drag and drop the FB from the "Element Selection" window to define the FB properly.

Unclear definition of FB	
M_INVERTER_CC_IFF_Basic_Running_F_00A_1 (M-INVERTER-CC-IEF-Basic_Running_F_	
L_BEN	o_bENO
L_wStationNo	o_bOKB
L_bForward	o_bErrB
L_bReverse	o_wErrIDW
L_bHigh	
L_bMiddle	
L_bLow	

Properly defined FB	
M_INVERTER_CC_IFF_Basic_Running_F_00A_1 (M-INVERTER-CC-IEF-Basic_Running_F_	
B_L_BEN	o_bENO B
W_L_wStationNo	o_bOKB
B_L_bForward	o_bErrB
B_L_bReverse	o_wErrIDW
B_L_bHigh	
B_L_bMiddle	
B_L_bLow	

4. Click the [OK] button on the "FB Instance Name" window.



5. When the FB is properly defined, the FB instance name is highlighted in gray.

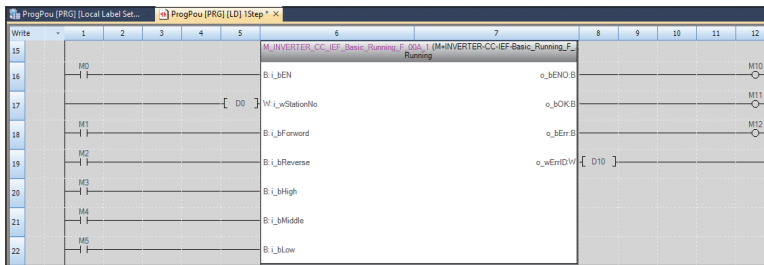

Point

Label items (label name, data type, and others) are copied in the order defined as an example in this manual. Therefore, define label items in the same order as shown on the label editor of the engineering tool.

■ **Labels to be defined**
Define global labels as follows.

	Label Name	Data Type	Class	Assign (Device/Label)
1	bStartDirection_1	Bit	VAR_GLOBAL	M200
2	bStartDirection_2	Bit	VAR_GLOBAL	M201

[Copy labels \(for GX Works3\)](#)

Simple display

Switch simple display and detailed display using the [Easy Display] and [Show Details] buttons.

■ Same label item order

■ Different label item order

If the label items copied are different order from the order used at the pasting destination, incorrect items are pasted or some items will not be defined.

MEMO

A

REVISIONS

Revision date	Version	Description
October 2023	A	First edition
December 2023	B	■Modified parts RELEVANT MANUALS, Section 2.3, 4.3, 5.3, 5.4, 6.1

Japanese manual number: L08896-B

This manual confers no industrial property rights or any rights of any other kind, nor does it confer any patent licenses. Mitsubishi Electric Corporation cannot be held responsible for any problems involving industrial property rights which may occur as a result of using the contents noted in this manual.

© 2023 MITSUBISHI ELECTRIC CORPORATION

WARRANTY

Please confirm the following product warranty details before using this product.

📖 MELSEC iQ-F FX5S/FX5UJ/FX5U/FX5UC User's Manual (Hardware), WARRANTY

📖 MELSEC iQ-F FX5 Ethernet Module User's Manual, WARRANTY

TRADEMARKS

Microsoft Edge and Windows are trademarks of the Microsoft group of companies.

Amazon Web Services and AWS are trademarks of Amazon.com, Inc. or its affiliates.

The company names, system names and product names mentioned in this manual are either registered trademarks or trademarks of their respective companies.

In some cases, trademark symbols such as [™] or [®] are not specified in this manual.

Country/Region, Sales office, Tel/Fax

<p>USA mitsubishi electric automation, inc. 500 Corporate Woods Parkway, Vernon Hills, IL 60061, U.S.A. Tel :+1-847-478-2100 Fax:+1-847-478-2253</p>	<p>Mexico mitsubishi electric automation, inc. Mexico Branch Boulevard Miguel de Cervantes Saavedra 301, Torre Norte Piso 5, Int. 502, Ampliacion Granada, Miguel Hidalgo, Ciudad de Mexico, Mexico, C.P.11520 Tel :+52-55-3067-7500</p>	<p>Brazil mitsubishi electric do brasil comercio e servicos ltda. Avenida Adelino Cardana, 293, 21 andar, Bethaville, Barueri SP, Brasil Tel :+55-11-4689-3000 Fax:+55-11-4689-3016</p>
<p>Germany mitsubishi electric europe b.v. German Branch Mitsubishi-Electric-Platz 1, 40882 Ratingen, Germany Tel :+49-2102-486-0 Fax:+49-2102-486-7780</p>	<p>UK mitsubishi electric europe b.v. UK Branch Travellers Lane, UK-Hatfield, Hertfordshire, AL10 8XB, U.K. Tel :+44-1707-28-8780 Fax:+44-1707-27-8695</p>	<p>Ireland mitsubishi electric europe b.v. Irish Branch Westgate Business Park, Ballymount, Dublin 24, Ireland Tel :+353-1-4198800 Fax:+353-1-4198890</p>
<p>Italy mitsubishi electric europe b.v. Italian Branch Campus, Energy Park Via Energy Park 14, Vimercate 20871 (MB) Italy Tel :+39-039-60531 Fax:+39-039-6053-312</p>	<p>Spain mitsubishi electric europe, b.v. Spanish Branch Carretera de Rubi, 76-80-Apdo. 420, E-08190 Sant Cugat del Valles (Barcelona), Spain Tel :+34-935-65-3131 Fax:+34-935-89-1579</p>	<p>France mitsubishi electric europe b.v. French Branch 25, Boulevard des Bouvets, 92741 Nanterre Cedex, France Tel :+33-1-55-68-55-68 Fax:+33-1-55-68-57-57</p>
<p>Czech Republic mitsubishi electric europe b.v. Czech Branch Pekarska 621/7, 155 00 Praha 5, Czech Republic Tel :+420-734-402-587</p>	<p>Poland mitsubishi electric europe b.v. Polish Branch ul. Krakowska 48, 32-083 Balice, Poland Tel :+48-12-347-65-00</p>	<p>Sweden mitsubishi electric europe b.v. (Scandinavia) Hedvig Mollersgata 6, 223 55 Lund, Sweden Tel :+46-8-625-10-00 Fax:+46-46-39-70-18</p>
<p>Turkey mitsubishi electric turkey elektrik urunleri a.s. Serifali Mahallesi Kale Sokak No:41 Umraniye / Istanbul Tel :+90-216-969-2500 Fax:+90-216-661-4447</p>	<p>UAE mitsubishi electric europe b.v. Dubai Branch Dubai Silicon Oasis, P.O.BOX 341241, Dubai, U.A.E. Tel :+971-4-3724716 Fax:+971-4-3724721</p>	<p>South Africa ADROIT TECHNOLOGIES 20 Waterford Office Park, 189 Witkoppen Road, Fourways, South Africa Tel :+27-11-658-8100 Fax:+27-11-658-8101</p>
<p>China mitsubishi electric automation (china) ltd. Mitsubishi Electric Automation Center, No.1386 Hongqiao Road, Shanghai, China Tel :+86-21-2322-3030 Fax:+86-21-2322-3000</p>	<p>Taiwan SETSUYO ENTERPRISE CO., LTD. 6F, No.105, Wugong 3rd Road, Wugu District, New Taipei City 24889, Taiwan Tel :+886-2-2299-2499 Fax:+886-2-2299-2509</p>	<p>Korea mitsubishi electric automation korea co., ltd. 7F to 9F, Gangseo Hangang Xi-tower A, 401, Yangcheon-ro, Gangseo-Gu, Seoul 07528, Korea Tel :+82-2-3660-9569 Fax:+82-2-3664-8372</p>
<p>Singapore mitsubishi electric asia pte. ltd. 307 Alexandra Road, Mitsubishi Electric Building, Singapore 159943 Tel :+65-6473-2308 Fax:+65-6476-7439</p>	<p>Thailand mitsubishi electric factory automation (thailand) co., ltd. 101, True Digital Park Office, 5th Floor, Sukhumvit Road, Bang Chak, Prakanong, Bangkok, Thailand Tel :+66-2682-6522-31 Fax:+66-2682-6020</p>	<p>Vietnam mitsubishi electric vietnam company limited 11th & 12th Floor, Viettel Tower B, 285 Cach Mang Thang 8 Street, Ward 12, District 10, Ho Chi Minh City, Vietnam. Tel :+84-28-3910-5945 Fax:+84-28-3910-5947</p>
<p>Indonesia PT. MITSUBISHI ELECTRIC INDONESIA Gedung Jaya 8th Floor, JL. MH. Thamrin No.12, Jakarta Pusat 10340, Indonesia Tel :+62-21-31926461 Fax:+62-21-31923942</p>	<p>India mitsubishi electric india pvt. ltd. Pune Branch Emerald House, EL-3, J Block, M.I.D.C., Bhosari, Pune-411026, Maharashtra, India Tel :+91-20-2710-2000 Fax:+91-20-2710-2100</p>	<p>Australia mitsubishi electric australia Pty. Ltd. 348 Victoria Road, P.O. Box 11, Rydalmere, N.S.W 2116, Australia Tel :+61-2-9684-7777 Fax:+61-2-9684-7245</p>



Mitsubishi Electric's e-F@ctory concept utilizes both FA and IT technologies, to reduce the total cost of development, production and maintenance, with the aim of achieving manufacturing that is a "step ahead of the times". It is supported by the e-F@ctory Alliance Partners covering software, devices, and system integration, creating the optimal e-F@ctory architecture to meet the end users needs and investment plans.



MITSUBISHI ELECTRIC CORPORATION
 HEAD OFFICE: TOKYO BLDG., 2-7-3, MARUNOUCHI, CHIYODA-KU, TOKYO 100-8310, JAPAN