

# MITSUBISHI

## 三菱電機 **ビル空調** フリープランシステム 2004年度版

直膨式マルチエアコンシステム新冷媒シリーズ

## システム設計・工事マニュアル

### 製品編

# R410A対応

### シティマルチ **YECO** シリーズ

PUHY-P140 P160 P224 P280 P335 P355 P400 P450 P500 P560 P630 P674 P730M-E

PUHY-P784 P840 P900SM-E

PUHY-P960 P1010 P1080,P1130,P1180,P1240,P1300,P1360,P1400SKM-E



2004 三菱電機 **ビル空調** フリープランシステム 直膨式マルチエアコンシステム新冷媒シリーズシステム設計・工事マニュアル

三菱電機株式会社

三菱電機 **ビル空調** フリープランシステム 2004年度版

直膨式マルチエアコンシステム新冷媒シリーズ

システム設計・工事マニュアル

**三菱電機株式会社** 〒640-8686 和歌山市手平6-5-66 冷熱システム製作所 (073)436-9807  
お問い合わせは下記へどうぞ

三菱電機住環境システムズ株式会社	北海道社	(011) 893 - 1342
三菱電機住環境システムズ株式会社	東北社	(022) 231 - 2785
三菱電機住環境システムズ株式会社	東京社	(03) 3847 - 4338
三菱電機住環境システムズ株式会社	中部社	(052) 725 - 2045
	北陸営業本部	(076) 252 - 9935
三菱電機住環境システムズ株式会社	関西社	(06) 6310 - 5060
三菱電機住環境システムズ株式会社	中四国社	(082) 278 - 7001
	四国営業本部	(087) 879 - 1066
三菱電機住環境システムズ株式会社	九州社	(092) 571 - 7014
(株)三菱電機ライフネットワーク	電住空調部	(03) 3570 - 6822
沖縄三菱電機販売(株)		(098) 898 - 1111



### 三菱電機空調ワンコールシステム

0120-9-24365 (フリーコール)

「修理依頼」「サービス部品注文」(365日・24時間受付)  
「技術相談」(月～土曜 9:00～19:00、日曜・祝日 9:00～17:00)

### 設計サポートStation

三菱電機 冷熱・換気・照明設備機器の情報サービス

かんたんアクセス **Yahoo!**で 空調図面 **クリック!** 設計サポートStationを選択  
www.MitsubishiElectric.co.jp/sss/

### 三菱電機冷熱相談センター

0037-80-2224 (フリーボイス) / 073-427-2224 (携帯電話対応)  
(月～土曜 9:00～19:00、日曜・祝日 9:00～17:00)

FAX (365日・24時間受付) 0037-80-2229 (フリーボイス) / 073-428-2229 (通常FAX)

業界初 役に立つサービス情報を発信するITツール  
携帯電話から空調機の簡易点検内容が検索できます。

<http://www.MitsubishiElectric.co.jp/sss/ptc/>

検索対象 **スリムエアコン** **ビル用マルチエアコン** **冷凍機**

# 安全のために必ず守ること

- この「安全のために必ず守ること」をよくお読みのうえ据付けてください。
- ここに示した注意事項は、安全に関する重大な内容を記載していますので、必ず守ってください。

<b>⚠警告</b>	誤った取扱いをしたときに、死亡や重傷等の重大な結果に結び付く可能性が大きいもの。
<b>⚠警告</b>	誤った取扱いをしたときに、状況によっては重大な結果に結び付く可能性があるもの。

- お読みになったあとは、お使いになる方に必ず本書をお渡しください。
- お使いになる方は、いつでも見られる所に大切に保管し、移設・修理の時は、工事をされる方にお渡しください。また、お使いになる方が代わる場合は、新しくお使いになる方にお渡しください。

## ⚠警告

据付けは、販売店または専門業者に依頼してください。

- ご自分で据付工事をされ不備があると、水漏れや感電、火災等の原因になります。

据付けは、質量に十分耐える所に確実に行ってください。

- 強度が不足している場合は、ユニット落下により、けがの原因になります。

配線は、所定のケーブルを使用して確実に接続し、端子接続部にケーブルの外力が伝わらないように確実に固定してください。

- 接続や固定が不完全な場合は、発熱、火災等の原因になります。

台風等の強風、地震に備え、所定の据付工事を行ってください。

- 据付工事に不備があると、転倒等による事故の原因になります。

空気清浄機、加湿器、暖房用電気ヒーター等の別売品は必ず、当社指定の製品を使用してください。

- また、取付けは専門の業者に依頼してください。ご自分で取付けをされ、不備があると、水漏れや感電、火災等の原因になります。

改修は絶対にしないでください。また、修理は、お買上げの販売店にご相談ください。

- 修理に不備があると水漏れや感電、火災等の原因になります。

熱交換器のフィン表面を素手で触れないように注意してください。

- 取扱いに不備があると、切傷の原因になります。

作業中に冷媒ガスが漏れた場合は、換気してください。

- 冷媒ガスが火気に触れると、有毒ガスが発生する原因になります。

オールフレッシュタイプはサーモOFF等により外気が直接室内に吹出すことがありますので、施工には十分ご注意ください。

- 外気が人体や食品に直接あたると、外気温度によっては健康障害や食品劣化等の原因になります。

据付工事は、この据付説明書に従って確実に行ってください。

- 据付けに不備があると、水漏れや感電、火災等の原因になります。

電気工事は、電気工事士の資格のある方が、「電気設備に関する技術基準」、「内線規程」および据付説明書に従って施工し、必ず専用回路を使用してください。

- 電源回路容量不足や施工不備があると感電、火災の原因になります。

ユニットの端子カバー(パネル)を確実に取付けてください。

- 端子カバー(パネル)の取付けに不備があると、ほこり・水等により、火災・感電の原因になります。

据付けや移設の場合は、機器に表示されている冷媒(R410A)以外の異なった冷媒を入れないでください。

- 異なった冷媒や空気等が混入すると、冷凍サイクル内が異常となり、破裂等の原因になります。

小部屋へ据付ける場合は万一冷媒が漏れても限界濃度を超えない対策が必要です。

- 限界濃度を超えない対策については、販売店と相談して据付けてください。万一、冷媒が漏洩して限界濃度を超えると酸欠事故の原因になります。

エアコンを移動再設置する場合は、販売店または専門業者にご相談ください。

- 据付けに不備があると水漏れや感電、火災等の原因になります。

設置工事終了後、冷媒ガスが漏れていないことを確認してください。

- 冷媒ガスが室内に漏れ、ファンヒーター、ストーブ、コンロなどの火気に触れると、有毒ガスが発生する原因になります。

保護装置の改造や設定変更をしないでください。

- 圧力開閉器や温度開閉器等の保護装置を短絡して強制的運転を行ったり、当社指定品以外のもを使用すると、火災や爆発の原因になります。

# 冷媒R410A使用機器としての注意点

## ⚠注意

既設の冷媒配管を流用しないでください。

- 既設の配管内部には、従来の冷凍機油や冷媒中の塩素が大量に含まれ、これらの物質が新しい機器の冷凍機油劣化等の原因になります。
- R410Aは高圧冷媒のため配管の破裂等の原因になります。

冷媒配管はJIS H3300「銅及び銅合金継目無管」のC1220のリン脱酸銅を使用してください。また、管の内外面は美麗であり、使用上有害なイオウ、酸化物、ゴミ、切粉、油脂、水分等（コンタミネーション）の付着がないことを確認してください。

- 冷媒配管の内部にコンタミネーションの付着があると、冷凍機油劣化等の原因になります。

据付けに使用する配管は屋内に保管し、両端とも口ウ付する直前までシールしておいてください。（エルボ等の継手はビニール袋等に包んだ状態で保管）

- 冷媒回路内にほこり、ゴミ、水分が混入しますと、油の劣化・圧縮機故障の原因になります。

フレア・フランジ接続部に塗布する冷凍機油は、エステル油又はエーテル油又はアルキルベンゼン（少量）を使用してください。

- 鉱油が多量に混入すると、冷凍機油劣化の原因になります。

液冷媒にて封入してください。

- ガス冷媒で封入するとボンベ内冷媒の組成が変化し、能力不足等の原因になります。

逆流防止器付真空ポンプを使用してください。

- 冷媒回路内に真空ポンプ油が逆流し、機器の冷凍機油劣化等の原因になります。

従来の冷媒に使用している下記に示す工具類は使用しないでください。R410A専用の工具を使用してください。

（ゲージマニホールド・チャージホース・ガス漏れ検知器・逆流防止器・冷媒チャージ用口金・真空度計・冷媒回収装置）

- 従来の冷媒・冷凍機油が混入しますと、冷凍機油劣化の原因になります。
- 水分が混入しますと、冷凍機油劣化の原因になります。
- 冷媒中に塩素を含まないため、従来の冷媒用ガス漏れ検知器では反応しません。

チャージングシリンダーを使用しないでください。

- チャージングシリンダーを使用すると冷媒の組成が変化し、能力不足等の原因になります。

工具類の管理は従来以上に注意してください。

- 冷媒回路内にほこり、ゴミ、水分等が混入しますと、冷凍機油劣化の原因になります。

R410A以外の冷媒は使用しないでください。

- R410A以外（R22等）を使用すると、塩素により冷凍機油劣化等の原因になります。

# 据付けをする前に

## ⚠️注意

可燃性ガスの漏れるおそれがある場所への設置は行わないでください。

- 万一、ガスが漏れてユニットの周囲にたまると、発火の原因になります。

食品・動植物・精密機器・美術品の保存等、特殊用途には使用しないでください。

- 食品の品質低下等の原因になります。

特殊環境には、使用しないでください。

- 油・蒸気・硫化ガスなどの多い場所で使用しますと、性能を著しく低下させたり、部品が破損することがあります。

病院、通信事業所などに据付けされる場合は、ノイズに対する備えを十分に行って施工してください。

- インバーター機器、自家発電機、高周波医療機器、無線通信機器の影響によるエアコンの誤動作や故障の原因になったり、エアコン側から医療機器あるいは通信機器へ影響を与え、人体の医療行為を妨げたり、映像放送の乱れや雑音などの弊害の原因になります。

濡れて困るものの上にユニットを据付けしないでください。

- 湿度が80%を超える場合やドレン出口が詰まっている場合は、室内ユニットからも露が落ちる場合もあります。また、室外ユニットからもドレンが垂れますので必要に応じて、室外ユニットも集中排水工事をしてください。

# 据付け(移設)・電気工事をする前に

## ⚠️注意

アースを行ってください。

- アース線は、ガス管、水道管、避雷針、電話のアース線に接続しないでください。アースが不完全な場合は、感電およびノイズによる誤動作の原因になります。

電源配線は、張力がかからないように配線工事をしてください。

- 断線したり、発熱・火災の原因になります。

電源には漏電遮断器を必ず取付けてください。

- 漏電遮断器が取付けられていないと感電の原因になります。

電源配線は、電流容量、規格品の配線にて工事をしてください。

- 漏電や発熱・火災の原因になります。

正しい容量のブレーカーやヒューズ以外は使用しないでください。

- 大きな容量のヒューズや針金・銅線を使用すると故障や火災の原因になります。

長期使用で据付台等が傷んでないか注意してください。

- 傷んだ状態で放置するとユニットの落下につながり、けが等の原因になります。

ドレン配管は、据付説明書に従って確実に排水するよう配管し、結露が生じないように保温してください。

- 配管工事に不備があると、水漏れし、家財等を濡らす原因になります。

エアコンを水洗いしないでください。

- 感電の原因になります。

# 据付け(移設)・電気工事をする前に

## ⚠️注意

製品の運搬には、十分注意してください。

- 20kg以上の製品の運搬は、1人でしないでください。
- 製品によってはPPバンドによる梱包を行っていますが、危険ですので運搬の手段に使用しないでください。
- 熱交換器のフィン表面で切傷する場合がありますので、素手で触れないように注意してください。
- 室外ユニットの搬入を行う場合は、ユニットベースの指定位置にて吊下げてください。また、適宜、室外ユニットが横ずれしないよう固定し、確実に4点支持で実施してください。3点支持等で運搬・吊下げしますと不安定となり、落下の原因になります。

梱包材の処理は確実に行ってください。

- 梱包材には「クギ」等の金属あるいは、木片等を使用していますので放置状態にしますと「さし傷」などの原因になります。
- 包装用のポリフクロで子供が遊ばないように、破いてから廃棄してください。窒息事故等の原因になります。

# 試運転をする前に

## ⚠️注意

運転を開始する12時間以上前に電源を入れてください。

- 故障の原因になります。シーズン中は電源を切らないでください。

運転停止後、すぐに電源を切らないでください。

- 必ず5分以上待ってください。水漏れや故障の原因になります。

運転中にパネルやガードを外したまま運転しないでください。

- 機器の回転物、高温部、高電圧に触れると巻込まれたり、火傷や感電によりケガの原因になります。

運転中および運転停止直後の冷媒配管、冷媒回路部品に素手で触れないでください。

- 運転中、停止直後の冷媒配管や圧縮機などの冷媒回路部品は、流れる冷媒の状態により低温、高温になります。素手で触れると、凍傷や火傷になるおそれがあります。

濡れた手でスイッチを操作しないでください。

- 感電の原因になります。

# R410A冷媒の使用について

## (1) 工具類

シティマルチY<sup>ECO</sup>新冷媒R410Aシリーズでは、工事およびサービスを行うにあたって、次の工具(機材)を準備する必要があります。

### 【R410A用ツール(R22、R407C機種用品の使用可否一覧)】

新規に準備が必要なツール・材料(R22、R407C機種用品とは共用不可)

ツール・材料	用途	備考
ゲージマニホールド	真空引き、冷媒充てん	高圧側圧力5.09MPa以上
チャージホース	真空引き、冷媒充てん	ホース径が従来機種より大きくなっています。
冷媒回収器	冷媒の回収	
冷媒ポンペ	冷媒の充てん	冷媒名記載、ポンペ上部ピンク色
冷媒ポンペ用チャージ口	冷媒の充てん	ホース接続部の径が従来より大きくなっています。
フレアナット	機器と配管の接続	2種のフレアを使用してください。 (JIS B 8607 適合品を使用してください。)

一部条件はあるが使用可能なツール・材料

ツール・材料	用途	備考
ガス漏れ検知器	ガス漏れチェック	HFC系冷媒対応であれば使用可
真空ポンプ	真空乾燥	逆流防止アダプターを取付ければ使用可
フレアツール	配管のフレア加工	フレア加工寸法に変更あります、次ページ参照願います。

従来機種(R22、R407C)用品と共用可能なツール

ツール・材料	用途	備考
逆流防止付き真空ポンプ	真空乾燥	
ベンダー	配管の曲げ加工	
トルクレンチ	フレアナットの締付け	12.70(1/2") 15.88(5/8")のみフレア寸法が大きくなっています。
パイプカッター	配管の切断	
溶接機・窒素ポンペ	配管の溶接	
冷媒充てんはかり	冷媒充てん	
真空計	真空度確認	

使用禁止ツール

ツール・材料	用途	備考
チャージリングシリンダー	冷媒充てん	使用禁止

工具類の管理は厳しく実施し、水分・ゴミ等が入り込まないように注意してください。

## (2) 配管材料

### 既設配管の流用禁止！

新しい配管

既設配管

#### 銅管の質別

○材	軟質銅管（なまし銅管）やわらかく手でも曲げることが可能です。
1/2H材	硬質銅管（直管）硬い配管ですが、○材と比較して同じ肉厚でも強度があります。

- ・ ○材、1/2H材とは、銅配管自体の強度により質別します。
- ・ ○材は、やわらかく手でも曲げることが可能です。
- ・ 1/2H材は硬い管ですが、○材と同じ肉厚でも強度が大幅にあります。

#### 銅管の種別 (JIS B 8607)

種別	最高使用圧力	冷媒対象
1種	3.45MPa	R22,R407Cなど
2種	4.30MPa	R410Aなど
3種	4.80MPa	————

#### 配管材料・肉厚

冷媒配管は、JISH3300「銅、及び銅合金断目無管」のC1220のりん脱酸銅を使用してください。

R410AはR22に比べて作動圧力が上がるため、必ず下記肉厚以上のものを使用してください。（肉厚0.7mmの薄肉品の使用は禁止）

サイズ(mm)	呼び	肉厚(mm)	種別
6.35	1/4"	0.8t	○材
9.52	3/8"	0.8t	
12.7	1/2"	0.8t	
15.88	5/8"	1.0t	
19.05	3/4"	1.0t	1/2H材 またはH材
22.2	7/8"	1.0t	
25.4	1"	1.0t	
28.58	1 1/8"	1.0t	
31.75	1 1/4"	1.1t	
38.1	1 1/2"	1.35t	

従来の機種においては、19.05(3/4")までのサイズでは、○材を使用していましたがR410A機種では1/2H材を使用してください。

(19.05で肉厚1.2tであれば○材も使用できます。)

配管材料への表示

新冷媒対応の配管部材は断熱材表面に「銅管肉厚」「対応冷媒」の記号が表示されています。

配管肉厚の表示 (mm)

肉厚	記号表示
0.8	08
10	10

対応冷媒表示

対応冷媒	記号表示
1種 R22,R407C	
2種 R410A	

<断熱材への表示例>

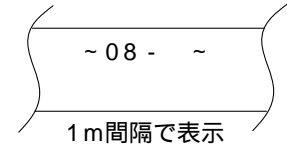

梱包外装でも識別できるように、表示されてますので確認してください。

<外装ケースの表示例>

	: 1種、2種兼用タイプ
対応冷媒	: R22,R407C,R410A
銅管口径×肉厚	: 9.52×0.8、15.88×1.0

フレア加工 (0材,OL材のみ)

R410Aのフレア加工寸法は、より気密性を増すために、R22より大きくなります。

フレア加工寸法(mm)

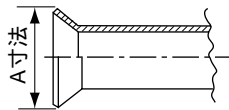

配管外形	呼び	A寸法	
		R410A	R22
6.35	1/4"	9.1	9.0
9.52	3/8"	13.2	13.0
12.70	1/2"	16.6	16.2
15.88	5/8"	19.7	19.4
19.05	3/4"	24.0	23.3

( 19.05では、肉厚1.2tの0材をご使用ください。 )

従来のフレアツール(クラッチ式)を使用してR410Aのフレア加工を行う場合は、配管の出し代を1.0~1.5mmとして加工すれば規定の寸法になります。

また、出し代調整用の銅管ゲージを使用すると便利です。

フレアナット

フレアナットも強度を増すために、1種から2種へ変更しています。

また、サイズを変更しているものがあります。

フレアナット寸法(mm)

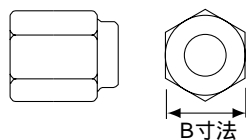

配管外形	呼び	B寸法	
		R410A(2種)	R22(1種)
6.35	1/4"	17.0	17.0
9.52	3/8"	22.0	22.0
12.70	1/2"	26.0	24.0
15.88	5/8"	29.0	27.0
19.05	3/4"	36.0	36.0



本マニュアルはシティマルチYエコシリーズに限定したものです。

システム設計ならびにシステムコントローラー関連については、別刷「システム設計マニュアル **制御編**」を参照してください。

# 目次

## 安全のために必ず守ること

### ・ 機器概要

- 1 . 機器構成表 ..... 1
- 2 . 室外ユニット概略仕様 ..... 5
- 3 . 運転可能温度範囲 ..... 5
- 4 . 室内ユニット概略仕様 ..... 6
- 5 . 機器選定時の注意事項 ..... 7

### ・ 冷媒配管設計

- 1 . 冷媒配管長制限 ..... 10
- 2 . 冷媒配管の選定 ..... 13
- 3 . 冷媒漏洩による注意事項 ..... 15
  - (1)はじめに
  - (2)限界濃度確認手順
  - (3)限界濃度を越えた場合の対応

### ・ 据付スペース

- 1 . 据付場所の選定 ..... 20
- 2 . 据付スペース ..... 21

### ・ 製品仕様

- 1 . 室外ユニット ..... 25
  - (1)仕様表
  - (2)外形図
- 2 . 室内ユニット ..... 37
  - (1)仕様表
  - (2)外形図

### ・ 製品データ

- 1 . 冷房・暖房能力特性 ..... 63
  - (1)システムの冷房・暖房能力の求め方
  - (2)室内ユニット1台の冷房・暖房能力の求め方
  - (3)標準能力表および能力補正
- 2 . 室外ユニットの騒音 ..... 159
- 3 . 送風機特性線図 ..... 169
- 4 . 外気取入風量特性線図 ..... 180
- 5 . 分ダクト風量特性線図 ..... 182
- 6 . 温度・気流分布 ..... 191
- 7 . 室内ユニットの騒音 ..... 198
  - (1)騒音レベル
  - (2)NC曲線

- 8 . 重心位置 ..... 225
  - (1)室外ユニット
  - (2)室内ユニット
- 9 . 耐震強度計算 ..... 231
  - (1)耐震強度計算書フォーム
  - (2)耐震強度計算
- 10 . 室外ユニットの振動レベル ..... 234

### ・ 据付工事

- 1 . 室外ユニットの据付け ..... 236
  - (1)製品の吊下げ方法
  - (2)据付け
  - (3)アンカーボルト位置
  - (4)下配管・下配線時の注意
  - (5)冷媒配管取出し方向
- 2 . 雪・季節風に対する注意 ..... 245
  - (1)寒冷地域・積雪地域での  
防風・防雪対策
- 3 . 冷媒配管工事 ..... 247
  - (1)注意事項
  - (2)冷媒追加充てん量の算出方法
  - (3)配管接続・バルブ操作のご注意
  - (4)分岐管の据付要領
  - (5)気密試験・真空引き・冷媒充てん
  - (6)冷媒配管の断熱
- 4 . 電気工事 ..... 260
  - (1)配線設計にあたって
  - (2)主電源の配線太さおよび開閉器容量
  - (3)制御箱および配線接続位置
  - (4)基本システムの機外配線図例
- 5 . 試運転 ..... 275
  - (1)試運転前の確認事項
  - (2)試運転方法
  - (3)試運転時の不具合対応
  - (4)リモコンの動作不具合内容と処置
  - (5)次の現象は故障（異常）ではありません

# 機器概要

## 1. 機器構成表

5 ~ 14HP

室外ユニット		5HP	6HP	8HP	10HP	12HP	13HP	14HP
		PUHY-P140M-E	PUHY-P160M-E	PUHY-P224M-E	PUHY-P280M-E	PUHY-P335M-E	PUHY-P335M-E	PUHY-P400M-E
接続可能	容量	P 22 ~ P 160		P 22 ~ P 280		P 22 ~ P 280	P 22 ~ P 450	
	台数	1 ~ 8台	1 ~ 9台	1 ~ 13台	1 ~ 16台	1 ~ 16台		1 ~ 20台
室内ユニット	合計容量 <small>(室外ユニット容量比)</small>	70 ~ 182 (50 ~ 130%)	80 ~ 208 (50 ~ 130%)	112 ~ 291 (50 ~ 130%)	140 ~ 364 (50 ~ 130%)	168 ~ 435 (50 ~ 130%)	178 ~ 461 (50 ~ 130%)	200 ~ 520 (50 ~ 130%)

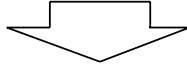

分岐管キット	分岐ジョイント		分岐ヘッダー		
			4分岐	8分岐	10分岐
	5・6HP	CMY-Y102S-D	CMY-Y104-D	CMY-Y108-D	—
8HP	CMY-Y102S-D				
10・12HP	CMY-Y102S-D CMY-Y102L-D	CMY-Y1010-D			
13・14HP	CMY-Y102S-D CMY-Y102L-D CMY-Y202-D				

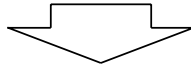

					P22	P28	P36	P45	P56	P71	P80	P90	P112	P140	P160	P224	P280	P450		
汎用	パネル必要	天井 吊	四方向	PLFY	AM															
			二方向		JM															
			一方向	PMFY	BM															
			外-内-用		CLMD															
	天井	ビルトイン	PDFY	M																
	天袋	ビルトイン	PEFY	AM																
	天埋	ダクト ホテル向け	PEFY	M																
				ML																
	天吊		PCFY	GM																
	壁掛	小容量	PKFY	AM																
				AMS																
		大容量	GM																	
	床置	ローボーイ	PFFY	LEM																
		ダクト		DM																
		スリム	PSFY	GM																
床埋込	ローボーイ	PFFY	LRM																	
厨房用	天吊	PCFY	HM																	
オールラック	天埋	PEFY	M-F																	
	壁	ビルトイン	PFFY	RM-F																
ロスナイ			LGH	RDF4			(50)	(80)	(100)											
			LB	DF4					(100)	(150)	(200)									

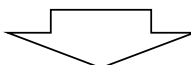

パネル (天井カセット、天井ビルトイン、天袋ビルトインのみ)

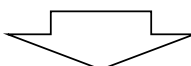

リモコンおよびシステムコントローラー等

16～26HP

室外ユニット		16HP	18HP	20HP	22HP	24HP	26HP
		PUHY-P450M-E	PUHY-P500M-E	PUHY-P560M-E	PUHY-P630M-E	PUHY-P674M-E	PUHY-P730M-E
接続可能	容量	P22～P560					
	台数	1～20台				1～32台	
室内ユニット	合計容量	225～585	250～650	280～728	315～819	337～876	365～949
	(室外ユニット容量比)	(50～130%)	(50～130%)	(50～130%)	(50～130%)	(50～130%)	(50～130%)

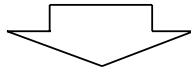

分岐管キット	分岐ジョイント	分岐ヘッダー		
		4分岐	8分岐	10分岐
	CMY-Y102S-D CMY-Y102L-D CMY-Y202-D	CMY-Y104-D	CMY-Y108-D	CMY-Y1010-D

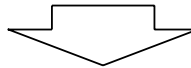

					P22	P28	P36	P45	P56	P71	P80	P90	P112	P140	P160	P224	P280	P450	P560		
汎用	パネル必要	天井カセット	四方向	PLFY	AM																
			二方向		JM																
		一方向	PMFY	BM																	
		カ-ル-ム用		EM																	
		天井	ビルトイン	PDFY	M																
	汎用	天袋	ビルトイン	PEFY	AM																
					M																
		天埋	ダクト ホテル向け	PEFY	M																
					ML																
		天吊		PCFY	GM																
		壁掛	小容量	PKFY	AM																
					AMS																
	壁掛	大容量	PKFY	GM																	
				LEM																	
	床置	ローボーイ ダクト	PFFY	DM																	
GM																					
床埋込	ローボーイ	PFFY	LRM																		
			HM																		
厨房用	天吊		PCFY	HM																	
オールラウンド	天埋		PEFY	M-F																	
	壁	ビルトイン	PFFY	RM-F																	
LGH				RDF4			(50)	(80)	(100)												
ロスナイ			LB	DF4						(100)	(150)	(200)									

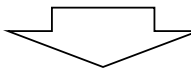

パネル (天井カセット、天井ビルトイン、天袋ビルトインのみ)

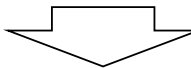

リモコンおよびシステムコントローラー等

28～32HP

室外ユニット		28HP	30HP	32HP
		PUHY-P784SM-E	PUHY-P840SM-E	PUHY-P900SM-E
接続可能	容量	P22～P560		
	台数	1～32台		
室内ユニット	合計容量 <small>(室外ユニット容量比)</small>	392～1019 (50～130%)	420～1092 (50～130%)	450～1170 (50～130%)

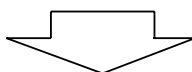

分岐管キット	分岐ジョイント	分岐ヘッダー		
		4分岐	8分岐	10分岐
	CMY-Y102S-D CMY-Y102L-D CMY-Y202-D CMY-Y302-D	CMY-Y104-D	CMY-Y108-D	CMY-Y1010-D

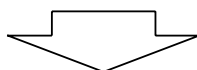

				P22	P28	P36	P45	P56	P71	P80	P90	P112	P140	P160	P224	P280	P450	P560	
汎用	天井 カセット	四方向	PLFY	AM															
				JM															
		二方向	PMFY	LMD															
				BM															
	一方向	PLFY	EM																
			CLMD																
	天井 天袋	ビルトイン	PDFY	M															
			PEFY	AM															
	天埋	ダケ ホテル向け	PEFY	M															
				ML															
	天吊		PCFY	GM															
	壁掛	小容量	PKFY	AM															
				AMS															
	床置	ロボイ ダケ	PFFY	GM															
LEM																			
床埋込	ロボイ	PSFY	DM																
			GM																
厨房用 ウォールマウント	天吊	PFFY	LRM																
			HM																
ウォールマウント	天埋	PEFY	M-F																
			RM-F																
ロスナイ	壁	ビルトイン	PFFY																
			RM-F																
				LGH	RDF4	(50)	(80)	(100)											
				LB	DF4			(100)	(150)	(200)									

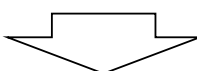

パネル(天井カセット、天井ビルトイン、天袋ビルトインのみ)

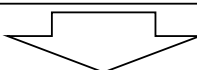

リモコンおよびシステムコントローラー等

34～50HP

室外ユニット		34HP	36HP	38HP	40HP	42HP	44HP	46HP	48HP	50HP
		PUHY-P960SKM-E	PUHY-P1010SKM-E	PUHY-P1080SKM-E	PUHY-P1130SKM-E	PUHY-P1180SKM-E	PUHY-P1240SKM-E	PUHY-P1300SKM-E	PUHY-P1360SKM-E	PUHY-P1400SKM-E
接続可能	容量	P22～P560								
	台数	1～42台								
室内ユニット	合計容量	22～1248	22～1313	22～1404	22～1469	22～1534	22～1612	22～1690	22～1768	22～1820
	(室外ユニット容量比)	(50～130%)	(50～130%)	(50～130%)	(50～130%)	(50～130%)	(50～130%)	(50～130%)	(50～130%)	(50～130%)

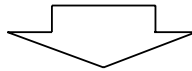

分岐管キット	分岐ジョイント	分岐ヘッダー		
		4分岐	8分岐	10分岐
	CMY-Y102S-D CMY-Y102L-D CMY-Y202-D CMY-Y302-D	CMY-Y104-D	CMY-Y108-D	CMY-Y1010-D

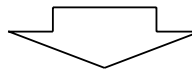

				P22	P28	P36	P45	P56	P71	P80	P90	P112	P140	P160	P224	P280	P450	P560	
汎用	天井カセット	四方向	PLFY	AM															
				JM															
		二方向	PMFY	LMD															
				BM															
	一方向	PLFY	EM																
			CLMD																
	天井	ビルトイン	PDFY	M															
				AM															
	天袋	ビルトイン	PEFY	M															
				ML															
	天埋	ダケ外 ホテル向け	PCFY	GM															
				AM															
	壁掛	小容量	PKFY	AMS															
				GM															
大容量		PFFY	LEM																
			DM																
床置	ロボイ ダケ外	PSFY	GM																
			LRM																
床埋込	ロボイ	PFFY	HM																
			M-F																
厨房用	天吊	PEFY	RM-F																
ウォールマウント	壁	ビルトイン	PFFY																
			RF4																
ロスナイ		LB	DF4			(50)	(80)	(100)											
								(100)	(150)	(200)									

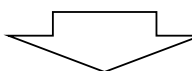

パネル（天井カセット、天井ビルトイン、天袋ビルトインのみ）

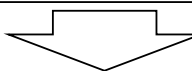

リモコンおよびシステムコントローラー等

## 2. 室外ユニット概略仕様

	PUHY-P140M-E	PUHY-P160M-E	PUHY-P224M-E	PUHY-P280M-E	PUHY-P335M-E
電源	三相 200V ± 10% 50/60Hz				
冷房能力 (kW)	14.0	16.0	22.4	28.0	33.5
暖房能力 (kW)	16.0	18.0	25.0	31.5	37.5
圧縮機用電動機出力 (kW)	2.8	3.3	4.7	6.7	8.0
送風機用電動機出力 (kW)	0.38	0.38	0.38	0.38	0.38

	PUHY-P355M-E	PUHY-P400M-E	PUHY-P450M-E	PUHY-P500M-E	PUHY-P560M-E
電源	三相 200V ± 10% 50/60Hz				
冷房能力 (kW)	35.5	40.0	45.0	50.0	56.0
暖房能力 (kW)	40.0	45.0	50.0	56.0	63.0
圧縮機用電動機出力 (kW)	8.6	9.6	9.7	6.8 + 5.3	8.2 + 5.3
送風機用電動機出力 (kW)	0.38	0.38	0.64	0.38 + 0.38	0.38 + 0.38

	PUHY-P630M-E	PUHY-P674M-E	PUHY-P730M-E	PUHY-P784SM-E	PUHY-P840SM-E
電源	三相 200V ± 10% 50/60Hz				
冷房能力 (kW)	63.0	67.4	73.0	78.4	84.0
暖房能力 (kW)	67.0	75.0	81.5	88.0	94.5
圧縮機用電動機出力 (kW)	9.3 + 5.3	10.1 + 5.3	10.9 + 5.3	8.6 + 8.6	9.4 + 9.4
送風機用電動機出力 (kW)	0.38 + 0.38	0.38 + 0.38	0.38 + 0.38	0.64 + 0.64	0.64 + 0.64

	PUHY-P900SM-E	PUHY-P960SKM-E	PUHY-P1010SKM-E	PUHY-P1080SKM-E	PUHY-P1130SKM-E
電源	三相 200V 50/60Hz				
冷房能力 (kW)	90.0	96.0	101.0	108.0	113.0
暖房能力 (kW)	100.0	108.0	113.0	119.5	127.0
圧縮機電動機出力 (kW)	10.1 + 10.1	$(9.4+5.3) \div (8.5+5.3) \times (8.5+5.3)$	$(10.3+5.3) \div (9.6+5.3) \times (8.5+5.3)$	$(11.2+5.3) \div (10.9+5.3) \times (8.5+5.3)$	$(11.6+5.3) \div (11.6+5.3) \times (8.5+5.3)$
送風機電動機出力 (kW)	0.64 + 0.64	$(0.38+0.38) \times 2$	$(0.38+0.38) \times 2$	$(0.38+0.38) \times 2$	$(0.38+0.38) \times 2$

	PUHY-P1180SKM-E	PUHY-P1240SKM-E	PUHY-P1300SKM-E	PUHY-P1360SKM-E	PUHY-P1400SKM-E
電源	三相 200V 50/60Hz				
冷房能力 (kW)	118.0	124.0	130.0	136.0	140.0
暖房能力 (kW)	132.0	140.0	145.0	150.0	156.5
圧縮機電動機出力 (kW)	$(11.6+5.3) \div (11.6+5.3) \times (8.5+5.3)$	$(9.4+5.3) \div (8.5+5.3) \times (11.6+5.3)$	$(10.3+5.3) \div (9.6+5.3) \times (11.6+5.3)$	$(11.2+5.3) \div (10.9+5.3) \times (11.6+5.3)$	$(11.6+5.3) \div (11.6+5.3) \times (11.6+5.3)$
送風機電動機出力 (kW)	$(0.38+0.38) \times 2$	$(0.38+0.38) \times 2$	$(0.38+0.38) \times 2$	$(0.38+0.38) \times 2$	$(0.38+0.38) \times 2$

(注)冷房・暖房能力は、JIS8615-1又は2の条件で運転した場合の最大能力です。

## 3. 運転可能温度範囲

シリーズ名		冷房時		暖房時	
ECO	標準	室内吸込空気温度	湿球温度 15 ~ 24	乾球温度 15 ~ 27	
		室外吸込空気温度	乾球温度 -5 ~ 43 注.1	湿球温度 -20 ~ 15.5	
	オールフレッシュ	室内吸込空気温度	湿球温度 15 ~ 35 注.2	乾球温度 -10 ~ 20 注.2	
		室外吸込空気温度	乾球温度 21 ~ 43	湿球温度 -12.5 ~ 20	

(注1) 室外ユニット下設置の場合、乾球温度 10 ~ 43 になります。

(注2) オールフレッシュ室内ユニットは本体内蔵のサーモにより、冷房時 21 (乾球温度) 以下、暖房時 20 (乾球温度) 以上でサーモOFFします。

## 4.室内ユニット概略仕様

種 類	形 名	冷房能力(kW)	暖房能力(kW)
天井カセット形 (四方向吹出し) パワーカセット	PLFY-P22AM-E1	2.2	2.5
	PLFY-P28AM-E1	2.8	3.2
	PLFY-P36AM-E1	3.6	4.0
	PLFY-P45AM-E1	4.5	5.0
	PLFY-P56AM-E1	5.6	6.3
	PLFY-P71AM-E1	7.1	8.0
	PLFY-P80AM-E1	8.0	9.0
	PLFY-P90AM-E1	9.0	10.0
	PLFY-P112AM-E1	11.2	12.5
	PLFY-P140AM-E1	14.0	16.0
天井カセット形 (四方向吹出し) コンパクトタイプ	PLFY-P36JM-E1	3.6	4.0
	PLFY-P45JM-E1	4.5	5.0
	PLFY-P56JM-E1	5.6	6.3
	PLFY-P71JM-E1	7.1	8.0
天井カセット形 (二方向吹出し)	PLFY-P22LMD-E1	2.2	2.5
	PLFY-P28LMD-E1	2.8	3.2
	PLFY-P36LMD-E1	3.6	4.0
	PLFY-P45LMD-E1	4.5	5.0
	PLFY-P56LMD-E1	5.6	6.3
	PLFY-P71LMD-E1	7.1	8.0
	PLFY-P80LMD-E1	8.0	9.0
	PLFY-P90LMD-E1	9.0	10.0
天井カセット形 (二方向吹出し) 電気ヒーター付	PLFY-P22LMDH-E1	2.2	2.5(3.2)
	PLFY-P28LMDH-E1	2.8	3.2(3.9)
	PLFY-P36LMDH-E1	3.6	4.0(4.7)
	PLFY-P45LMDH-E1	4.5	5.0(5.7)
	PLFY-P56LMDH-E1	5.6	6.3(7.1)
	PLFY-P71LMDH-E1	7.1	8.0(8.8)
	PLFY-P80LMDH-E1	8.0	9.0(9.8)
	PLFY-P90LMDH-E1	9.0	10.0(10.8)
天井カセット形 (一方向吹出し) 小容量タイプ	PMFY-P22BM-E1	2.2	2.5
	PMFY-P28BM-E1	2.8	3.2
	PMFY-P36BM-E1	3.6	4.0
	PMFY-P45BM-E1	4.5	5.0
天井カセット形 (一方向吹出し) 大容量タイプ	PMFY-P36EM-E1	3.6	4.0
	PMFY-P45EM-E1	4.5	5.0
	PMFY-P56EM-E1	5.6	6.3
	PMFY-P71EM-E1	7.1	8.0
天井ビルトイン形	PDFY-P22M-E1	2.2	2.5
	PDFY-P28M-E1	2.8	3.2
	PDFY-P36M-E1	3.6	4.0
	PDFY-P45M-E1	4.5	5.0
	PDFY-P56M-E1	5.6	6.3
	PDFY-P71M-E1	7.1	8.0
	PDFY-P80M-E1	8.0	9.0
	PDFY-P90M-E1	9.0	10.0
天袋埋込ビルトイン形	PEFY-P22AM-E1	2.2	2.5
	PEFY-P28AM-E1	2.8	3.2
	PEFY-P36AM-E1	3.6	4.0
	PEFY-P45M-E1	4.5	5.0
天井埋込形	PEFY-P56M-E1	5.6	6.3
	PEFY-P71M-E1	7.1	8.0
	PEFY-P80M-E1	8.0	9.0
	PEFY-P90M-E1	9.0	10.0
	PEFY-P112M-E1	11.2	12.5
	PEFY-P140M-E1	14.0	16.0
	PEFY-P140M-E1	14.0	16.0

種 類	形 名	冷房能力(kW)	暖房能力(kW)
天井埋込形	PEFY-P160M-E1	16.0	18.0
	PEFY-P224M-E1	22.4	25.0
	PEFY-P280M-E1	28.0	31.5
天吊形	PCFY-P45GM-E1	4.5	5.0
	PCFY-P56GM-E1	5.6	6.3
	PCFY-P71GM-E1	7.1	8.0
	PCFY-P80GM-E1	8.0	9.0
	PCFY-P90GM-E1	9.0	10.0
	PCFY-P112GM-E1	11.2	12.5
	PCFY-P140GM-E1	14.0	16.0
	PCFY-P160GM-E1	16.0	18.0
	壁掛形 1 (小容量タイプ)	PKFY-P22AM(S)-E1	2.2
PKFY-P28AM(S)-E1		2.8	3.2
壁掛形 (大容量タイプ)	PKFY-P36GM-E1	3.6	4.0
	PKFY-P45GM-E1	4.5	5.0
	PKFY-P56GM-E1	5.6	6.3
床置形 (ローボーイ)	PFFY-P28LEM-E1	2.8	3.2
	PFFY-P36LEM-E1	3.6	4.0
	PFFY-P45LEM-E1	4.5	5.0
	PFFY-P56LEM-E1	5.6	6.3
	PFFY-P71LEM-E1	7.1	8.0
床置形	PFFY-P224DM-E1	22.4	25.0
	PFFY-P280DM-E1	28.0	31.5
	PFFY-P450DM-E1	45.0	56.0
	PFFY-P560DM-E1	56.0	63.0
床置形 (スリム)	PSFY-P56GM-E1	5.6	6.3
	PSFY-P71GM-E1	7.1	8.0
	PSFY-P80GM-E1	8.0	9.0
	PSFY-P112GM-E1	11.2	12.5
	PSFY-P140GM-E1	14.0	16.0
	PSFY-P160GM-E1	16.0	18.0
壁ビルトイン形	PFFY-P112RM-E1	11.2	10.6
	PFFY-P140RM-E1	14.0	13.2
	PFFY-P224RM-E1	22.4	25.0
	PFFY-P280RM-E1	28.0	31.5
床置埋込形 (ローボーイ)	PFFY-P28LRM-E1	2.8	3.2
	PFFY-P36LRM-E1	3.6	4.0
	PFFY-P45LRM-E1	4.5	5.0
	PFFY-P56LRM-E1	5.6	6.3
	PFFY-P71LRM-E1	7.1	8.0
天井埋込形 (ホテル向け)	PEFY-P22ML-E(R)	2.2	2.5
	PEFY-P28ML-E(R)	2.8	3.2
天井埋込形 オールフレッシュ 2	PEFY-P90M-E1-F	9.0	8.5
	PEFY-P112M-E1-F	11.2	10.6
	PEFY-P140M-E1-F	14.0	13.2
	PEFY-P160M-E1-F	16.0	15.1
	PEFY-P224M-E1-F	22.4	21.2
	PEFY-P280M-E1-F	28.0	26.5
壁ビルトイン形 オールフレッシュ 2	PFFY-P280RM-E1-F	28.0	26.5
	天吊形 厨房用	PCFY-P80HM-E1	8.0
天井カセット形 クリーンルーム用	PLFY-P36CLMD-E1	3.6	4.0
	PLFY-P45CLMD-E1	4.5	5.0
	PLFY-P56CLMD-E1	5.6	6.3
	PLFY-P71CLMD-E1	7.1	8.0
	PLFY-P80CLMD-E1	8.0	9.0
ロスナイ	LGH-50RDF4	5.46	6.18
	LGH-80RDF4	8.79	10.11
	LGH-100RDF4	11.17	12.50
	LB-100DF4	10.36	11.59
	LB-150DF4	13.06	14.49
	LB-200DF4	15.83	17.43

注. 室内ユニットの冷房・暖房能力はJIS8615-1又は2の標準条件で運転した場合の値です。

注. 1の壁掛形のPKFY-AMS-E1形は、静かな小部屋用を示します。ホテル、寮などの暗騒音が低い部屋でのご使用には、PKFY-AMS-E1形をご選定ください。なお、その際には必ず別売外付LEVボックスPAC-SG95LEとの組合せ使用となります。

注. 2の冷房・暖房能力は、<冷房時:室内側吸込空気温度33(乾球温度)、28(湿球温度)、室外側吸込空気温度33(乾球温度)、28(湿球温度)、暖房時:室内側吸込空気温度0(乾球温度)、-2.9(湿球温度)、室外側吸込空気温度0(乾球温度)、-2.9(湿球温度)>によります。

注.( )内数値はヒーター付機種でのヒーター作動時の値です。

注. ロスナイの冷暖能力は外気負荷熱処理能力(冷房室内側吸込温度27(乾球温度)、19(湿球温度)、室外側吸込温度35(乾球温度)、24(湿球温度)、暖房室内側吸込温度20(乾球温度)、13.8(湿球温度)、室外側吸込温度7(乾球温度)、6(湿球温度))を示し、ロスナイによる熱回収分を含めた値です。



## 5. 機器選定時の注意事項

### ・冷媒の流動音

注意事項	対応方法
<p>ホテル、寮、会議室などの暗騒音が低い部屋での使用の場合には、わずかながら冷媒の流動音が懸念される場合があります。 (異常ではありません) 特に上記のような場所への壁掛形設置の場合には、念のため右記の対応を実施してください。</p>	<p>壁掛形PKFY-AM-Eの場合は、PKFY-AMS-E(静かな小部屋用)を選定してください。 なお、この特別売の外付けLEVボックスPAC-SG95LEを必ず併せてご使用ください。 壁掛形以外の室内ユニットについて、冷媒の流動音が懸念される場合には、ご相談ください。</p>

### ・暖房運転以外での室温上昇

注意事項	対応方法
<p>暖房時、サーモOFF中の室内ユニットからわずかながら温風が出る場合があります。 (異常ではありません) 小部屋で気密性の高い部屋の場合など、その温風による室温上昇が懸念される場合には、据付け時に右記のいずれかの対応を実施してください。  (注) R2タイプはサーモOFF時温風は出ません。</p>	<p>以下のいずれかの対応を実施してください。 但し、リモコンは室内温度を検知できるところへ取付けてください。 (温風・冷風の影響を受けないところ) サーモOFF時にファン停止できる場合 室内ユニット制御基板上のSW1-7, 1-8をONにする サーモOFF時にファン停止します。 サーモOFF時にファン停止できない場合 (例えば、クリーンルーム用など) 室内ユニット制御基板上のSW3-7をONにする サーモOFF時にLEVを全閉にします ただし、LEV制御の設定変更する室内ユニットの合計容量は、室外ユニット容量の50%以下となるようにしてください。 (全室内ユニットのLEV制御設定を変更することは不可)</p>

### ・低外気時の吹出温度の低下

注意事項	対応方法
<p>暖房運転中において外気温度が低い条件や室内ユニットの吸込温度が低い条件では、暖房能力がカタログの記載能力よりも低下します。</p>	<p>技術資料などで必要暖房能力が確保できるか、ご検討いただき、機器・容量およびシステム選定ください。</p>

### ・分流コントローラーの冷媒音

注意事項	対応方法
<p>ホテル、寮、会議室などの暗騒音が低い部屋での使用の場合には、わずかながら冷媒の流動音が懸念される場合があります。 (異常ではありません) 特に上記のような静粛性が要求されるような場所への設置は、避けてください。</p>	<p>ユニットから発生する冷媒音の影響のない場所(廊下、給湯室、トイレなど常時人が滞在しない場所)の天井裏、もしくは同じように冷媒音が問題とならないサービススペースに設置してください。</p>

### ・室外ユニット騒音

注意事項	対応方法
<p>室外ユニットの製品仕様表に記載の騒音値は、無響音室にて測定した倍の値です。 従って、現地での据付け環境、および反響によって騒音値は大きく影響されますので注意が必要です。</p>	<p>通常の住宅地など静粛性が要求されるような居住地域への隣接設置は避けてください。 設置環境において、騒音の影響が懸念される場合には、ご相談ください。</p>

・デフロスト運転時の暖房能力への影響

注意事項	対応方法
暖房運転中には外気が低下(湿球温度約6 以下)すると、室外ユニットの熱交換器に霜がついて性能が低下し、また霜を除去するためのデフロスト運転に入ることがあります。(異常ではありません)	後述の「 . 製品データ」の「1. 冷房・暖房能力特性」項の能力補正に従って、負荷見積りを実施してください。  暖房能力には以下の補正が必要です。 ・空気条件変化による補正×配管長補正×デフロスト補正
デフロスト復帰後には、デフロストによるガス配管の冷却などの要因により、そのデフロスト時間が長くなる(熱交換器の霜が多い、もしくは外風が室外ユニットに吹きつけている)ほど、暖房能力の立ち上がりが悪くなる場合があります。 (性能復帰まで最長10～20分)	外風対策、防雪対策を実施してください。 (P245を参照してください)
クリーンルーム用などの室内クリーン度が要求される室内ユニットの場合、デフロスト中においても送風FAN運転(弱風)しているため、デフロスト中(通常5～10分間、最長15分間)に室温が低下することがあります。デフロスト中の室内クリーン度よりも室温低下の方を重視される場合、右記の対応を実施してください。	クリーンルーム用のPLFY-CLMD機種の場合、以下の対応を実施してください。 室内ユニット制御基板上のSW3-5をOFFにする 他機種の室内ユニットと同様、デフロスト中の送風FANを停止させます。

・ドライ運転時の室温冷え過ぎ

注意事項	対応方法
ドライ運転では、室温に応じて発停運転を行うため、設定温度に対して若干室温が低下しすぎることがあります。(異常ではありません)また、室温が18 以下になると常時サーモOFFとなります。 ドライ運転時に室温の低下が懸念される場合には、右記の対応を実施してください。	室温検知サーモを人の感じる温度に近いリモコンサーモ、もしくは室温サーモに変更する。室内ユニット制御基板上のSW1-1をONにする。

・ノイズの影響について

注意事項	対応方法
空調機はマイコンを使用しておりますので、わずかながら電源、伝送線、本体から放射ノイズを出しております。電氣的に微細な信号を増幅するような機器(ワイヤレスマイク、医療機器等)の近傍に据付けた場合、これらの機器がノイズの影響を受け、誤動作を起こす場合があります。また、強いノイズを発生させる機器(放電加工機等)の近傍に空調機を据付けられた場合、これらの発生するノイズにより空調機が誤動作する場合も考えられます。これらが予め懸念される場合は、右記の対応を実施してください。	ノイズの影響を受けやすい機器(ワイヤレスマイクの受信器やアンテナ等)は、できる限りユニットの伝送線、電源線ならびに本体から離して設置してください。 強いノイズを発生させる機器の電源線とは空調機電源と分離し、伝送線、電源線、ユニット本体はできる限り分離して設置してください。

・冷房時の凍結防止運転について

注意事項	対応方法
冷房運転時、室内ユニット熱交換器が凍結することを防止するため、一定時間運転後に配管温度に応じて強制サーモOFFさせる運転(凍結防止運転)を行うことがあり、サーモOFF中は負荷に応じて室温が上昇することがあります。 空冷式室外ユニットの場合は、外気温の低下により凍結防止運転が発生することがあります。発生範囲の目安は運転している室内ユニットの容量に応じて以下のとおりとなります。 ・冷暖切替タイプの場合：最小容量時外気25 以下、最大容量時外気15 以下 ・冷暖同時タイプの場合：最小容量時外気5 以下、容量50%以上の場合-5 (容量50%を超えると発生しにくくなります)	左記目安となる外気温で冷房運転される場合、サーモOFFによる室温変化が許容されない用途へのご使用は避けてください。 特に対物空調などの特殊用途対応の空調をご検討の際には、設備用空調機のご検討をお願いします。

・循環水の水質管理（WR2, WYシリーズ）

注意事項	対応方法
開放式冷却塔を使用したり、循環水の水質が悪い場合は、水側熱交換器にスケールが付着し、熱交換能力の減少や熱交換器を腐食させるおそれがあります。	循環水冷却塔は、水質維持のため密閉式を使用してください。また、定期的な水質管理を行ってください。水質管理方法および水質基準値は、日本冷凍空調工業会基準「冷凍空調機器用水質ガイドライン」（JRA-GL-02）に従ってください。

・加湿器

注意事項	対応方法
暖房負荷が小さい環境で加湿器をご使用になる場合、室内温度が設定温度以上に上昇し、サーモOFFすると加湿能力は著しく低下します。	暖房負荷の小さい環境ではサーモOFF時を想定して必要加湿量をご確認ください。
湿度に関して設計仕様等でビル管理法相当の要求がある場合、室内ユニットに組込む加湿器だけではビル管理法を満足させることは困難です。	室内ユニットに組込む加湿器だけで条件が満たせるか否か事前にご確認ください。
自然蒸発式加湿器をご使用の場合、給水用の水にシリカ分を多く含んでいると、白い粉が吹出すことがあります。	現地にて純水器または軟水器の取付けをおすすめします。

・オールフレッシュ

注意事項	対応方法
オールフレッシュ室内ユニットは室温サーモにより、サーモON/OFFします。また、室内ユニット吸込空気乾球温度(外気温度センサー検知温度)が冷房時21以下、暖房時20以上で、強制サーモOFF(送風状態)になります。サーモOFFすると外気が直接室内に吹出しますので、特に低外気時の冷風吹出しにご注意ください。外気が未処理で室内に入り、室内の温湿度が大きく変化する場合があります。また、外気が人体や食品に直接あたると、外気温度によっては健康障害や食品劣化等の原因になります。また、外気温度と室内温度によっては、室内が結露するおそれがあります。	<ul style="list-style-type: none"> <li>・室内ユニットの吹出空気が人体や食品に直接あたらないように吹出口を設置してください。</li> <li>・オールフレッシュタイプ以外の空調機を併用してください。</li> <li>・室内が結露しないように適宜断熱処理を施してください。</li> <li>・室温サーモ（リモコンまたは温度センサー）を部屋の代表温度を検知できる位置に設置してください。</li> </ul>
室内ユニット吸込空気乾球温度（外気温度センサー検知温度）が5 以下の場合には、加湿器凍結防止・冷風感防止のため、強制的に暖房運転することがあります。また、異常時・除霜時はファンが停止します。	加湿器を搭載しない場合や、暖房時に冷風吹出しの影響を受けない場合はスイッチ設定によりファン運転可能です。室内ユニット制御基板上のSW1-7をOFFにしてください。除霜時はファン停止します。

・運転電流について

注意事項	対応方法
運転電流は、室内負荷、外気温度条件、電源電圧等によって定格値より増加することがあります。	電源設備の選定などに用いる機器の最大電流値は定格値の1.4倍を目安としてください。

# 冷媒配管設計

## 1.冷媒配管長制限

P140～P730形

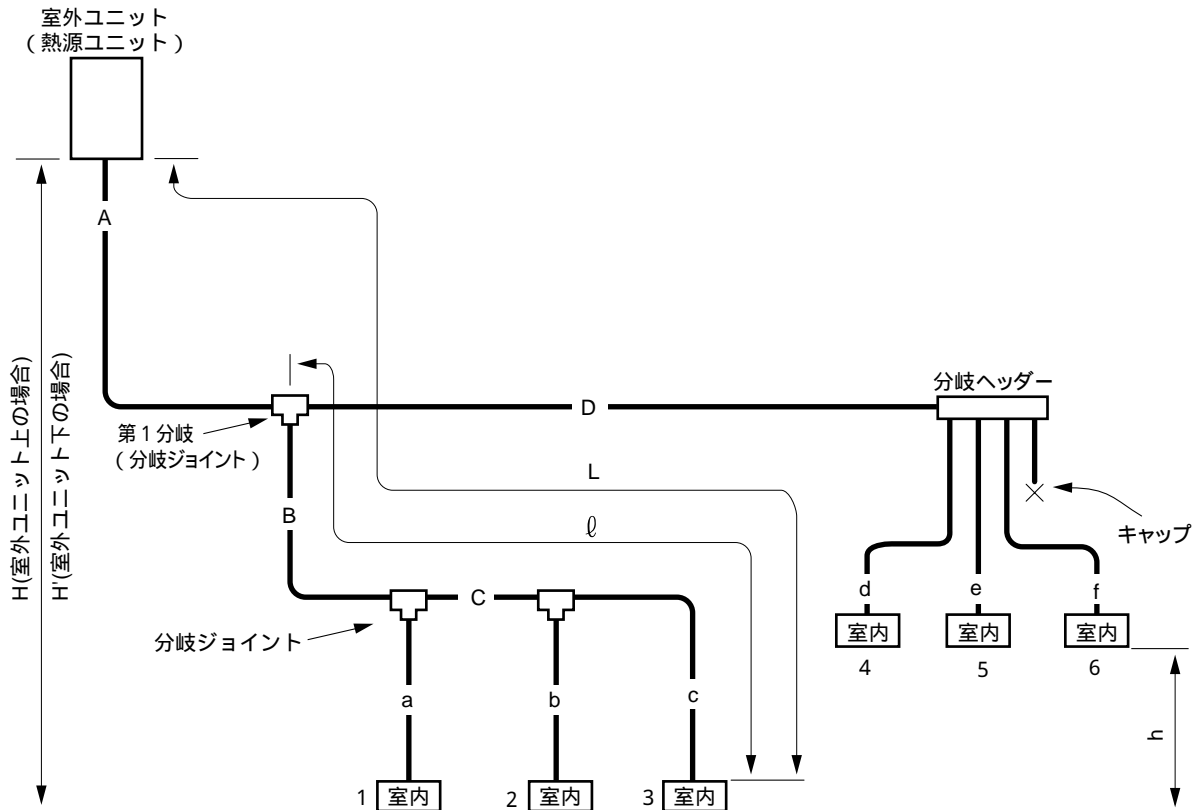

項目		配管部位	許容値	
配管長	配管総延長	$A+B+C+D+a+b+c+d+e+f$	300m以下 1	
	最遠配管長(L)	$A+B+C+c$ 又は $A+D+f$	150m以下 (相当長175m以下)	
	第1分岐以降の最遠配管長(ℓ)	$B+C+c$ 又は $D+f$	40m以下	
高低差	室内 - 室外間	室外上	H	50m以下
		室外下	H'	40m以下
差	室内 - 室内間	h	15m以下	

1 総冷媒量による規制がありますので、「-3冷媒配管工事」を参照下さい。

P784 ~ P900形

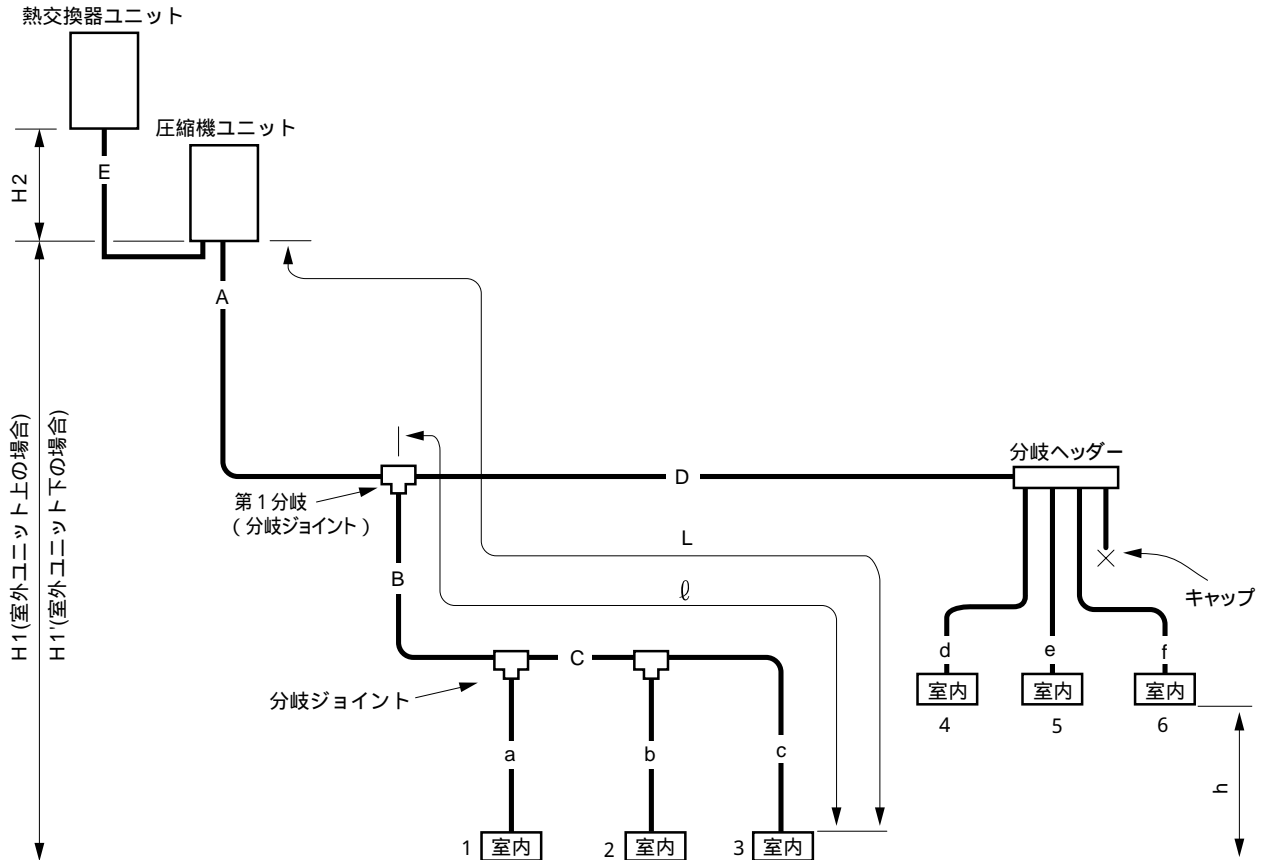

		項目	配管部位	許容値
配管長	室内側	配管総延長	$A+B+C+D+E+F+a+b+c+d+e+f$	300m以下
		最遠配管長さ ( L )	$A ( B )+C+D+E+c$	150m以下 ( 相当長175m以下 )
		第1分岐以降の最遠配管長 ( $\ell$ )	$D+E+c$	40m以下
	室外側	圧縮機ユニット - 熱交換器ユニット間	E	10m以下 ( 相当長12m以下 )
高低差	室内 - 室外間	室外上	H1	50m以下
		室外下	H1	40m以下
	室内 - 室内間		h	15m以下
	圧縮機ユニット - 熱交換器ユニット間		H2	0.1m以下

P960～P1400形

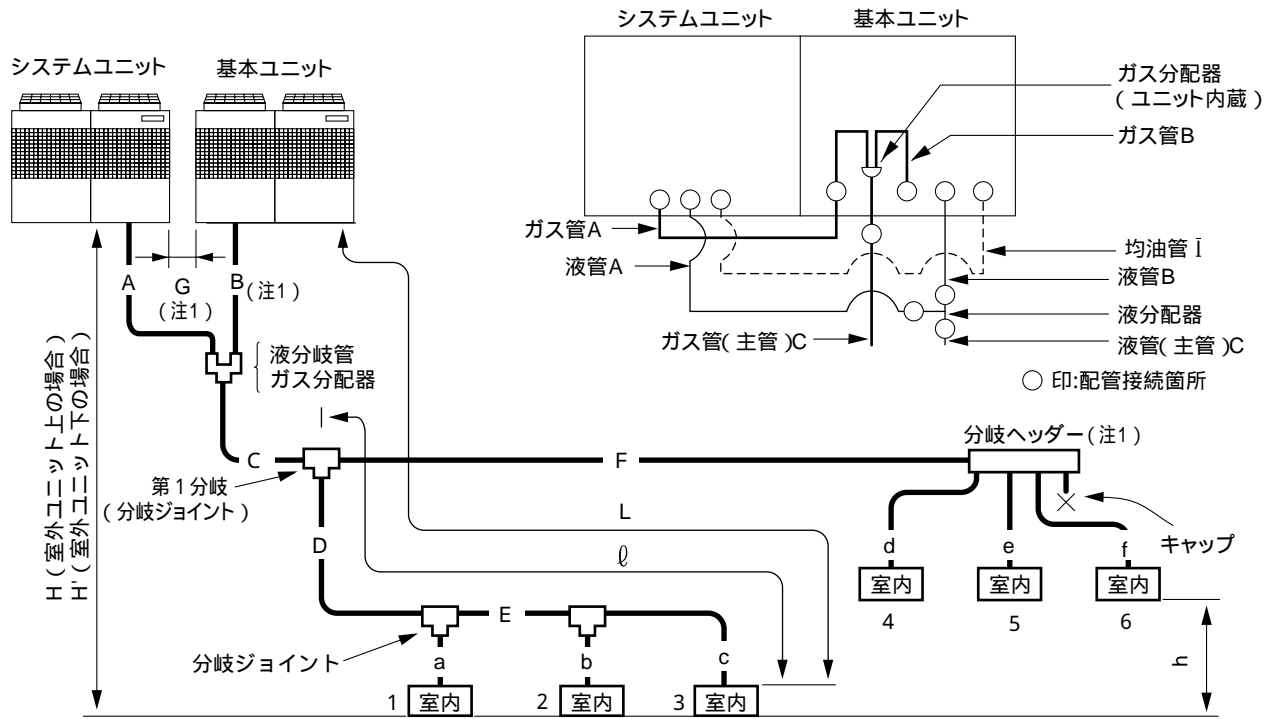

(注1) ガス分配器は、ユニットに内蔵されるためBは液管のみとなります。システムユニットと基本ユニットは、上記G寸法( G=4m以下)で設置してください。ヘッダー分岐後の再分岐配管はできません。

		項目	配管部位	許容値
配管長	室内側	配管総延長	$A+B+C+D+E+F+a+b+c+d+e+f$	300m以下
		最遠配管長さ(L)	$A(B)+C+D+E+c$	150m以下(相当長175m以下)
		第1分岐以降の最遠配管長( $l$ )	$D+E+c$	40m以下
	室外側	均油管		4m以下(相当長5m以下)
		液分岐管-システム、基本ユニット間	A, B (液管)	4m以下(相当長5m以下)
		ガス分配器-システムユニット間	A (ガス管)	4m以下(相当長5m以下)
高低差	室内-室外間	室外上	H	50m以下
		室外下	H	40m以下
	室内-室内間		h	15m以下
	システムユニット-基本ユニット間		-	0.1m以下

## 2.冷媒配管の選定

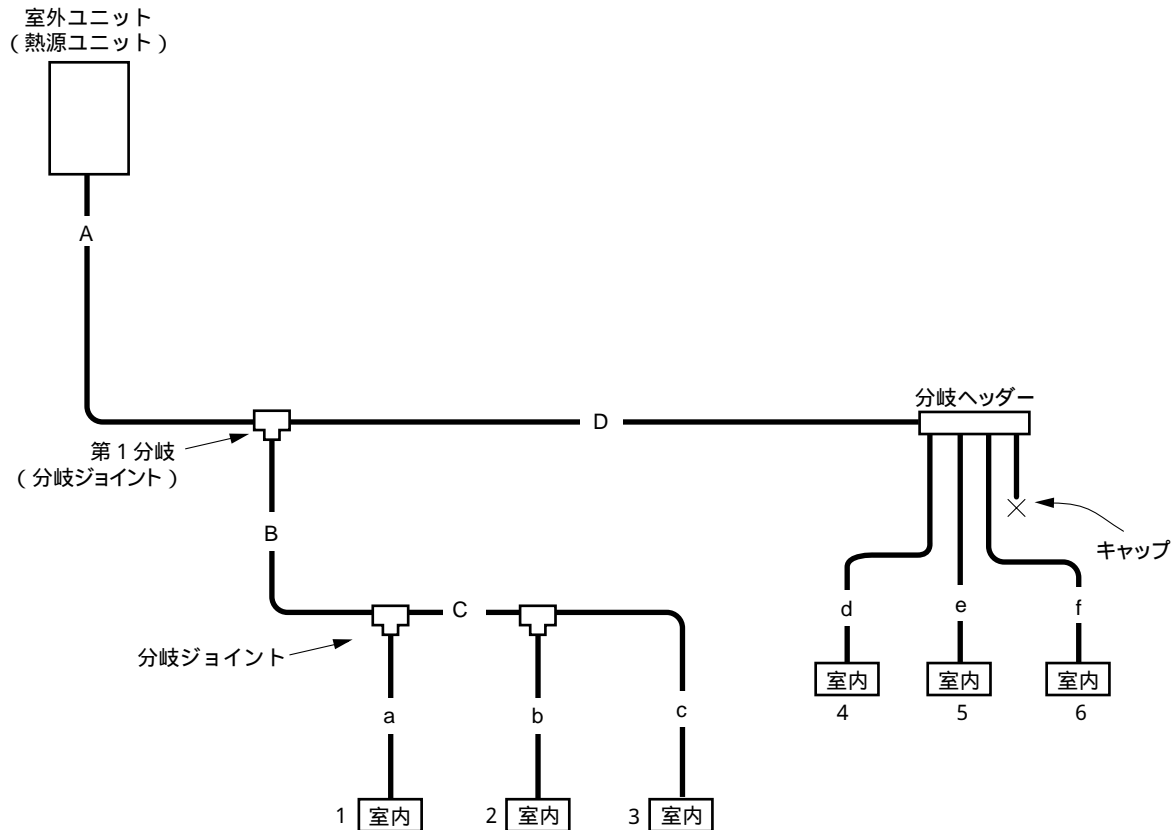

1. P500形～P730形をご使用の場合は、第1分岐部には、必ず、分岐ジョイント(CMY-Y202-D)をご使用ください。  
P784形～P900形をご使用の場合は、第1分岐部には、必ず、分岐ジョイント(CMY-Y302-D)をご使用ください。  
P960形～P1400形をご使用の場合は、第1分岐部には、必ず、分岐ジョイント(CMY-Y302-D)をご使用ください。このとき、片側の分岐下流合計は730形以下としてください。第1分岐で両方が730形以上となる場合、分岐ジョイント(CMY-Y302-D)を2個順次接続し、分岐してください。
2. ヘッダー分岐後の再分岐はできません。

### [選定手順]

1. 分岐ジョイントの選定  
分岐ジョイントは、下流側に接続される室内ユニットの合計容量より、[表1]で選定してください。
2. 分岐ヘッダーの選定  
分岐ヘッダーは、接続される室内ユニットの台数により、[表1]で選定してください。
3. 冷媒配管サイズの選定
 

室外 - 第1分岐部間 [ A 部 ]	: 室外ユニットの配管サイズと同じです。[表4]
分岐部 - 分岐部間 [ B ~ D 部 ]	: 下流側に接続される室内ユニットの合計容量より、[表2]で選定してください。
分岐部 - 室内間 [ a ~ f 部 ]	: 室内ユニットの配管サイズと同じです。[表3]

表1.分岐管キットの種類

分岐管の種類	室内ユニットの合計容量	分岐管の形名	対応室外ユニット															
			P140	P160	P224	P280	P335	P355	P400	P450	P500	P560	P630	P674	P730	P784	P840	P900
分岐ジョイント	P224以下	CMY-Y102S-D																
	P225~P450	CMY-Y102L-D																
	P451~P730	CMY-Y202-D																
	P731以上	CMY-Y302-D																
分岐ヘッダー	4分岐用	P224以下	CMY-Y104-D															
	8分岐用	P450以下	CMY-Y108-D															
	10分岐用	P730以下	CMY-Y1010-D															

表2.分岐部間の配管サイズ

下流室内ユニットの合計容量	分岐部間の配管サイズ	
	液管	ガス管
P160以下	9.52	15.88
P161~P224		19.05
P225~P335		22.2
P336~P450	12.7	25.4
P451~P730	15.88	28.58
P731~P900	19.05	31.8
P901以上		38.1

表3.室内ユニットの配管サイズ

室内ユニット容量	液管	ガス管
P22・P28・P36・P45・P56 LGH-50RDF	6.35	12.7
P71・P80・P90 LGH-80・100RDF	9.52	15.88
P112・P140・P160		19.05
P224		22.2
P280		28.58
P450	12.7	28.58
P560	15.88	28.58

表4.室外ユニットから室内ユニットへの配管サイズ(主管)

室外ユニット形名	液管	ガス管
PUHY-P140M-E	9.52	15.88
PUHY-P160M-E	9.52	19.05
PUHY-P224M-E	9.52	19.05
PUHY-P280M-E	9.52	22.2
PUHY-P335M-E	9.52	22.2
PUHY-P355M-E	12.7	25.4
PUHY-P400M-E	12.7	25.4
PUHY-P450M-E	12.7	28.58
PUHY-P500M-E	15.88	28.58
PUHY-P560M-E	15.88	28.58
PUHY-P630M-E	15.88	28.58
PUHY-P674M-E	15.88	28.58
PUHY-P730M-E	15.88	28.58
PUHY-P784SM-E	19.05	31.75
PUHY-P840SM-E	19.05	31.75
PUHY-P900SM-E	19.05	31.75
PUHY-P960~P1400SKM-E システム・基本ユニット~液・ガス分配器	15.88	28.58
液・ガス分配器~室内ユニット	19.05	38.1

表5.冷媒配管の選定

配管径・肉厚・材質に注意ください。

配管径	最小肉厚	材質
6.35	0.8	0材以上
9.52	0.8	
12.70	0.8	
15.88	1.0	
19.05	1.0	1/2HまたはH材以上
22.22	1.0	
25.40	1.0	
28.58	1.0	
31.75	1.1	
38.1	1.35	

1. 19.05では肉厚1.2tの0材をご使用ください。

表6.フレア加工(0材,0L材のみ)

R410Aのフレア加工寸法は気密性を増すために従来より大きくなります。

フレア部加工寸法は下表を参照してください。

フレア加工寸法(mm)

配管外形	呼び	A寸法
		R410A
6.35	1/4"	9.1
9.52	3/8"	13.2
12.70	1/2"	16.6
15.88	5/8"	19.7
19.05	3/4"	24.0

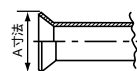

フレアナット寸法(mm)

配管外形	呼び	B寸法
		R410A(2種)
6.35	1/4"	17.0
9.52	3/8"	22.0
12.70	1/2"	26.0
15.88	5/8"	29.0
19.05	3/4"	36.0

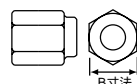



### 3.冷媒漏洩による注意事項

#### (1) はじめに

マルチエアコンをはじめほとんどのエアコンは冷媒として(HFC R407CもしくはHFCR410A)を使用しています。この冷媒自体は無毒、不燃性の安全冷媒ですが、エアコンを施設する部屋は、万一その室内に冷媒ガスが漏洩しても、冷媒ガスの濃度が限界濃度を超えない部屋の大きさおよび適切な対応が必要です。

KHK(高圧ガス保安協会)では、自主基準として冷凍空調装置の施設基準(KHK S0010)の中で冷媒ガスの限界濃度を定めています。また、(社)日本冷凍空調工業会ではマルチ形パッケージエアコンの冷媒漏洩時の安全確保のための施設ガイドライン(JRA-GL13)を定めています。

以下に、その要点についてご紹介するとともに冷媒濃度の確認手順と対応についてご説明します。

**限界濃度**

限界濃度とは、冷媒が空气中に漏洩したときに、人身に支障なく緊急処置が行えるフロンガス濃度の限界を言います。この限界濃度の単位は、計算を容易にするためにkg/m<sup>3</sup>(1m<sup>3</sup>の空气中のフロンガス質量kg)とします。

R410Aの限界濃度：0.30kg/m<sup>3</sup>

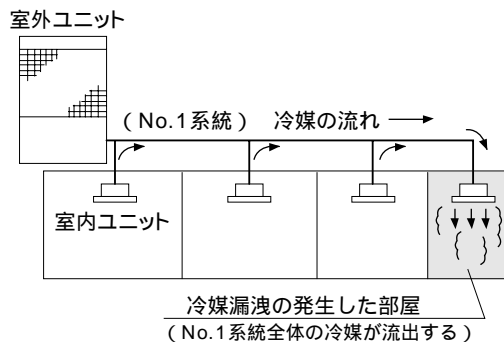

#### (2) 限界濃度確認手順

~ の手順に従って限界濃度を算出してください。

各冷媒系統毎に全冷媒充てん量(kg)を算出。

【算出方法】

(室外ユニット1系統の冷媒充てん量) + (追加冷媒充てん量) = 冷媒設備の全冷媒充てん量(kg)

工場出荷時の冷媒充てん量

現地での配管長さや配管径に応じて追加する冷媒量

注：1つの冷媒設備で、2つ以上の冷媒系統に分割され、それぞれが独立している場合は、それぞれの冷媒充てん量を採用します。

室内容積が最少の室内容積(m<sup>3</sup>)を算出。

次のような場合は、□の部分をもつ部屋、又は最小の部屋として容積を算出してください。

(a) 間仕切りのない場合

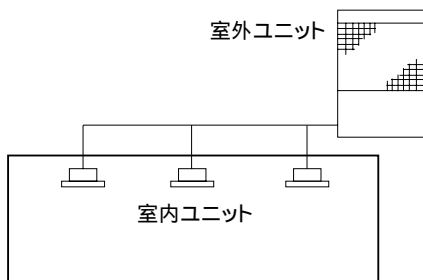

(b) 間仕切りがあるが、隣室との間に換気に有効な開口部がある場合

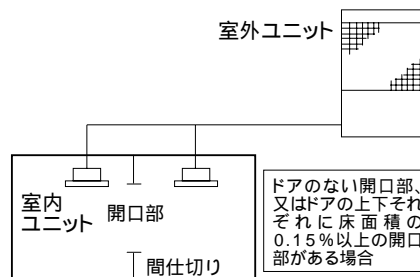

(c) 間仕切りがあって有効な開口部がない場合

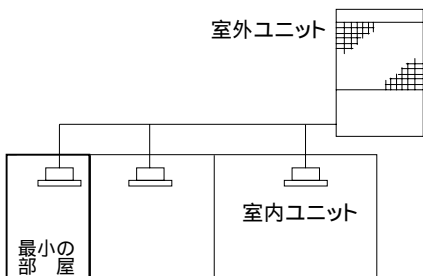

の計算結果により冷媒濃度を算出。

【算出方法】

$$\frac{\text{(冷媒設備の全冷媒充てん量 (kg))}}{\text{(室内ユニットを設置する最小室内容積 (m³))}} = \text{限界濃度 (kg/m³)}$$

計算結果が限界濃度を超過している場合は、2番目、3番目と順に室内容積の大きいものへ移行しながら同様の計算を実施し、限界濃度を超過しているすべての対象を明らかにしてください。

### (3) 限界濃度を越えた場合の対応 (JRA-GL13-1998)

室内容積に対して冷媒濃度が限界を越えた場合は以下の要領によって適切な対応を行ってください。

対応1

換気のため、開口部を設ける。

部屋の外部とつながるドアの上下分それぞれ床面積の0.15%以上の開口部を設けるか、ドアのない開口部を設けてください。

対応2

冷媒設備の全冷媒充てん量を減らす。

(1)冷媒配管長を短くする。

室外ユニットの置き場所を室内ユニットの近くに変更して、冷媒配管長を短くすることで全冷媒充てん量を低減します。

(2)室外ユニットの容量を小さくする。

室外ユニットを複数台に分散することで一冷媒系統当たりの室外ユニット容量を小さくし冷媒充てん量を低減します。

例えば 20HP × 1台のシステムは10HP × 2台のシステムにすることで、一冷媒系統当たりの冷媒量を約半分にすることができます。

対応3

換気システムの設置

換気システムを設置することにより万一冷媒が漏洩した場合の冷媒濃度の過昇を防止します。

換気システムは外気導入方式と排気方式とがありますが、冷媒の性質等から外気導入方式を推奨します。

(1)換気量

換気量は対象冷媒設備の全冷媒充てん量と部屋容積によって図1に示す量以上としてください。

(2)センサ - との連動

換気システムは原則として空調機の使用 / 不使用、室内への在 / 不在に関わらず常に作動させてください。それが不可能な場合はセンサーシステムによって冷媒漏洩時に換気システムを自動的に作動させてください。図2に常時換気システム、図3にセンサー連動システムを示します。

諸注意

(a)換気システムを設置する場合でも万一の換気システムの故障を考え、図1(18ページ)の斜線で示す範囲は選定しないようにしてください。この範囲に入る場合は原則的に、**対応1** **対応2** に示すように換気のために有効な開口部を設けて対象となる部屋の容積を大きくするかまたは、室外ユニット容量もしくは配管長の見直しを行い全冷媒量の削減を行ってください。

(b)換気システムを設置した場合で図1の斜線で示す範囲に入り、**対応1** **対応2** がとれない場合は、換気システムとは別の独立した安全確保のための手段を設けてください。具体的には冷媒漏洩時のセンサ - によって作動する冷媒遮断弁や在室者の危険を知らせる確実な警報システムの併設です。この場合センサーは上記換気システム作動用のセンサ - とは別にしてください。図4に冷媒遮断弁併設の場合を示します。

- (c)換気システムを設置する場合、部屋の最下部には必ず換気に有効な隙間（ドア下隙間など）を設けてください。
- (d)居住区間内の配管接続部については細心の注意を払い、JISに適合した確実な施工と、施工完了後の気密試験を徹底してください。また、配管は地震などの外力によって破損しないよう耐震支持を実施する（但し温度変化による応力が発生しないように軸方向には逃げを設ける）等を徹底してください。

対応3 の場合のフローチャートを図5に示します。



図2 常時換気システム（外気導入の例）



図3 センサー連動システム（外気導入の例）

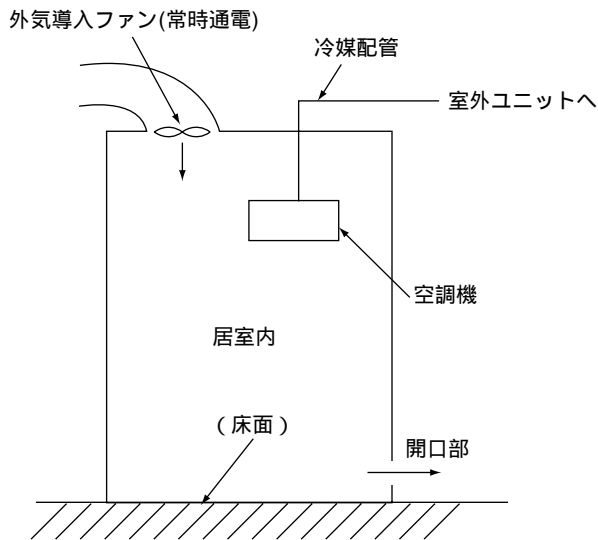

図4 常時換気システムと冷媒遮断弁の併設

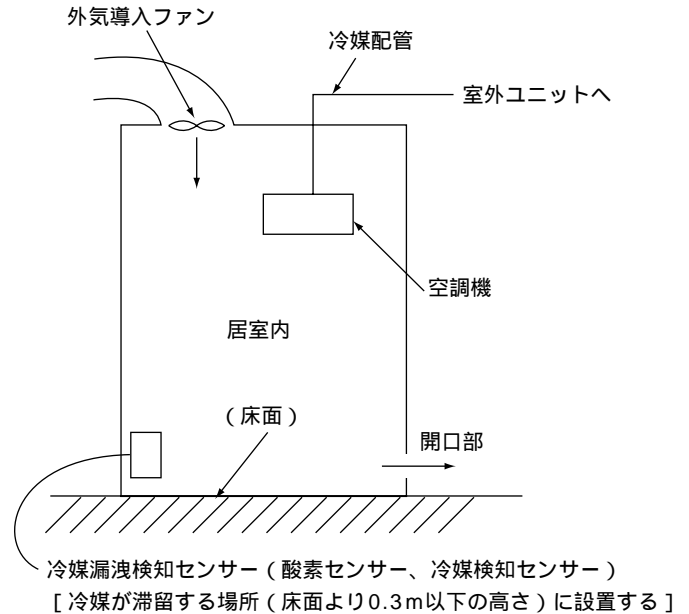

図1 換気量によるシステムの選定

表1 縦引配管の標準支持間隔

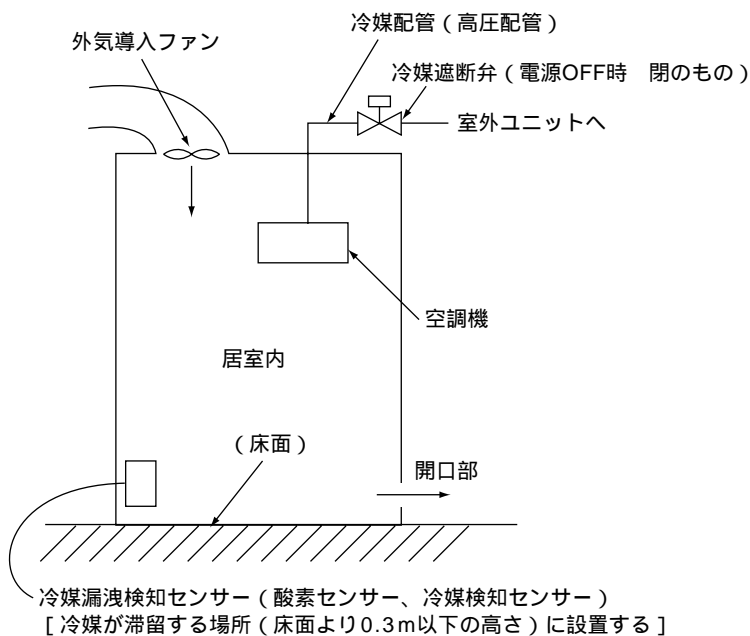
配管外径(mm)	標準支持間隔(m)
22.2以下	1.0
28.6以上～41.3以下	1.5
54.0	2.0
66.7以上～104.9以下	2.5
130.2以上	3.0

『日本建築センター「建築設備耐震設計・加工指針」による。』  
備考：横引配管等は、地震による軸直角方向の過大な変位を抑制するよう耐震支持を行うこと。

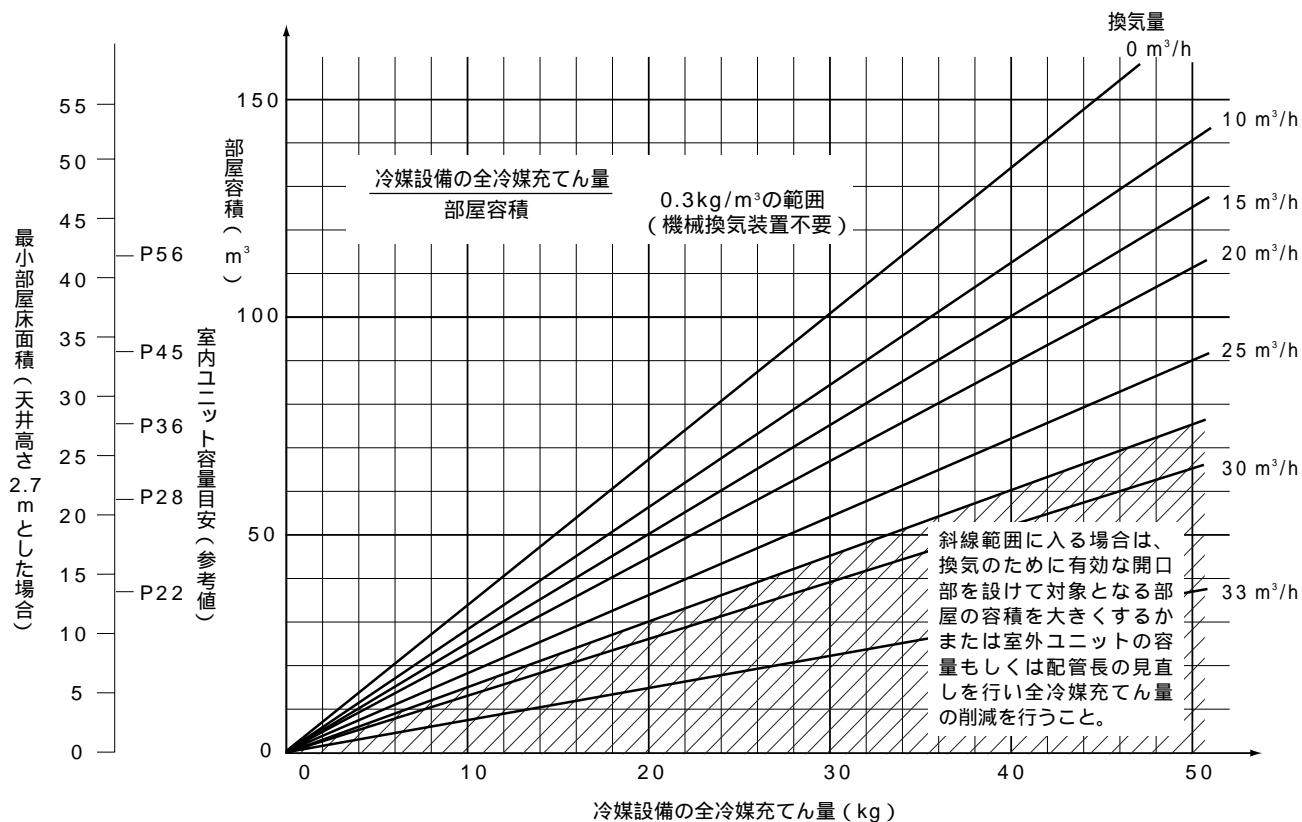
表2 縦引配管の標準支持間隔

配管外径(mm)	呼径(A)	標準支持間隔(m)
28.6	25	1.0～4.5
34.9	32	1.0～5.0
41.3	40	1.0～5.5
54.0	50	1.0～6.0
66.7	65	1.0～6.5
79.4	80	1.0～7.0
〃	90	1.0～8.0
104.8	100	1.0～8.5
130.2	125	1.5～9.0
155.6	150	1.5～10.0
〃	200	2.0～11.5
〃	250	2.5～13.0
〃	300	2.5～14.0

『日本建築センター「建築設備耐震設計・加工指針」による。』  
備考：縦引配管等は、地震による軸直角方向の過大な変位を抑制するよう耐震支持を行うこと。



図5 冷媒漏洩対応フローチャート

# 据付スペース

## 1. 据付場所の選定

室外ユニットは、下記条件を考慮して据付場所を選定してください。

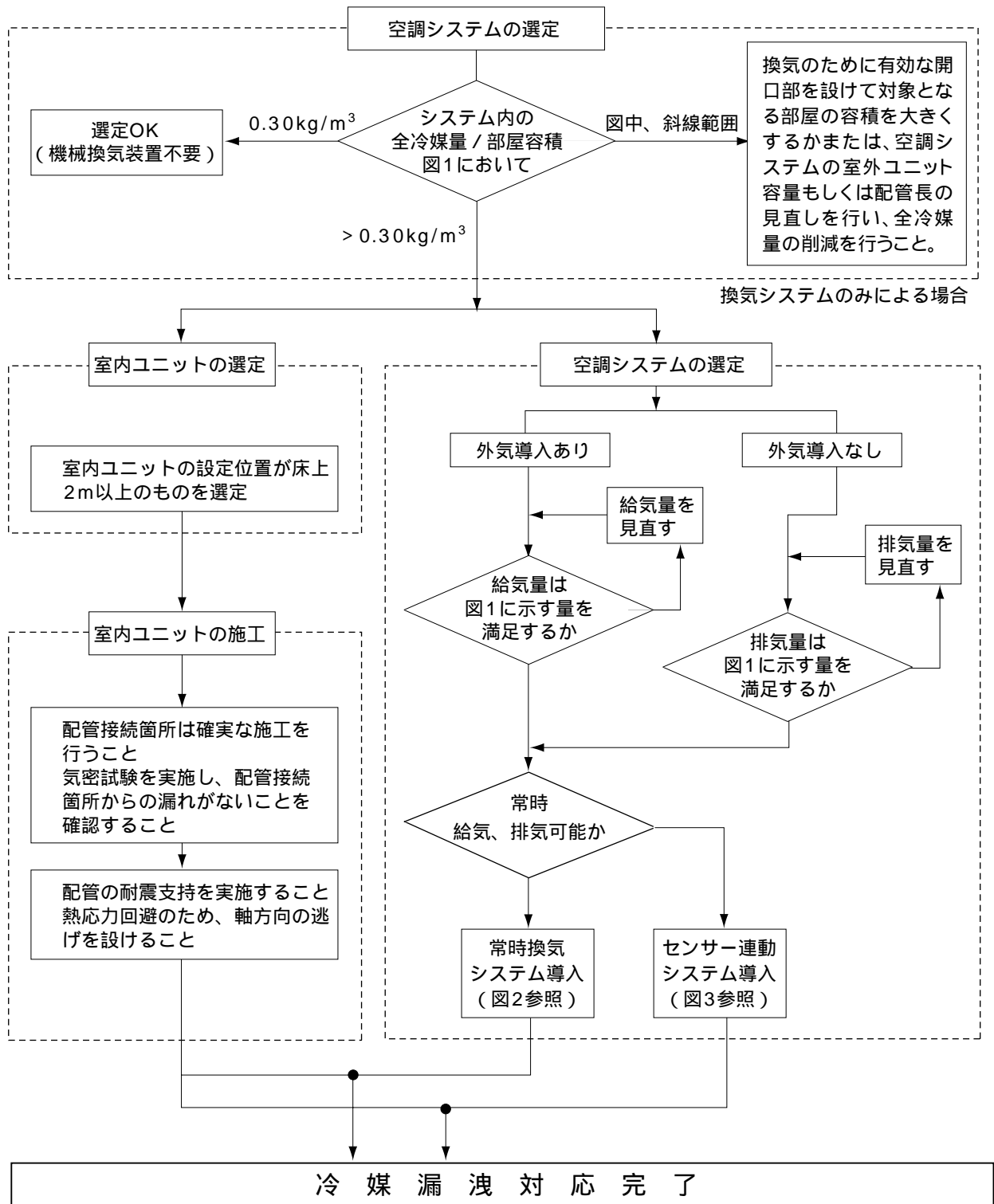
他の熱源から直接ふく射熱を受けないところ。

ユニットから発生する騒音が隣家に迷惑のかからないところ。

強風が吹きつけないところ。

本体の質量に十分耐えられる強度のあるところ。

暖房運転時には、ユニットからドレンが流れますのでご注意ください。

次項「2. 据付スペース」に示すサービス、風路スペースがあるところ。

可燃性ガスの発生、流入、滞留、漏れのおそれがある場所では、火災をおこす危険性がありますので設置しないでください。

酸性の溶液や特殊なスプレー（イオウ系）を頻繁に使用する場所は避けてください。

油、蒸気、硫化ガスの多い特殊環境では使用しないでください。

外気10 以下にて冷房運転を実施する可能性がある場合は、ユニットの安定した運転を確保するため、室外ユニットに直接雨雪が当たらない場所を選定するか、吹出ダクト、吸込ダクトを取付けるようにしてください。また、室外ユニットは室内ユニットと同一階以上の位置に設置してください。（下図参照）

### 室外ユニットの設置制限

<外気10 以下にて冷房運転する場合>

（ECOシリーズの場合）

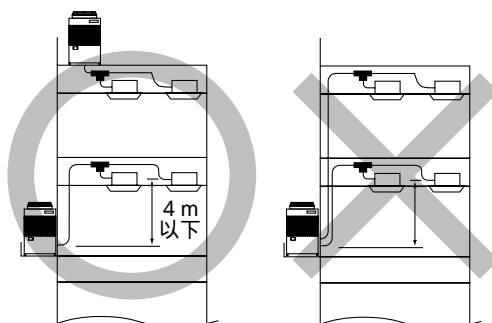

（室内ユニットと同一階以上）

## 2.据付スペース

### P140～P450形

#### 【必要空間の基本】

##### 単独設置の場合

後面側は吸込空気の関係上1000mm以上必要ですが、後面からのサービス等を考慮した場合、前面同様450mm程度開いていた方が便利です。

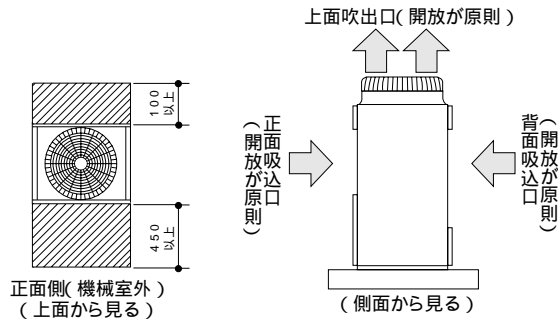

#### 【ユニットの上方に障害物がある場合】

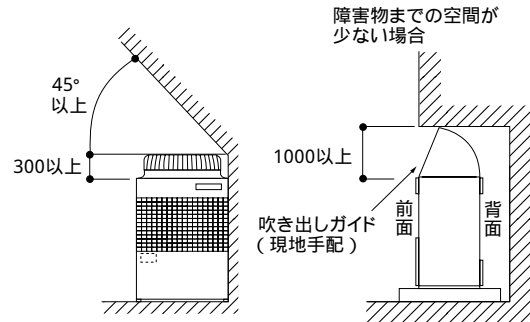

#### 【ユニット左右から吸込空気が入る場合】

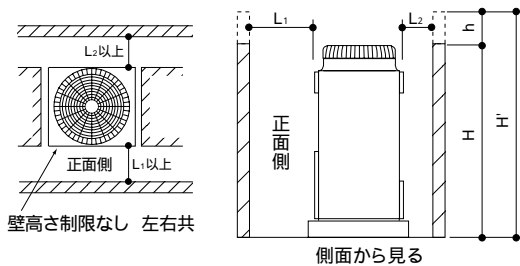

(注)・前、後の壁高さ<H>は、ユニットの全高以下のこと。  
・前、後の壁高さ<H'>がユニットの全高を超える場合は、上図のh寸法を右表のL<sub>1</sub>、L<sub>2</sub>に加算してください。

$h = \text{壁高さ} < H' > - \text{ユニット全高}$

L <sub>1</sub>	L <sub>2</sub>
450	100

#### 【ユニット周囲が壁の場合】

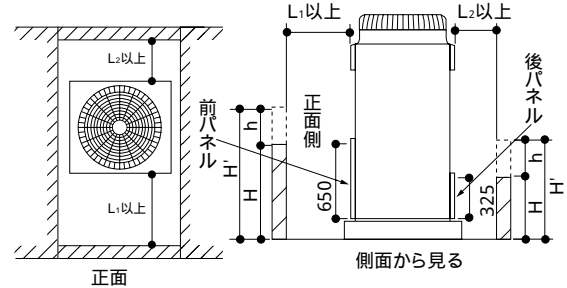

(注)・前、後の壁高さ<H>はユニットの前、後パネルの高さ以下のこと。  
・前、後の壁高さ<H'>がパネル高さをを超える場合は、上図のh寸法を下表のL<sub>1</sub>、L<sub>2</sub>に加算してください。

$h = \text{壁高さ} < H' > - \text{パネル高さ}$

例 h = 100の場合

L<sub>1</sub>寸法は450 + 100 = 550

となります。

L <sub>1</sub>	L <sub>2</sub>
450	100

#### 集中設置・連続設置の場合

多数のユニットを設置する場合は、人の通路、風の流通を考慮して、各ブロック間に下図スペースをとってください。  
(単位 mm)

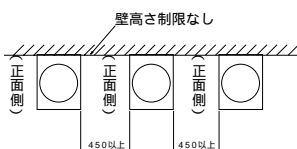
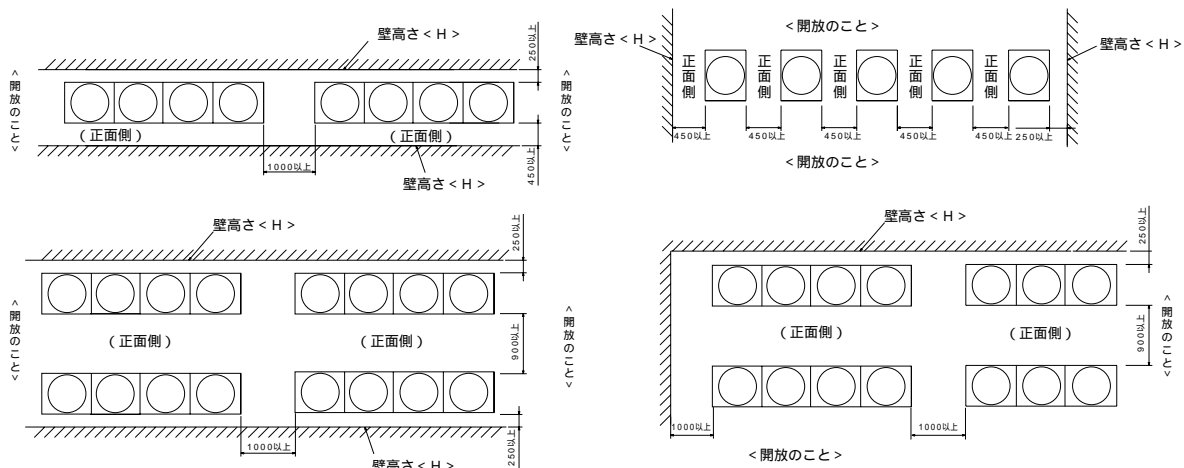

- 2方向は開放としてください。
- 壁高さ H がユニットの全高を超える場合は 印の寸法にh寸法 (h = 壁高さ H - ユニット全高)を加えてください。
- ユニット前後に壁がある場合は、側面方向への連続設置は最大4台とし、4台毎に吸込スペース兼通路スペースとして、1000mm以上をとってください。

# P500 ~ P730形

## 【必要空間の基本】

### 単独設置の場合

後面側は吸込空気の関係上100mm以上必要ですが、後面からのサービス等を考慮した場合、前面同様450mm程度開いていた方が便利です。

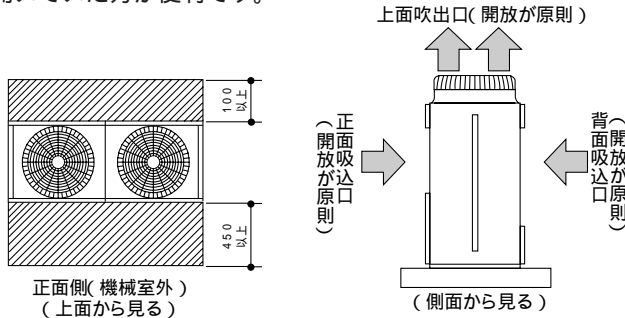

### 【ユニットの上方に障害物がある場合】

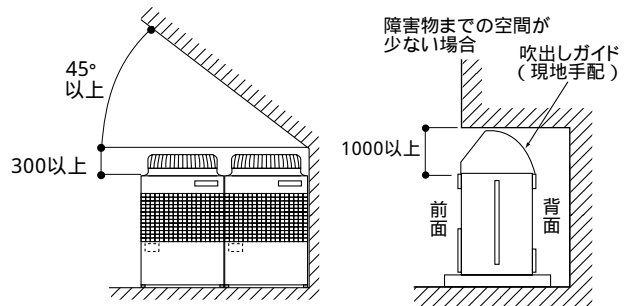

### 【ユニット左右から吸込空気が入る場合】

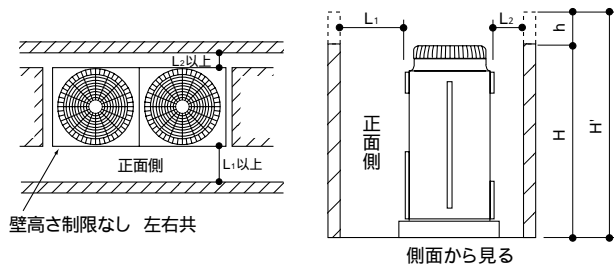

### 【ユニット周囲が壁の場合】

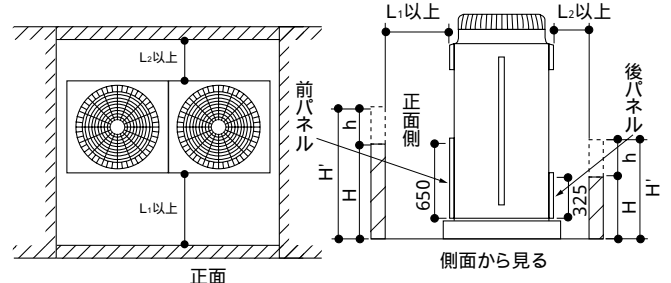

- (注) ・前、後の壁高さ < H' > は、ユニットの全高以下のこと。  
 ・前、後の壁高さ < H' > がユニットの全高を超える場合は、上図の h 寸法を右表の L<sub>1</sub>、L<sub>2</sub> に加算してください。

- (注) ・前、後の壁高さ < H' > はユニットの前、後パネルの高さ以下のこと。  
 ・前、後の壁高さ < H' > がパネル高さを超える場合は、上図の h 寸法を下表の L<sub>1</sub>、L<sub>2</sub> に加算してください。

h = 壁高さ < H' > - ユニット全高

L <sub>1</sub>	L <sub>2</sub>
450	100

h = 壁高さ < H' > - パネル高さ

例 h = 100の場合

L<sub>1</sub>寸法は450 + 100 = 550

となります。

L <sub>1</sub>	L <sub>2</sub>
450	100

### 集中設置・連続設置の場合

多数のユニットを設置する場合は、人の通路、風の流通を考慮して、各ブロック間に下図スペースをとってください。

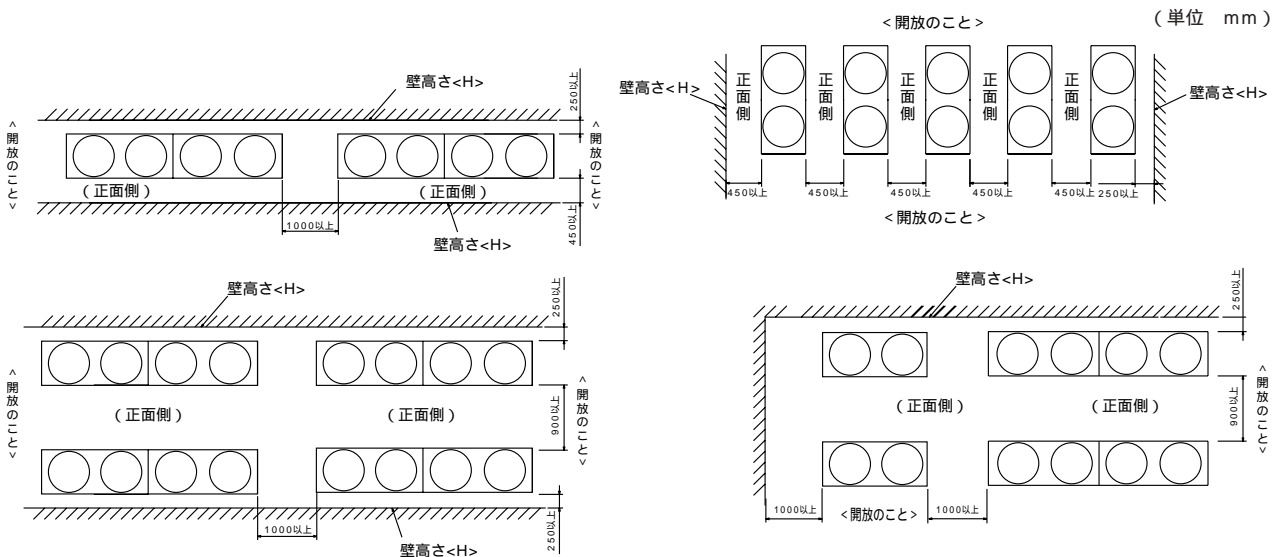

- 2方向は開放としてください。
- 壁高さ H がユニットの全高を超える場合は 印の寸法に h 寸法 (h = 壁高さ H - ユニット全高) を加えてください。
- ユニット前後に壁がある場合は、側面方向への連続設置は最大3台とし、3台毎に吸込スペース兼通路スペースとして、1000mm以上をとってください。



## P784～P900形

### 【必要空間の基本】

#### 単独設置の場合

後面側は吸込空気の関係上100mm以上必要ですが、後面からのサービス等を考慮した場合、前面同様450mm程度開いていた方が便利です。

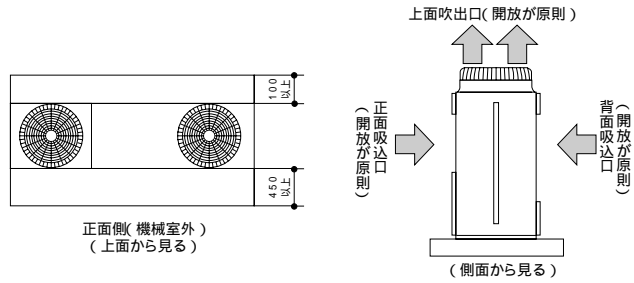

### 【ユニット左右から吸込み空気が入る場合】

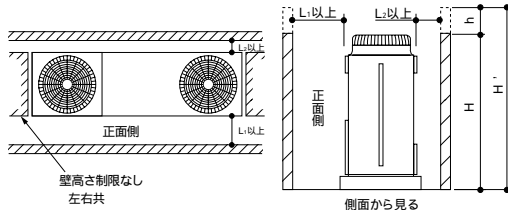

- (注) ・前、後の壁高さ <math>H</math> は、ユニットの全高以下のこと。  
 ・前、後の壁高さ <math>H'</math> がユニットの全高を超える場合は、上図の  $h$  寸法を右表の  $L_1$ 、 $L_2$  に加算してください。  
 $h = \text{壁高さ} <math>H'</math> - ユニット全高$

$L_1$	$L_2$
450	100

### 【ユニット周囲が壁の場合】

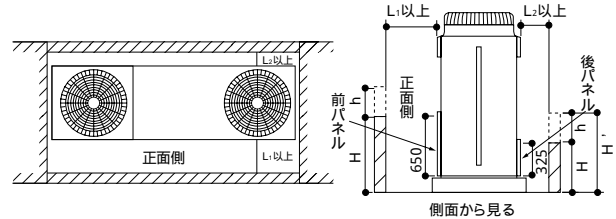

- (注) ・前、後の壁高さ <math>H</math> はユニットの前、後パネルの高さ以下のこと。  
 ・前、後の壁高さ <math>H'</math> がパネル高さを超える場合は、上図の  $h$  寸法を下表の  $L_1$ 、 $L_2$  に加算してください。

$L_1$	$L_2$
450	100

$h = \text{壁高さ} <math>H'</math> - パネル高さ  
 例  $h = 100$  の場合  
 $L_1$  寸法は  $450 + 100 = 550$  となります。$

### 【ユニットの上方に障害物がある場合】

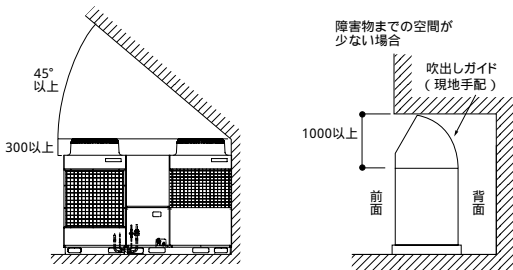

### 集中設置・連続設置の場合

多数のユニットを設置する場合は、人の通路、風の流通を考慮して、各ブロック間に下図スペースをとってください。

(単位 mm)

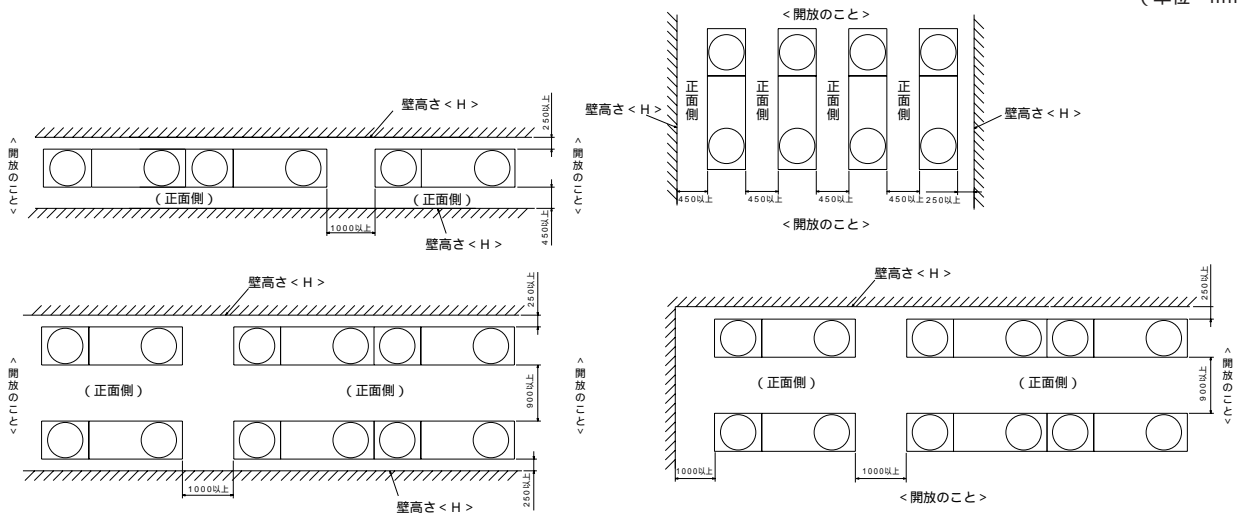

- 2方向は開放としてください。
- 壁高さ  $H$  がユニットの全高を超える場合は 印の寸法に  $h$  寸法 ( $h = \text{壁高さ} H - \text{ユニット全高}$ ) を加えてください。
- ユニット前後に壁がある場合は、側面方向への連続設置は最大2セット(圧縮機ユニットおよび熱交換器ユニット各2台)とし、2セット毎に吸込みスペース兼通路スペースとして、1000mm以上をとってください。

## P960 ~ P1400形

### 【必要空間の基本】

#### 単独設置の場合

後面側は吸込空気の関係上100mm以上必要ですが、後面からのサービス等を考慮した場合、前面同様450mm程度開いていた方が便利です。

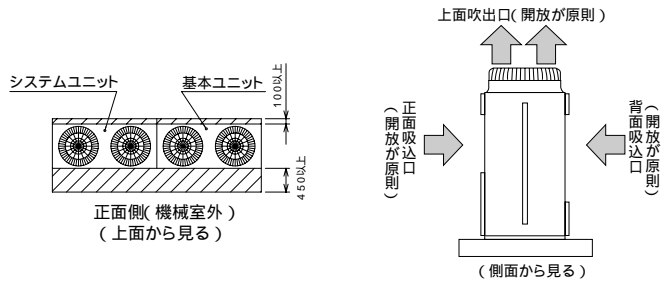

### 【ユニット左右から吸込み空気が入る場合】

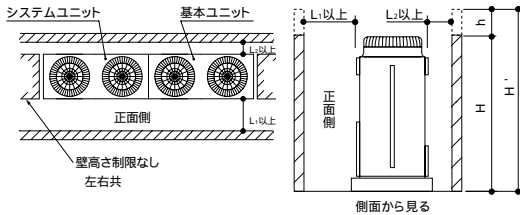

- (注) ・前、後の壁高さ <H> は、ユニットの全高以下のこと。  
 ・前、後の壁高さ <H'> がユニットの全高を超える場合は、上図のh寸法を右表のL<sub>1</sub>、L<sub>2</sub>に加算してください。  
 $h = \text{壁高さ} <H'> - \text{ユニット全高}$

L <sub>1</sub>	L <sub>2</sub>
450	100

### 【ユニット周囲が壁の場合】

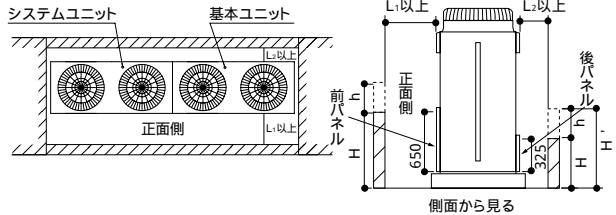

- (注) ・前、後の壁高さ <H> はユニットの前、後パネルの高さ以下のこと。  
 ・前、後の壁高さ <H'> がパネル高さを超える場合は、上図のh寸法を下表のL<sub>1</sub>、L<sub>2</sub>に加算してください。

L <sub>1</sub>	L <sub>2</sub>
450	100

$h = \text{壁高さ} <H'> - \text{パネル高さ}$   
 例  $h = 100$  の場合  
 L<sub>1</sub>寸法は  $450 + 100 = 550$  となります。

### 【ユニットの上方に障害物がある場合】

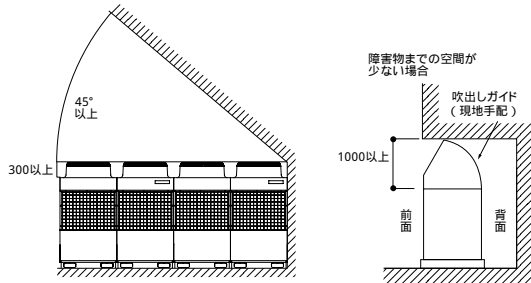

### 集中設置・連続設置の場合

多数のユニットを設置する場合は、人の通路、風の流通を考慮して、各ブロック間に下図スペースをとってください。

(単位 mm)

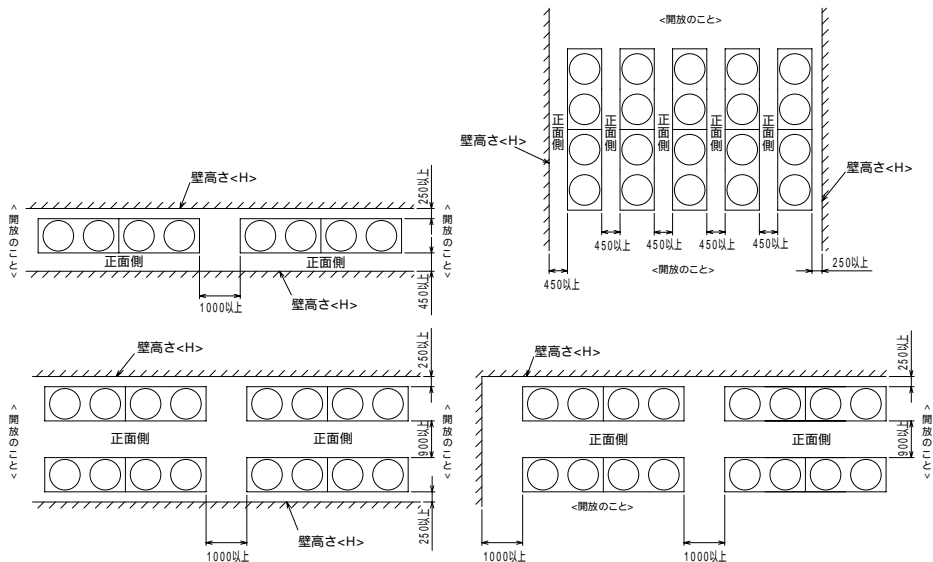

- 2方向は開放としてください。
- 壁高さ H がユニットの全高を超える場合は 印の寸法にh寸法 ( $h = \text{壁高さ} H - \text{ユニット全高}$ )を加えてください。
- ユニット前後に壁がある場合は、側面方向への設置は1セットのみ(基本ユニットおよびシステムユニット)とし、1セット毎に吸込みスペース兼通路スペースとして、1000mm以上をとってください。

# 製品仕様

## 1. 室外ユニット

### (1) 仕様表

P140～P400形

室外ユニット形名			PUHY-P140M-E	PUHY-P160M-E	PUHY-P224M-E	PUHY-P280M-E	PUHY-P335M-E	PUHY-P355M-E	PUHY-P400M-E	
電 源			三相 200V 50/60Hz							
冷房能力		kW	14.0	16.0	22.4	28.0	33.5	35.5	40.0	
暖房能力		kW	16.0	18.0	25.0	31.5	37.5	40.0	45.0	
暖房低温能力 1		kW	12.5	14.0	20.0	25.0	28.8	30.7	36.0	
電 気 特 性	消費電力	冷 房	kW	3.87	4.82	6.14	7.72	9.57	9.80	11.39
		暖 房	kW	4.06	4.75	5.98	7.62	9.10	9.74	11.02
		暖房低温 1	kW	3.96	4.88	5.92	7.15	8.26	8.80	10.65
	電 流	冷 房	A	12.40	15.45	19.68	24.75	30.69	31.42	36.52
		暖 房	A	13.01	15.23	19.17	24.43	29.18	31.23	35.34
	力 率	冷 房	%	90	90	90	90	90	90	90
		暖 房	%	90	90	90	90	90	90	90
始動電流		A	20	20	20	15	15	15	15	
熱交換器形式			クロスフィンチューブ							
圧縮機	形式 × 個数		全密閉形 × 1							
	電動機出力	kW	2.8	3.3	4.7	6.7	8.0	8.6	9.6	
	始動方式		インバーター始動							
クランクケースヒーター		W	45	45	45	45	45	45	45	
送風機	形式 × 個数		プロペラファン × 1							
	風 量	m <sup>3</sup> /min	200	200	200	200	200	200	200	
	電動機出力	kW	0.38	0.38	0.38	0.38	0.38	0.38	0.38	
法定冷凍トン		トン	1.37	1.63	2.32	3.09	3.72	3.99	4.44	
霜取方式			リバースサイクル							
保護装置	高圧保護		圧力センサー・圧力開閉器 (4.15MPa)							
	圧縮機/送風機		過電流保護・過昇保護/温度開閉器							
	インバーター回路		過電流保護・過昇保護							
冷媒配管	ガス管	mm	15.88	19.05	19.05	22.2	22.2	25.4	25.4	
	液 管	mm	9.52	9.52	9.52	9.52(注3)	9.52(注4)	12.7	12.7	
騒音値		dB[A特性]	55	56	56	57	59	60	60	
騒音値(サイレントモード)		dB[A特性]	49	49	49	49	50	50	50	
外 装 (マンセルNo)			塗装鋼板 (5Y8/1)							
外形寸法	高 さ	mm	1840	1840	1840	1840	1840	1840	1840	
	幅	mm	990	990	990	990	990	990	990	
	奥 行	mm	840	840	840	840	840	840	840	
製品質量		kg	215	215	215	230	230	230	230	
取付可能部品			圧力計・防雪フード・後配管キット・集中ドレンパン・アクティブフィルター (P140,P160,P224形を除く)							

(注1) 冷房・暖房能力は、JIS8615-1又は2の標準条件で運転した場合の最大能力です。

(注2) 1の外気温度条件は、乾球温度2、湿球温度1です。

(注3) 配線長が90m以上の場合、12.7

(注4) 配線長が40m以上の場合、12.7

P450～P730形

室外ユニット形名			PUHY-P450M-E	PUHY-P500M-E	PUHY-P560M-E	PUHY-P630M-E	PUHY-P674M-E	PUHY-P730M-E	
電 源			三相 200V 50/60Hz						
冷房能力		kW	45.0	50.0	56.0	63.0	67.4	73.0	
暖房能力		kW	50.0	56.0	63.0	67.0	75.0	81.5	
暖房低温能力 1		kW	40.0	45.0	50.0	52.4	60.0	65.0	
電 気 特 性	消費電力	冷 房	kW	13.42	13.61	15.59	17.08	17.59	19.65
		暖 房	kW	12.43	13.86	15.89	16.37	17.73	19.82
		暖房低温 1	kW	11.69	14.18	14.75	15.56	17.86	19.42
	電 流	冷 房	A	43.03	43.64	49.99	54.77	56.41	63.02
		暖 房	A	39.86	44.45	50.96	52.50	56.86	63.56
	力 率	冷 房	%	90	90	90	90	90	90
		暖 房	%	90	90	90	90	90	90
始動電流		A	15	185/171	185/171	185/171	185/171	185/171	
熱交換器形式			クロスフィンチューブ						
圧縮機	形式 × 個数		全密閉形 × 1	全密閉形 × 2					
	電動機出力	kW	9.7	6.8+5.3	8.2+5.3	9.3+5.3	10.1+5.3	10.9+5.3	
	始動方式		インバーター始動						
クランクケースヒーター		W	45	45+45	45+45	45+45	45+45	45+45	
送風機	形式 × 個数		プロペラファン × 1	プロペラファン × 2					
	風 量	m <sup>3</sup> /min	240	400					
	電動機出力	kW	0.64	0.38 × 2					
法定冷凍トン		トン	4.48	5.31/5.68	5.98/6.35	6.47/6.84	6.83/7.20	7.19/7.56	
霜取方式			リバースサイクル						
保護装置	高圧保護		圧力センサー・圧力開閉器 (4.15MPa)						
	圧縮機/送風機		過電流保護・過昇保護/温度開閉器						
	インバーター回路		過電流保護・過昇保護						
冷媒配管	ガス管	mm	28.58	28.58	28.58	28.58	28.58	28.58	
	液 管	mm	12.7	15.88	15.88	15.88	15.88	15.88	
騒音値		dB[A特性]	61	60/61	60/61	61/62	61/62	62/62.5	
騒音値 (ナイトモード)		dB[A特性]	53	53			53		
外 装 (マンセルNo)			塗装鋼板 (5Y8/1)						
外形寸法	高 さ	mm	1840	1840	1840	1840	1840	1840	
	幅	mm	1290	1990	1990	1990	1990	1990	
	奥 行	mm	840	840	840	840	840	840	
製品質量		kg	270	420	420	450	450	450	
取付可能部品			圧力計・防雪フード・後配管キット (P450のみ)・集中ドレンパン・アクティブフィルター						

(注1) 冷房・暖房能力は、JIS8615-1又は2の標準条件で運転した場合の最大能力です。

(注2) 1の外気温度条件は、乾球温度2、湿球温度1 です。

P784～P900形

セット形名	PUHY-P784SM-E		PUHY-P840SM-E		PUHY-P900SM-E		
電 源	三相 200V 50 / 60Hz						
	冷房	暖房	冷房	暖房	冷房	暖房	
能 力 (kW)	78.4	88.0	84.0	94.5	90.0	100.0	
低温暖房能力(kW) 1	-	70.0	-	75.0	-	80.0	
電 気 特 性	定格消費電力 (kW)	21.70	21.83	24.90	25.37	26.75	26.90
	低温消費電力 (kW)	-	22.06	-	25.63	-	27.18
	運転電流 (A)	69.59	70.01	79.86	81.36	85.79	86.27
	力率 (%)	90	90	90	90	90	90
	始動電流 (A)	30		30		30	

構成ユニット形名	PUHY-P684SM-E	PVHN-P100SM-E	PUHY-P740SM-E	PVHN-P100SM-E	PUHY-P800SM-E	PVHN-P100SM-E	
熱交換器形式	クロスフィンチューブ						
圧縮機	形式×個数	全密閉形圧縮機×2	-	全密閉形圧縮機×2	-	全密閉形圧縮機×2	-
	始動方式	インバーター始動	-	インバーター始動	-	インバーター始動	-
	電動機出力 (kW)	8.6+8.6	-	9.4+9.4	-	10.1+10.1	-
クランクケースヒーター (kW)	0.045+0.045	-	0.045+0.045	-	0.045+0.045	-	
送風機	形式×個数	プロペラファン×1	プロペラファン×1	プロペラファン×1	プロペラファン×1	プロペラファン×1	プロペラファン×1
	風量 (m <sup>3</sup> /min)	240	240	240	240	240	240
	電動機出力 (kW)	0.64	0.64	0.64	0.64	0.64	0.64
法定冷凍トン (トン)	3.99 + 3.99		4.35 + 4.35		4.67 + 4.67		
霜取方法	リバースサイクル						
保護装置	高圧保護	圧力センサー、圧力開閉器					
	圧縮機 / 送風機	過電流保護・過昇保護 / 温度開閉					
	インバーター回路	過電流保護・過昇保護					
冷媒配管寸法 (mm)	ガス側 (主管)	31.75口ウ付		31.75口ウ付		31.75口ウ付	
	ガス側 (圧縮機ユニット・熱交換器ユニット接続配管)	28.58口ウ付		28.58口ウ付		28.58口ウ付	
	液側 (主管)	19.05フレア		19.05フレア		19.05フレア	
	液側 (圧縮機ユニット・熱交換器ユニット接続配管)	12.7フレア		12.7フレア		12.7フレア	
騒音値 dB(A特性)	セット	62		63		64	
	構成ユニット	60.5	57	62	57	63	57
外装 (マンセルNo.)	塗装鋼板 マンセル 5Y8 / 1						
外形寸法 (mm)	高さ (H)	1840	1840	1840	1840	1840	1840
	幅 (W)	1690	990	1690	990	1690	990
	奥行 (D)	840	840	840	840	840	840
製品質量 (kg)	430	150	430	150	430	150	
取付可能部品	圧力計・防雪フード・集中ドレンパン・アクティブフィルター						

(注1) 冷房・暖房能力は、JIS8615-1又は2の条件で冷媒配管長10mで運転した場合の最大能力です。  
(注2) 1の外気温度条件は、乾球温度2、湿球温度1です。50Hz/60Hz時の能力を示しています。

P960～P1080形

セット形名	PUHY-P960SKM-E		PUHY-P1010SKM-E		PUHY-P1080SKM-E		
電 源	三相 200V 50/60Hz						
	冷房	暖房	冷房	暖房	冷房	暖房	
能 力 (kW)	96.0	108.0	101.0	113.0	108.0	119.5	
低温暖房能力(kW) 1	-	85.0	-	89.0	-	94.0	
電 気 特 性	定格消費電力 (kW)	25.28	27.47	26.71	29.10	29.23	30.42
	低温消費電力 (kW)	-	24.75	-	26.17	-	27.41
	運転電流 (A)	81.09	88.12	85.68	93.34	93.76	97.58
	力率 (%)	90	90	90	90	90	90
	始動電流 (A)	185/171		185/171		185/171	

構成ユニット形名	PUHY-P500SM-E	PUHY-P450KM-E	PUHY-P560SM-E	PUHY-P450KM-E	PUHY-P630SM-E	PUHY-P450KM-E
熱交換器形式	クロスフィンチューブ					
圧縮機	形式×個数	全密閉形圧縮機×2	全密閉形圧縮機×2	全密閉形圧縮機×2	全密閉形圧縮機×2	全密閉形圧縮機×2
	始動方式	インバーター+直入	インバーター+直入	インバーター+直入	インバーター+直入	インバーター+直入
	電動機出力 (kW)	9.4+5.3/8.5+5.3	8.5+5.3/8.5+5.3	10.3+5.3/9.6+5.3	8.5+5.3/8.5+5.3	11.2+5.3/10.9+5.3
クランクケースヒーター (kW)	0.045+0.045	0.045+0.045	0.045+0.045	0.045+0.045	0.045+0.045	0.045+0.045
送風機	形式×個数	プロペラファン×2	プロペラファン×2	プロペラファン×2	プロペラファン×2	プロペラファン×2
	風量 (m <sup>3</sup> /min)	400	400	400	400	400
	電動機出力 (kW)	0.38×2	0.38×2	0.38×2	0.38×2	0.38×2
法定冷凍トン (トン)	9.64/9.38		10.16/10.10		10.98/10.90	
霜取方法	リバースサイクル					
保護装置	高圧保護	圧力センサー、圧力開閉器				
	圧縮機/送風機	過電流保護・過昇保護/温度開閉				
	インバーター回路	過電流保護・過昇保護				
冷媒配管寸法 (mm)	ガス側(主管)	38.1口ウ付		38.1口ウ付		38.1口ウ付
	ガス側(システムユニット-基本ユニット接続配管)	28.58口ウ付		28.58口ウ付		28.58口ウ付
	液側(主管)	19.05口ウ付		19.05口ウ付		19.05口ウ付
	液側(システムユニット-基本ユニット接続配管)	15.88フレア		15.88フレア		15.88フレア
	均油管(システムユニット-基本ユニット接続配管)	9.52フレア		9.52フレア		9.52フレア
騒音値dB [A特性]	63/64		63/64		63/64	
外装(マンセルNo.)	塗装鋼板 マンセル 5Y8/1					
外形寸法 (mm)	高さ(H)	1840	1840	1840	1840	1840
	幅(W)	1990	1990	1990	1990	1990
	奥行(D)	840	840	840	840	840
製品質量(kg)	458	460	458	460	458	460
取付可能部品	圧力計・防雪フード・集中ドレンパン・アクティブフィルター					

(注1) 冷房・暖房能力は、JIS8615-1又は2の条件で冷媒配管長10mで運転した場合の最大能力です。  
(注2) 1の外気温度条件は、乾球温度2、湿球温度1です。50Hz/60Hz時の能力を示しています。

P1130～P1240形

セット形名	PUHY-P1130SKM-E		PUHY-P1180SKM-E		PUHY-P1240SKM-E		
電 源	三相 200V 50/60Hz						
	冷房	暖房	冷房	暖房	冷房	暖房	
能 力 (kW)	113.0	127.0	118.0	132.0	124.0	140.0	
低温暖房能力(kW) 1	-	100.0	-	104.0	-	110.2	
電 気 特 性	定格消費電力 (kW)	31.11	32.68	33.48	34.24	36.39	36.93
	低温消費電力 (kW)	-	29.38	-	30.79	-	33.18
	運転電流 (A)	99.79	104.83	107.39	109.83	116.73	118.46
	力率 (%)	90	90	90	90	90	90
	始動電流 (A)	185 / 171		185 / 171		185 / 171	

構成ユニット形名	PUHY-P670SM-E	PUHY-P450KM-E	PUHY-P730SM-E	PUHY-P450KM-E	PUHY-P500SM-E	PUHY-P730KM-E
熱交換器形式	クロスフィンチューブ					
圧縮機	形式×個数	全密閉形圧縮機×2	全密閉形圧縮機×2	全密閉形圧縮機×2	全密閉形圧縮機×2	全密閉形圧縮機×2
	始動方式	インバーター+直入	インバーター+直入	インバーター+直入	インバーター+直入	インバーター+直入
	電動機出力 (kW)	11.6+5.3/11.6+5.3	8.5+5.3/8.5+5.3	11.6+5.3/11.6+5.3	8.5+5.3/8.5+5.3	9.4+5.3/8.5+5.3
クランクケースヒーター (kW)	0.045+0.045	0.045+0.045	0.045+0.045	0.045+0.045	0.045+0.045	0.045+0.045
送風機	形式×個数	プロペラファン×2	プロペラファン×2	プロペラファン×2	プロペラファン×2	プロペラファン×2
	風量 (m <sup>3</sup> /min)	400	400	400	400	400
	電動機出力 (kW)	0.38×2	0.38×2	0.38×2	0.38×2	0.38×2
法定冷凍トン (トン)	11.60 / 11.44		12.24 / 12.26		13.04 / 12.98	
霜取方法	リバースサイクル					
保護装置	高圧保護	圧力センサー、圧力開閉器				
	圧縮機/送風機	過電流保護・過昇保護/温度開閉				
	インバーター回路	過電流保護・過昇保護				
冷媒配管寸法 (mm)	ガス側(主管)	38.1口ウ付		38.1口ウ付		38.1口ウ付
	ガス側(システムユニット -基本ユニット接続配管)	28.58口ウ付		28.58口ウ付		28.58口ウ付
	液側(主管)	19.05口ウ付		19.05口ウ付		19.05口ウ付
	液側(システムユニット -基本ユニット接続配管)	15.88フレア		15.88フレア		15.88フレア
	均油管(システムユニット -基本ユニット接続配管)	9.52フレア		9.52フレア		9.52フレア
騒音値dB [A特性]	63 / 64		63.5 / 64.5		64 / 65	
外装 (マンセルNo.)	塗装鋼板 マンセル 5Y8 / 1					
外形寸法 (mm)	高さ (H)	1840	1840	1840	1840	1840
	幅 (W)	1990	1990	1990	1990	1990
	奥行 (D)	840	840	840	840	840
製品質量 (kg)	458	460	458	460	458	460
取付可能部品	圧力計・防雪フード・集中ドレンパン・アクティブフィルター					

(注1) 冷房・暖房能力は、JIS8615-1又は2の条件で冷媒配管長10mで運転した場合の最大能力です。  
(注2) 1の外気温度条件は、乾球温度2、湿球温度1です。50Hz/60Hz時の能力を示しています。

P1300～P1400形

セット形名	PUHY-P1300SKM-E		PUHY-P1360SKM-E		PUHY-P1400SKM-E		
電 源	三相 200V 50/60Hz						
	冷房	暖房	冷房	暖房	冷房	暖房	
能 力 (kW)	130.0	145.0	136.0	150.0	140.0	156.5	
低温暖房能力(kW) 1	-	114.0	-	118.0	-	123.0	
電 気 特 性	定格消費電力 (kW)	39.96	38.46	44.40	39.73	47.56	42.63
	低温消費電力 (kW)	-	34.59	-	35.73	-	38.43
	運転電流 (A)	128.18	123.37	142.42	127.44	152.55	136.74
	力率 (%)	90	90	90	90	90	90
	始動電流 (A)	185 / 171		185 / 171		185 / 171	

構成ユニット形名	PUHY-P560SM-E	PUHY-P730KM-E	PUHY-P630SM-E	PUHY-P730KM-E	PUHY-P670SM-E	PUHY-P730KM-E
熱交換器形式	クロスフィンチューブ					
圧縮機	形式×個数	全密閉形圧縮機×2	全密閉形圧縮機×2	全密閉形圧縮機×2	全密閉形圧縮機×2	全密閉形圧縮機×2
	始動方式	インバーター+直入	インバーター+直入	インバーター+直入	インバーター+直入	インバーター+直入
	電動機出力 (kW)	10.3+5.3/9.6+5.3	11.6+5.3/11.6+5.3	11.2+5.3/10.9+5.3	11.6+5.3/11.6+5.3	11.6+5.3/11.6+5.3
クランクケースヒーター (kW)	0.045+0.045	0.045+0.045	0.045+0.045	0.045+0.045	0.045+0.045	0.045+0.045
送風機	形式×個数	プロペラファン×2	プロペラファン×2	プロペラファン×2	プロペラファン×2	プロペラファン×2
	風量 (m <sup>3</sup> /min)	400	400	400	400	400
	電動機出力 (kW)	0.38×2	0.38×2	0.38×2	0.38×2	0.38×2
法定冷凍トン (トン)	13.84 / 13.96		14.74 / 15.12		15.10 / 15.84	
霜取方法	リバースサイクル					
保護装置	高圧保護	圧力センサー、圧力開閉器				
	圧縮機/送風機	過電流保護・過昇保護/温度開閉				
	インバーター回路	過電流保護・過昇保護				
冷媒配管寸法 (mm)	ガス側(主管)	38.1口ウ付		38.1口ウ付		38.1口ウ付
	ガス側(システムユニット -基本ユニット接続配管)	28.58口ウ付		28.58口ウ付		28.58口ウ付
	液側(主管)	19.05口ウ付		19.05口ウ付		19.05口ウ付
	液側(システムユニット -基本ユニット接続配管)	15.88フレア		15.88フレア		15.88フレア
	均油管(システムユニット -基本ユニット接続配管)	9.52フレア		9.52フレア		9.52フレア
騒音値dB [A特性]	64 / 65		64 / 65		65 / 65.5	
外装 (マンセルNo.)	塗装鋼板 マンセル 5Y8 / 1					
外形寸法 (mm)	高さ (H)	1840	1840	1840	1840	1840
	幅 (W)	1990	1990	1990	1990	1990
	奥行 (D)	840	840	840	840	840
製品質量 (kg)	458	460	458	460	458	460
取付可能部品	圧力計・防雪フード・集中ドレンパン・アクティブフィルター					

(注1) 冷房・暖房能力は、JIS8615-1又は2の条件で冷媒配管長10mで運転した場合の最大能力です。  
(注2) 1の外気温度条件は、乾球温度2、湿球温度1です。50Hz/60Hz時の能力を示しています。



## (2) 外形図

### PUHY-P140・P160・P224・P280・P335・P355・P400M-E

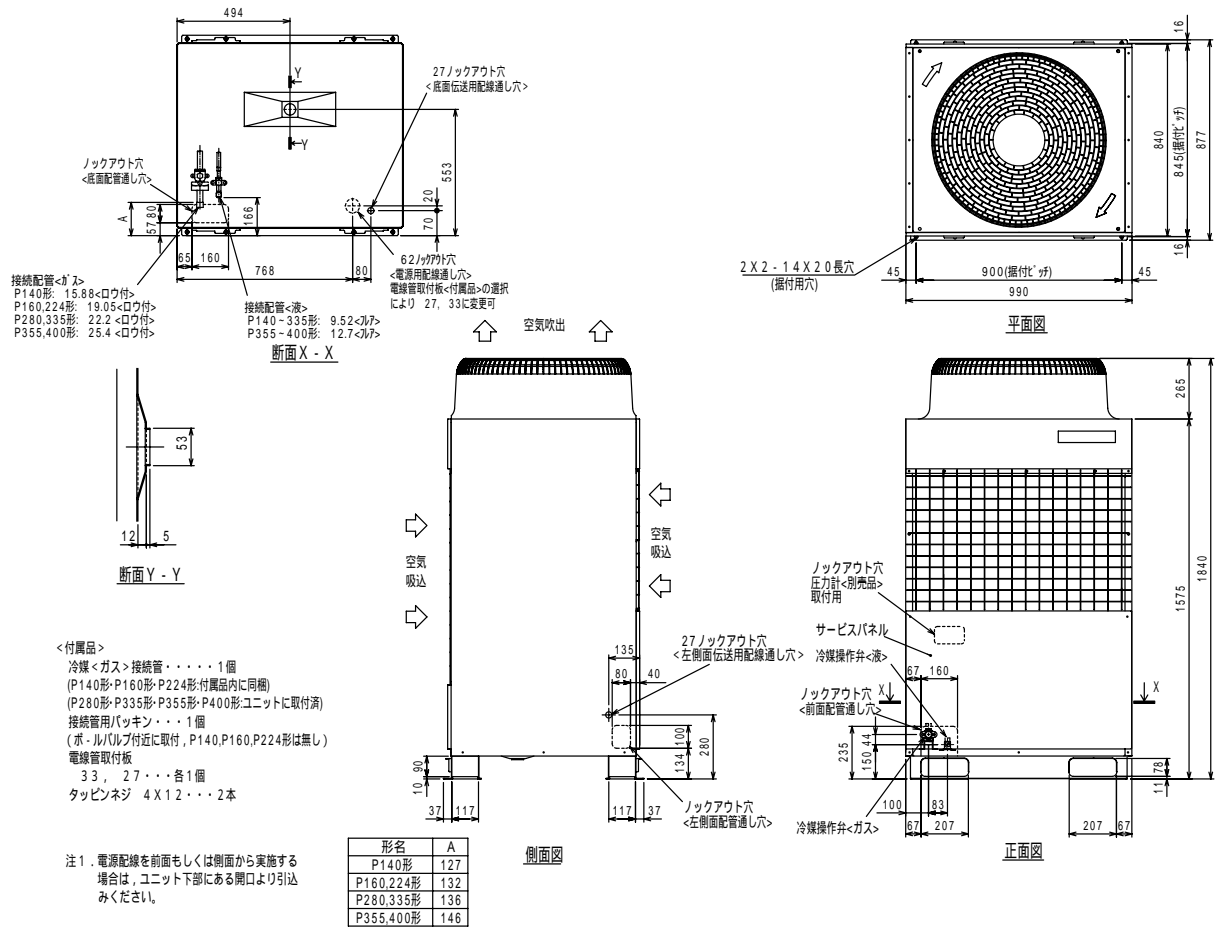

### PUHY-P450M-E

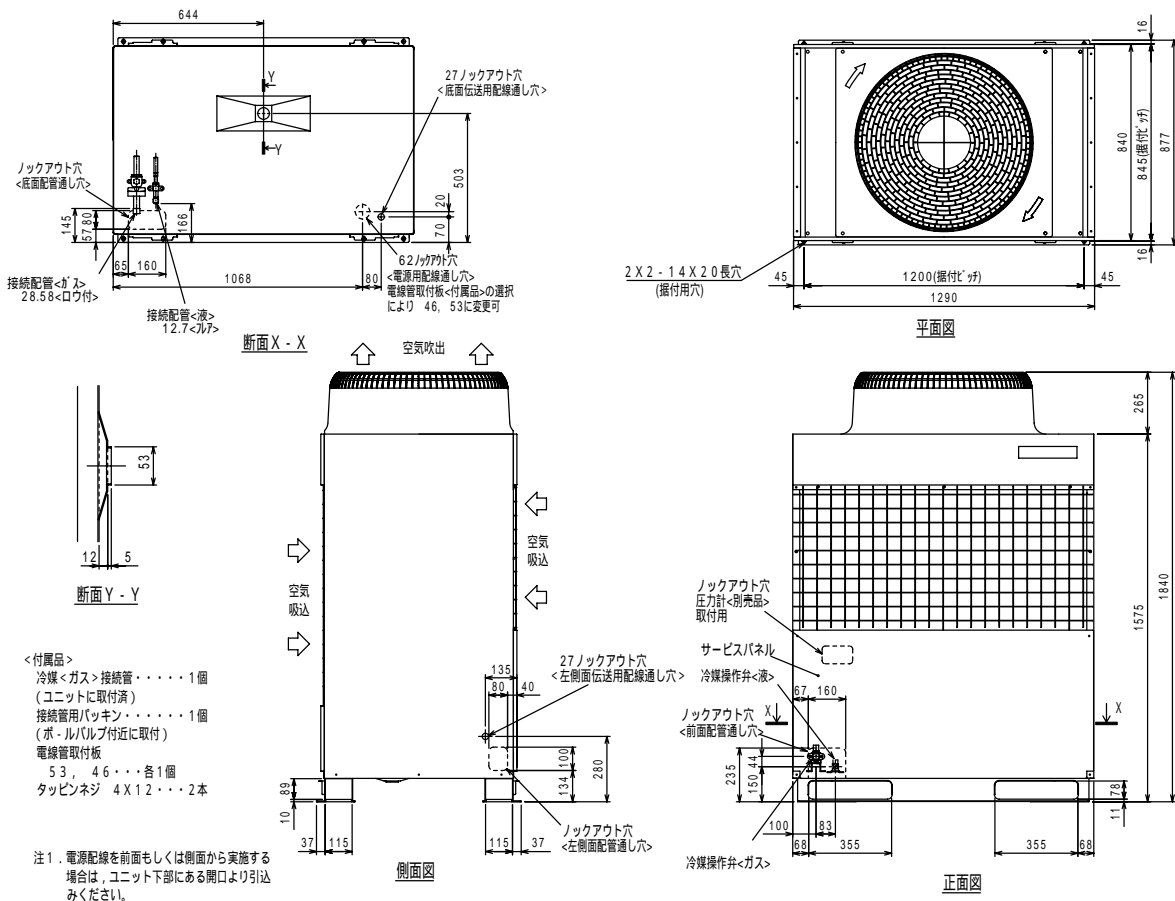

PUHY-P500・P560・P630・P674・P730形

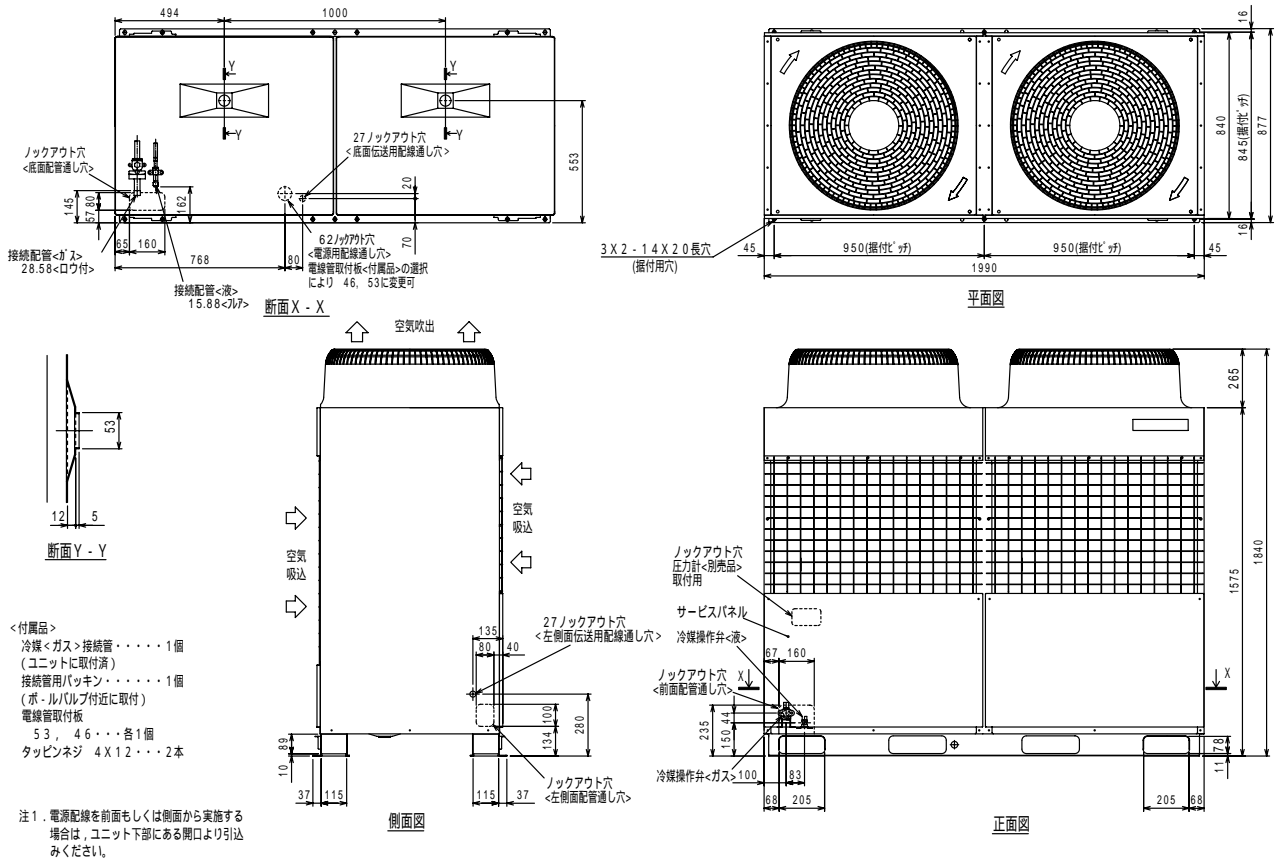

PUHY-P784・P840・P900SM-E

熱交換器ユニット外形図

PVHN-P100SM-E

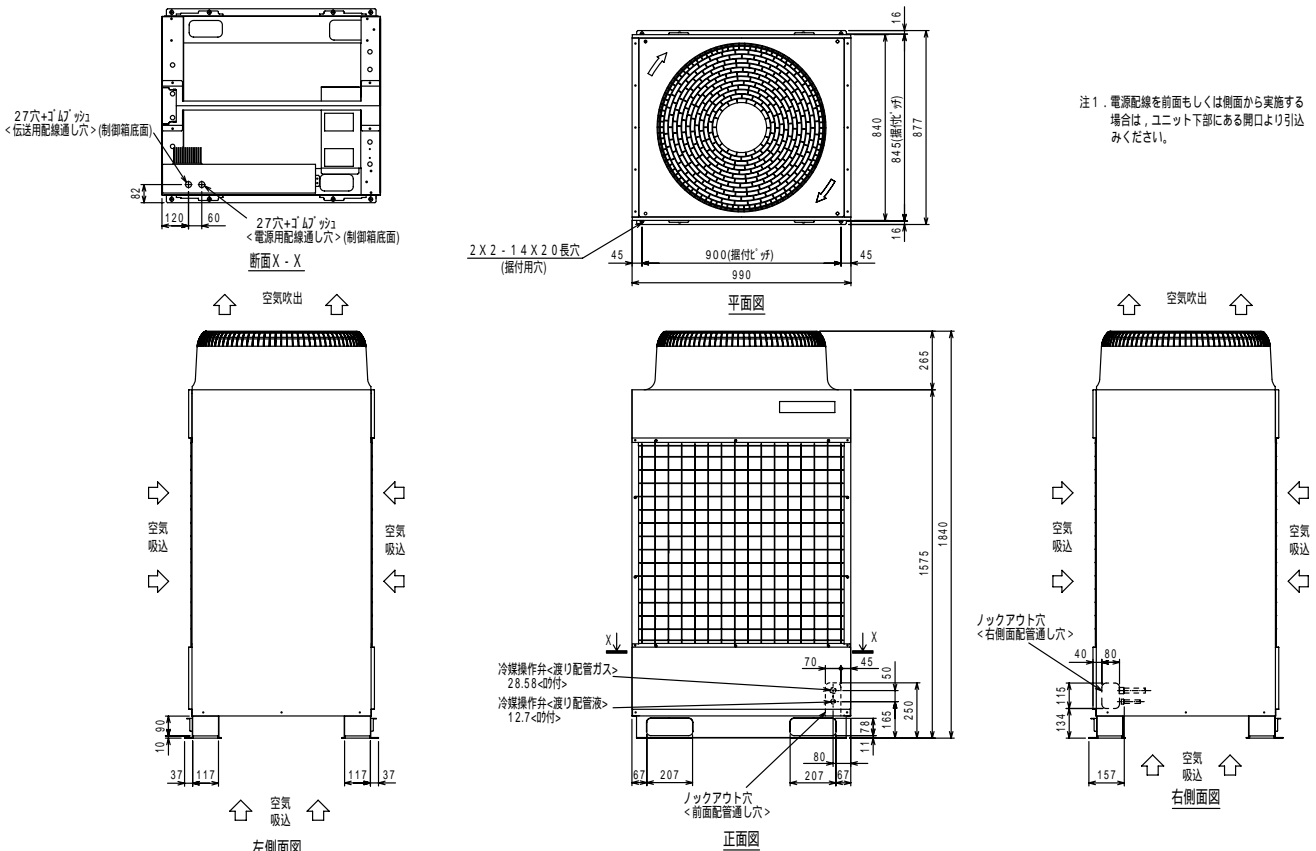

# 圧縮機ユニット外形図

## PUHY-P684・P740・P800SM-E

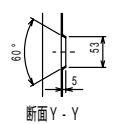
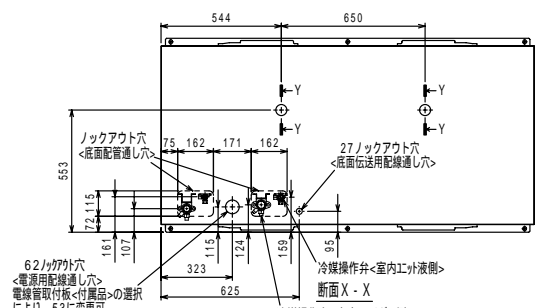

- <付属品>
- 冷媒接続管<室内ユニット側>.....1個  
(ユニットに取付済)
  - 冷媒接続管<熱交換器ユニット側>.....1個  
(ユニットに取付済)
  - 接続管用パッキン<室内ユニット側>.....1個  
(ボ・ルバルブ付近に取付)
  - 接続管用パッキン<熱交換器ユニット側>.....1個  
(ボ・ルバルブ付近に取付)
  - 冷媒接続管<室内ユニット側>.....1本  
(付属品内に底面用, 前面用各1個同梱)
  - 冷媒接続渡り配管<熱交換器ユニット側>.....1個
  - 冷媒接続渡り配管<熱交換器ユニット側>.....1個
  - 電線管取付板.....1個
  - 53.....1個
  - 配線固定板.....1個
  - タッピンネジ 4 X 12.....4本

注1. 電源配線を前面もしくは側面から実施する場合は、ユニット下部にある開口より引込みください。

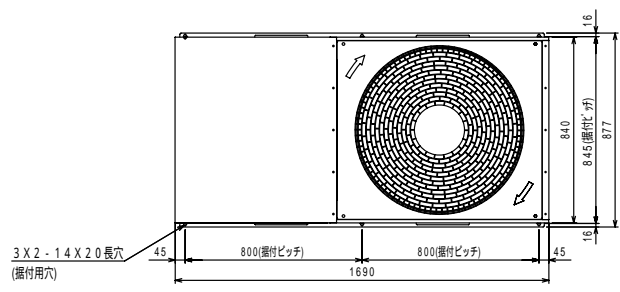

平面図

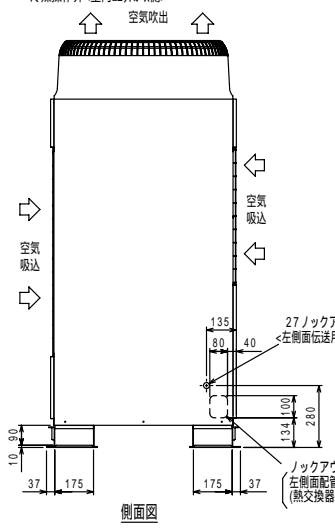

側面図

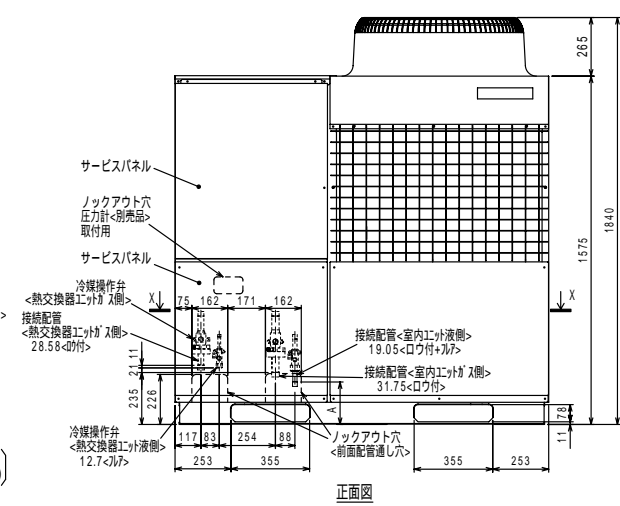

正面図

配管取出し方向	A
底面の場合	192
前面の場合	161

### セット外形図

PUHY-P784SM-E  
 PUHY-P840SM-E  
 PUHY-P900SM-E

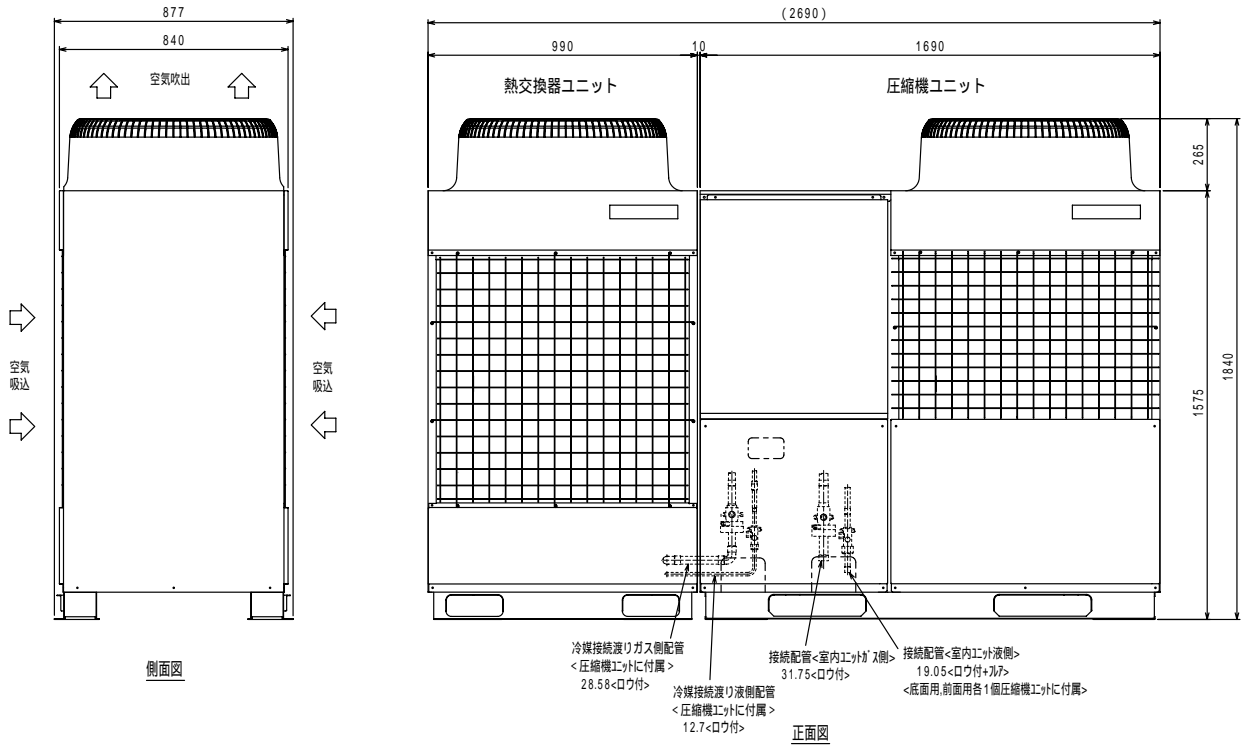

### PUHY-P960 ~ P1400SKM-E

### システムユニット外形図

PUHY-P500・560・630・670・730SM-E

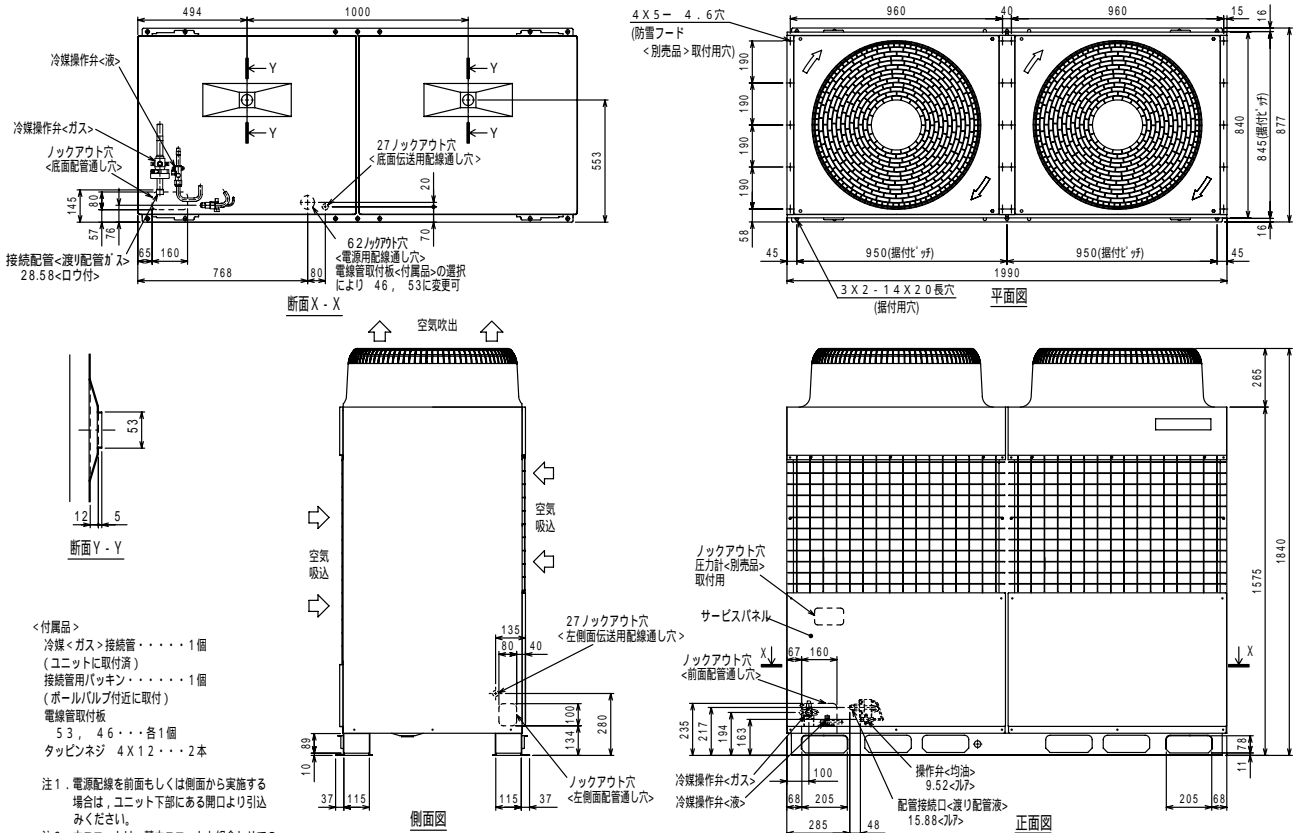

- <付属品>
- 冷媒<ガス>接続管.....1個 (ユニットに取付済)
  - 接続管用パッキン.....1個 (ボールバルブ付近に取付)
  - 電線管取付板 53, 46.....各1個
  - タピンネジ 4 X 12.....2本

注1 電源配線を前面もしくは側面から実施する場合は、ユニット下部にある開口より引込みください。

注2 本ユニットは、基本ユニットと組み合わせでの使用となります。セット外形図を参照してください。



### 室外ユニットオプション

		後配管キット	防雪フード		導風ダクト (吹出側)	室外ユニット用 集中ドレンパン	圧力計	
			吹出側	吸込側				
室外 ユニット 形名	基本ユニット	PAC-KL61RPT	PAC-KJ71TD	PAC-KJ81SD	PAC-KB72TD	PAC-KJ91DP	PAC-KK63PG	
								PUHY-P140M-E
								PUHY-P160M-E
								PUHY-P224M-E
								PUHY-P280M-E
		PUHY-P335M-E						
		PUHY-P355M-E						
		PUHY-P400M-E						
		PUHY-P450M-E						
		PUHY-P500M-E						
	PAC-KL62RPT	PAC-KJ72TD	PAC-KJ82SD	PAC-KB73TD	PAC-KJ92DP			
						PUHY-P560M-E		
						PUHY-P600M-E		
						PUHY-P630M-E		
						PUHY-P674M-E		
	PAC-KL63RPT	PAC-KJ73TD	PAC-KJ83SD	PAC-KB74TD	PAC-KJ93DP			
						PUHY-P730M-E		
						PUHY-P770M-E		
						PUHY-P800M-E		
						PUHY-P840M-E		
圧縮機ユニット	PAC-KJ71TD	PAC-KL86SD	PAC-KB72TD	PAC-KL99DP				
					PUHY-P740SM-E			
					PUHY-P800SM-E			
熱交換器ユニット	PAC-KL87SD	PAC-KJ91DP						
			PVHN-P100SM-E					
システムユニット	PAC-KJ73TD	PAC-KJ83SD	PAC-KB74TD	PAC-KJ93DP				
					PUHY-P500SM-E			
					PUHY-P560SM-E			
					PUHY-P630SM-E			
基本ユニット	PAC-KJ73TD	PAC-KJ83SD	PAC-KB74TD	PAC-KJ93DP				
					PUHY-P670SM-E			
					PUHY-P730SM-E			
PUHY-P450KM-E								
PUHY-P730KM-E								

### 高調波対策用アクティブフィルター

高調波対策用 アクティブフィルター (内蔵形)	アクティブフィルター-本体	形名	備考
		取付部品	PAC-KB50AAC
		PAC-KL56FAC	PUHY-P280・P335・P355・P400・P500・P560M-E
		PAC-KL57FAC	PUHY-P784・P840・P900SM-E
		PAC-KL58FAC	PUHY-P450・P630・P674・P730M-E PUHY-P500・P560・P630・P674・P730SM-E PUHY-P450・P730KM-E

### 室外ユニットシステムオプション

部品名	形名
外部入力用アダプター	PAC-SC36NA
外部出力用アダプター	PAC-SC37SA
Web対応集中コントローラー	G-50
スケジュールタイマー	PAC-YT34ST
ON/OFFリモコン	PAC-YT40ANR
システムリモコン	PAC-SF44SR
グループリモコン	PAC-SC30GR
伝送線用給電ユニット	PAC-SC50KU
伝送線用給電拡張ユニット	PAC-SF46EP

### サービス部品 (補修塗料)

部品名	部品コード	仕様
トリョウクミタテ	R61 A45010	5Y 8/1

### 分岐ジョイント・ヘッダー

分岐管の種類	区分	形名	対応室外ユニット																									
			P140	P160	P224	P280	P335	P355	P400	P450	P500	P560	P630	P674	P730	P784	P840	P900	P960	P1010	P1080	P1130	P1180	P1240	P1300	P1360	P1400	
分岐ジョイント	下流側室内ユニット 合計容量	P224以下	CMY-Y102S-D																									
		P225-P450	CMY-Y102L-D																									
		P451-P730	CMY-Y202-D																									
		P731以上	CMY-Y302-D																									
分岐ヘッダー	下流側室内ユニット合計容量P224以下	4分岐用	CMY-Y104-D																									
	下流側室内ユニット合計容量P450以下	8分岐用	CMY-Y108-D																									
	下流側室内ユニット合計容量P730以下	10分岐用	CMY-Y1010-D																									

分岐ジョイントCMY-Y302-Dを使用する場合は、支流側の室内ユニット接続合計容量は必ずP730以下としてください。

## 2.室内ユニット

### (1)仕様表

#### 天井カセット形：PLFY-AM(H)-E1

		PLFY-P22AM-E1	PLFY-P28AM-E1	PLFY-P36AM(H)-E1	PLFY-P45AM(H)-E1	PLFY-P56AM(H)-E1	PLFY-P71AM(H)-E1	PLFY-P80AM(H)-E1	PLFY-P90AM(H)-E1	PLFY-P112AM(H)-E1	PLFY-P140AM(H)-E1	PLFY-P160AM(H)-E1				
電源		ヒーターレス：単相 200V 50/60Hz ヒーター付：三相 200V 50/60Hz														
冷房能力	kW	2.2	2.8	3.6	4.5	5.6	7.1	8.0	9.0	11.2	14.0	16.0				
暖房能力	kW	2.5	3.2	4.0(5.4)	5.0(6.4)	6.3(7.7)	8.0(10.1)	9.0(11.1)	10.0(12.1)	12.5(15.1)	16.0(19.0)	18.0(21.0)				
電気特性	消費電力	冷房 kW	0.09/0.10		0.10/0.11		0.11/0.12		0.13/0.14		0.15/0.16		0.17/0.17			
	電力	暖房 kW	0.09/0.10		0.10/0.11 (1.50/1.51)		0.11/0.12 (1.51/1.52)		0.13/0.14 (2.23/2.24)		0.15/0.16 (2.25/2.26)		0.17/0.17 (2.27/2.28)		0.17/0.17 (3.17/3.17)	
	電流	冷房 A	0.50/0.53		0.54/0.57		0.59/0.63		0.70/0.72		0.81/0.82		0.91/0.92		0.94/0.94	
		暖房 A	0.50/0.53		0.54/0.57 (4.33/4.36)		0.59/0.63 (4.36/4.39)		0.70/0.72 (6.44/6.47)		0.81/0.82 (6.50/6.52)		0.91/0.92 (6.56/6.58)		0.94/0.94 (8.01/8.01)	
外装 (マンセルNo.)		標準化粧パネル マンセル (6.4Y 8.9/0.4)														
外形寸法	高さ<H>	mm		258(30)						298(30)						
	幅<W>	mm		840(950)												
	奥行<D>	mm		840(950)												
熱交換器形式		クロスフィン														
形式×個数		ターボファン×1														
送風機	風量(強/中1/中2/弱) m³/min	12.5-12-11.5-11	14-13-12-11	16-14-13-12			18-16-15-14	20-18-16-15	22-20-18-16	28-26-23-20	30-28-25-22					
	機外静圧 Pa	0														
	電動機出力 kW	0.035						0.110								
防音・断熱材		ポリエチレンシート														
エアフィルター		PPハニカム織 (ロングライフフィルター、抗菌仕様)														
補助電気ヒーター kW		-	1.4			2.1			2.6	3.0						
冷媒配管寸法	ガス側 mm	12.7						15.88								
	液側 mm	6.35						9.52								
ドレン配管寸法		VP-25接続可														
騒音値(強/中1/中2/弱) dB[A特性]		30-29-28-27	31-29-28-27	32-30-28-27			33-31-29-28	34-32-30-28	37-35-32-30	40-38-35-32	44-42-39-36					
製品質量	ヒーターレス kg	22(5)			24(5)			30(5)	30(5)							
	ヒーター付 kg	-	24(5)			26(5)			32(5)	32(5)						

注1. 冷房・暖房能力は、JIS8615-1条件<冷房時：室内側吸込空気温度乾球温度27、湿球温度19.0、室外側吸込空気温度乾球温度35、暖房時：室内側吸込空気温度乾球温度20、室外側吸込空気温度乾球温度7、湿球温度6>によります。

注2. 外形寸法と製品質量の( )内数値は、化粧パネルの値です。

注3. 能力と電気特性の( )内数値は、ヒーター付き機種種のヒーター作動時の値です。

#### 天井カセット形：PLFY-JM-E1

		PLFY-P36JM-E1	PLFY-P45JM-E1	PLFY-P56JM-E1	PLFY-P71JM-E1	
電源		単相 200V 50/60Hz				
冷房能力	kW	3.6	4.5	5.6	7.1	
暖房能力	kW	4.0	5.0	6.3	8.0	
電気特性	消費電力	冷房 kW	0.08/0.09		0.09/0.10	0.10/0.11
	電力	暖房 kW	0.08/0.09		0.09/0.10	0.10/0.11
	電流	冷房 A	0.45/0.50		0.50/0.55	0.55/0.60
		暖房 A	0.45/0.50		0.50/0.55	0.55/0.60
外装 (マンセルNo.)		標準化粧パネル マンセル (6.4Y 8.9/0.4)				
外形寸法	高さ<H>	mm				298(30)
	幅<W>	mm				660(760)
	奥行<D>	mm				660(760)
熱交換器形式		クロスフィン				
形式×個数		ターボファン×1				
送風機	風量(強/弱) m³/min	15.0-14.5-14.0-13.0		16.0-15.0-14.0-13.0	17.0-16.0-15.0-14.0	
	機外静圧 Pa	0				
	電動機出力 kW	0.030				
防音・断熱材		ポリエチレンシート				
エアフィルター		PPハニカム織 (抗菌仕様)				
冷媒配管寸法	ガス側 mm	12.7			15.88	
	液側 mm	6.35			9.52	
ドレン配管寸法		VP-25接続可				
騒音値(強/弱) dB[A特性]		35-34-32.5-31		37-35.5-34-32	39-38-36.5-35	
製品質量 kg		19(3.7)		20(3.7)	20(3.7)	

注1. 冷房・暖房能力は、JIS8615-1条件<冷房時：室内側吸込空気温度乾球温度27、湿球温度19.0、室外側吸込空気温度乾球温度35、暖房時：室内側吸込空気温度乾球温度20、室外側吸込空気温度乾球温度7、湿球温度6>によります。

注2. 外形寸法と製品質量の( )内数値は、化粧パネルの値です。

## 天井カセット形：PLFY-LMD(H)-E1

		PLFY-P22LMD(H)-E1	PLFY-P28LMD(H)-E1	PLFY-P36LMD(H)-E1	PLFY-P45LMD(H)-E1	PLFY-P56LMD(H)-E1	PLFY-P71LMD(H)-E1	PLFY-P80LMD(H)-E1	PLFY-P90LMD(H)-E1	PLFY-P112LMD(H)-E1	PLFY-P140LMD(H)-E1						
電源		単相 200V 50/60Hz															
冷房能力 kW(注1・4)		2.2	2.8	3.6	4.5	5.6	7.1	8.0	9.0	11.2	14.0						
暖房能力 kW(注1・4)		2.5(3.2)	3.2(3.9)	4.0(4.7)	5.0(5.7)	6.3(7.1)	8.0(8.8)	9.0(9.8)	10.0(10.8)	12.5(13.3)	16.0(18.7)						
電気特性	消費電力	冷房 kW	0.052/0.055		0.054/0.057	0.064/0.070	0.067/0.075	0.084/0.095	0.091/0.098	0.127/0.141	0.146/0.160	0.330/0.350					
		暖房 kW(注4)	0.046/0.050		0.048/0.052	0.058/0.065	0.061/0.070	0.078/0.090	0.085/0.093	0.121/0.136	0.140/0.155	0.320/0.340					
	電流	冷房 A	0.30/0.31		0.31/0.32	0.36/0.39	0.38/0.42	0.46/0.51	0.50/0.53	0.68/0.75	0.79/0.84	1.93/2.03					
		暖房 A(注4)	0.24/0.26		0.25/0.27	0.30/0.34	0.32/0.37	0.40/0.46	0.44/0.48	0.62/0.70	0.73/0.79	1.86/1.96					
外装(マンセルNo.)		本体：溶融亜鉛メッキ鋼板、化粧パネル：ABS(マンセル6.4Y 8.9/0.4)、サービスパネル：溶融亜鉛メッキ鋼板(アクリル塗装)															
外形寸法	高さ<H> mm	290 20															
	幅<W> mm	776 1080 (946 1250)				946 1250		1446 1750		1708 2012							
	奥行<D> mm					634 710				606 710							
熱交換器形式		クロスフィン															
送風機	形式×個数	ターボファン×1							ターボファン×2		シロッコファン×4						
	風量(強/中/弱) m <sup>3</sup> /min	9.5-8.0-6.5			10.5-8.5-7.0	12.5-11.0-9.0	15.5-13.0-10.0	19.0-16.0-13.5	22.0-18.5-15.5	25.0-21.0-17.5	33.0-30.0-27.0-24.0						
	機外静圧 Pa	0															
	電動機出力 kW	0.015			0.020	0.050	0.055	0.035×2	0.040×2	0.095×2							
エアフィルター		PPハニカム織(抗菌仕様)															
補助ヒーター kW(注5)		0.66				0.75			0.75		2.70						
冷媒配管寸法	ガス側 mm	12.7					15.88										
	液側 mm	6.35					9.52										
ドレン配管寸法		PVC管 VP-25接続可															
騒音値(強/中/弱) dB[A特性]		31-28-25			34-31-27	35-32-29	37-35-30	38-34-30	38-35-31	40-37-33	43-41-39-37						
製品質量 kg(注3)	ヒーターレス	23	6.5	24	6.5	27	7.5	28	7.5	39	12.5	44	12.5	47	12.5	56	13.0
	ヒーター付	29.5	7.5	30.5	7.5	30.5	7.5	31.5	7.5	42.5	12.5	47.5	12.5	50.5	12.5	61	13.0

- 注1. 冷房・暖房能力は、JIS B 8615-1条件<冷房時：室内側吸込空気温度乾球温度27、湿球温度19、室外側吸込空気温度乾球温度35、暖房時：室内側吸込空気温度乾球温度20、室外側吸込空気温度乾球温度7、湿球温度6>によります。
- 注2. 騒音はJIS規格に準じて、反響音の少ない無響音室で測定した数値です。実際に据付けた状態で測定すると、周囲の騒音や反響等の影響を受け、表示数値より大きくなるのが普通です。
- 注3. 外形寸法と製品質量の内数値は、化粧パネルの値です。
- 注4. 能力と電気特性、外形寸法、騒音( )内数値はヒーター付機種の内数値はヒーター付機種のヒーター作動時の値です。
- 注5. ヒーター付機種は受注生産品です。

## 天井カセット形：PMFY-EM-E1

		PMFY-P36EM-E1	PMFY-P45EM-E1	PMFY-P56EM-E1	PMFY-P71EM-E1	PMFY-P80EM-E1
電源		単相 200V 50/60Hz				
冷房能力 kW		3.6	4.5	5.6	7.1	8.0
暖房能力 kW		4.0	5.0	6.3	8.0	9.0
電気特性	消費電力	冷房 kW	0.09/0.10		0.09/0.11	0.11/0.16
		暖房 kW	0.09/0.10		0.09/0.11	0.11/0.16
	電流	冷房 A	0.46/0.50		0.46/0.55	0.57/0.80
		暖房 A	0.46/0.50		0.46/0.55	0.57/0.80
外装(マンセルNo.)		本体：溶亜鋼板/パネル：溶亜鋼板アクリル樹脂塗装(6.4Y 8.9/0.4)				
外形寸法	高さ<H> mm	198(10)				
	幅<W> mm	940(1190)			1240(1490)	
	奥行<D> mm	610(690)				
熱交換器形式		クロスフィン				
送風機	形式×個数	シロッコファン×2			シロッコファン×3	
	風量(強/弱) m <sup>3</sup> /min	10.5-8/11.5-8		10.5-8.5/11.5-8.5	15.5-12.5/17-12.5	
	機外静圧 Pa	0				
	電動機出力 kW	0.04		0.05	0.08	
エアフィルター		PPハニカム織(抗菌仕様)				
冷媒配管寸法	ガス側 mm	12.7			15.88	
	液側 mm	6.35			9.52	
ドレン配管寸法		PVC管 VP-25接続可				
騒音値(強/弱) dB[A特性]		39-33/41-33		39-34/42-34	42-37/44-37	
製品質量 kg		28(5.5)			35(6.5)	

- 注1. 冷房・暖房能力は、JIS B 8615-1条件<冷房時：室内側吸込空気温度乾球温度27、湿球温度19.0、室外側吸込空気温度乾球温度35、暖房時：室内側吸込空気温度乾球温度20、室外側吸込空気温度乾球温度7、湿球温度6>によります。
- 注2. 外形寸法と製品質量の( )内数値は、化粧パネルの値です。



天井カセット形：PMFY-BM-E1

		PMFY-P22BM-E1	PMFY-P28BM-E1	PMFY-P36BM-E1	PMFY-P45BM-E1	
電源		単相 200V 50/60Hz				
冷房能力	kW	2.2	2.8	3.6	4.5	
暖房能力	kW	2.5	3.2	4.0	5.0	
電気特性	消費電力	冷房 kW 0.035/0.035			0.037/0.037	0.045/0.045
	電力	暖房 kW 0.035/0.035			0.037/0.037	0.045/0.045
	電流	冷房 A 0.20/0.20			0.21/0.21	0.26/0.26
		暖房 A 0.20/0.20			0.21/0.21	0.26/0.26
外装 (マンセルNo.)		本体：溶融鋼板 / 標準化粧パネル：ABS樹脂アクリル塗装(6.4Y8.9/0.4)				
外形寸法	高さ<H>	mm 230(30)				
	幅<W>	mm 854(1000)				
	奥行<D>	mm 395(470)				
熱交換器形式		クロスフィン				
送風機	形式×個数	ラインフローファン×1				
	風量(強/中1/中2/弱) m³/min	8.7-8.0-7.2-6.5	9.3-8.6-8.0-7.3		10.7-9.7-8.7-7.7	
	機外静圧 Pa	0				
	電動機出力 kW	0.028				
エアフィルター		PPハニカム織 (抗菌仕様)				
冷媒配管寸法	ガス側 mm	12.7				
	液側 mm	6.35				
ドレン配管寸法		PVC管 VP-20接続可				
騒音値(強/中1/中2/弱) dB[A特性]		35-33-30-27	37-36-34-32		39-37-35-33	
製品質量 kg		14(3.0)				

注1. 冷房・暖房能力は、JIS8615-1条件<冷房時：室内側吸込空気温度乾球温度27、湿球温度19.0、室外側吸込空気温度乾球温度35、暖房時：室内側吸込空気温度乾球温度20、室外側吸込空気温度乾球温度7、湿球温度6>によります。  
 注2. 外形寸法と製品質量の( )内数値は、化粧パネルの値です。

天井ビルトイン形：PDFY-M-E1

		PDFY-P22M-E1	PDFY-P28M-E1	PDFY-P36M-E1	PDFY-P45M-E1	PDFY-P56M-E1	PDFY-P71M-E1	PDFY-P80M-E1	PDFY-P90M-E1	PDFY-P112M-E1	PDFY-P140M-E1	
電源		単相 200V 50/60Hz										
冷房能力	kW	2.2	2.8	3.6	4.5	5.6	7.1	8.0	9.0	11.2	14.0	
暖房能力	kW	2.5	3.2	4.0	5.0	6.3	8.0	9.0	10.0	12.5	16.0	
電気特性	消費電力	冷房 kW 0.10/0.11		0.10/0.11	0.14/0.16	0.14/0.16	0.16/0.18	0.17/0.20	0.18/0.21	0.31/0.36	0.37/0.46	
	電力	暖房 kW 0.09/0.10		0.09/0.10	0.13/0.15	0.13/0.15	0.15/0.17	0.16/0.19	0.17/0.20	0.30/0.35	0.36/0.45	
	電流	冷房 A 0.58/0.63		0.58/0.63	0.82/0.90	0.82/0.90	0.94/1.06	0.98/1.12	0.99/1.14	1.81/2.05	2.11/2.52	
		暖房 A 0.51/0.56		0.51/0.56	0.75/0.84	0.75/0.84	0.88/1.00	0.91/1.06	0.92/1.08	1.74/1.98	2.04/2.45	
外装 (マンセルNo.)		本体：溶融亜鉛メッキ鋼板 / パネル：6.4Y8.9/0.4										
外形寸法	高さ<H>	mm 295(58)										
	幅<W>	710(790)			960(1040)			1160(1240)			1510(1590)	
	奥行<D>	mm 735(600)										
熱交換器形式		クロスフィン										
送風機	形式×個数	シロッコファン×1				シロッコファン×2						
	風量(強/中1/中2/弱) m³/min	8.5-7.5-6.5-6.0			14.0-12.5-11.0-10.0	18.0-16.0-14.0-12.5	19.5-17.5-15.5-13.5	21.0-14.5	28.0-19.5	34.0-24.0		
	機外静圧 Pa	35(15,85)										
	電動機出力 kW	0.035			0.085		0.095		0.065	0.075	0.135	
エアフィルター		合成繊維不織布エアフィルター (ロングライフ・抗菌仕様)										
冷媒配管寸法	ガス側 mm	12.7						15.88				
	液側 mm	6.35						9.52				
ドレン配管寸法		外径32( PVC管 VP-25接続可)										
騒音値(強/中1/中2/弱) dB[A特性]		37-35-33-32			38-36-34-32	39-37-35-33	40-38-36-34	41-39-37-35	41-35		44-38	
製品質量 kg		25.5(5)		27(5)	32(6)	34(6)	39(7)			52(8.5)		

注1. 冷房・暖房能力は、JIS8615-2条件<冷房時：室内側吸込空気温度乾球温度27、湿球温度19.0、室外側吸込空気温度乾球温度35、暖房時：室内側吸込空気温度乾球温度20、室外側吸込空気温度乾球温度7、湿球温度6>によります。  
 注2. 外形寸法と製品質量の( )内数値は、吸込口付メンテナンスパネルの値です。  
 注3. 機外静圧欄の( )内数値は、静圧変更設定時の値です。

天井埋込形：PEFY-M-E1

		PEFY-P45M-E1	PEFY-P56M-E1	PEFY-P71M-E1	PEFY-P80M-E1	PEFY-P90M-E1	PEFY-P112M-E1	PEFY-P140M-E1	PEFY-P160M-E1	PEFY-P224M-E1	PEFY-P280M-E1		
電源		単相 200V 50/60Hz									三相 200V 50/60Hz		
冷房能力		kW	4.5	5.6	7.1	8.0	9.0	11.2	14.0	16.0	22.4	28.0	
暖房能力		kW	5.0	6.3	8.0	9.0	10.0	12.5	16.0	18.0	25.0	31.5	
電気特性	消費電力	冷房 kW	0.16/0.18	0.16/0.18	0.21/0.25	0.23/0.26	0.29/0.35	0.44/0.49	0.44/0.49	0.44/0.49	0.92/1.00	1.10/1.25	
	電力	暖房 kW	0.16/0.18	0.16/0.18	0.21/0.25	0.23/0.26	0.29/0.35	0.44/0.49	0.44/0.49	0.44/0.49	0.92/1.00	1.10/1.25	
	電流	冷房 A	0.83/0.93	0.83/0.93	1.06/1.26	1.18/1.34	1.50/1.78	2.40/2.60	2.40/2.60	2.40/2.60	3.00/3.30	3.65/4.20	
		暖房 A	0.83/0.93	0.83/0.93	1.06/1.26	1.18/1.34	1.50/1.78	2.40/2.60	2.40/2.60	2.40/2.60	3.00/3.30	3.65/4.20	
外装 (マンセルNo.)		本体：溶融亜鉛メッキ鋼板											
外形寸法	高さ<H>	mm	380						470				
	幅<W>	mm	750			1000			1200				
	奥行<D>	mm	900						1120				
熱交換器形式		クロスフィン											
送風機	形式×個数		シロッコファン×1					シロッコファン×2					
	風量 (強/弱)		m <sup>3</sup> /min	14.0-10.0	19.0-13.5	22.0-15.5	25.0-18.0	38.0-26.5	40.0-28.0	58.0	72.0		
	機外静圧		Pa	(50)・100・(200)								(100)200	
	電動機出力		kW	(0.06)・0.08・(0.13)	(0.08)・0.10・(0.18)	(0.09)・0.11・(0.19)	(0.11)・0.15・(0.23)	(0.14)・0.20・(0.37)	(0.15)・0.23・(0.40)	(0.49)・0.69	(0.67)・0.87		
エアフィルター (別売)		合成繊維不織布エアフィルター (ロングライフ・抗菌仕様)											
冷媒配管寸法	ガス側	mm	12.7			15.88					19.05	22.2	
	液側	mm	6.35			9.52							
ドレン配管寸法		外径32 (PVC管VP-25接続可)											
騒音値 (強/弱)		dB[A特性]	36-28	36-29	40-33	42-35	43-36			(44)47	(48)50		
製品質量		kg	44	45	50	70			100				

注1. 冷房・暖房能力は、JIS8615-2条件<冷房時：室内側吸込空気温度乾球温度27、湿球温度19.0、室外側吸込空気温度乾球温度35、暖房時：室内側吸込空気温度乾球温度20、室外側吸込空気温度乾球温度7、湿球温度6>によります。  
 注2. 機外静圧欄・電動機出力欄の( )内数値は、静圧変更設定時の値です。  
 注3. 電気特性・騒音値は、機外静圧100Paの時の値です。(PEFY-P224・P280M-E1は200Paの時の値です。)  
 注4. 吸込側にはエアフィルター (別途手配) を必ず使用願います。市販のエアフィルターをご使用の場合は、フィルターサービスが容易にできる場所に取付けてください。また、別売でロングライフフィルターおよび高性能フィルターを準備していますので、フィルター収納箱 (別売) と併せてご用命願います。

天袋埋込ビルトイン形：PEFY-AM-E1

		PEFY-P22AM-E1	PEFY-P28AM-E1	PEFY-P36AM-E1		
電源		単相 200V 50/60Hz				
冷房能力		kW	2.2	2.8	3.6	
暖房能力		kW	2.5	3.2	4.0	
電気特性	消費電力	冷房 kW	0.074/0.074	0.074/0.074	0.080/0.080	
	電力	暖房 kW	0.074/0.074	0.074/0.074	0.080/0.080	
	電流	冷房 A	0.37/0.37	0.37/0.37	0.40/0.40	
		暖房 A	0.37/0.37	0.37/0.37	0.40/0.40	
外装 (マンセルNo.)		本体：溶垂鋼板				
外形寸法	高さ<H>	mm	230			
	幅<W>	mm	750			
	奥行<D>	mm	400			
熱交換器形式		クロスフィン				
送風機	形式×個数		シロッコファン×2			
	風量 (強/弱)		m <sup>3</sup> /min	12.0-9.2	12.0-9.2	12.4-9.5
	機外静圧		Pa	10		
	電動機出力		kW	0.03	0.03	0.033
防音・断熱材		ポリエチレンシート				
エアフィルター		PPハニカム織				
冷媒配管寸法	ガス側	mm	12.7	12.7	12.7	
	液側	mm	6.35	6.35	6.35	
ドレン配管寸法		外径26 (PVC管 VP-20接続可)				
騒音値 (強/弱)		dB[A特性]	40-33	40-33	41-34	
製品質量		kg	21	21	21	

注1. 冷房・暖房能力は、JIS8615-2条件<冷房時：室内側吸込空気温度乾球温度27、湿球温度19.0、室外側吸込空気温度乾球温度35、暖房時：室内側吸込空気温度乾球温度20、室外側吸込空気温度乾球温度7、湿球温度6>によります。  
 注2. 騒音値は、一間天袋設置の場合の値です。

天吊形：PCFY-GM(H)-E1

		PCFY-P45GM(H)-E1	PCFY-P56GM(H)-E1	PCFY-P71GM(H)-E1	PCFY-P80GM(H)-E1	PCFY-P90GM(H)-E1	PCFY-P112GM(H)-E1	PCFY-P140GM(H)-E1	PCFY-P160GM(H)-E1	
電源		ヒーターレス：単相200V 50/60Hz				ヒーター付：三相200V 50/60Hz				
冷房能力	kW	4.5	5.6	7.1	8.0	9.0	11.2	14.0	16.0	
暖房能力	kW	5.0(6.4)	6.3(7.7)	8.0(10.1)	9.0(11.1)	10.0(12.7)	12.5(15.2)	16.0(19.0)	18.0(21.0)	
電気特性	消費電力	冷房 kW	0.10/0.11	0.10/0.11	0.13/0.15	0.13/0.15	0.15/0.18	0.15/0.18	0.20/0.24	0.20/0.24
		暖房 kW	0.10/0.11 (1.50/1.51)	0.10/0.11 (1.50/1.51)	0.13/0.15 (2.23/2.25)	0.13/0.15 (2.23/2.25)	0.15/0.18 (2.85/2.88)	0.15/0.18 (2.85/2.88)	0.20/0.24 (3.20/3.24)	0.20/0.24 (3.20/3.24)
	電流	冷房 A	0.58/0.64	0.58/0.64	0.76/0.85	0.76/0.85	0.85/0.97	0.85/0.97	1.08/1.26	1.08/1.26
		暖房 A	0.58/0.64 (4.34/4.37)	0.58/0.64 (4.34/4.37)	0.76/0.85 (6.45/6.51)	0.76/0.85 (6.45/6.51)	0.85/0.97 (8.24/8.33)	0.85/0.97 (8.24/8.33)	1.08/1.26 (9.25/9.37)	1.08/1.26 (9.25/9.37)
外装 (マンセルNo.)		鋼板ポリエステル塗装、プラスチック ホワイト(0.70Y8.59/0.97)								
外形寸法	高さ<H>	mm			210		270		270	
	幅<W>	mm			1000		1310		1620	
	奥行<D>	mm			680		680		680	
熱交換器形式		クロスフィン								
送風機	形式×個数	シロッコファン×2			シロッコファン×3			シロッコファン×4		
	風量(強/中1/中2/弱) m³/min	12.0-11.0-10.0-8.0	13.0-12.0-10.0-8.0	18.0-16.0-14.0-12.0	18.0-16.0-14.0-12.0	25.0-23.0-20.0-18.0	25.0-23.0-20.0-18.0	35.0-32.0-28.0-26.0	36.0-33.0-29.0-27.0	
	機外静圧 Pa	0								
	電動機出力 kW	0.054	0.054	0.07	0.07	0.09	0.09	0.15	0.15	
防音・断熱材		発泡PS, ポリエチレンシート								
エアフィルター		PPハニカム織 (抗菌仕様)								
補助電気ヒーター	kW	1.4	1.4	2.1	2.1	2.7	2.7	3.0	3.0	
冷媒配管寸法	ガス側 mm	12.7			15.88					
	液側 mm	6.35			9.52					
ドレン配管寸法		外径20 (PVC管 VP-20接続可)								
騒音値(強/中1/中2/弱) dB[A特性]		38-36-33-29	39-37-34-29	39-37-34-32	39-37-34-32	43-41-38-36	43-41-38-36	44-42-39-37	46-44-41-39	
製品質量	ヒーターレス kg	27	27	34	34	35	37	43	45	
	ヒーター付 kg	28.5	28.5	36	36	37.5	39.5	46	48	

注1. 冷房・暖房能力は、JIS8615-1条件<冷房時：室内側吸込空気温度乾球温度27、湿球温度19.0、室外側吸込空気温度乾球温度35、暖房時：室内側吸込空気温度乾球温度20、室外側吸込空気温度乾球温度7、湿球温度6 >によります。  
 注2. 能力と電気特性の( )内の数値は、ヒーター付き機種種のヒーター作動時の値です。  
 注3. ヒーター付機種は受注生産品です。

壁掛形：PKFY-AM-E1,PKFY-AMS-E1,PKFY-GM-E1

		PKFY-P22AM-E1	PKFY-P28AM-E1	PKFY-P22AMS-E1	PKFY-P28AMS-E1	PKFY-P36GM-E1	PKFY-P45GM-E1	PKFY-P56GM-E1	
電源		単相200V 50/60Hz				単相200V 50/60Hz			
冷房能力	kW	2.2	2.8	2.2	2.8	3.6	4.5	5.6	
暖房能力	kW	2.5	3.2	2.5	3.2	4.0	5.0	6.3	
電気特性	消費電力	冷房 kW	0.04/0.04				0.05/0.06		
		暖房 kW	0.04/0.04				0.05/0.06		
	電流	冷房 A	0.20/0.20				0.25/0.30		
		暖房 A	0.20/0.20				0.25/0.30		
外装 (マンセルNo.)		プラスチック マンセル (2.60Y8.66/0.69)				プラスチック(PS,ABS) マンセル ホワイト(0.70Y8.59/0.97)			
外形寸法	高さ<H>	mm				295			
	幅<W>	mm				815			
	奥行<D>	mm				158			
熱交換器形式		クロスフィン				クロスフィン			
送風機	形式×個数	ラインフローファン×1				ラインフローファン×1			
	風量(強/中1/中2/弱) m³/min	5.9-5.6-5.2-4.9				11.5-10.5-9.5-8.0		12.0-11.0-10.0-9.0	
	機外静圧 Pa	0				0			
	電動機出力 kW	0.017				0.03			
防音・断熱材		ポリエチレンシート				発泡ポリエチレンシート			
エアフィルター		PPハニカム織 (抗菌仕様)				PPハニカム織 (抗菌仕様)			
冷媒配管寸法	ガス側 mm	12.7				12.7			
	液側 mm	6.35				6.35			
ドレン配管寸法		断熱外径 28(VP-16接続可)				PVC管 VP-20接続可			
騒音値(強/中1/中2/弱) dB[A特性]		36-35-33-32				40-38-35-31		41-39-36-33	
製品質量	kg	8.5				16			

注1. 冷房・暖房能力は、JIS8615-1条件<冷房時：室内側吸込空気温度乾球温度27、湿球温度19.0、室外側吸込空気温度乾球温度35、暖房時：室内側吸込空気温度乾球温度20、室外側吸込空気温度乾球温度7、湿球温度6 >によります。

床置形：PFFY-DM-E1

		PFFY-P224DM-E1	PFFY-P280DM-E1	PFFY-P450DM-E1	PFFY-P560DM-E1	
電源		三相 200V 50/60Hz				
冷房能力	kW	22.4	28.0	45.0	56.0	
暖房能力	kW	25.0	31.5	50.0	63.0	
電気特性	消費電力	冷房 kW	0.74/0.75	0.82/0.81	1.30/1.63	1.84/2.19
	電力	暖房 kW	0.74/0.75	0.82/0.81	1.30/1.63	1.84/2.19
	電流	冷房 A	4.30/3.45	3.92/3.28	5.80/5.80	8.30/8.90
		暖房 A	4.30/3.45	3.92/3.28	5.80/5.80	8.30/8.90
外装 (マンセルNo.)		5Y 8/1				
外形寸法	高さ<H>	mm		1748	1899	
	幅<W>	mm	980	1200	1200	1420
	奥行<D>	mm	485		635	
熱交換器形式		クロスフィン				
送風機	形式×個数		シロッコファン×1		シロッコファン×2	
	風量	m <sup>3</sup> /min	70	90	140	180
	機外静圧	Pa	30/30	30/30	30/130	30/130
	電動機出力	kW	1.5		2.2	3.7
エアフィルター		合成繊維不織布フィルター (抗菌仕様)				
冷媒配管寸法	ガス側	mm	19.05	22.2	28.58	
	液側	mm	9.52		12.7	15.88
ドレン配管寸法		1Bオネジ接続可			1 1/4Bオネジ接続可	
騒音値	dB[A特性]	53/53	55/55	53/55	57/60	
製品質量	kg	124	148	235	257	

注1. 冷房・暖房能力は、JIS8615-2条件<冷房時：室内側吸込空気温度乾球温度27、湿球温度19.0、室外側吸込空気温度乾球温度35、暖房時：室内側吸込空気温度乾球温度20、室外側吸込空気温度乾球温度7、湿球温度6>によります。  
 注2. P224・P280DM-E形において50Hz地区の場合、モータープリー径(可変プリー)を140(出荷時は116.7)に調整した値を示します。

壁ビルトイン形：PFFY-RM-E1

		PFFY-P112RM-E1	PFFY-P140RM-E1	PFFY-P224RM-E1	PFFY-P280RM-E1	
電源		三相 200V 50/60Hz				
冷房能力	kW	11.2	14.0	22.4	28.0	
暖房能力	kW	12.5	16.0	25.0	31.5	
電気特性	消費電力	冷房 kW	0.48/0.61	0.64/0.75	1.23/1.45	1.61/1.89
	電力	暖房 kW	0.48/0.61	0.64/0.75	1.23/1.45	1.61/1.89
	電流	冷房 A	1.52/1.83	1.91/2.23	3.74/4.41	4.80/5.65
		暖房 A	1.52/1.83	1.91/2.23	3.74/4.41	4.80/5.65
外装 (マンセルNo.)		溶融亜鉛メッキ鋼板				
外形寸法	高さ<H>	mm				1950
	幅<W>	mm	980	1200	1440	
	奥行<D>	mm	500			
熱交換器形式		クロスフィン				
送風機	形式×個数		シロッコファン×2			
	風量	m <sup>3</sup> /min	32	40	64	80
	機外静圧	Pa	200/250(50/60Hz)			300
	電動機出力	kW	0.4	0.48	0.9	1.1
エアフィルター		合成繊維不織布フィルター (ロングライフ)				
冷媒配管寸法	ガス側	mm	15.88		19.05	22.2
	液側	mm	9.52			
ドレン配管寸法		外径 32(25Aオネジ接続可)				
騒音値	dB[A特性]	47/48(50/60Hz)	49/50(50/60Hz)	52.5	55	
製品質量	kg	150		180	210	

注1. 冷房・暖房能力は、JIS8615-2条件<冷房時：室内側吸込空気温度乾球温度27、湿球温度19.0、室外側吸込空気温度乾球温度35、暖房時：室内側吸込空気温度乾球温度20、室外側吸込空気温度乾球温度7、湿球温度6>によります。

### 床置埋込形：PFFY-LRM-E1

		PFFY-P28LRM-E1	PFFY-P36LRM-E1	PFFY-P45LRM-E1	PFFY-P56LRM-E1	PFFY-P71LRM-E1	
電源		単相 200V 50/60Hz					
冷房能力	kW	2.8	3.6	4.5	5.6	7.1	
暖房能力	kW	3.2	4.0	5.0	6.3	8.0	
電気特性	消費電力	冷房 kW	0.04/0.05	0.05/0.06	0.065/0.073	0.085/0.095	0.10/0.12
	電力	暖房 kW	0.04/0.05	0.05/0.06	0.065/0.073	0.085/0.095	0.10/0.12
	電流	冷房 A	0.22/0.26	0.28/0.33	0.38/0.41	0.47/0.51	0.52/0.61
		暖房 A	0.22/0.26	0.28/0.33	0.38/0.41	0.47/0.51	0.52/0.61
外装 (マンセルNo.)		溶融亜鉛メッキ鋼板					
外形寸法	高さ<H>	mm 639					
	幅<W>	886	1006		1246		
	奥行<D>	mm 220					
熱交換器形式		クロスフィン					
送風機	形式×個数	シロッコファン×1		シロッコファン×2			
	風量 (強/弱)	m³/min 6.5-5.5	9.0-7.0	11.0-9.0	14.0-12.0	15.5-12.0	
	機外静圧	Pa 0					
	電動機出力	kW 0.02	0.03	0.035	0.04	0.045	
エアフィルター		PPハニカム織 (抗菌仕様)					
冷媒配管寸法	ガス側	mm 12.7				15.88	
	液側	mm 6.35				9.52	
ドレン配管寸法		ホース付属品 27 (先端 20)					
騒音値 (強/弱)	dB[A特性]	37-31		40-34	42-37	44-38	
製品質量	kg	18.5	20	21	25	27	

注1. 冷房・暖房能力は、JIS8615-1条件<冷房時：室内側吸込空気温度乾球温度27、湿球温度19.0、室外側吸込空気温度乾球温度35、暖房時：室内側吸込空気温度乾球温度20、室外側吸込空気温度乾球温度7、湿球温度6 >によります。

### 床置形：PFFY-LEM-E1

		PFFY-P28LEM-E1	PFFY-P36LEM-E1	PFFY-P45LEM-E1	PFFY-P56LEM-E1	PFFY-P71LEM-E1	
電源		単相 200V 50/60Hz					
冷房能力	kW	2.8	3.6	4.5	5.6	7.1	
暖房能力	kW	3.2	4.0	5.0	6.3	8.0	
電気特性	消費電力	冷房 kW	0.04/0.05	0.05/0.06	0.065/0.073	0.085/0.095	0.10/0.12
	電力	暖房 kW	0.04/0.05	0.05/0.06	0.065/0.073	0.085/0.095	0.10/0.12
	電流	冷房 A	0.22/0.26	0.28/0.33	0.38/0.41	0.47/0.51	0.52/0.61
		暖房 A	0.22/0.26	0.28/0.33	0.38/0.41	0.47/0.51	0.52/0.61
外装 (マンセルNo.)		5Y 8/1					
外形寸法	高さ<H>	mm 630					
	幅<W>	1050	1170		1410		
	奥行<D>	mm 220					
熱交換器形式		クロスフィン					
送風機	形式×個数	シロッコファン×1		シロッコファン×2			
	風量 (強/弱)	m³/min 6.5-5.5	9.0-7.0	11.0-9.0	14.0-12.0	15.5-12.0	
	機外静圧	Pa 0					
	電動機出力	kW 0.02	0.03	0.035	0.04	0.045	
エアフィルター		PPハニカム織 (抗菌仕様)					
冷媒配管寸法	ガス側	mm 12.7				15.88	
	液側	mm 6.35				9.52	
ドレン配管寸法		ホース付属品 27 (先端 20)					
騒音値 (強/弱)	dB[A特性]	37-31		40-34	42-37	44-38	
製品質量	kg	23	25	26	30	32	

注1. 冷房・暖房能力は、JIS8615-1条件<冷房時：室内側吸込空気温度乾球温度27、湿球温度19.0、室外側吸込空気温度乾球温度35、暖房時：室内側吸込空気温度乾球温度20、室外側吸込空気温度乾球温度7、湿球温度6 >によります。

床置形：PSFY-GM-E1

		PSFY-P56GM-E1	PSFY-P71GM-E1	PSFY-P80GM-E1	PSFY-P112GM-E1	PSFY-P140GM-E1	PSFY-P160GM-E1	
電源		単相 200V 50/60Hz						
冷房能力	kW	5.6	7.1	8.0	11.2	14.0	16.0	
暖房能力	kW	6.3	8.0	9.0	12.5	16.0	18.0	
電気特性	消費電力	冷房 kW	0.13/0.14	0.14/0.15	0.15/0.17	0.28/0.31	0.32/0.38	0.35/0.44
		暖房 kW	0.13/0.14	0.14/0.15	0.15/0.17	0.28/0.31	0.32/0.38	0.35/0.44
	電流	冷房 A	0.65/0.71	0.71/0.77	0.75/0.84	1.52/1.71	1.61/1.97	1.76/2.23
		暖房 A	0.65/0.71	0.71/0.77	0.75/0.84	1.52/1.71	1.61/1.97	1.76/2.23
外装 (マンセルNo.)		ホワイト< 0.70Y 8.59/0.97>						
外形寸法	高さ<H>	mm 1900						
	幅<W>	mm 600						
	奥行<D>	mm 270			mm 350			
熱交換器形式		クロスフィン						
送風機	形式×個数	シロココファン×1						
	風量(強/弱) m³/min	16-13		18-15	30-24	33-26	35-27	
	機外静圧 Pa	0						
	電動機出力 kW	0.02	0.025	0.03	0.11		0.12	
エアフィルター		PPハニカム (ロングライフ)						
冷媒配管寸法	ガス側 mm	12.7		15.88				
	液側 mm	6.35		9.52				
ドレン配管寸法		VP-20						
騒音値(強/弱) dB[A特性]		38-33	40-35	42-37	48-42	49-43	52-46	
製品質量 kg		41	43		51	53		

注1. 冷房・暖房能力は、JIS8615-1条件<冷房時：室内側吸込空気温度乾球温度27、湿球温度19.0、室外側吸込空気温度乾球温度35、暖房時：室内側吸込空気温度乾球温度20、室外側吸込空気温度乾球温度7、湿球温度6>によります。

ホテル向天井埋込形：PEFY-ML-E(-R) (受注生産品)

		PEFY-P22ML-E(-R)	PEFY-P28ML-E(-R)	
電源		単相 200V 50/60Hz		
冷房能力	kW	2.2	2.8	
暖房能力	kW	2.5	3.2	
電気特性	消費電力	冷房 kW	0.06/0.06	0.06/0.07
		暖房 kW	0.06/0.06	0.06/0.07
	電流	冷房 A	0.31/0.32	0.32/0.36
		暖房 A	0.31/0.32	0.32/0.36
外装		溶融亜鉛メッキ鋼板		
外形寸法	高さ<H>	mm 292 (300)		
	幅<W>	mm 640 (640)		
	奥行<D>	mm 580 (570)		
熱交換器形式		クロスフィン		
送風機	形式×個数	シロココファン×1		
	風量(強/中/弱) m³/min	7.9/5.8/4.8		
	機外静圧 Pa	5		
	電動機出力 kW	0.023		
防音・断熱材		発泡ポリエチレン		
エアフィルター		PPハニカム		
冷媒配管寸法	ガス側 mm	12.7		
	液側 mm	6.35		
ドレン配管寸法		20A		
騒音値(強/中/弱) dB[A特性]		30/25/20		
製品質量 kg		18		

注1. 冷房・暖房能力は、JIS8615-2条件<冷房時：室内側吸込空気温度乾球温度27、湿球温度19.0、室外側吸込空気温度乾球温度35、暖房時：室内側吸込空気温度乾球温度20、室外側吸込空気温度乾球温度7、湿球温度6>によります。

注2. 外形寸法の( )内は下吹込時の値です。

厨房用：PCFY-HM-E1

		PCFY-P80HM-E1		PCFY-P140HM-E1	
電源		単相 200V 50/60Hz			
冷房能力	kW	8.0		14.0	
暖房能力	kW	9.0		16.0	
電気特性	消費電力	冷房	kW	0.13/0.14	
	電力	暖房	kW	0.13/0.14	
	電流	冷房	A	0.70/0.75	
		暖房	A	0.70/0.75	
外装		ステンレス<ヘアライン仕上げ>			
外形寸法	高さ<H>	mm		280	
	幅<W>	mm		1136	1520
	奥行<D>	mm		650	
熱交換器形式		クロスフィン			
送風機	形式×個数	シロッコファン×2		シロッコファン×4	
	風量(強/弱) m³/min	19-14		38-30	
	機外静圧	Pa		0	
	電動機出力	kW		0.04	0.08×2
防音・断熱材		発泡PS, ポリエチレンシート			
エアフィルター		合成繊維不織布			
冷媒配管寸法	ガス側	mm		15.88	
	液側	mm		9.52	
ドレン配管寸法		VP-25接続可			
騒音値(強/弱) dB[A特性]		38-32		50-44	
製品質量		kg		41	56

注1. 冷房・暖房能力は、JIS8615-1条件<冷房時：室内側吸込空気温度乾球温度27、湿球温度19.0、室外側吸込空気温度乾球温度35、暖房時：室内側吸込空気温度乾球温度20、室外側吸込空気温度乾球温度7、湿球温度6>によります。

オールフレッシュ：PEFY-M-E1-F, PFFY-RM-E1-F (受注生産品)

		PEFY-P90M-E1-F	PEFY-P112M-E1-F	PEFY-P140M-E1-F	PEFY-P160M-E1-F	PEFY-P224M-E1-F	PEFY-P280M-E1-F	PFFY-P280RM-E1-F			
電源		単相200V 50/60Hz				三相200V 50/60Hz					
冷房能力	kW	9.0	11.2	14.0	16.0	22.4	28.0	28.0			
暖房能力	kW	8.5	10.6	13.2	15.1	21.2	26.5	26.5			
電気特性	消費電力	冷房	kW	0.13/0.15		0.20/0.21		0.20/0.23	0.32/0.38	0.34/0.45	0.38/0.45
	電力	暖房	kW	0.13/0.15		0.20/0.21		0.20/0.23	0.32/0.38	0.34/0.45	0.38/0.45
	電流	冷房	A	0.70/0.77		1.03/1.12		1.06/1.17	1.08/1.29	1.15/1.52	1.22/1.42
		暖房	A	0.70/0.77		1.03/1.12		1.06/1.17	1.08/1.29	1.15/1.52	1.22/1.42
外装		本体：溶融亜鉛メッキ鋼板									
外形寸法	高さ<H>	mm		380			470	1950			
	幅<W>	mm		1000	1200		1250	1640			
	奥行<D>	mm		900			1120	500			
熱交換器形式		クロスフィン									
送風機	形式×個数	シロッコファン×1		シロッコファン×2							
	風量	m³/min		9	14		18	28	35	32.7	
	機外静圧	Pa		(60),130,(200)			(120),200		150		
	電動機出力	kW		(0.03),0.07,(0.09)	(0.04),0.08,(0.13)		(0.04),0.09,(0.14)	(0.15),0.20	(0.17),0.23	0.27	
エアフィルター		合成繊維不織布エアフィルター(ロングライフ・抗菌仕様)別売							合成繊維不織布		
冷媒配管寸法	ガス側	mm		15.88			19.05	22.2			
	液側	mm		9.52							
ドレン配管寸法		外径32(VP-25接続可)							25Aオネジ接続可		
騒音値		dB[A特性]		(26)・36・(41)		(30)・37・(41)	(37)・42	(40)・43	48		
製品質量		kg		50	70		100	210			

注1. 冷房・暖房能力は、JIS8615-2条件<冷房時：室内側吸込空気温度乾球温度33、湿球温度28.0、室外側吸込空気温度乾球温度33、暖房時：室内側吸込空気温度乾球温度0、湿球温度-2.9、室外側吸込空気温度乾球温度0、湿球温度-2.9>によります。

注2. 機外静圧、電動機出力、騒音値で( )内値は、静圧変更設定時の値です。

クリーンルーム用：PLFY-CLMD-E1（受注生産品）

		PLFY-P36CLMD-E1	PLFY-P45CLMD-E1	PLFY-P56CLMD-E1	PLFY-P71CLMD-E1	PLFY-P80CLMD-E1		
電源		単相 200V 50/60Hz						
冷房能力	kW	3.6	4.5	5.6	7.1	8.0		
暖房能力	kW	4.0	5.0	6.3	8.0	9.0		
電気特性	消費電力	冷房 kW	0.32/0.36		0.33/0.39		0.50/0.55	
	電力	暖房 kW	0.32/0.36		0.33/0.39		0.50/0.55	
	電流	冷房 A	1.82/2.05		1.88/2.21		2.85/3.13	
		暖房 A	1.82/2.05		1.88/2.21		2.85/3.13	
外装（マンセルNo.）		本体：溶融亜鉛メッキ鋼板 / パネル：マンセル 0.70Y 8.59/0.97						
外形寸法	高さ<H>	mm 460						
	幅<W>	840	995		1300			
	奥行<D>	mm 1300(1700)						
熱交換器形式		クロスフィン						
送風機	形式×個数		シロココファン×1					
	風量（強/弱）m <sup>3</sup> /min		18-15	20-17		24-20		
	機外静圧 Pa		38(下吸込ボックス装着時は0)			28(下吸込ボックス装着時は0)		
	電動機出力 kW		0.28					
冷媒配管寸法	ガス側	mm 6.35			9.52			
	液側	mm 12.7			15.88			
ドレン配管寸法		外径32（VP-25接続可）						
騒音値（強/弱）dB[A特性]		39/37	40/38.5		42/39			
製品質量 kg		100	110		130			

注1. 冷房・暖房能力は、JIS8615-1条件<冷房時：室内側吸込空気温度乾球温度27、湿球温度19.0、室外側吸込空気温度乾球温度35、暖房時：室内側吸込空気温度乾球温度20、室外側吸込空気温度乾球温度7、湿球温度6>によります。

注2. 外形寸法の（ ）内数値は、下吸込化粧パネルの値です。



## (2) 外形図

### 天井カセット形：PLFY-P22, P28AM-E1

### PLFY-P36, P45, P56, P71, P80, P90, P112, P140, P160AM(H)-E1

- 注 1 化粧パネルは標準パネル、カタン自動パネルからお選びください。  
 2 ドレン配管はPVC管VP-25を使用してください。  
 ドレンポンプ内蔵です。最大揚程は天井面から850mmです。  
 3 吊りボルトはM10またはW3/8ネジを使用してください。(現地手配)  
 4 サ・ビス時、電気品箱を外す事があります。電源線並びに制御線の接続時には、電線に十分な余裕を持たせてください。  
 5 カタンコーナーポケットより、化粧パネルを付けたまま本体の高さ調整が可能です。  
 6 別売加湿器(別吊り型)、取付時は天井ふところ高さが、360mm以上必要となります。  
 7 別売多機能ケースメントおよび別売高性能フィルター取付時の注意  
 1) 天井ふところ高さが下表以上必要となります。

P22-P90形	400
P112-P160形	440

- 2) 図中の 印部の寸法は、13.5mm加算されます。  
 3) 別売高性能フィルターは、多機能ケースメントと併用となります。  
 8. 分ダクト接続時は、十分な断熱を行ってください。  
 (露付、露たれの原因になります。)

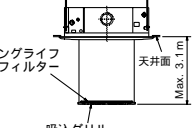
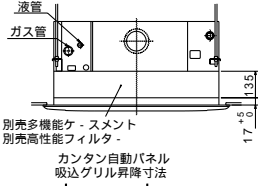

カタン自動パネル  
吸込グリル昇降寸法

Langraif  
フィルター

吸込グリル  
(1.3m/1.8m/2.4m/3.1mの4段階の設定可能)

MAススムリモコン(ケーブルは付いていません) MEリモコン(ケーブルは付いていません)  
(別売部品: PAR-22MA) (別売部品: PAR-F27ME)

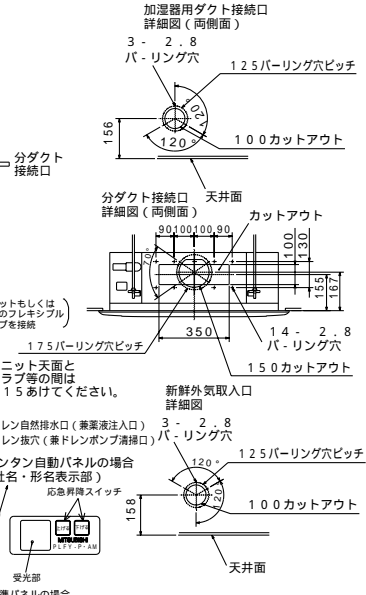
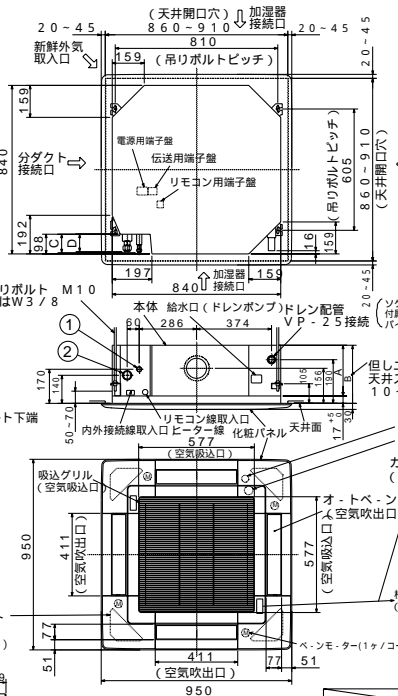
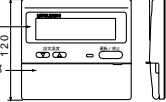
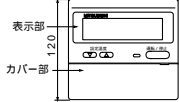

			A	B	C	D
P22-P56形	冷媒配管	6.35	241	258	85	76
	フレア接続	1/4F				
P71-P90形	冷媒配管	9.52	89	80		
	フレア接続	3/8F				
P112-P160形	冷媒配管	9.52	281	298		
	フレア接続	3/8F				

### 天井カセット形：PLFY-JM-E1

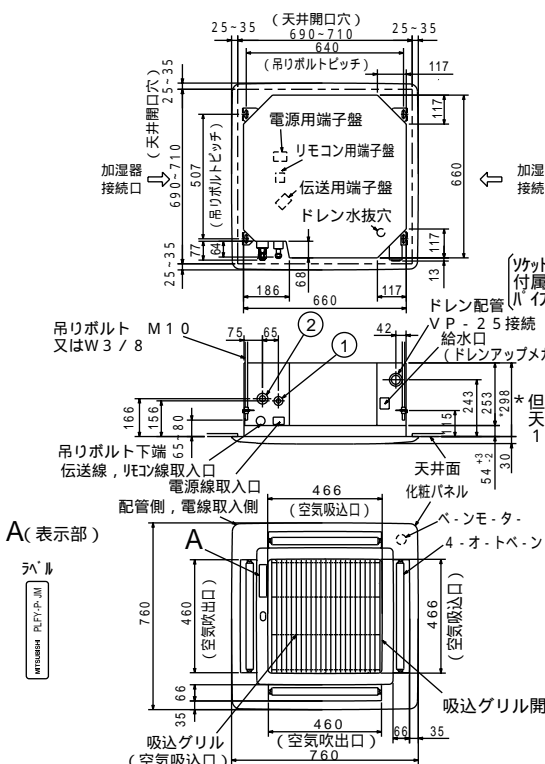

- 注 1 別売加湿器(別吊り型)取付時は天井ふところ高さが、360以上必要となります。  
 2 サ・ビス時、電気品箱を外す事があります。電源線並びに制御線の接続時には、電線に十分な余裕を持たせてください。  
 3 別売高性能フィルター-取付時は天井ふところ高さが、440以上必要となります。また、別売多機能ケースメント使用の場合も、取付時天井ふところ高さが、440以上必要となります。(別売高性能フィルター-も取付が可能です。)  
 4 ドレンポンプ内蔵です。最大揚程は天井面から600mmです。

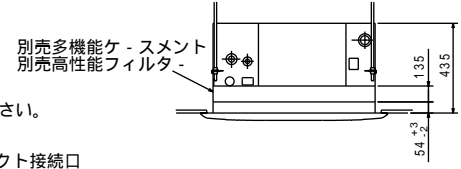

	①(液)	②(ガ)
P36-P56形	冷媒配管 6.35 フレア接続 1/4F	冷媒配管 12.7 フレア接続 1/2F
P71形	冷媒配管 9.52 フレア接続 3/8F	冷媒配管 15.88 フレア接続 5/8F

## 天井カセット形：PLFY-P22,P28,P36,P45,P56,P71,P80,P90,P112LMD-E1

外気取入口 240 x 45 / ヲヅヅ

分ダクト接続口 別売加温器接続口  
FK110/分ダクト用穴(両側面)(注4)

電源用端子台

送風用端子台

制御盤

露出仕巻

天井材組込仕巻

注1. 天井材組込タイプの化粧パネルをご使用の場合  
天井材組込可能最大厚さは11mmです。  
2. 吊りボルトはM10を使用してください。(現地の手配)  
3. オプションの高性能フィルター・パウダークリアフィルター組込時は  
本体高さが110mmアップします。  
4. 分ダクト接続口は両側面にも取出し可能です。  
5. エアフィルターはパネルと同色されています。

2.2 - 4.5タイプ <配管径> <吊りボルト>  
冷媒配管(リノ)接続 1.2.7 (本体側2.8HEX, リノ側2.7HEX) ①  
# (吊り) # 6.3.5 (本体側1.7HEX, リノ側1.7HEX) ②  
5.6タイプ  
冷媒配管(リノ)接続 1.2.7 (本体側2.8HEX, リノ側2.8HEX) ①  
# (吊り) # 6.3.5 (本体側1.9HEX, リノ側2.2HEX) ②  
7.1 - 9.0タイプ  
冷媒配管(リノ)接続 1.5.8.8 (本体側2.8HEX, リノ側2.8HEX) ①  
# (吊り) # 9.5.2 (本体側1.9HEX, リノ側2.2HEX) ②  
1.1.2タイプ  
冷媒配管(リノ)接続 1.5.8.8 (本体側2.8HEX, リノ側3.8HEX) ①  
# (吊り) # 9.5.2 (本体側1.9HEX, リノ側2.2HEX) ②  
ドレンホース VP - 2.5 <リノ側接続> (付属) ③

機種	A	B	C	D	E	F	G
PLFY-P22LMD-E1							
PLFY-P28LMD-E1							
PLFY-P36LMD-E1							
PLFY-P45LMD-E1							
PLFY-P56LMD-E1							
PLFY-P71LMD-E1							
PLFY-P80LMD-E1							
PLFY-P90LMD-E1							
PLFY-P112LMD-E1							

## 天井カセット形：PLFY-P140LMD-E1

外気取入口 (150 / ヲヅヅ)

分ダクト接続口 200 / ヲヅヅ (両側面)

電源用端子台

送風用端子台

制御盤

露出仕巻

天井材組込仕巻

注1. 天井材組込タイプの化粧パネルをご使用の場合  
天井材組込可能最大厚さは21mmです。  
2. 吊りボルトはM10を使用してください。(現地の手配)  
3. オプションの高性能フィルター組込時は本体高さが110mmアップします。  
4. エアフィルターは本体側と同色されています。

<配管径> <吊りボルト>  
冷媒配管(リノ)接続 1.5.8.8 (本体側3.8HEX, リノ側3.8HEX) ①  
# (吊り) # 9.5.2 (本体側1.9HEX, リノ側2.2HEX) ②  
ドレンホース VP - 2.5 <リノ側接続> (付属) ③



# 天井ビルトイン形：PDFY-P22, P28, P36, P45, P56, P71, P80, P90M-E1

機種	A	B	C	D	E	F	G	H	J
PDFY-P22・28・36M-E1	790<1040>	750<1000>	710	686	165	320	—	<250>	20<270>
PDFY-P45・56M-E1	1040<1240>	1000<1200>	960	936	225	450	—	<200>	20<220>
PDFY-P71・80・90M-E1	1240<1590>	1200<1550>	1160	1136	230	320	320	<350>	20<370>

注：1. オプションの高性能フィルター組込時は本体高さが32mmアップします。  
 2. 天井材組込タイプの化粧パネルをご使用の場合、天井材組込可能最大厚さは20mmです。  
 3. 吊りボルトはM10を使用してください。(現地手配)  
 4. オプションの内蔵形加湿器を組込時は、加湿エレメントのメンテナンスがサイドスライドメンテになりますので、1ランク上のパネルを使用してください。(サ・ビススペースの詳細は、加湿器組込の外形図を参照ください。)

- < 2.2 - 4.5タイプ > < 配管サイズ > < スパナサイズ >  
 冷媒配管(ガス)ルア接続 12.7 (本体側2.3HEX,ルア側側2.7HEX)・・・  
 " (I) " 6.3.5 (本体側1.7HEX,ルア側側1.7HEX)・・・
- ・5.6タイプ  
 冷媒配管(ガス)ルア接続 12.7 (本体側2.6HEX,ルア側側2.9HEX)・・・  
 " (I) " 6.3.5 (本体側1.9HEX,ルア側側2.2HEX)・・・
- ・7.1 - 9.0タイプ  
 冷媒配管(ガス)ルア接続 15.8.8 (本体側2.6HEX,ルア側側2.9HEX)・・・  
 " (I) " 9.5.2 (本体側1.9HEX,ルア側側2.2HEX)・・・
- ドレン VP - 2.5<フレキシ継手2.50mm>(付属).....

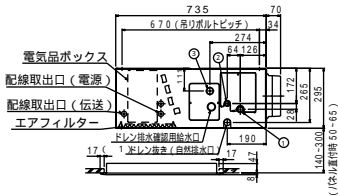

注：ドレンアップメカを御使用にならない場合は(1)部に付属のフレキシブルホースを接続してください。

上図範囲内で付属のフレキシブルホースを使用してドレン撈程の処理をお願いします。

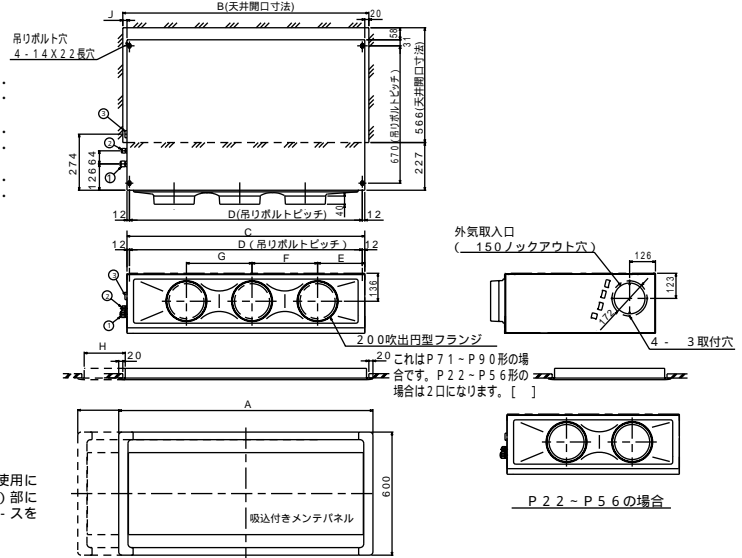

# 天井ビルトイン形：PDFY-P112, P140M-E1

- 注：1. オプションの高性能フィルター組込時は本体高さが32mmアップします。  
 2. 天井材組込タイプの化粧パネルをご使用の場合、天井材組込可能最大厚さは20mmです。  
 3. 吊りボルトはM10を使用してください。(現地手配)  
 4. オプションの内蔵形加湿器を組込時は、加湿エレメントのメンテナンスがサイドスライドメンテになりますので、1ランク上のパネルを使用してください。(サ・ビススペースの詳細は、加湿器組込の外形図を参照ください。)
- < 寸法はオプションの内蔵形加湿器組込時です。

- < 配管サイズ > < スパナサイズ >  
 冷媒配管(ガス)ルア接続 15.8.8 (本体側2.9HEX,ルア側側3.6HEX)・・・  
 " (I) " 9.5.2 (本体側1.9HEX,ルア側側2.2HEX)・・・
- ドレン VP - 2.5<フレキシ継手2.50mm>(付属).....

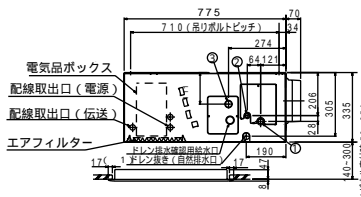

注：ドレンアップメカを御使用にならない場合は(1)部に付属のフレキシブルホースを接続してください。

上図範囲内で付属のフレキシブルホースを使用してドレン撈程の処理をお願いします。

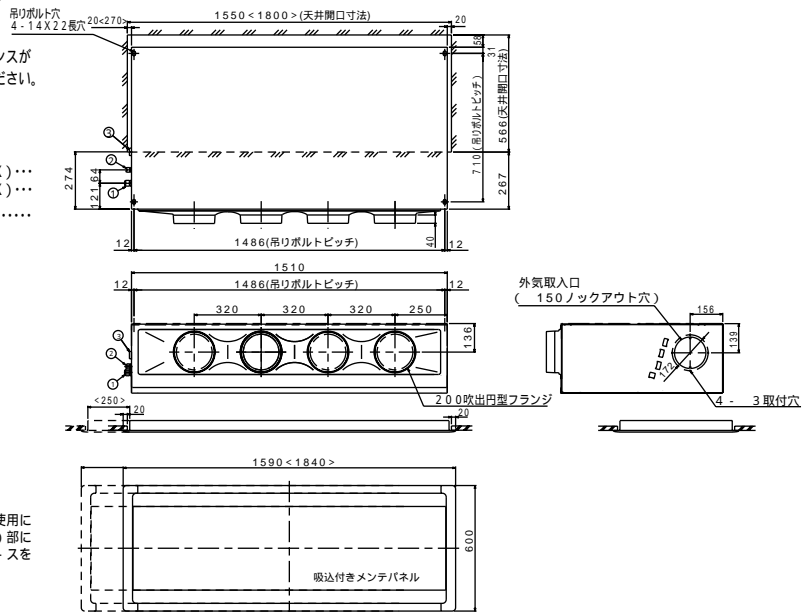

## 天井埋込形：PEFY-P45,P56,P71,P80,P90,P112,P140,P160M-E1

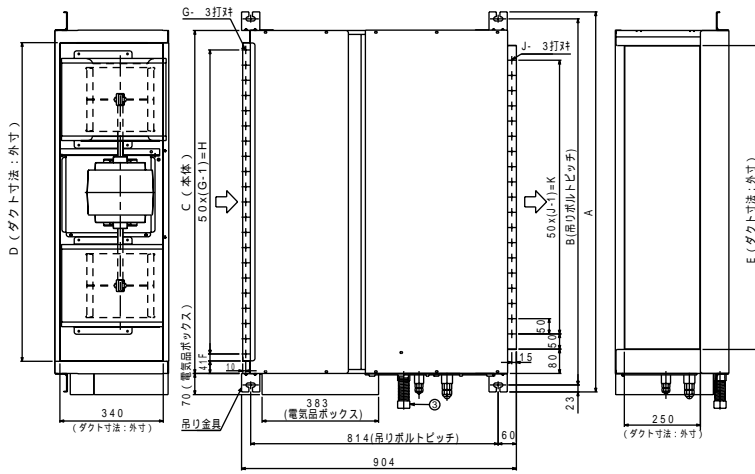

機種	A	B	C	D	E	F	G	H	J	K	L
PEFY-P45-56-71M-E1	800	754	680	600	550	50	11	500	10	450	780
PEFY-P80-90M-E1	1050	1004	930	850	800	25	17	800	15	700	1030
PEFY-P112-140-160M-E1	1250	1204	1130	1050	1000	25	21	1000	19	900	1230

- 注：1. 吊りボルトにはM10を使用してください。(現地御手配)  
 2. 別売補助電気ヒーターのメンテナンスおよび熱交換器の洗浄をする際には下からのメンテナンスとなりますので、サービススペースを確保願います。  
 3. 別売の内蔵形加湿器を組込の際は、加湿エレメントのメンテナンスのために、1ランク大きい(600×600)点検口を設けてください。  
 (サービススペースの詳細は加湿器組込の外形図を参照ください。)  
 4. 本図はファンが2つの112-160タイプを示します。45-90タイプの場合はファンが1つとなります。  
 5. 本ユニットの吸込側にはエアフィルターが必要です。フィルターメンテナンスが容易にできる位置に必ずエアフィルターを設置願います。  
 尚、別売でロングライフフィルター、高性能フィルターを準備しています。但し、前記フィルターをご使用の場合は別売フィルターボックスが必要です。  
 (フィルターボックスを使用した場合、奥行き寸法が900→998に変わります。)
- ・45タイプ <配管サイズ> <スパンサイズ>  
 冷媒配管(ガス) フレア接続 12.7 (本体側2.3HEX、フレアナット側2.7HEX)・・・①  
 " (エキ) " 6.35 (本体側1.7HEX、フレアナット側1.7HEX)・・・②
- ・56タイプ  
 冷媒配管(ガス) フレア接続 12.7 (本体側2.6HEX、フレアナット側2.9HEX)・・・①  
 " (エキ) " 6.35 (本体側1.9HEX、フレアナット側2.2HEX)・・・②
- ・71-90タイプ  
 冷媒配管(ガス) フレア接続 15.88 (本体側2.6HEX、フレアナット側2.9HEX)・・・①  
 " (エキ) " 9.52 (本体側1.9HEX、フレアナット側2.2HEX)・・・②
- ・112-160タイプ  
 冷媒配管(ガス) フレア接続 15.88 (本体側2.9HEX、フレアナット側3.6HEX)・・・①  
 " (エキ) " 9.52 (本体側1.9HEX、フレアナット側2.2HEX)・・・②
- ドレン VP-2.5<フレキ継手200mm>(付属)・・・③

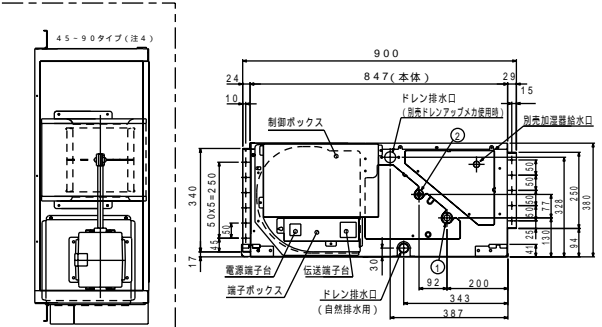

サービススペース詳細図

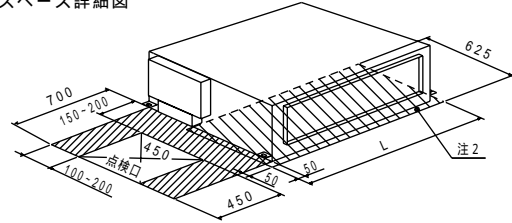

## 天井埋込形：PEFY-P224, P280M-E1

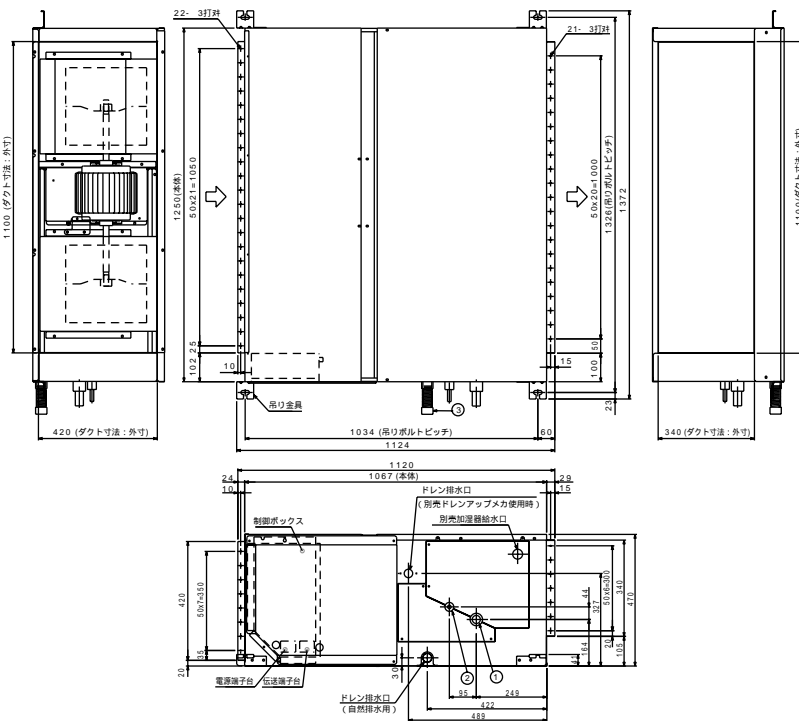

- 注：1. 吊りボルトにはM10を使用してください。(現地御手配)  
 2. 別売補助電気ヒーターのメンテナンスおよび熱交換器の洗浄をする際には下からのメンテナンスとなりますので、サービススペースを確保願います。  
 3. 別売の内蔵形加湿器を組込の際は、加湿エレメントのメンテナンスのために、1ランク大きい(600×600)点検口を設けてください。  
 (サービススペースの詳細は加湿器組込の外形図を参照ください。)
- PEFY-P224M-E1 <配管サイズ>  
 冷媒配管(ガス) ロウ付接続 19.05・・・  
 " (エキ) " 12.7・・・
- PEFY-P280M-E1 <配管サイズ>  
 冷媒配管(ガス) ロウ付接続 22.2・・・  
 " (エキ) " 12.7・・・
- ドレン VP-2.5<フレキ継手200mm>(付属)・・・

サービススペース詳細図

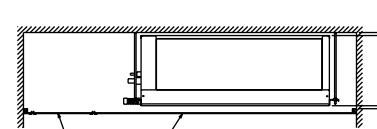
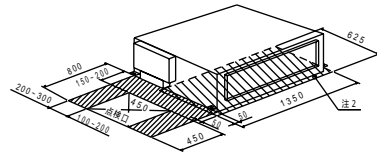

点検口 天井面  
 サービスメンテナンスのため指定位置に必ず点検口を設置してください。

天袋埋込ビルトイン形：PEFY-P22, P28, P36AM-E1

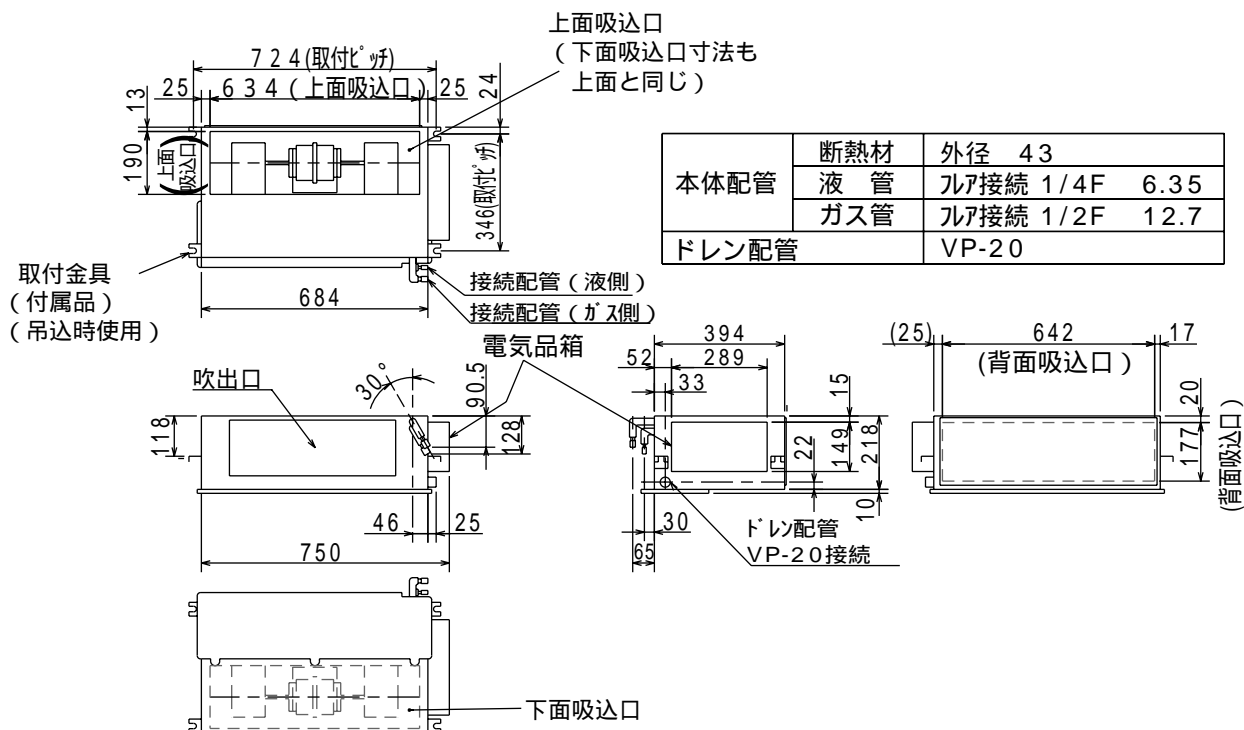

【半間幅天袋形】

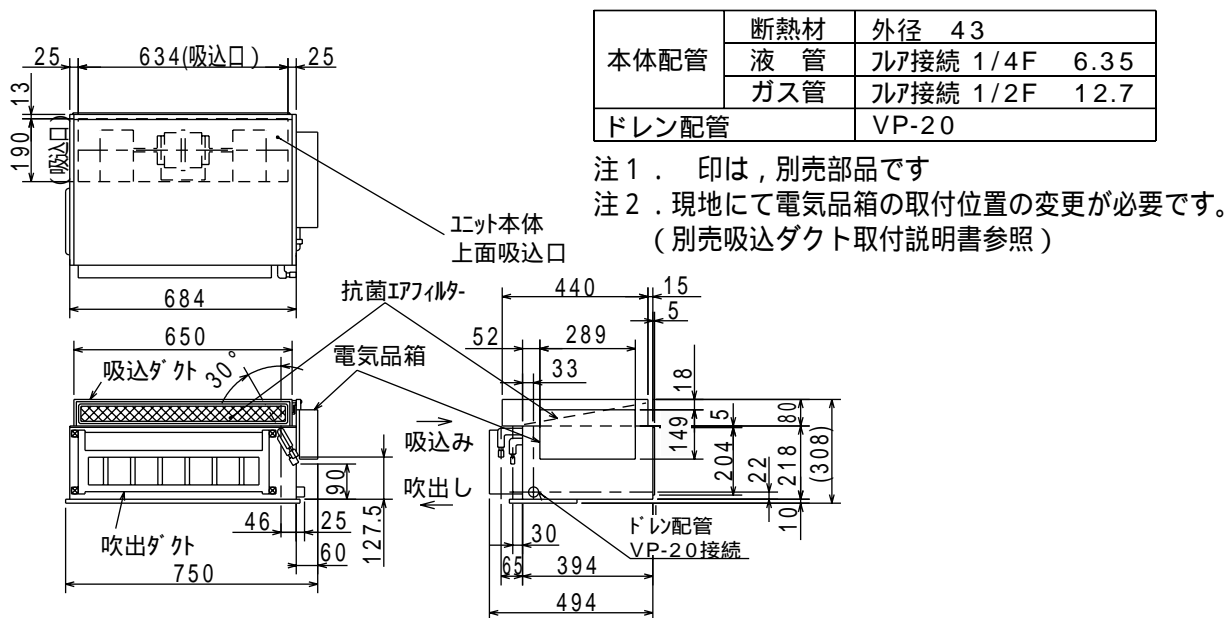

## 天吊形：PCFY-P45, P56GM(H)-E1

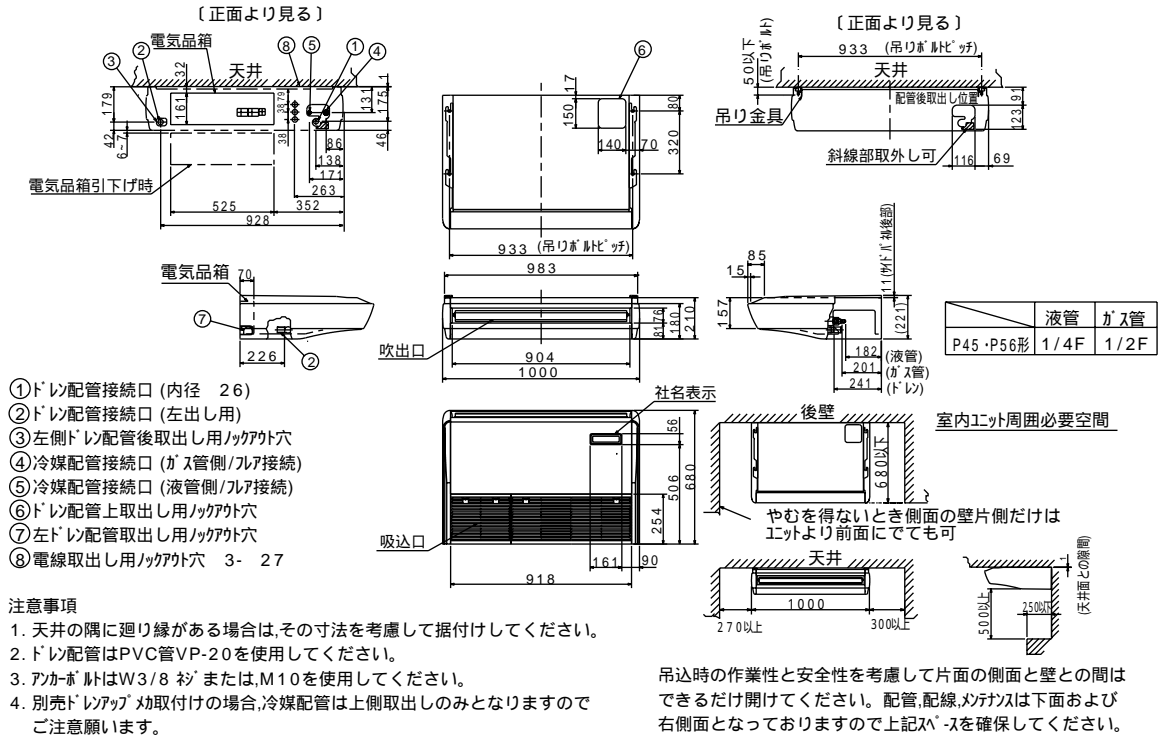

## 天吊形：PCFY-P71, P80GM(H)-E1

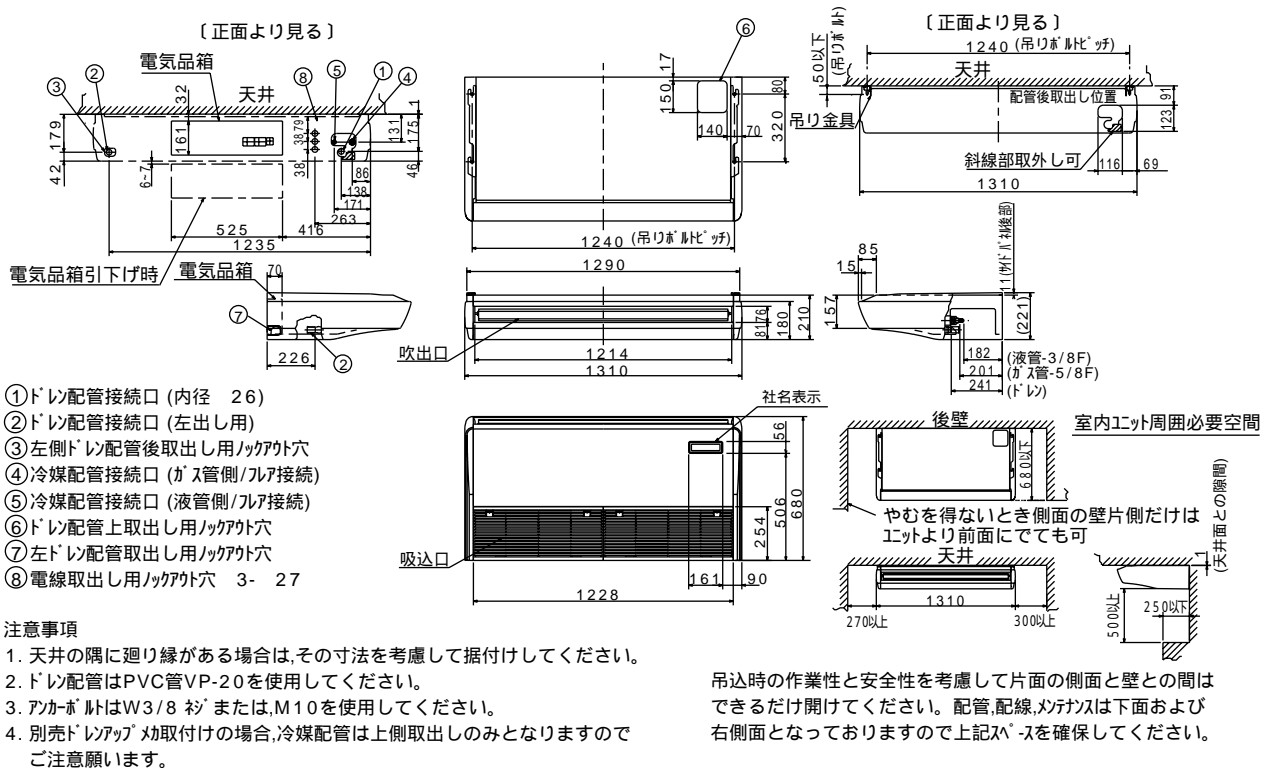

## 天吊形：PCFY-P90, P112GM(H)-E1

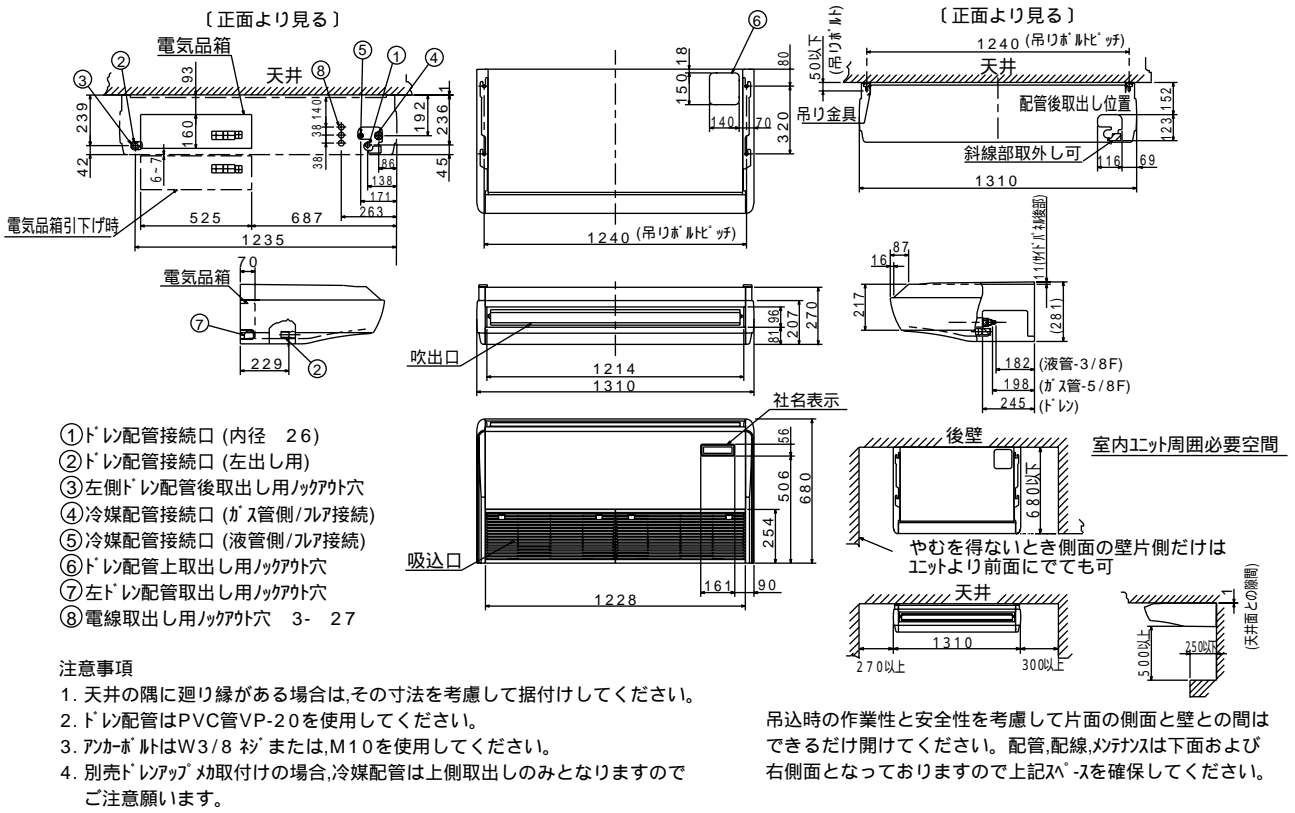

## 天吊形：PCFY-P140, P160GM(H)-E1

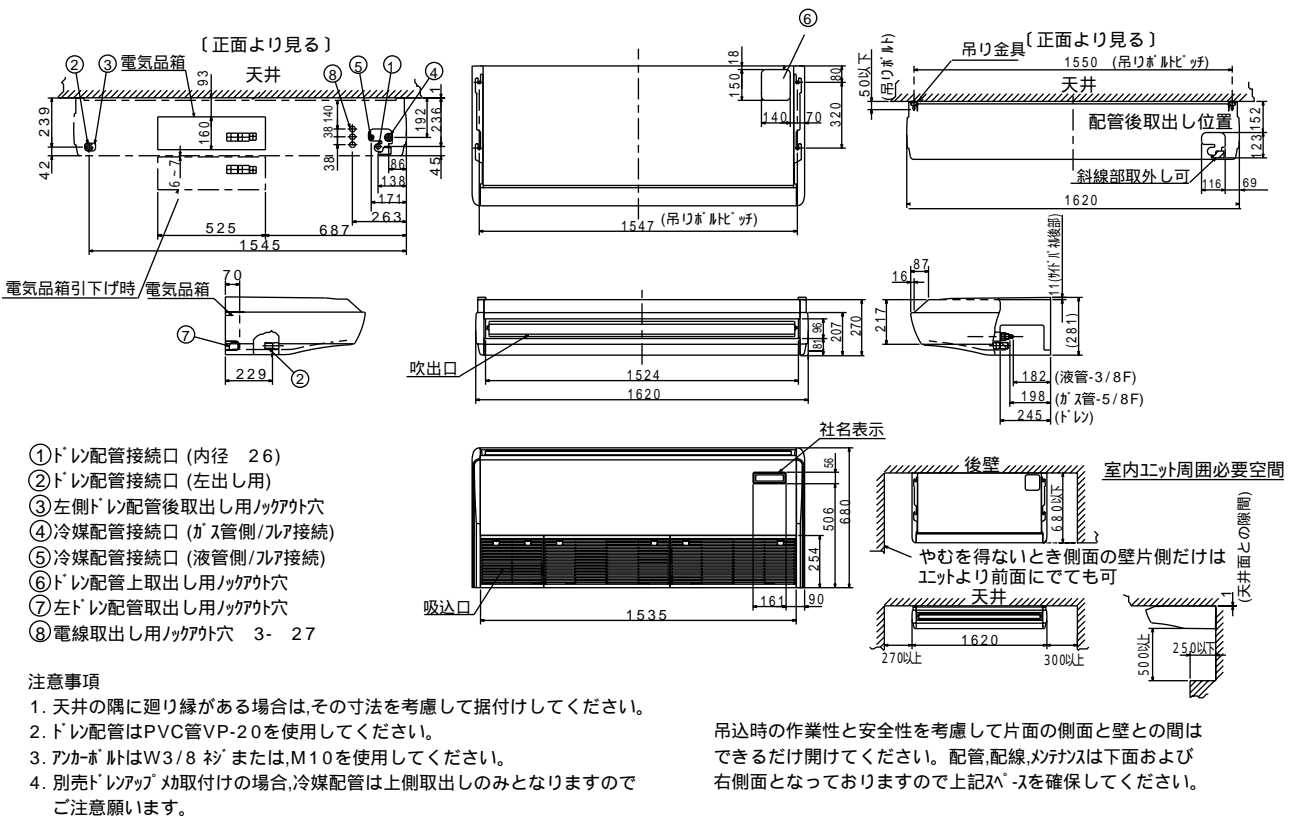



壁掛形 : PKFY-P22, P28AM-C, PKFY-P22, P28AMS-E1

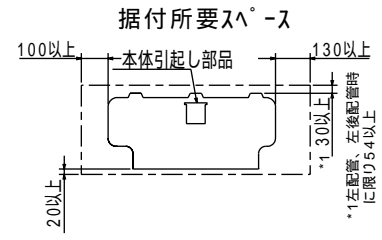
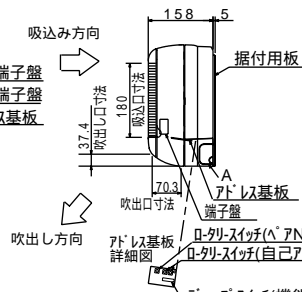
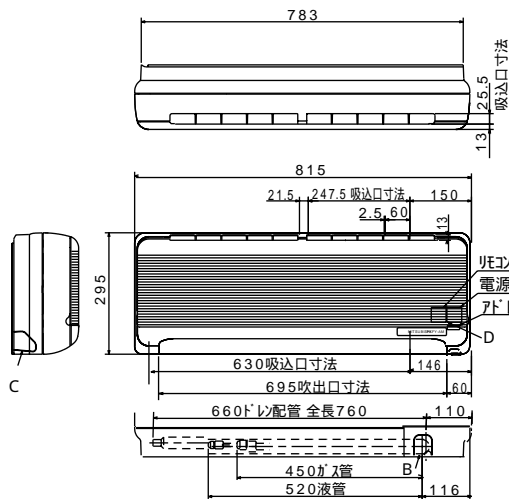

- 注1、天井の隅に廻り線がある場合は、その寸法を考慮して据付けてください。
- 注2、据付用板の取付ボルトはM10またはW3/8 ㍉を使用してください。
- 注3、制御線の接続はリド線を圧着等により結線を行ってください。
- 注4、配線工事を行う際はカバーを取外してください。
- 注5、延長配管サイズは下記仕様表を参照ください。

\*3 アド基板はプラスチックにて保護されています。設定を行う時はドライバーにてネジ(1本)をはずしてください。

ノックアウト穴 詳細図 (A B C)

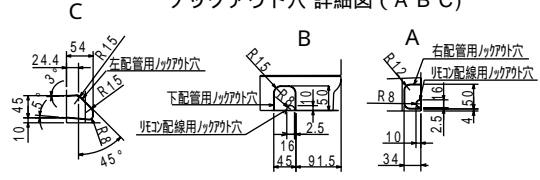

端子盤詳細図

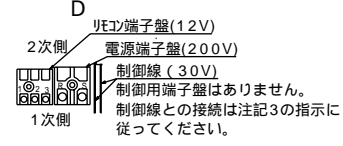

冷媒配管	断熱材	外径 35
	液管	フレア接続 1/4F
	ガス管	フレア接続 1/2F
ドレン配管	断熱材	外径 28
	接続部	外径 16



## 床置形：PFFY-P450, P560DM-E1

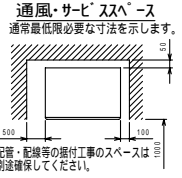
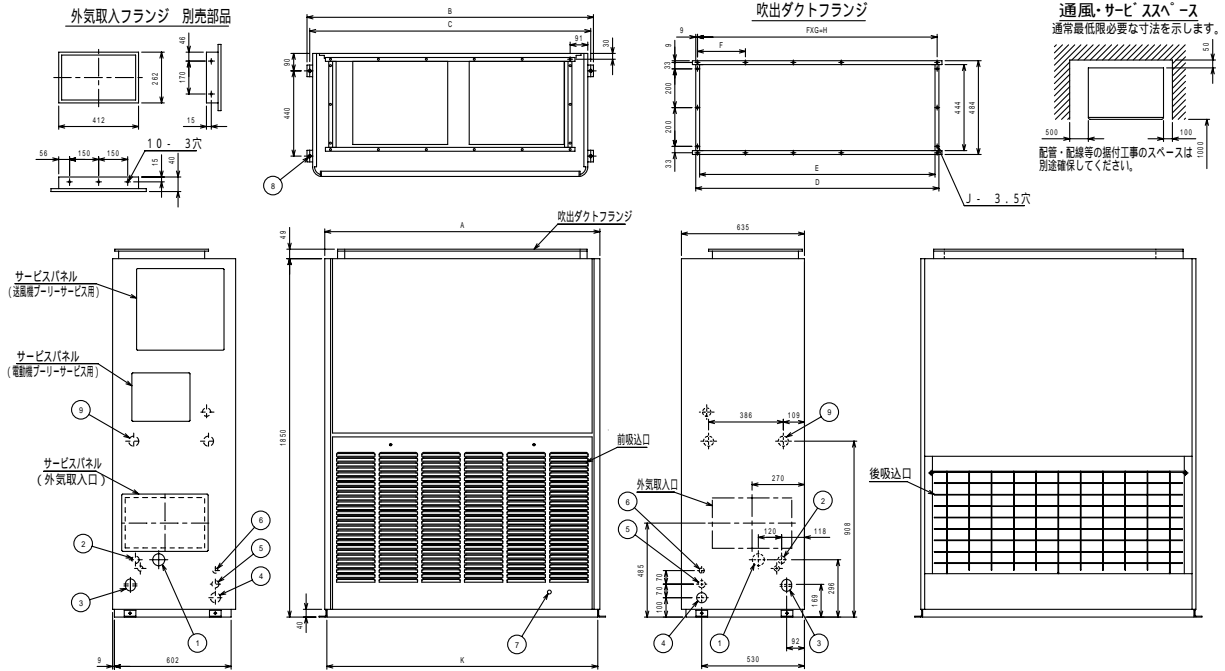

NO.	名称	NO.	名称
1	冷媒配管<ガス>… 28.58ロウ付	6	室内外連絡穴 伝送線穴… 27
2	冷媒配管<液>… Lロウ付	7	アース端子 (制御箱内に設置)… 5枚
3	ドレン穴… 1/4B	8	基礎ボルト穴… 4- 12
4	装置電源穴… 52	9	送風機加湿器配管穴… 52
5	電線穴… 37		

注1. 伝送線と電圧200V以上の配線は必ず分けた経路としてください。

注2. 設置する部屋の気密性が高い場合、室内が負圧となり、部屋の扉が開かない等の問題が発生する場合がありますので室内が負圧にならないような通気孔等を設けてください。

注3. 左配管接続する場合は、別売左配管部品が必要です。

	A	B	C	D	E	F	G	H	J	K	L
PFFY-P450DM-E1	1200	1258	1230	1046	1006	257	4	1028	16	1178	12.7
PFFY-P560DM-E1	1420	1478	1450	1255	1215	247	5	1235	18	1398	15.88

## 床置形：PSFY-GM-E1

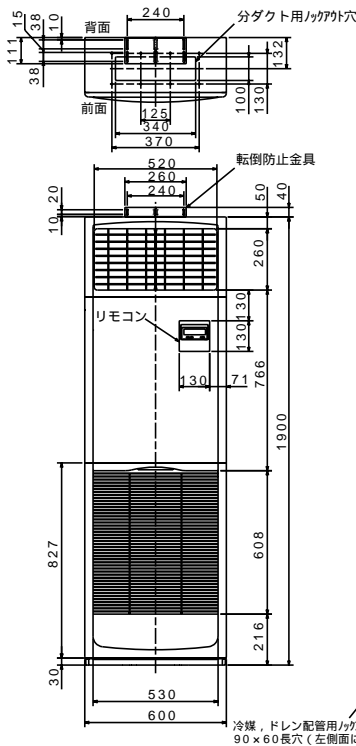

	A	B	C	D	E	F	G	H	J	K
P56~80形	270	250	180	235	55	143	160	90	175	186
P112~160形	350	330	260	315	77	201	120	140	255	261

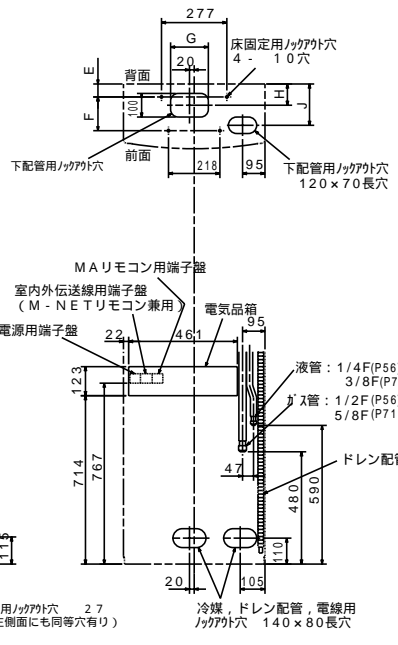

注1. ドレン配管接続部は現地工事に合わせ、加工できるようにドレンソケット (VP-20接続用) が付属品として有ります。接着してご使用ください。

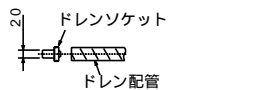

2. 分ダクトを取付ける場合は、ユニットの天井パネルに設けられたノックアウト穴および分ダクト取付け用ネジ穴に金具がはかからないようにしてください。(転倒防止金具の長辺を壁側にすればかかるとはなりません。)

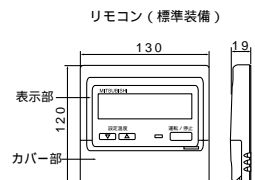

## 壁ビルトイン形：PFFY-RM-E1

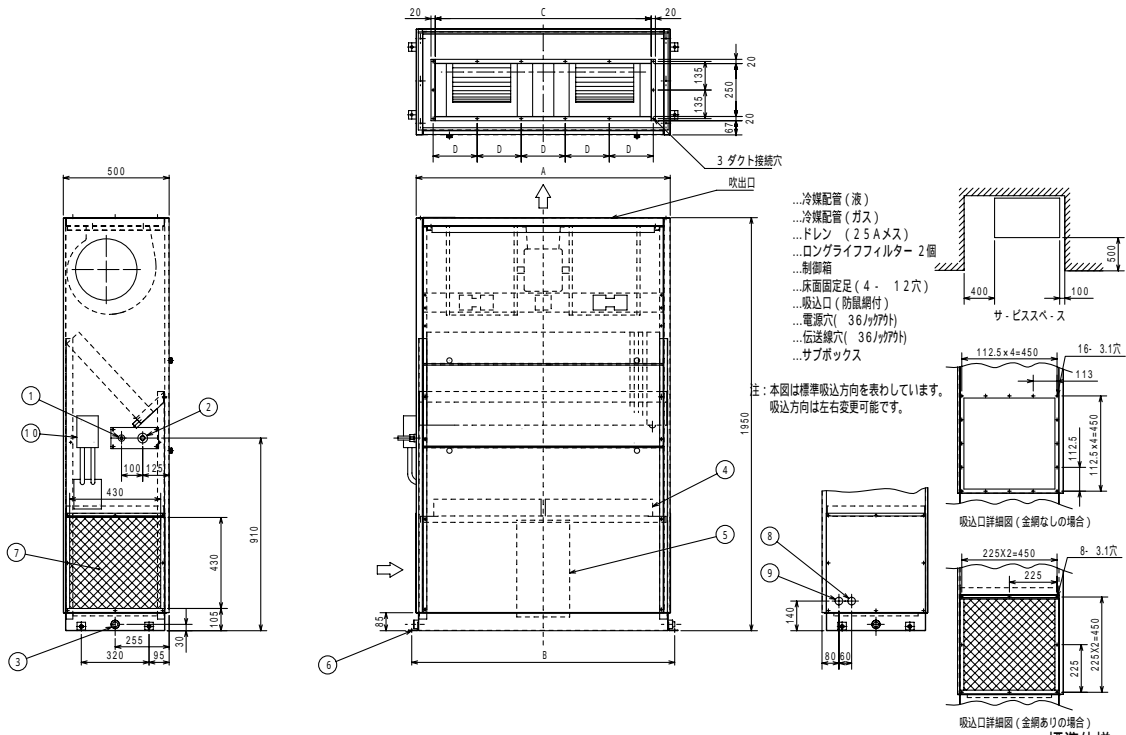

形名	A	B	C	D	冷媒配管(液)	冷媒配管(ガス)
PFFY-P112・140RM-E1	980	1022	800	164	叻付 9.52	叻付 19.05
PFFY-P224RM-E1	1200	1242	1020	208	叻付 9.52	叻付 19.05
PFFY-P280RM-E1	1440	1482	1260	256	叻付 9.52	叻付 22.2

## 床置埋込形：PFFY-LRM-E1

機種	A	B	C	D	E	F	G	H
PFFY-P28LRM-E1	886	640	572	610	360	4	12.7(本体側23HEX,フレアナット側27HEX)	6.35(本体側17HEX,フレアナット側17HEX)
PFFY-P36・45LRM-E1	1006	760	692	730	480	5	12.7(本体側23HEX,フレアナット側27HEX)	6.35(本体側17HEX,フレアナット側17HEX)
PFFY-P56LRM-E1	1246	1000	932	970	720	7	12.7(本体側26HEX,フレアナット側29HEX)	6.35(本体側19HEX,フレアナット側22HEX)
PFFY-P71LRM-E1	1246	1000	932	970	720	7	15.88(本体側26HEX,フレアナット側29HEX)	9.52(本体側19HEX,フレアナット側22HEX)

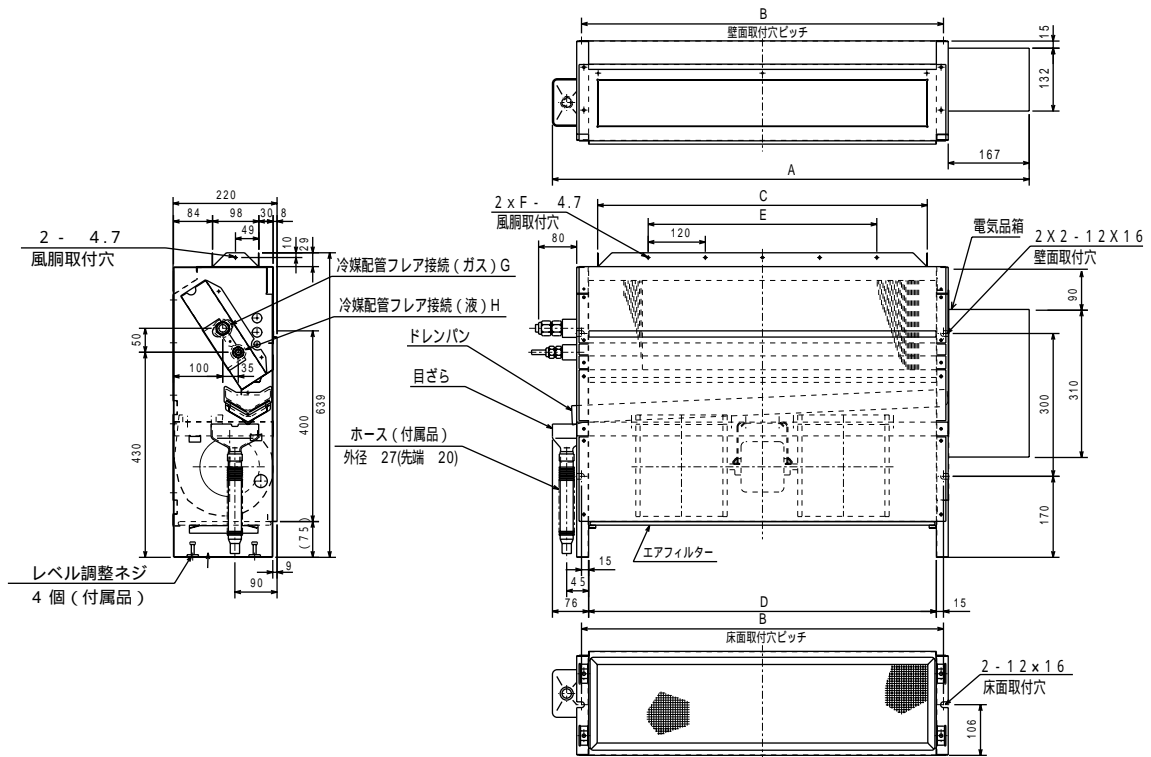

床置形 : PFFY-LEM-E1

機種	A	B	C	D	E	F
PFFY-P28LEM-E1	1050	640	600	610	12.7(本体側23HEX,フレアナット側27HEX)	6.35(本体側17HEX,フレアナット側17HEX)
PFFY-P36・45LEM-E1	1170	760	720	730	12.7(本体側23HEX,フレアナット側27HEX)	6.35(本体側17HEX,フレアナット側17HEX)
PFFY-P56LEM-E1	1410	1000	960	970	12.7(本体側26HEX,フレアナット側29HEX)	6.35(本体側19HEX,フレアナット側22HEX)
PFFY-P71LEM-E1	1410	1000	960	970	15.88(本体側26HEX,フレアナット側29HEX)	9.52(本体側19HEX,フレアナット側22HEX)

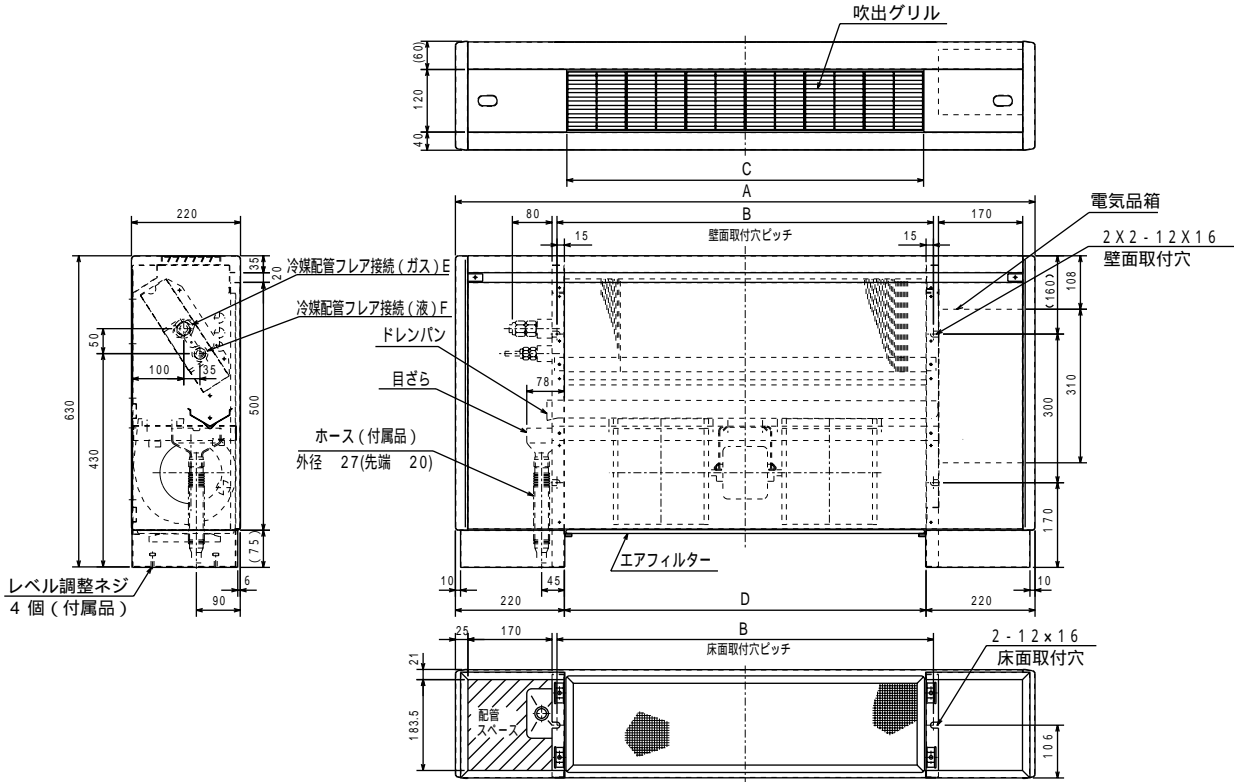

ホテル向天井埋込形 : PEFY-ML-E(-R) (受注生産品)

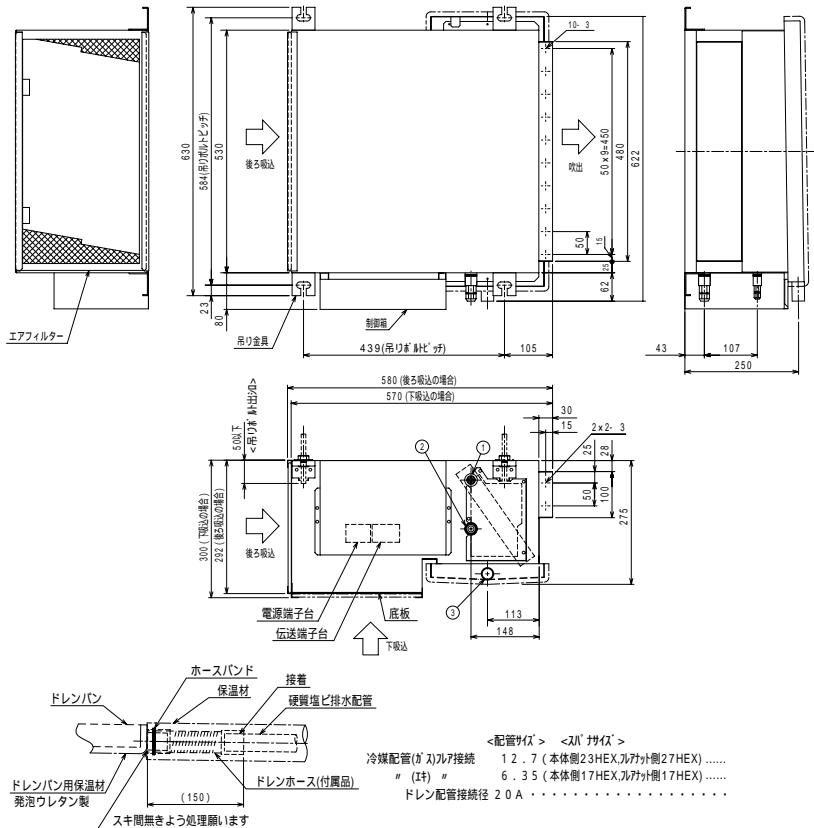

1. 吊りボルトはM10を使用してください。(現地御手配)  
また先端シロは熱交換機のメンテナンス確保に50mm以下にしてください。
2. 熱交換機の洗浄をする際には下からのメンテナンスとなりますのでサービススペースの確保と点検口を設置願います。
3. ドレンパン・制御盤は左右取付け変更可能です。
4. 本図は左配管仕様を示します。右配管仕様は本図と対称になります。  
但し電源端子台と伝送端子台の制御箱に対する位置は同一です。  
(制御箱内左: 電源端子台 / 右: 伝送端子台)  
形名 <左配管> PEFY-P22-28-36ML-E  
<右配管> PEFY-P22-28-36ML-E-R
5. 冷配管の保温保冷工事はJIS A9501に従い行ってください。
6. ドレンパンからのドレン水が溢れないよう、ドレンパンのドレン口部は定期的な清掃願います。また、ドレン配管は下り勾配となるようにしてください。
7. 後ろ吸込 / 下吸込に変更可能です。  
下吸込の場合は天井面との間に配管スペースを確保してください。

サービススペース詳細図

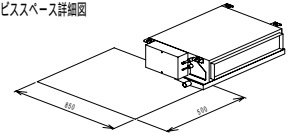

8. 吹出ダクトにグラスウールダクト(表面70シツ)を使用し、ユニットにアルミテープで固定される場合は、必ず防露処理を施してください。ユニットからの熱伝導によりダクト表面が結露し水滴を起すおそれがあります。  
防露材は下記特性の発泡ポリエチレンフォームを使用してください。  
・厚み: 5mm以上 > 挿F150mm以上  
・独立気泡性(吸水しない材質)  
・熱伝導率 0.032 < W/(m・K) 以下  
・貼付位置: 吹出口外全周(下図)

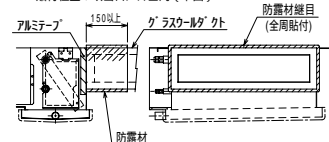

厨房用：PCFY-HM-E1

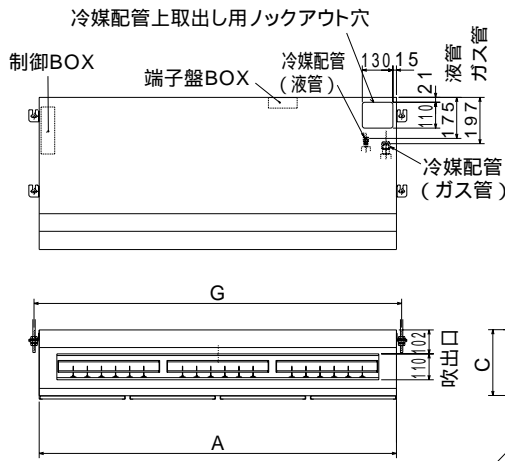

形名	P80形	P140形
本体	A	1,136
	B	650
	C	280
吊りボルト寸法	G	1,180
	H	1,564

P140形の場合

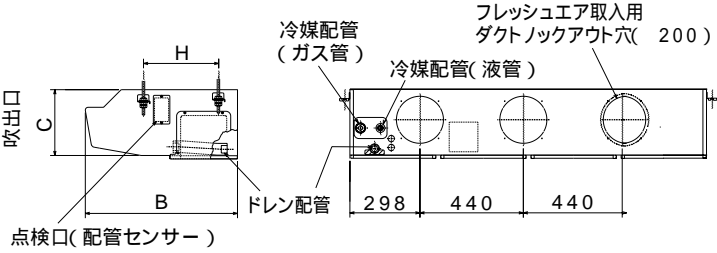

P80形の場合

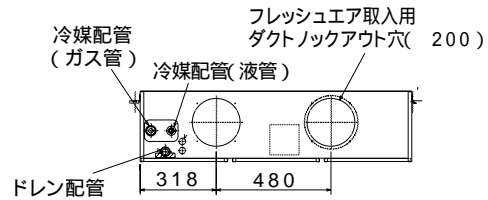

オールフレッシュ：PEFY-M-E1-F, PFFY-RM-E1-F (受注生産品)  
PEFY-P90 ~ P160M-E1-F

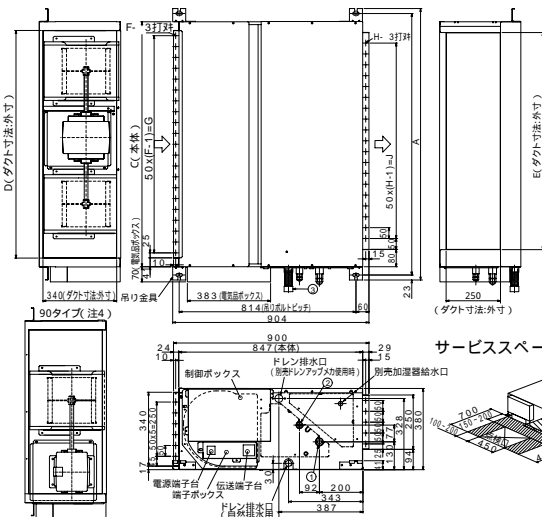

形名	A	B	C	D	E	F	G	H	J	K
PEFY-P90M-E1-F	1050	1004	930	850	800	17	800	15	700	1030
PEFY-P112・P140・P160M-E1-F	1250	1204	1130	1050	1000	21	1000	19	900	750

- 注：1.吊りボルトにはM10を使用してください。(現地御手配)  
 2.熱交換器の洗浄をする際には下からのメンテナンスとなりますのでサービススペースを確保願います。  
 3.別売の内蔵形加湿器を組込の際は、加湿エレメントのメンテナンスの為に、1ランク大きいW(600×600)点検口を設けてください。  
 (サービススペースの詳細は加湿器組込の外形図を参照ください。)  
 4.本図はファンが2つのP112・P140タイプを示します。P90タイプの場合はファンが1つとなります。  
 5.吸込側にはエアフィルター(別途御手配)を必ず使用願います。市販のエアフィルターをご使用の場合はフィルターサービスができる場所に取付けてください。  
 P90タイプ 配管サイズ スパナサイズ  
 冷媒配管(ガス)フレア接続 15.8(本体側26HEX,フレアナット側29HEX).....  
 冷媒配管(液)フレア接続 9.52(本体側19HEX,フレアナット側22HEX).....  
 P112~P160タイプ  
 冷媒配管(ガス)フレア接続 15.8(本体側29HEX,フレアナット側36HEX).....  
 冷媒配管(液)フレア接続 9.52(本体側19HEX,フレアナット側22HEX).....

ドレンホース VP-25 フレキ継手200mm(付属).....

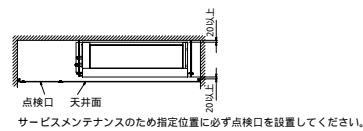

PEFY-P224・280M-E1-F

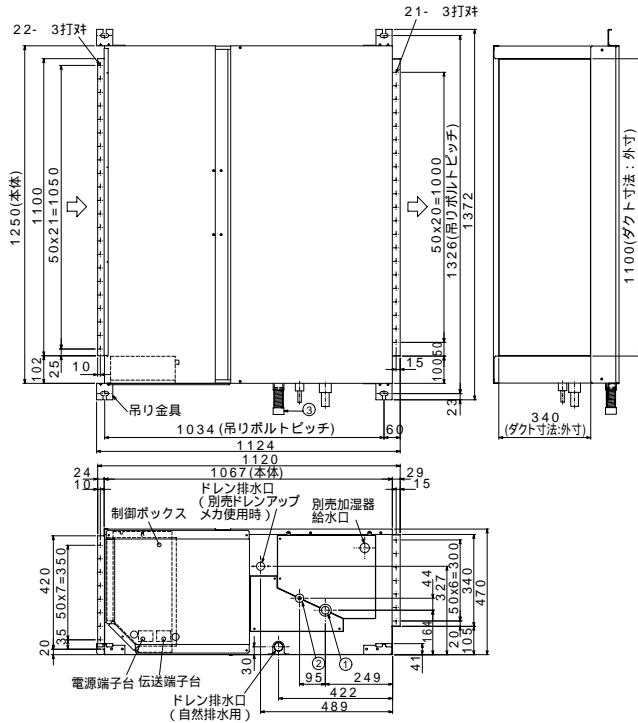

PEFY-P224M-E1-F	<配管サイズ>
冷媒配管(ガス) 口付接続	19.05.....
" (液) "	9.52.....
PEFY-P280M-E1-F	<配管サイズ>
冷媒配管(ガス) 口付接続	22.2.....
" (液) "	9.52.....
ドレン VP-25<フレキ継手200mm>(付属)...	

- 注: 1 吊りボルトにはM10を使用してください。(現地御手配)  
 2 熱交換器の洗浄をする際には下からのメンテナンスとなりますのでサービススペースを確保願います。  
 3 別売の内蔵加湿器を組込の際は、加湿エレメントのメンテナンスの点検口を設けてください。(サービススペースの詳細は加湿器組込の外形図を参照ください。)  
 4 吸込側にはエアフィルター(別売御手配)を必ず使用願います。市販のエアフィルターサービスが容易にできる場所に取付けてください。

サービススペース詳細図

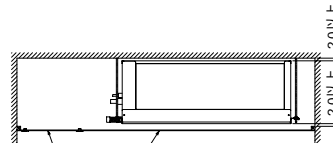
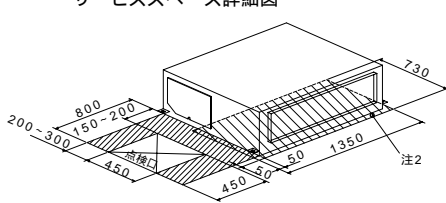

点検口 天井面  
 サービスメンテナンスのため指定位置に必ず点検口を設置してください。

PFFY-P280RM-E1-F

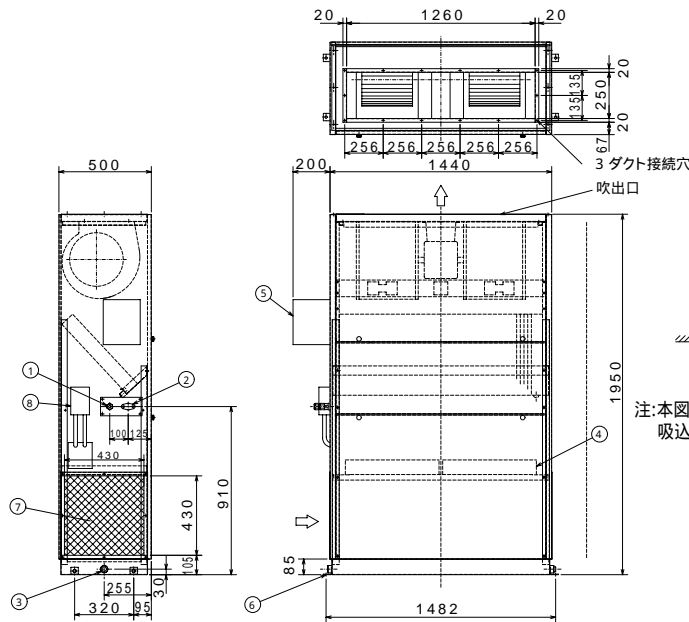

...冷媒配管<液>..... 9.52口付  
 ...冷媒配管<ガス>..... 22.2口付

注:本図は標準吸込方向を表わしています。  
 吸込方向は左右変更可能です。

- ...冷媒配管(液)
- ...冷媒配管(ガス)
- ...ドレン (25Aメス)
- ...ロングライフフィルター 2個
- ...制御箱
- ...床面固定足(4 - 12穴)
- ...吸込口(防鼠網付)
- ...サブボックス

# クリーンルーム用：PLFY-CLMD-E1（受注生産品）

- 液側配管接続口
- ガス側配管接続口
- ドレン配管接続口(自然排水時)
- ドレン配管接続口(ドレンポンプ組込仕様)
- コントロールボックス
- HEPAフィルター(別売)
- 吸込口(パンチング)
- 吹出口(拡散パンチング)
- プレフィルター
- 逆流防止ダンパ-
- 外気取入口(150ノックアウト)
- サービスパネル
- 下吸込ユニット(別売)
- 化粧パネル(下吸込用) (別売)

HEPAフィルター、下吸込ユニット、化粧パネルは別売のため現地取付となります。

形名	A	B	C	D
PLFY-P36CLMD-E1	960	840	880	930
PLFY-P45CLMD-E1	1115	995	1035	1085
PLFY-P56CLMD-E1	1420	1300	1340	1390
PLFY-P71CLMD-E1				
PLFY-P80CLMD-E1				

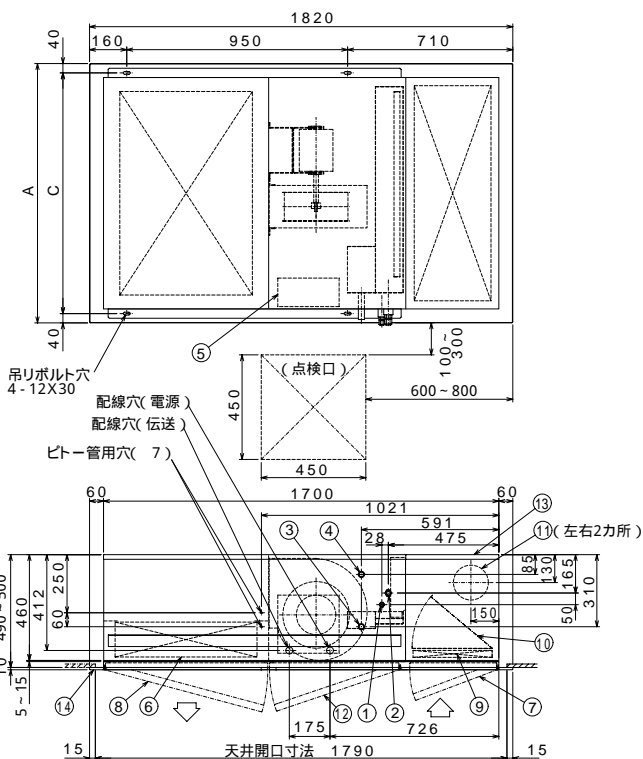
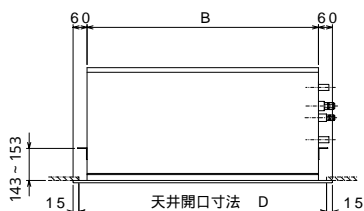



# 製品データ

## 1.冷房・暖房能力特性

### (1) システムの冷房・暖房能力の求め方

システムの冷房・暖房能力を求めるには、室外ユニットに接続された全室内ユニットの能力容量を合計し、その合計値をパラメータとして、次ページ以降の標準能力表より算出してください。

室内ユニットの能力容量

室内ユニット形番	P22形	P28形	P36形	P45形	P56形	P71形	P80形
能力容量	22	28	36	45	56	71	80

室内ユニット形番	P90形	P112形	P140形	P160形	P224形	P280形	P450形	P560形
能力容量	90	112	140	160	224	280	450	560

算出例

a. 室内・室外組合せシステム 50Hz地区

室外ユニット PUHY-P280M-E

室内ユニット PLFY-P36LMD-E1 × 2 台

PLFY-P56LMD-E1 × 4 台

b. 合計容量の算出

a項の条件より、室内ユニットの能力容量の合計値は、

能力容量の合計値 =  $36 \times 2 + 56 \times 4$

= 296

c. 標準能力表より、合計容量296の欄を見ると(50Hz地区)

室内ユニット 合計容量	能力 (kW)		入力 (kW)	
	冷房	暖房	冷房	暖房
296	28.4	31.6	7.70	7.52

標準能力表はJIS8615-1又は2の標準条件で、冷媒配管長7.5mにおける値です。

JIS8615-1又は2標準条件 冷房：室内側 乾球温度27 湿球温度19 室外側 乾球温度35

暖房：室内側 乾球温度20 室外側 乾球温度 7

湿球温度 6

したがって、運転条件が異なる場合は、次ページ以降の各種能力補正を行ってください。

d. 補正後の冷房・暖房能力の求め方

$$\text{補正後の合計能力 (kW)} = \text{標準合計能力} \times \text{能力補正係数}$$

能力補正係数とは、以下の定格条件に対する補正のことをいう。

定格条件：JIS 8615-1又は2における標準空気条件で、配管長7.5mにおけるシステム

- a. 空気条件変化による補正 [(3)- ~ -b項を参照]
- b. 冷媒配管長補正 [(3)- ~ -c項を参照]
- c. 霜取補正（暖房のみ） [(3)- ~ -d項を参照]

従って、補正後の合計能力 (kW) は以下ようになる。

$$\text{補正後の合計能力 (kW)} = \text{標準合計能力} \times (\text{空気条件による補正} \times \text{冷媒配管長補正} \times \text{霜取補正})$$

例えば、暖房における下記条件時の補正後の合計能力(kW)は以下ようになる。

<条件>

- ・標準合計暖房能力 = 31.56kW
- ・空気条件：室内吸込み空気乾球温度20、室外吸込み空気湿球温度1
- ・配管長20m（曲がり5ヶ所）

上記空気条件により、空気条件変化による補正係数は0.96 [(3)- -b項を参照]、霜取補正係数は0.83 [(3)- -d項を参照]。

上記の配管長より、冷媒配管長補正係数は0.99 [(3)- -c項を参照] (相当長 = 20m + 0.5 × 5 = 22.5m)

$$\text{よって、補正後の合計能力 (kW)} = 31.6\text{kW} \times 0.96 \times 0.83 = 25.2\text{kW}$$

## (2) 室内ユニット1台の冷房・暖房能力の求め方

室内ユニットの能力

$$\text{室内ユニットの能力 (kW)} = [(1) \cdot d\text{項で求めた能力}] \times \frac{\text{求めたい室内ユニットの定格能力}}{\text{室内ユニットの定格能力の合計値}}$$

算出例

上記(1)・a項の組合せシステムで、JIS B 8615-1又は8615-2の標準条件で冷媒配管長20mとすると(曲がり5ヶ所)

### a. 冷房能力の場合

冷媒配管長補正係数は	相当長 = 22.5(m) より0.97となる。
補正後の合計能力は	$28.4 \times 0.97 = 27.5 \text{ (kW)}$
室内ユニットの定格能力の合計値は、	29.6 (kW)
上記(2) 項の式より室内ユニットの能力は	$P36\text{形} = 27.5 \times \frac{36}{296} = 3.3 \text{ (kW)}$
	$P56\text{形} = 27.5 \times \frac{56}{296} = 5.2 \text{ (kW)}$

### b. 暖房能力の場合

冷媒配管長補正係数は	相当長 = 22.5(m) より0.99となる。
補正後の合計能力は	$31.6 \times 0.99 = 31.3 \text{ (kW)}$
室内ユニットの定格能力の合計値は、	33.2 (kW)
上記(2) 項の式より室内ユニットの能力は	$P36\text{形} = 31.3 \times \frac{40}{332} = 3.8 \text{ (kW)}$
	$P56\text{形} = 31.3 \times \frac{63}{332} = 5.9 \text{ (kW)}$

(3)標準能力表および能力補正

P140～P280M-E形

a. 標準能力表

【PUHY-P140M-E】

室内ユニット 合計容量	能力 (kW)		入力 (kW)	
	冷房	暖房	冷房	暖房
71	7.1	8.0	1.93	2.47
72	7.2	8.0	1.96	2.50
73	7.3	8.2	1.99	2.52
78	7.8	8.8	2.12	2.64
80	8.0	9.0	2.17	2.69
81	8.1	9.0	2.20	2.71
84	8.4	9.5	2.28	2.78
86	8.6	9.7	2.34	2.83
88	8.8	10.0	2.39	2.88
89	8.9	10.0	2.42	2.90
90	9.0	10.0	2.45	2.92
92	9.2	10.3	2.50	2.97
93	9.3	10.5	2.53	2.99
94	9.4	10.5	2.56	3.01
95	9.5	10.7	2.59	3.04
99	9.9	11.2	2.70	3.13
100	10.0	11.2	2.73	3.15
101	10.1	11.3	2.76	3.17
102	10.2	11.5	2.79	3.20
103	10.3	11.5	2.82	3.22
106	10.6	12.0	2.90	3.29
107	10.7	12.0	2.93	3.31
108	10.8	12.0	2.96	3.33
109	10.9	12.2	2.99	3.35
110	11.0	12.5	3.02	3.38
111	11.1	12.5	3.04	3.40
112	11.2	12.5	3.07	3.42
114	11.4	12.8	3.13	3.47
115	11.5	13.0	3.16	3.49
116	11.6	13.0	3.19	3.51
117	11.7	13.0	3.22	3.54
118	11.8	13.2	3.24	3.56
120	12.0	13.5	3.30	3.60
121	12.1	13.7	3.33	3.63
122	12.2	13.7	3.36	3.65
123	12.3	13.8	3.39	3.67
124	12.4	14.0	3.42	3.69
125	12.5	14.0	3.45	3.72
126	12.6	14.0	3.47	3.74
127	12.7	14.3	3.50	3.76
128	12.8	14.3	3.53	3.78
129	12.9	14.5	3.56	3.81
130	13.0	14.5	3.59	3.83
131	13.1	14.7	3.62	3.85
132	13.2	15.0	3.64	3.88
133	13.3	15.0	3.67	3.90
134	13.4	15.0	3.70	3.92
135	13.5	15.0	3.73	3.94
136	13.6	15.2	3.76	3.97
137	13.7	15.3	3.79	3.99
138	13.8	15.5	3.81	4.01
139	13.9	15.5	3.84	4.04
140	14.0	16.0	3.87	4.06
142	14.1	16.0	3.87	4.05
143	14.1	16.0	3.87	4.04
144	14.1	16.0	3.87	4.03
145	14.1	16.0	3.87	4.03
146	14.2	16.0	3.87	4.02
147	14.2	16.0	3.87	4.01
148	14.2	16.0	3.87	4.01
149	14.2	16.0	3.88	4.00
150	14.3	16.1	3.88	4.00
151	14.3	16.1	3.88	3.99
152	14.3	16.1	3.88	3.98
153	14.3	16.1	3.88	3.98
154	14.4	16.1	3.88	3.97
155	14.4	16.1	3.88	3.96
156	14.4	16.1	3.88	3.96
157	14.4	16.1	3.88	3.95
158	14.5	16.1	3.88	3.94

室内ユニット 合計容量	能力 (kW)		入力 (kW)	
	冷房	暖房	冷房	暖房
159	14.5	16.1	3.88	3.94
160	14.5	16.1	3.88	3.93
161	14.5	16.1	3.88	3.92
162	14.6	16.1	3.88	3.92
163	14.6	16.1	3.88	3.91
164	14.6	16.1	3.88	3.90
165	14.6	16.1	3.89	3.90
166	14.7	16.1	3.89	3.89
167	14.7	16.1	3.89	3.89
168	14.7	16.1	3.89	3.88
169	14.7	16.2	3.89	3.87
170	14.8	16.2	3.89	3.87
171	14.8	16.2	3.89	3.86
172	14.8	16.2	3.89	3.85
173	14.8	16.2	3.89	3.85
174	14.9	16.2	3.89	3.84
175	14.9	16.2	3.89	3.83
176	14.9	16.2	3.89	3.83
177	14.9	16.2	3.89	3.82
178	15.0	16.2	3.89	3.81
179	15.0	16.2	3.89	3.81
180	15.0	16.2	3.89	3.80
181	15.0	16.2	3.90	3.79
182	15.1	16.2	3.90	3.79

## 【PUHY-P160M-E】

室内ユニット 合計容量	能力 (kW)		入力 (kW)	
	冷房	暖房	冷房	暖房
80	8.0	9.0	2.28	2.45
81	8.1	9.0	2.32	2.48
84	8.4	9.5	2.42	2.56
86	8.6	9.7	2.48	2.62
88	8.8	10.0	2.55	2.67
89	8.9	10.0	2.58	2.70
90	9.0	10.0	2.62	2.73
92	9.2	10.3	2.68	2.79
93	9.3	10.5	2.72	2.82
94	9.4	10.5	2.75	2.84
95	9.5	10.7	2.79	2.87
99	9.9	11.2	2.93	2.99
100	10.0	11.2	2.96	3.01
101	10.1	11.3	3.00	3.04
102	10.2	11.5	3.03	3.07
103	10.3	11.5	3.07	3.10
106	10.6	12.0	3.17	3.19
107	10.7	12.0	3.21	3.22
108	10.8	12.0	3.24	3.24
109	10.9	12.2	3.28	3.27
110	11.0	12.5	3.31	3.30
111	11.1	12.5	3.35	3.33
112	11.2	12.5	3.38	3.36
114	11.4	12.8	3.45	3.42
115	11.5	13.0	3.49	3.45
116	11.6	13.0	3.52	3.48
117	11.7	13.0	3.55	3.51
118	11.8	13.2	3.59	3.53
120	12.0	13.5	3.66	3.59
121	12.1	13.7	3.69	3.62
122	12.2	13.7	3.73	3.65
123	12.3	13.8	3.76	3.68
124	12.4	14.0	3.79	3.71
125	12.5	14.0	3.83	3.74
126	12.6	14.0	3.86	3.77
127	12.7	14.3	3.89	3.80
128	12.8	14.3	3.92	3.83
129	12.9	14.5	3.96	3.86
130	13.0	14.5	3.99	3.89
131	13.1	14.7	4.02	3.91
132	13.2	15.0	4.05	3.94
133	13.3	15.0	4.09	3.97
134	13.4	15.0	4.12	4.00
135	13.5	15.0	4.15	4.03
136	13.6	15.2	4.18	4.06
137	13.7	15.3	4.21	4.09
138	13.8	15.5	4.24	4.12
139	13.9	15.5	4.27	4.15
140	14.0	15.7	4.30	4.18
142	14.2	16.0	4.36	4.23
143	14.3	16.0	4.39	4.26
144	14.4	16.0	4.42	4.29
145	14.5	16.2	4.44	4.32
146	14.6	16.3	4.47	4.35
147	14.7	16.5	4.50	4.38
148	14.8	16.5	4.53	4.41
149	14.9	16.8	4.55	4.44
150	15.0	16.8	4.58	4.47
151	15.1	17.0	4.61	4.49
152	15.2	17.0	4.63	4.52
153	15.3	17.0	4.66	4.55
154	15.4	17.2	4.68	4.58
155	15.5	17.5	4.71	4.61
156	15.6	17.5	4.73	4.64
157	15.7	17.5	4.75	4.67
158	15.8	17.7	4.78	4.69
159	15.9	17.8	4.80	4.72
160	16.0	18.0	4.82	4.75
161	16.0	18.0	4.82	4.74
162	16.1	18.0	4.82	4.73

室内ユニット 合計容量	能力 (kW)		入力 (kW)	
	冷房	暖房	冷房	暖房
163	16.1	18.0	4.82	4.72
164	16.1	18.0	4.82	4.71
165	16.1	18.0	4.82	4.71
166	16.2	18.0	4.82	4.70
167	16.2	18.0	4.82	4.69
168	16.2	18.0	4.82	4.68
169	16.2	18.0	4.82	4.67
170	16.3	18.1	4.82	4.66
171	16.3	18.1	4.82	4.65
172	16.3	18.1	4.82	4.64
173	16.3	18.1	4.82	4.64
174	16.4	18.1	4.82	4.63
175	16.4	18.1	4.82	4.62
176	16.4	18.1	4.82	4.61
177	16.4	18.1	4.83	4.60
178	16.5	18.1	4.83	4.59
179	16.5	18.1	4.83	4.58
180	16.5	18.1	4.83	4.57
181	16.5	18.1	4.83	4.56
182	16.6	18.1	4.83	4.56
183	16.6	18.1	4.83	4.55
184	16.6	18.1	4.83	4.54
185	16.6	18.1	4.83	4.53
186	16.7	18.1	4.83	4.52
187	16.7	18.1	4.83	4.51
188	16.7	18.1	4.83	4.50
189	16.7	18.2	4.83	4.49
190	16.8	18.2	4.83	4.48
191	16.8	18.2	4.83	4.48
192	16.8	18.2	4.83	4.47
193	16.8	18.2	4.83	4.46
194	16.9	18.2	4.83	4.45
195	16.9	18.2	4.83	4.44
196	16.9	18.2	4.83	4.43
197	16.9	18.2	4.83	4.42
198	17.0	18.2	4.83	4.41
199	17.0	18.2	4.83	4.41
200	17.0	18.2	4.83	4.40
201	17.0	18.2	4.83	4.39
202	17.1	18.2	4.83	4.38
203	17.1	18.2	4.83	4.37
204	17.1	18.2	4.83	4.36
205	17.1	18.2	4.83	4.35
206	17.2	18.2	4.84	4.34
207	17.2	18.3	4.84	4.33
208	17.2	18.3	4.84	4.33

【PUHY-P224M-E】

室内ユニット 合計容量	能力 (kW)		入力 (kW)	
	冷房	暖房	冷房	暖房
112	11.2	12.5	2.92	3.26
114	11.4	12.8	2.98	3.31
115	11.5	13.0	3.01	3.33
116	11.6	13.0	3.04	3.35
117	11.7	13.0	3.07	3.37
118	11.8	13.2	3.09	3.40
120	12.0	13.5	3.15	3.44
121	12.1	13.7	3.18	3.46
122	12.2	13.7	3.21	3.49
123	12.3	13.8	3.24	3.51
124	12.4	14.0	3.26	3.53
125	12.5	14.0	3.29	3.55
126	12.6	14.0	3.32	3.57
127	12.7	14.3	3.35	3.60
128	12.8	14.3	3.38	3.62
129	12.9	14.5	3.40	3.64
130	13.0	14.5	3.43	3.66
131	13.1	14.7	3.46	3.69
132	13.2	15.0	3.49	3.71
133	13.3	15.0	3.52	3.73
134	13.4	15.0	3.55	3.75
135	13.5	15.0	3.57	3.77
136	13.6	15.2	3.60	3.80
137	13.7	15.3	3.63	3.82
138	13.8	15.5	3.66	3.84
139	13.9	15.5	3.69	3.86
140	14.0	15.7	3.72	3.89
142	14.2	16.0	3.77	3.93
143	14.3	16.0	3.80	3.95
144	14.4	16.0	3.83	3.98
145	14.5	16.2	3.86	4.00
146	14.6	16.3	3.89	4.02
147	14.7	16.5	3.92	4.04
148	14.8	16.5	3.94	4.07
149	14.9	16.8	3.97	4.09
150	15.0	16.8	4.00	4.11
151	15.1	17.0	4.03	4.13
152	15.2	17.0	4.06	4.16
153	15.3	17.0	4.09	4.18
154	15.4	17.2	4.11	4.20
155	15.5	17.5	4.14	4.22
156	15.6	17.5	4.17	4.25
157	15.7	17.5	4.20	4.27
158	15.8	17.7	4.23	4.29
159	15.9	17.8	4.26	4.31
160	16.0	18.0	4.29	4.34
161	16.1	18.0	4.31	4.36
162	16.2	18.0	4.34	4.38
163	16.3	18.2	4.37	4.41
164	16.4	18.3	4.40	4.43
165	16.5	18.5	4.43	4.45
166	16.6	18.5	4.46	4.48
167	16.7	18.7	4.49	4.50
168	16.8	18.8	4.51	4.52
169	16.9	19.0	4.54	4.55
170	17.0	19.0	4.57	4.57
171	17.1	19.0	4.60	4.59
172	17.2	19.2	4.63	4.62
173	17.3	19.3	4.66	4.64
174	17.4	19.5	4.69	4.66
175	17.5	19.5	4.72	4.69
176	17.6	19.7	4.74	4.71
177	17.7	20.0	4.77	4.74
178	17.8	20.0	4.80	4.76
179	17.9	20.0	4.83	4.78
180	18.0	20.0	4.86	4.81
181	18.1	20.2	4.89	4.83
182	18.2	20.3	4.92	4.86
183	18.3	20.5	4.95	4.88
184	18.4	20.5	4.97	4.91

室内ユニット 合計容量	能力 (kW)		入力 (kW)	
	冷房	暖房	冷房	暖房
185	18.5	20.7	5.00	4.93
186	18.6	20.8	5.03	4.96
187	18.7	21.0	5.06	4.98
188	18.8	21.0	5.09	5.01
189	18.9	21.0	5.12	5.03
190	19.0	21.2	5.15	5.06
191	19.1	21.3	5.18	5.08
192	19.2	21.5	5.21	5.11
193	19.3	21.5	5.23	5.13
194	19.4	21.7	5.26	5.16
195	19.5	21.8	5.29	5.18
196	19.6	22.0	5.32	5.21
197	19.7	22.0	5.35	5.24
198	19.8	22.0	5.38	5.26
199	19.9	22.2	5.41	5.29
200	20.0	22.3	5.44	5.31
201	20.1	22.5	5.47	5.34
202	20.2	22.5	5.50	5.37
203	20.3	22.7	5.53	5.39
204	20.4	22.8	5.55	5.42
205	20.5	23.0	5.58	5.45
206	20.6	23.0	5.61	5.47
207	20.7	23.0	5.64	5.50
208	20.8	23.2	5.67	5.53
209	20.9	23.3	5.70	5.55
210	21.0	23.5	5.73	5.58
211	21.1	23.5	5.76	5.61
212	21.2	23.7	5.79	5.64
213	21.3	23.8	5.82	5.66
214	21.4	24.0	5.85	5.69
215	21.5	24.0	5.88	5.72
216	21.6	24.0	5.90	5.75
217	21.7	24.2	5.93	5.78
218	21.8	24.3	5.96	5.81
219	21.9	24.5	5.99	5.83
220	22.0	24.5	6.02	5.86
221	22.1	24.7	6.05	5.89
222	22.2	24.8	6.08	5.92
223	22.3	25.0	6.11	5.95
224	22.4	25.0	6.14	5.98
225	22.4	25.0	6.14	5.97
226	22.5	25.0	6.14	5.97
227	22.5	25.0	6.14	5.96
228	22.5	25.0	6.13	5.95
229	22.5	25.0	6.13	5.95
230	22.6	25.0	6.13	5.94
231	22.6	25.0	6.13	5.94
232	22.6	25.0	6.13	5.93
233	22.6	25.0	6.13	5.92
234	22.7	25.1	6.13	5.92
235	22.7	25.1	6.13	5.91
236	22.7	25.1	6.12	5.90
237	22.7	25.1	6.12	5.90
238	22.8	25.1	6.12	5.89
239	22.8	25.1	6.12	5.88
240	22.8	25.1	6.12	5.88
241	22.8	25.1	6.12	5.87
242	22.9	25.1	6.12	5.87
243	22.9	25.1	6.11	5.86
244	22.9	25.1	6.11	5.85
245	22.9	25.1	6.11	5.85
246	23.0	25.1	6.11	5.84
247	23.0	25.1	6.11	5.83
248	23.0	25.1	6.11	5.83
249	23.0	25.1	6.11	5.82
250	23.1	25.1	6.11	5.81
251	23.1	25.1	6.10	5.81
252	23.1	25.1	6.10	5.80
253	23.1	25.2	6.10	5.80
254	23.2	25.2	6.10	5.79

室内ユニット 合計容量	能力 (kW)		入力 (kW)	
	冷房	暖房	冷房	暖房
255	23.2	25.2	6.10	5.78
256	23.2	25.2	6.10	5.78
257	23.2	25.2	6.10	5.77
258	23.3	25.2	6.09	5.76
259	23.3	25.2	6.09	5.76
260	23.3	25.2	6.09	5.75
261	23.3	25.2	6.09	5.74
262	23.4	25.2	6.09	5.74
263	23.4	25.2	6.09	5.73
264	23.4	25.2	6.09	5.73
265	23.4	25.2	6.08	5.72
266	23.5	25.2	6.08	5.71
267	23.5	25.2	6.08	5.71
268	23.5	25.2	6.08	5.70
269	23.5	25.2	6.08	5.69
270	23.6	25.2	6.08	5.69
271	23.6	25.3	6.08	5.68
272	23.6	25.3	6.08	5.67
273	23.6	25.3	6.07	5.67
274	23.7	25.3	6.07	5.66
275	23.7	25.3	6.07	5.66
276	23.7	25.3	6.07	5.65
277	23.7	25.3	6.07	5.64
278	23.8	25.3	6.07	5.64
279	23.8	25.3	6.07	5.63
280	23.8	25.3	6.06	5.62
281	23.8	25.3	6.06	5.62
282	23.9	25.3	6.06	5.61
283	23.9	25.3	6.06	5.60
284	23.9	25.3	6.06	5.60
285	23.9	25.3	6.06	5.59
286	24.0	25.3	6.06	5.59
287	24.0	25.3	6.06	5.58
288	24.0	25.3	6.05	5.57
289	24.0	25.3	6.05	5.57
290	24.1	25.4	6.05	5.56
291	24.1	25.4	6.05	5.55

【PUHY-P280M-E】

室内ユニット 合計容量	能力 (kW)		入力 (kW)	
	冷房	暖房	冷房	暖房
140	14.0	15.7	3.45	4.01
142	14.2	16.0	3.50	4.06
143	14.3	16.0	3.52	4.08
144	14.4	16.0	3.54	4.11
145	14.5	16.2	3.57	4.13
146	14.6	16.3	3.59	4.16
147	14.7	16.5	3.61	4.18
148	14.8	16.5	3.63	4.20
149	14.9	16.8	3.66	4.23
150	15.0	16.8	3.68	4.25
151	15.1	17.0	3.70	4.28
152	15.2	17.0	3.72	4.30
153	15.3	17.0	3.75	4.32
154	15.4	17.2	3.77	4.35
155	15.5	17.5	3.79	4.37
156	15.6	17.5	3.82	4.40
157	15.7	17.5	3.84	4.42
158	15.8	17.7	3.86	4.44
159	15.9	17.8	3.89	4.47
160	16.0	18.0	3.91	4.49
161	16.1	18.0	3.93	4.52
162	16.2	18.0	3.96	4.54
163	16.3	18.2	3.98	4.56
164	16.4	18.3	4.00	4.59
165	16.5	18.5	4.03	4.61
166	16.6	18.5	4.05	4.64
167	16.7	18.7	4.08	4.66
168	16.8	18.8	4.10	4.68
169	16.9	19.0	4.12	4.71
170	17.0	19.0	4.15	4.73
171	17.1	19.0	4.17	4.76
172	17.2	19.2	4.20	4.78
173	17.3	19.3	4.22	4.81
174	17.4	19.5	4.25	4.83
175	17.5	19.5	4.27	4.85
176	17.6	19.7	4.30	4.88
177	17.7	20.0	4.32	4.90
178	17.8	20.0	4.34	4.93
179	17.9	20.0	4.37	4.95
180	18.0	20.0	4.39	4.98
181	18.1	20.2	4.42	5.00
182	18.2	20.3	4.45	5.02
183	18.3	20.5	4.47	5.05
184	18.4	20.5	4.50	5.07
185	18.5	20.7	4.52	5.10
186	18.6	20.8	4.55	5.12
187	18.7	21.0	4.57	5.15
188	18.8	21.0	4.60	5.17
189	18.9	21.0	4.63	5.20
190	19.0	21.2	4.65	5.22
191	19.1	21.3	4.68	5.24
192	19.2	21.5	4.70	5.27
193	19.3	21.5	4.73	5.29
194	19.4	21.7	4.76	5.32
195	19.5	21.8	4.79	5.34
196	19.6	22.0	4.81	5.37
197	19.7	22.0	4.84	5.39
198	19.8	22.0	4.87	5.42
199	19.9	22.2	4.89	5.44
200	20.0	22.3	4.92	5.47
201	20.1	22.5	4.95	5.49
202	20.2	22.5	4.98	5.52
203	20.3	22.7	5.00	5.54
204	20.4	22.8	5.03	5.57
205	20.5	23.0	5.06	5.59
206	20.6	23.0	5.09	5.62
207	20.7	23.0	5.12	5.64
208	20.8	23.2	5.15	5.67
209	20.9	23.3	5.18	5.69
210	21.0	23.5	5.20	5.72

室内ユニット 合計容量	能力 (kW)		入力 (kW)	
	冷房	暖房	冷房	暖房
211	21.1	23.5	5.23	5.74
212	21.2	23.7	5.26	5.77
213	21.3	23.8	5.29	5.79
214	21.4	24.0	5.32	5.82
215	21.5	24.0	5.35	5.84
216	21.6	24.0	5.38	5.87
217	21.7	24.2	5.41	5.90
218	21.8	24.3	5.44	5.92
219	21.9	24.5	5.47	5.95
220	22.0	24.5	5.50	5.97
221	22.1	24.7	5.53	6.00
222	22.2	24.8	5.56	6.02
223	22.3	25.0	5.60	6.05
224	22.4	25.0	5.63	6.08
225	22.5	25.0	5.66	6.10
226	22.6	25.2	5.69	6.13
227	22.7	25.3	5.72	6.15
228	22.8	25.5	5.75	6.18
229	22.9	25.5	5.79	6.21
230	23.0	25.7	5.82	6.23
231	23.1	25.8	5.85	6.26
232	23.2	26.0	5.88	6.28
233	23.3	26.0	5.92	6.31
234	23.4	26.0	5.95	6.34
235	23.5	26.2	5.98	6.36
236	23.6	26.3	6.02	6.39
237	23.7	26.5	6.05	6.42
238	23.8	26.5	6.09	6.44
239	23.9	26.7	6.12	6.47
240	24.0	26.8	6.15	6.50
241	24.1	27.0	6.19	6.52
242	24.2	27.0	6.22	6.55
243	24.3	27.0	6.26	6.58
244	24.4	27.2	6.29	6.60
245	24.5	27.3	6.33	6.63
246	24.6	27.5	6.36	6.66
247	24.7	27.5	6.40	6.69
248	24.8	27.7	6.44	6.71
249	24.9	27.8	6.47	6.74
250	25.0	28.0	6.51	6.77
251	25.1	28.0	6.55	6.79
252	25.2	28.0	6.58	6.82
253	25.3	28.2	6.62	6.85
254	25.4	28.3	6.66	6.88
255	25.5	28.5	6.70	6.91
256	25.6	28.5	6.73	6.93
257	25.7	28.7	6.77	6.96
258	25.8	28.8	6.81	6.99
259	25.9	29.0	6.85	7.02
260	26.0	29.0	6.89	7.04
261	26.1	29.0	6.93	7.07
262	26.2	29.2	6.97	7.10
263	26.3	29.3	7.01	7.13
264	26.4	29.5	7.05	7.16
265	26.5	29.5	7.09	7.19
266	26.6	29.7	7.13	7.21
267	26.7	29.8	7.17	7.24
268	26.8	30.0	7.21	7.27
269	26.9	30.0	7.25	7.30
270	27.0	30.0	7.29	7.33
271	27.1	30.2	7.33	7.36
272	27.2	30.3	7.37	7.39
273	27.3	30.5	7.42	7.42
274	27.4	30.5	7.46	7.44
275	27.5	30.7	7.50	7.47
276	27.6	30.8	7.54	7.50
277	27.7	31.0	7.59	7.53
278	27.8	31.0	7.63	7.56
279	27.9	31.0	7.68	7.59
280	28.0	31.5	7.72	7.62

室内ユニット 合計容量	能力 (kW)		入力 (kW)	
	冷房	暖房	冷房	暖房
281	28.0	31.5	7.72	7.61
282	28.0	31.5	7.72	7.61
283	28.1	31.5	7.72	7.60
284	28.1	31.5	7.72	7.59
285	28.1	31.5	7.72	7.59
286	28.1	31.5	7.71	7.58
287	28.2	31.5	7.71	7.58
288	28.2	31.5	7.71	7.57
289	28.2	31.5	7.71	7.56
290	28.2	31.5	7.71	7.56
291	28.3	31.5	7.71	7.55
292	28.3	31.5	7.71	7.54
293	28.3	31.6	7.71	7.54
294	28.3	31.6	7.71	7.53
295	28.4	31.6	7.71	7.52
296	28.4	31.6	7.70	7.52
297	28.4	31.6	7.70	7.51
298	28.4	31.6	7.70	7.51
299	28.5	31.6	7.70	7.50
300	28.5	31.6	7.70	7.49
301	28.5	31.6	7.70	7.49
302	28.5	31.6	7.70	7.48
303	28.6	31.6	7.70	7.47
304	28.6	31.6	7.70	7.47
305	28.6	31.6	7.70	7.46
306	28.6	31.6	7.70	7.45
307	28.7	31.6	7.69	7.45
308	28.7	31.6	7.69	7.44
309	28.7	31.6	7.69	7.43
310	28.7	31.6	7.69	7.43
311	28.8	31.6	7.69	7.42
312	28.8	31.6	7.69	7.42
313	28.8	31.6	7.69	7.41
314	28.8	31.6	7.69	7.40
315	28.9	31.6	7.69	7.40
316	28.9	31.6	7.69	7.39
317	28.9	31.7	7.68	7.38
318	28.9	31.7	7.68	7.38
319	29.0	31.7	7.68	7.37
320	29.0	31.7	7.68	7.36
321	29.0	31.7	7.68	7.36
322	29.0	31.7	7.68	7.35
323	29.0	31.7	7.68	7.35
324	29.1	31.7	7.68	7.34
325	29.1	31.7	7.68	7.33
326	29.1	31.7	7.68	7.33
327	29.1	31.7	7.67	7.32
328	29.2	31.7	7.67	7.31
329	29.2	31.7	7.67	7.31
330	29.2	31.7	7.67	7.30
331	29.2	31.7	7.67	7.29
332	29.3	31.7	7.67	7.29
333	29.3	31.7	7.67	7.28
334	29.3	31.7	7.67	7.27
335	29.3	31.7	7.67	7.27
336	29.4	31.7	7.67	7.26
337	29.4	31.7	7.67	7.26
338	29.4	31.7	7.66	7.25
339	29.4	31.7	7.66	7.24
340	29.5	31.7	7.66	7.24
341	29.5	31.8	7.66	7.23
342	29.5	31.8	7.66	7.22
343	29.5	31.8	7.66	7.22
344	29.6	31.8	7.66	7.21
345	29.6	31.8	7.66	7.20
346	29.6	31.8	7.66	7.20
347	29.6	31.8	7.66	7.19
348	29.7	31.8	7.65	7.19
349	29.7	31.8	7.65	7.18
350	29.7	31.8	7.65	7.17

### 【PUHY-P280M-E】

室内ユニット 合計容量	能力 (kW)		入力 (kW)	
	冷房	暖房	冷房	暖房
351	29.7	31.8	7.65	7.17
352	29.8	31.8	7.65	7.16
353	29.8	31.8	7.65	7.15
354	29.8	31.8	7.65	7.15
355	29.8	31.8	7.65	7.14
356	29.9	31.8	7.65	7.13
357	29.9	31.8	7.65	7.13
358	29.9	31.8	7.64	7.12
359	29.9	31.8	7.64	7.11
360	30.0	31.8	7.64	7.11
361	30.0	31.8	7.64	7.10
362	30.0	31.8	7.64	7.10
363	30.0	31.8	7.64	7.09
364	30.0	31.8	7.64	7.08

b. 空気条件変化による補正

【PUHY-P140・P160M-E】

・冷房能力・入力補正

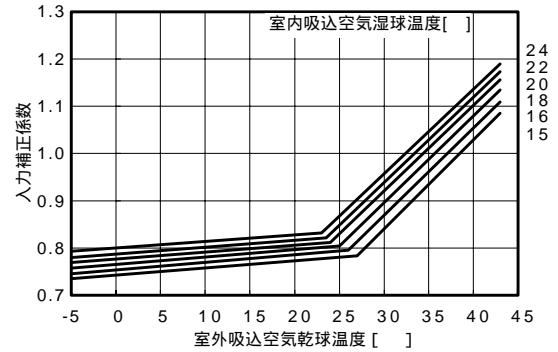
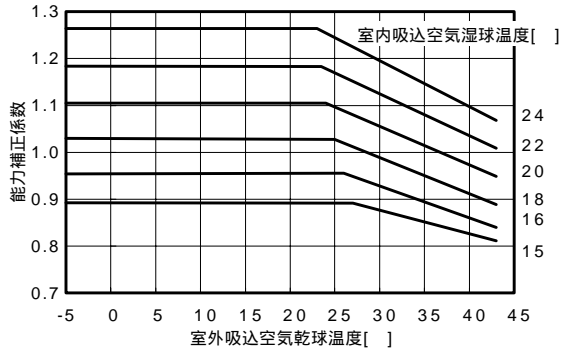

・暖房能力・入力補正

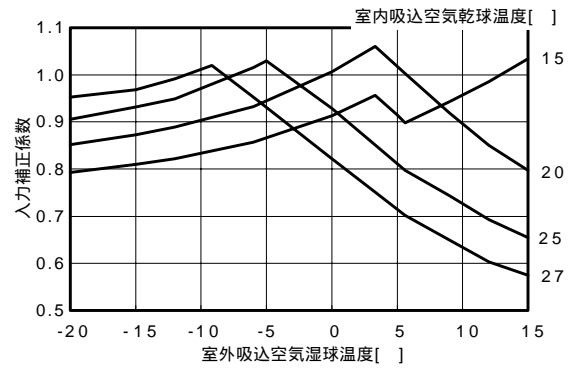
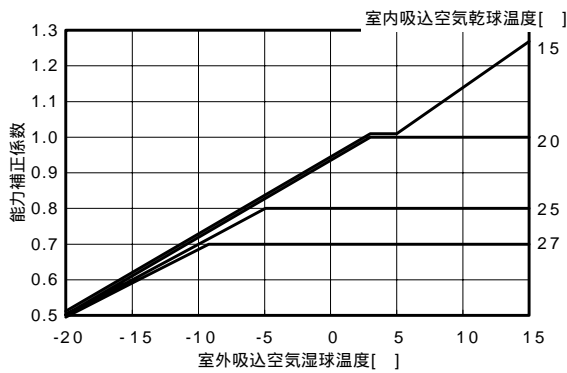

・冷房能力・入力補正 (オールフレッシュ)

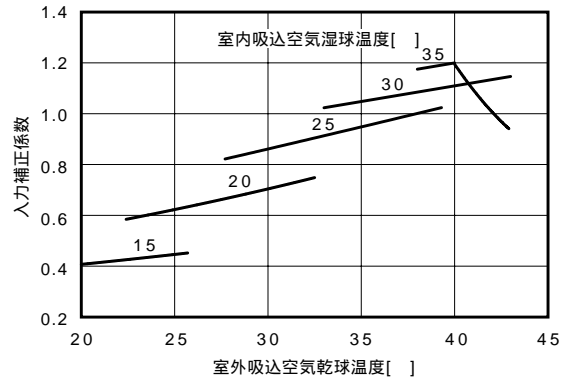
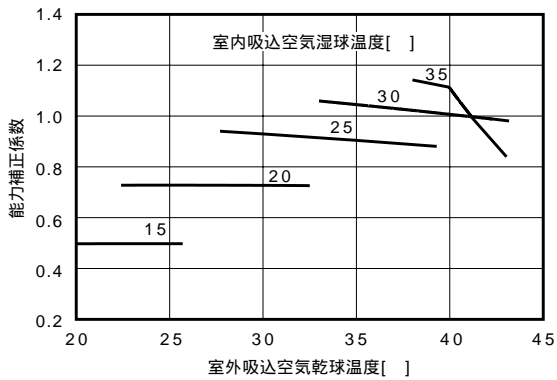

・暖房能力・入力補正 (オールフレッシュ)

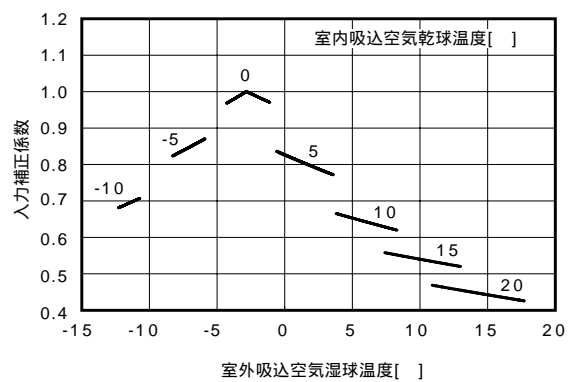
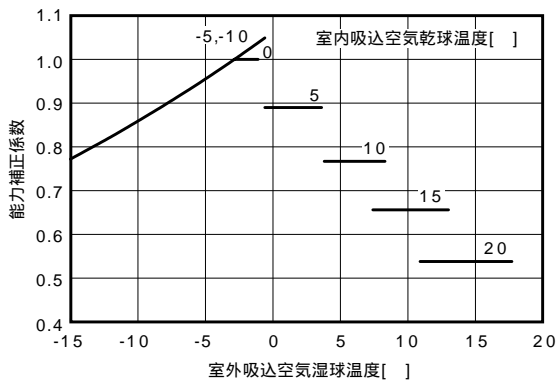



【PUHY-P224・P280M-E】

・冷房能力・入力補正

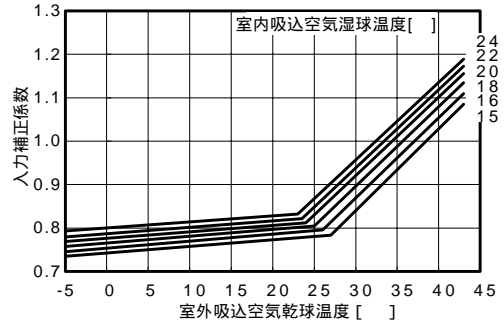
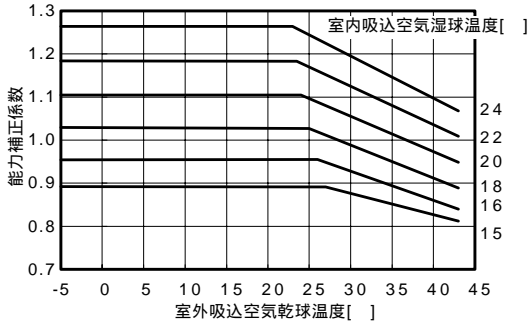

・暖房能力・入力補正

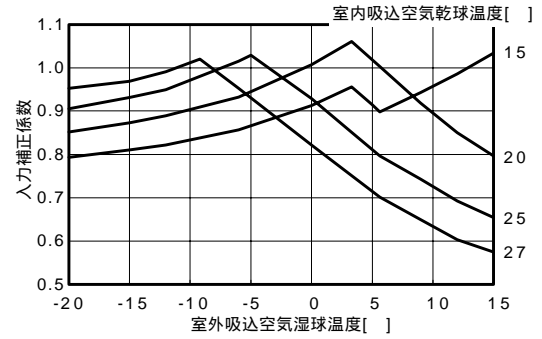
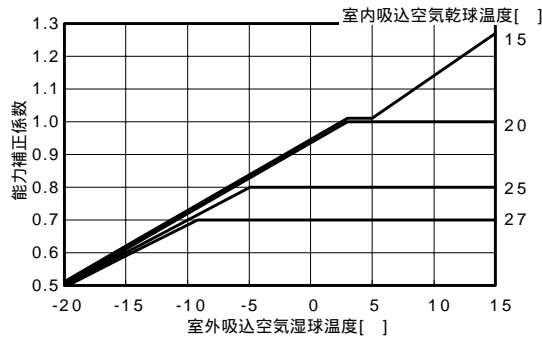

・冷房能力・入力補正（オールフレッシュ）

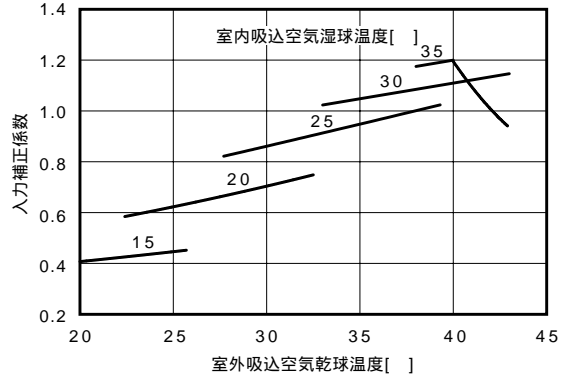
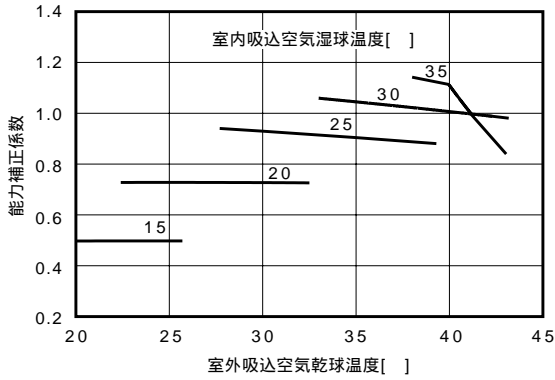

・暖房能力・入力補正（オールフレッシュ）

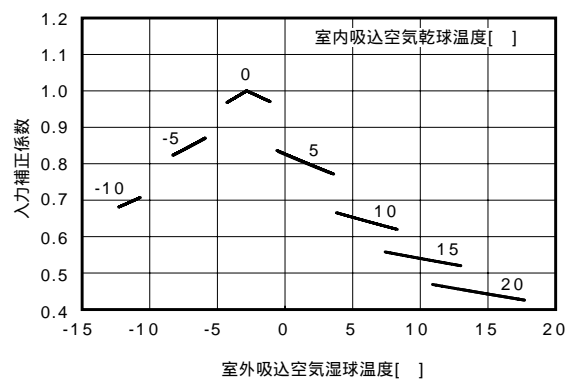
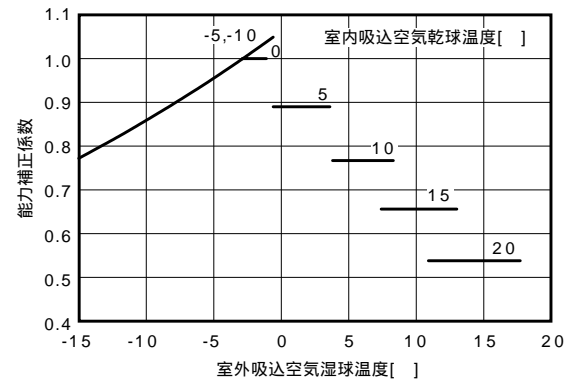

c. 冷媒配管長補正

【冷房能力補正係数】

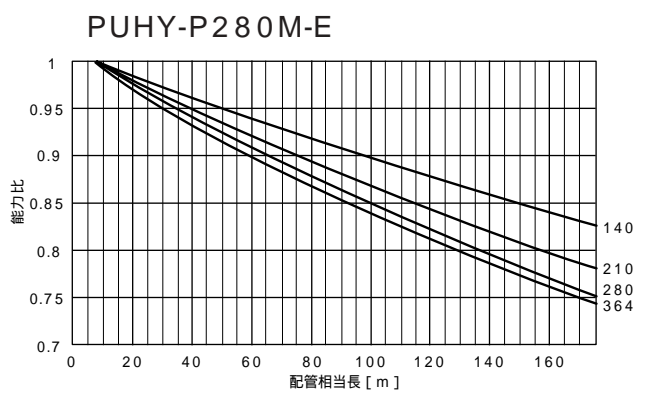
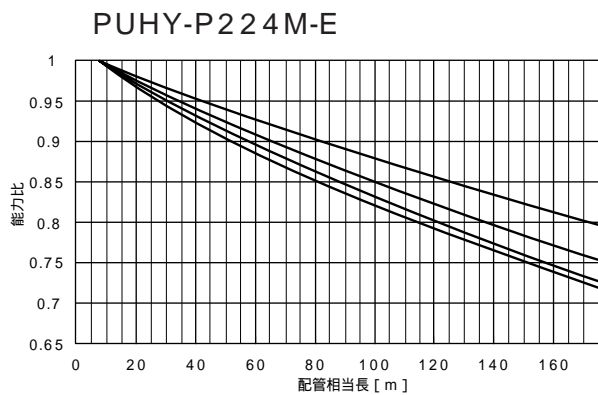
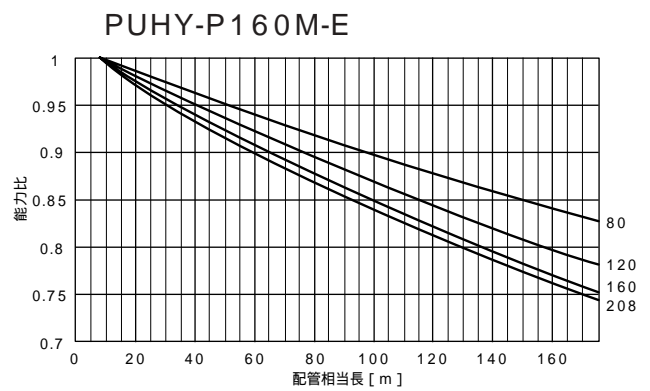
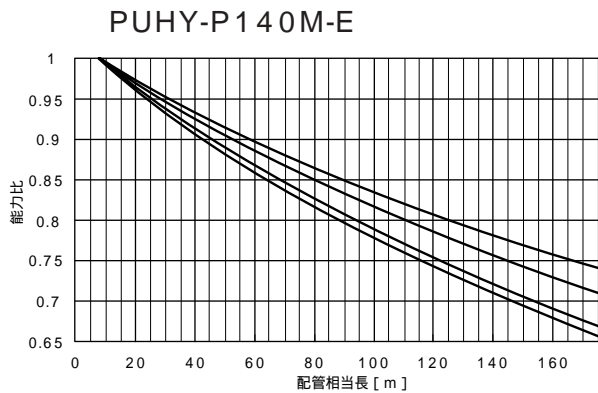

【暖房能力補正係数】

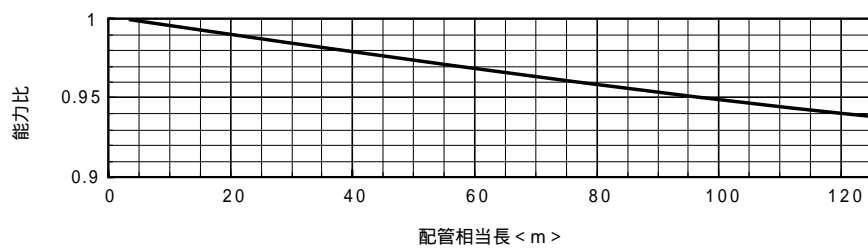

【配管相当長の求め方】

- (1) PUHY-P140M-E形 相当長 = (最遠室内ユニットまでの配管実長) + (0.30 × 配管途中のバンド数) m
- (2) PUHY-P160M-E形 相当長 = (最遠室内ユニットまでの配管実長) + (0.35 × 配管途中のバンド数) m
- (3) PUHY-P224M-E形 相当長 = (最遠室内ユニットまでの配管実長) + (0.35 × 配管途中のバンド数) m
- (4) PUHY-P280M-E形 相当長 = (最遠室内ユニットまでの配管実長) + (0.42 × 配管途中のバンド数) m

d. 霜取補正

室外吸込空気温度 < 湿球温度 >		6	4	2	1	0	-2	-4	-6	-8	-10
霜取補正係数	P140 P160形	1.0	0.94	0.83	0.81	0.83	0.87	0.90	0.90	0.93	0.93
	P224 P280形	1.0	0.95	0.84	0.83	0.83	0.87	0.90	0.95	0.95	0.95

P335～P450M-E形  
a. 標準能力表  
【PUHY-P335M-E】

室内工小 合計容量	能力 (kW)		入力 (kW)	
	冷房	暖房	冷房	暖房
168	16.8	18.8	3.91	4.54
169	16.9	19.0	3.93	4.56
170	17.0	19.0	3.95	4.59
171	17.1	19.0	3.98	4.61
172	17.2	19.2	4.00	4.63
173	17.3	19.3	4.03	4.66
174	17.4	19.5	4.05	4.68
175	17.5	19.5	4.07	4.71
176	17.6	19.7	4.10	4.73
177	17.7	20.0	4.12	4.75
178	17.8	20.0	4.15	4.78
179	17.9	20.0	4.17	4.80
180	18.0	20.0	4.20	4.82
181	18.1	20.2	4.22	4.85
182	18.2	20.3	4.24	4.87
183	18.3	20.6	4.27	4.90
184	18.4	20.6	4.29	4.92
185	18.5	20.8	4.32	4.94
186	18.6	20.8	4.34	4.97
187	18.7	21.0	4.37	4.99
188	18.8	21.0	4.39	5.01
189	18.9	21.0	4.42	5.04
190	19.0	21.2	4.44	5.06
191	19.1	21.3	4.47	5.09
192	19.2	21.5	4.49	5.11
193	19.3	21.6	4.52	5.13
194	19.4	21.7	4.54	5.16
195	19.5	21.8	4.57	5.18
196	19.6	22.0	4.59	5.21
197	19.7	22.0	4.62	5.23
198	19.8	22.0	4.64	5.26
199	19.9	22.2	4.67	5.28
200	20.0	22.3	4.69	5.30
201	20.1	22.5	4.72	5.33
202	20.2	22.6	4.74	5.35
203	20.3	22.7	4.77	5.38
204	20.4	22.9	4.80	5.40
205	20.5	23.0	4.82	5.43
206	20.6	23.0	4.85	5.45
207	20.7	23.0	4.87	5.48
208	20.8	23.2	4.90	5.50
209	20.9	23.3	4.93	5.53
210	21.0	23.5	4.95	5.55
211	21.1	23.8	4.98	5.58
212	21.2	23.8	5.01	5.60
213	21.3	23.9	5.03	5.63
214	21.4	24.0	5.06	5.65
215	21.5	24.0	5.09	5.67
216	21.6	24.0	5.11	5.70
217	21.7	24.2	5.14	5.73
218	21.8	24.3	5.17	5.75
219	21.9	24.5	5.19	5.78
220	22.0	24.6	5.22	5.80
221	22.1	24.8	5.25	5.83
222	22.2	25.0	5.28	5.85
223	22.3	25.0	5.31	5.88
224	22.4	25.0	5.33	5.90
225	22.5	25.0	5.36	5.93
226	22.6	25.2	5.39	5.95
227	22.7	25.3	5.42	5.98
228	22.8	25.5	5.45	6.00
229	22.9	25.6	5.47	6.03
230	23.0	25.8	5.50	6.05
231	23.1	26.0	5.53	6.08
232	23.2	26.0	5.56	6.11
233	23.3	26.0	5.59	6.13
234	23.4	26.0	5.62	6.16
235	23.5	26.2	5.65	6.18
236	23.6	26.3	5.68	6.21
237	23.7	26.5	5.71	6.24

室内工小 合計容量	能力 (kW)		入力 (kW)	
	冷房	暖房	冷房	暖房
238	23.8	26.6	5.74	6.26
239	23.9	26.9	5.77	6.29
240	24.0	26.9	5.80	6.31
241	24.1	27.0	5.83	6.34
242	24.2	27.0	5.86	6.37
243	24.3	27.0	5.89	6.39
244	24.4	27.2	5.92	6.42
245	24.5	27.3	5.95	6.45
246	24.6	27.5	5.98	6.47
247	24.7	27.6	6.01	6.50
248	24.8	27.8	6.04	6.53
249	24.9	27.9	6.08	6.55
250	25.0	28.0	6.11	6.58
251	25.1	28.0	6.14	6.61
252	25.2	28.0	6.17	6.63
253	25.3	28.2	6.20	6.66
254	25.4	28.3	6.24	6.69
255	25.5	28.5	6.27	6.71
256	25.6	28.6	6.30	6.74
257	25.7	28.8	6.33	6.77
258	25.8	28.9	6.37	6.79
259	25.9	29.0	6.40	6.82
260	26.0	29.0	6.43	6.85
261	26.1	29.0	6.47	6.88
262	26.2	29.2	6.50	6.90
263	26.3	29.3	6.53	6.93
264	26.4	29.5	6.57	6.96
265	26.5	29.6	6.60	6.99
266	26.6	29.8	6.64	7.01
267	26.7	30.0	6.67	7.04
268	26.8	30.0	6.71	7.07
269	26.9	30.0	6.74	7.10
270	27.0	30.0	6.78	7.13
271	27.1	30.2	6.81	7.15
272	27.2	30.3	6.85	7.18
273	27.3	30.5	6.88	7.21
274	27.4	30.6	6.92	7.24
275	27.5	30.8	6.96	7.27
276	27.6	30.9	6.99	7.30
277	27.7	31.0	7.03	7.32
278	27.8	31.0	7.07	7.35
279	27.9	31.0	7.10	7.38
280	28.0	31.2	7.14	7.41
281	28.1	31.3	7.18	7.44
282	28.2	31.5	7.22	7.47
283	28.3	31.6	7.25	7.50
284	28.4	31.8	7.29	7.52
285	28.5	31.9	7.33	7.55
286	28.6	32.0	7.37	7.58
287	28.7	32.0	7.41	7.61
288	28.8	32.0	7.45	7.64
289	28.9	32.2	7.49	7.67
290	29.0	32.3	7.53	7.70
291	29.1	32.5	7.57	7.73
292	29.2	32.6	7.61	7.76
293	29.3	32.8	7.65	7.79
294	29.4	32.9	7.69	7.82
295	29.5	33.0	7.73	7.85
296	29.6	33.0	7.77	7.88
297	29.7	33.0	7.81	7.91
298	29.8	33.2	7.85	7.94
299	29.9	33.3	7.89	7.97
300	30.0	33.5	7.94	8.00
301	30.1	33.6	7.98	8.03
302	30.2	33.8	8.02	8.06
303	30.3	33.9	8.06	8.09
304	30.4	34.0	8.11	8.12
305	30.5	34.0	8.15	8.15
306	30.6	34.0	8.19	8.18
307	30.7	34.2	8.24	8.21

室内工小 合計容量	能力 (kW)		入力 (kW)	
	冷房	暖房	冷房	暖房
308	30.8	34.3	8.28	8.24
309	30.9	34.5	8.32	8.27
310	31.0	34.6	8.37	8.30
311	31.1	34.8	8.41	8.33
312	31.2	34.9	8.46	8.36
313	31.3	35.0	8.50	8.39
314	31.4	35.0	8.55	8.43
315	31.5	35.0	8.60	8.46
316	31.6	35.2	8.64	8.49
317	31.7	35.3	8.69	8.52
318	31.8	35.5	8.74	8.55
319	31.9	35.6	8.78	8.58
320	32.0	35.8	8.83	8.62
321	32.1	35.9	8.88	8.65
322	32.2	36.0	8.93	8.68
323	32.3	36.0	8.97	8.71
324	32.4	36.0	9.02	8.74
325	32.5	36.2	9.07	8.78
326	32.6	36.3	9.12	8.81
327	32.7	36.5	9.17	8.84
328	32.8	36.6	9.22	8.87
329	32.9	36.8	9.27	8.90
330	33.0	36.9	9.32	8.94
331	33.1	37.0	9.37	8.97
332	33.2	37.0	9.42	9.00
333	33.3	37.0	9.47	9.04
334	33.4	37.2	9.52	9.07
335	33.5	37.5	9.57	9.10
336	33.5	37.5	9.57	9.09
337	33.6	37.5	9.57	9.08
338	33.6	37.5	9.57	9.08
339	33.6	37.5	9.57	9.07
340	33.7	37.5	9.57	9.07
341	33.7	37.5	9.57	9.06
342	33.8	37.5	9.57	9.06
343	33.8	37.5	9.57	9.05
344	33.8	37.5	9.57	9.04
345	33.9	37.5	9.57	9.04
346	33.9	37.5	9.57	9.03
347	33.9	37.5	9.57	9.03
348	34.0	37.6	9.57	9.02
349	34.0	37.6	9.57	9.01
350	34.1	37.6	9.57	9.01
351	34.1	37.6	9.57	9.00
352	34.1	37.6	9.57	9.00
353	34.2	37.6	9.57	8.99
354	34.2	37.6	9.57	8.99
355	34.2	37.6	9.57	8.98
356	34.3	37.6	9.57	8.97
357	34.3	37.6	9.57	8.97
358	34.3	37.6	9.57	8.96
359	34.4	37.6	9.57	8.96
360	34.4	37.6	9.57	8.95
361	34.5	37.6	9.57	8.95
362	34.5	37.6	9.57	8.94
363	34.5	37.6	9.57	8.93
364	34.6	37.6	9.57	8.93
365	34.6	37.6	9.57	8.92
366	34.6	37.6	9.57	8.92
367	34.7	37.6	9.57	8.91
368	34.7	37.6	9.57	8.90
369	34.7	37.6	9.57	8.90
370	34.8	37.6	9.57	8.89
371	34.8	37.6	9.57	8.89
372	34.9	37.6	9.57	8.88
373	34.9	37.6	9.57	8.88
374	34.9	37.7	9.57	8.87
375	35.0	37.7	9.57	8.86
376	35.0	37.7	9.57	8.86
377	35.0	37.7	9.57	8.85

## 【PUHY-P335M-E】

室内ユニット 合計容量	能力 (kW)		入力 (kW)	
	冷房	暖房	冷房	暖房
378	35.1	37.7	9.57	8.85
379	35.1	37.7	9.57	8.84
380	35.2	37.7	9.57	8.84
381	35.2	37.7	9.57	8.83
382	35.2	37.7	9.57	8.82
383	35.3	37.7	9.57	8.82
384	35.3	37.7	9.57	8.81
385	35.3	37.7	9.57	8.81
386	35.4	37.7	9.57	8.80
387	35.4	37.7	9.57	8.79
388	35.4	37.7	9.57	8.79
389	35.5	37.7	9.57	8.78
390	35.5	37.7	9.57	8.78
391	35.6	37.7	9.57	8.77
392	35.6	37.7	9.57	8.77
393	35.6	37.7	9.57	8.76
394	35.7	37.7	9.57	8.75
395	35.7	37.7	9.57	8.75
396	35.7	37.7	9.57	8.74
397	35.8	37.7	9.57	8.74
398	35.8	37.7	9.57	8.73
399	35.8	37.8	9.57	8.72
400	35.9	37.8	9.57	8.72
401	35.9	37.8	9.57	8.71
402	36.0	37.8	9.57	8.71
403	36.0	37.8	9.57	8.70
404	36.0	37.8	9.57	8.70
405	36.1	37.8	9.57	8.69
406	36.1	37.8	9.57	8.68
407	36.1	37.8	9.57	8.68
408	36.2	37.8	9.57	8.67
409	36.2	37.8	9.58	8.67
410	36.3	37.8	9.58	8.66
411	36.3	37.8	9.58	8.66
412	36.3	37.8	9.58	8.65
413	36.4	37.8	9.58	8.64
414	36.4	37.8	9.58	8.64
415	36.4	37.8	9.58	8.63
416	36.5	37.8	9.58	8.63
417	36.5	37.8	9.58	8.62
418	36.5	37.8	9.58	8.61
419	36.6	37.8	9.58	8.61
420	36.6	37.8	9.58	8.60
421	36.7	37.8	9.58	8.60
422	36.7	37.8	9.58	8.59
423	36.7	37.8	9.58	8.59
424	36.8	37.8	9.58	8.58
425	36.8	37.9	9.58	8.57
426	36.8	37.9	9.58	8.57
427	36.9	37.9	9.58	8.56
428	36.9	37.9	9.58	8.56
429	36.9	37.9	9.58	8.55
430	37.0	37.9	9.58	8.55
431	37.0	37.9	9.58	8.54
432	37.1	37.9	9.58	8.53
433	37.1	37.9	9.58	8.53
434	37.1	37.9	9.58	8.52
435	37.2	37.9	9.58	8.52

【PUHY-P355M-E】

室内ユニット 合計容量	能力 (kW)		入力 (kW)	
	冷房	暖房	冷房	暖房
178	17.8	20.0	4.34	4.79
179	17.9	20.0	4.36	4.82
180	18.0	20.0	4.39	4.84
181	18.1	20.2	4.41	4.86
182	18.2	20.3	4.43	4.89
183	18.3	20.6	4.46	4.91
184	18.4	20.6	4.48	4.93
185	18.5	20.8	4.50	4.95
186	18.6	20.8	4.53	4.98
187	18.7	21.0	4.55	5.00
188	18.8	21.0	4.57	5.02
189	18.9	21.0	4.60	5.05
190	19.0	21.2	4.62	5.07
191	19.1	21.3	4.64	5.09
192	19.2	21.5	4.67	5.12
193	19.3	21.6	4.69	5.14
194	19.4	21.7	4.71	5.16
195	19.5	21.8	4.74	5.19
196	19.6	22.0	4.76	5.21
197	19.7	22.0	4.78	5.23
198	19.8	22.0	4.81	5.26
199	19.9	22.2	4.83	5.28
200	20.0	22.3	4.86	5.30
201	20.1	22.5	4.88	5.33
202	20.2	22.6	4.90	5.35
203	20.3	22.7	4.93	5.37
204	20.4	22.9	4.95	5.40
205	20.5	23.0	4.98	5.42
206	20.6	23.0	5.00	5.45
207	20.7	23.0	5.03	5.47
208	20.8	23.2	5.05	5.49
209	20.9	23.3	5.07	5.52
210	21.0	23.5	5.10	5.54
211	21.1	23.8	5.12	5.56
212	21.2	23.8	5.15	5.59
213	21.3	23.9	5.17	5.61
214	21.4	24.0	5.20	5.64
215	21.5	24.0	5.22	5.66
216	21.6	24.0	5.25	5.68
217	21.7	24.2	5.27	5.71
218	21.8	24.3	5.30	5.73
219	21.9	24.5	5.32	5.76
220	22.0	24.6	5.35	5.78
221	22.1	24.8	5.37	5.81
222	22.2	25.0	5.40	5.83
223	22.3	25.0	5.42	5.85
224	22.4	25.0	5.45	5.88
225	22.5	25.0	5.47	5.90
226	22.6	25.2	5.50	5.93
227	22.7	25.3	5.52	5.95
228	22.8	25.5	5.55	5.98
229	22.9	25.6	5.57	6.00
230	23.0	25.8	5.60	6.03
231	23.1	26.0	5.63	6.05
232	23.2	26.0	5.65	6.08
233	23.3	26.0	5.68	6.10
234	23.4	26.0	5.70	6.13
235	23.5	26.2	5.73	6.15
236	23.6	26.3	5.76	6.18
237	23.7	26.5	5.78	6.20
238	23.8	26.6	5.81	6.23
239	23.9	26.9	5.84	6.25
240	24.0	26.9	5.86	6.28
241	24.1	27.0	5.89	6.30
242	24.2	27.0	5.92	6.33
243	24.3	27.0	5.94	6.35
244	24.4	27.2	5.97	6.38
245	24.5	27.3	6.00	6.40
246	24.6	27.5	6.02	6.43
247	24.7	27.6	6.05	6.46

室内ユニット 合計容量	能力 (kW)		入力 (kW)	
	冷房	暖房	冷房	暖房
248	24.8	27.8	6.08	6.48
249	24.9	27.9	6.11	6.51
250	25.0	28.0	6.13	6.53
251	25.1	28.0	6.16	6.56
252	25.2	28.0	6.19	6.59
253	25.3	28.2	6.22	6.61
254	25.4	28.3	6.25	6.64
255	25.5	28.5	6.27	6.66
256	25.6	28.6	6.30	6.69
257	25.7	28.8	6.33	6.72
258	25.8	28.9	6.36	6.74
259	25.9	29.0	6.39	6.77
260	26.0	29.0	6.42	6.80
261	26.1	29.0	6.44	6.82
262	26.2	29.2	6.47	6.85
263	26.3	29.3	6.50	6.88
264	26.4	29.5	6.53	6.90
265	26.5	29.6	6.56	6.93
266	26.6	29.8	6.59	6.96
267	26.7	30.0	6.62	6.99
268	26.8	30.0	6.65	7.01
269	26.9	30.0	6.68	7.04
270	27.0	30.0	6.71	7.07
271	27.1	30.2	6.74	7.09
272	27.2	30.3	6.77	7.12
273	27.3	30.5	6.80	7.15
274	27.4	30.6	6.83	7.18
275	27.5	30.8	6.86	7.21
276	27.6	30.9	6.89	7.23
277	27.7	31.0	6.92	7.26
278	27.8	31.0	6.95	7.29
279	27.9	31.0	6.98	7.32
280	28.0	31.2	7.01	7.35
281	28.1	31.3	7.04	7.37
282	28.2	31.5	7.08	7.40
283	28.3	31.6	7.11	7.43
284	28.4	31.8	7.14	7.46
285	28.5	31.9	7.17	7.49
286	28.6	32.0	7.20	7.52
287	28.7	32.0	7.23	7.54
288	28.8	32.0	7.27	7.57
289	28.9	32.2	7.30	7.60
290	29.0	32.3	7.33	7.63
291	29.1	32.5	7.36	7.66
292	29.2	32.6	7.40	7.69
293	29.3	32.8	7.43	7.72
294	29.4	32.9	7.46	7.75
295	29.5	33.0	7.50	7.78
296	29.6	33.0	7.53	7.81
297	29.7	33.0	7.56	7.84
298	29.8	33.2	7.60	7.87
299	29.9	33.3	7.63	7.90
300	30.0	33.5	7.66	7.93
301	30.1	33.6	7.70	7.96
302	30.2	33.8	7.73	7.99
303	30.3	33.9	7.77	8.02
304	30.4	34.0	7.80	8.05
305	30.5	34.0	7.84	8.08
306	30.6	34.0	7.87	8.11
307	30.7	34.2	7.91	8.14
308	30.8	34.3	7.94	8.17
309	30.9	34.5	7.98	8.20
310	31.0	34.6	8.01	8.23
311	31.1	34.8	8.05	8.26
312	31.2	34.9	8.08	8.29
313	31.3	35.0	8.12	8.33
314	31.4	35.0	8.16	8.36
315	31.5	35.0	8.19	8.39
316	31.6	35.2	8.23	8.42
317	31.7	35.3	8.27	8.45

室内ユニット 合計容量	能力 (kW)		入力 (kW)	
	冷房	暖房	冷房	暖房
318	31.8	35.5	8.30	8.48
319	31.9	35.6	8.34	8.52
320	32.0	35.8	8.38	8.55
321	32.1	35.9	8.41	8.58
322	32.2	36.0	8.45	8.61
323	32.3	36.0	8.49	8.64
324	32.4	36.0	8.53	8.68
325	32.5	36.2	8.57	8.71
326	32.6	36.3	8.60	8.74
327	32.7	36.5	8.64	8.78
328	32.8	36.6	8.68	8.81
329	32.9	36.8	8.72	8.84
330	33.0	36.9	8.76	8.87
331	33.1	37.0	8.80	8.91
332	33.2	37.0	8.84	8.94
333	33.3	37.0	8.88	8.97
334	33.4	37.2	8.92	9.01
335	33.5	37.3	8.96	9.04
336	33.6	37.5	9.00	9.08
337	33.7	37.6	9.04	9.11
338	33.8	37.8	9.08	9.14
339	33.9	37.9	9.12	9.18
340	34.0	38.0	9.16	9.21
341	34.1	38.0	9.20	9.25
342	34.2	38.0	9.24	9.28
343	34.3	38.2	9.29	9.32
344	34.4	38.3	9.33	9.35
345	34.5	38.5	9.37	9.39
346	34.6	38.6	9.41	9.42
347	34.7	38.8	9.45	9.46
348	34.8	38.9	9.50	9.49
349	34.9	39.0	9.54	9.53
350	35.0	39.0	9.58	9.56
351	35.1	39.0	9.63	9.60
352	35.2	39.2	9.67	9.63
353	35.3	39.3	9.71	9.67
354	35.4	39.5	9.76	9.71
355	35.5	40.0	9.80	9.74
356	35.5	40.0	9.80	9.74
357	35.6	40.0	9.80	9.73
358	35.6	40.0	9.80	9.72
359	35.6	40.0	9.80	9.71
360	35.7	40.0	9.80	9.71
361	35.7	40.0	9.80	9.70
362	35.8	40.0	9.80	9.69
363	35.8	40.0	9.80	9.68
364	35.8	40.0	9.80	9.67
365	35.9	40.0	9.80	9.67
366	35.9	40.0	9.80	9.66
367	35.9	40.0	9.80	9.65
368	36.0	40.1	9.80	9.64
369	36.0	40.1	9.80	9.64
370	36.1	40.1	9.80	9.63
371	36.1	40.1	9.80	9.62
372	36.1	40.1	9.80	9.61
373	36.2	40.1	9.80	9.60
374	36.2	40.1	9.80	9.60
375	36.2	40.1	9.80	9.59
376	36.3	40.1	9.80	9.58
377	36.3	40.1	9.80	9.57
378	36.3	40.1	9.80	9.57
379	36.4	40.1	9.80	9.56
380	36.4	40.1	9.80	9.55
381	36.5	40.1	9.80	9.54
382	36.5	40.1	9.80	9.53
383	36.5	40.1	9.80	9.53
384	36.6	40.1	9.80	9.52
385	36.6	40.1	9.80	9.51
386	36.6	40.1	9.80	9.50
387	36.7	40.1	9.80	9.50

**【PUHY-P355M-E】**

室内ユニット 合計容量	能力 (kW)		入力 (kW)	
	冷房	暖房	冷房	暖房
388	36.7	40.1	9.80	9.49
389	36.7	40.1	9.80	9.48
390	36.8	40.1	9.80	9.47
391	36.8	40.1	9.80	9.46
392	36.9	40.1	9.80	9.46
393	36.9	40.1	9.80	9.45
394	36.9	40.2	9.80	9.44
395	37.0	40.2	9.80	9.43
396	37.0	40.2	9.80	9.43
397	37.0	40.2	9.80	9.42
398	37.1	40.2	9.80	9.41
399	37.1	40.2	9.80	9.40
400	37.2	40.2	9.80	9.39
401	37.2	40.2	9.80	9.39
402	37.2	40.2	9.80	9.38
403	37.3	40.2	9.80	9.37
404	37.3	40.2	9.80	9.36
405	37.3	40.2	9.80	9.36
406	37.4	40.2	9.80	9.35
407	37.4	40.2	9.80	9.34
408	37.4	40.2	9.80	9.33
409	37.5	40.2	9.80	9.32
410	37.5	40.2	9.80	9.32
411	37.6	40.2	9.80	9.31
412	37.6	40.2	9.80	9.30
413	37.6	40.2	9.80	9.29
414	37.7	40.2	9.80	9.29
415	37.7	40.2	9.80	9.28
416	37.7	40.2	9.80	9.27
417	37.8	40.2	9.80	9.26
418	37.8	40.2	9.80	9.26
419	37.8	40.3	9.80	9.25
420	37.9	40.3	9.80	9.24
421	37.9	40.3	9.80	9.23
422	38.0	40.3	9.80	9.22
423	38.0	40.3	9.80	9.22
424	38.0	40.3	9.80	9.21
425	38.1	40.3	9.80	9.20
426	38.1	40.3	9.80	9.19
427	38.1	40.3	9.80	9.19
428	38.2	40.3	9.80	9.18
429	38.2	40.3	9.80	9.17
430	38.3	40.3	9.80	9.16
431	38.3	40.3	9.80	9.15
432	38.3	40.3	9.80	9.15
433	38.4	40.3	9.80	9.14
434	38.4	40.3	9.80	9.13
435	38.4	40.3	9.80	9.12
436	38.5	40.3	9.80	9.12
437	38.5	40.3	9.80	9.11
438	38.5	40.3	9.80	9.10
439	38.6	40.3	9.80	9.09
440	38.6	40.3	9.80	9.08
441	38.7	40.3	9.80	9.08
442	38.7	40.3	9.80	9.07
443	38.7	40.3	9.80	9.06
444	38.8	40.3	9.80	9.05
445	38.8	40.4	9.80	9.05
446	38.8	40.4	9.80	9.04
447	38.9	40.4	9.80	9.03
448	38.9	40.4	9.80	9.02
449	38.9	40.4	9.80	9.01
450	39.0	40.4	9.80	9.01
451	39.0	40.4	9.80	9.00
452	39.1	40.4	9.80	8.99
453	39.1	40.4	9.80	8.98
454	39.1	40.4	9.80	8.98
455	39.2	40.4	9.80	8.97
456	39.2	40.4	9.80	8.96
457	39.2	40.4	9.80	8.95

室内ユニット 合計容量	能力 (kW)		入力 (kW)	
	冷房	暖房	冷房	暖房
458	39.3	40.4	9.80	8.94
459	39.3	40.4	9.80	8.94
460	39.4	40.4	9.80	8.93
461	39.4	40.4	9.80	8.92

【PUHY-P400M-E】

室内ユニット 合計容量	能力 (kW)		入力 (kW)	
	冷房	暖房	冷房	暖房
200	20.0	22.3	5.01	5.47
201	20.1	22.5	5.04	5.50
202	20.2	22.6	5.06	5.52
203	20.3	22.7	5.08	5.55
204	20.4	22.9	5.11	5.57
205	20.5	23.0	5.13	5.60
206	20.6	23.0	5.16	5.62
207	20.7	23.0	5.18	5.65
208	20.8	23.2	5.21	5.68
209	20.9	23.3	5.23	5.70
210	21.0	23.5	5.26	5.73
211	21.1	23.8	5.28	5.75
212	21.2	23.8	5.30	5.78
213	21.3	23.9	5.33	5.80
214	21.4	24.0	5.35	5.83
215	21.5	24.0	5.38	5.85
216	21.6	24.0	5.40	5.88
217	21.7	24.2	5.43	5.90
218	21.8	24.3	5.45	5.93
219	21.9	24.5	5.48	5.95
220	22.0	24.6	5.50	5.98
221	22.1	24.8	5.53	6.01
222	22.2	25.0	5.55	6.03
223	22.3	25.0	5.58	6.06
224	22.4	25.0	5.60	6.08
225	22.5	25.0	5.63	6.11
226	22.6	25.2	5.65	6.13
227	22.7	25.3	5.68	6.16
228	22.8	25.5	5.70	6.18
229	22.9	25.6	5.73	6.21
230	23.0	25.8	5.75	6.24
231	23.1	26.0	5.78	6.26
232	23.2	26.0	5.80	6.29
233	23.3	26.0	5.83	6.31
234	23.4	26.0	5.86	6.34
235	23.5	26.2	5.88	6.36
236	23.6	26.3	5.91	6.39
237	23.7	26.5	5.93	6.42
238	23.8	26.6	5.96	6.44
239	23.9	26.9	5.98	6.47
240	24.0	26.9	6.01	6.49
241	24.1	27.0	6.03	6.52
242	24.2	27.0	6.06	6.55
243	24.3	27.0	6.09	6.57
244	24.4	27.2	6.11	6.60
245	24.5	27.3	6.14	6.62
246	24.6	27.5	6.16	6.65
247	24.7	27.6	6.19	6.68
248	24.8	27.8	6.22	6.70
249	24.9	27.9	6.24	6.73
250	25.0	28.0	6.27	6.75
251	25.1	28.0	6.30	6.78
252	25.2	28.0	6.32	6.81
253	25.3	28.2	6.35	6.83
254	25.4	28.3	6.38	6.86
255	25.5	28.5	6.40	6.89
256	25.6	28.6	6.43	6.91
257	25.7	28.8	6.46	6.94
258	25.8	28.9	6.48	6.96
259	25.9	29.0	6.51	6.99
260	26.0	29.0	6.54	7.02
261	26.1	29.0	6.56	7.04
262	26.2	29.2	6.59	7.07
263	26.3	29.3	6.62	7.10
264	26.4	29.5	6.64	7.12
265	26.5	29.6	6.67	7.15
266	26.6	29.8	6.70	7.18
267	26.7	30.0	6.73	7.20
268	26.8	30.0	6.75	7.23
269	26.9	30.0	6.78	7.25

室内ユニット 合計容量	能力 (kW)		入力 (kW)	
	冷房	暖房	冷房	暖房
270	27.0	30.0	6.81	7.28
271	27.1	30.2	6.84	7.31
272	27.2	30.3	6.87	7.33
273	27.3	30.5	6.89	7.36
274	27.4	30.6	6.92	7.39
275	27.5	30.8	6.95	7.41
276	27.6	30.9	6.98	7.44
277	27.7	31.0	7.01	7.47
278	27.8	31.0	7.03	7.49
279	27.9	31.0	7.06	7.52
280	28.0	31.2	7.09	7.55
281	28.1	31.3	7.12	7.58
282	28.2	31.5	7.15	7.60
283	28.3	31.6	7.18	7.63
284	28.4	31.8	7.21	7.66
285	28.5	31.9	7.24	7.68
286	28.6	32.0	7.26	7.71
287	28.7	32.0	7.29	7.74
288	28.8	32.0	7.32	7.76
289	28.9	32.2	7.35	7.79
290	29.0	32.3	7.38	7.82
291	29.1	32.5	7.41	7.85
292	29.2	32.6	7.44	7.87
293	29.3	32.8	7.47	7.90
294	29.4	32.9	7.50	7.93
295	29.5	33.0	7.53	7.95
296	29.6	33.0	7.56	7.98
297	29.7	33.0	7.59	8.01
298	29.8	33.2	7.62	8.04
299	29.9	33.3	7.65	8.06
300	30.0	33.5	7.68	8.09
301	30.1	33.6	7.71	8.12
302	30.2	33.8	7.74	8.15
303	30.3	33.9	7.77	8.17
304	30.4	34.0	7.80	8.20
305	30.5	34.0	7.84	8.23
306	30.6	34.0	7.87	8.26
307	30.7	34.2	7.90	8.28
308	30.8	34.3	7.93	8.31
309	30.9	34.5	7.96	8.34
310	31.0	34.6	7.99	8.37
311	31.1	34.8	8.02	8.40
312	31.2	34.9	8.05	8.42
313	31.3	35.0	8.09	8.45
314	31.4	35.0	8.12	8.48
315	31.5	35.0	8.15	8.51
316	31.6	35.2	8.18	8.54
317	31.7	35.3	8.22	8.56
318	31.8	35.5	8.25	8.59
319	31.9	35.6	8.28	8.62
320	32.0	35.8	8.31	8.65
321	32.1	35.9	8.35	8.68
322	32.2	36.0	8.38	8.70
323	32.3	36.0	8.41	8.73
324	32.4	36.0	8.44	8.76
325	32.5	36.2	8.48	8.79
326	32.6	36.3	8.51	8.82
327	32.7	36.5	8.54	8.85
328	32.8	36.6	8.58	8.87
329	32.9	36.8	8.61	8.90
330	33.0	36.9	8.65	8.93
331	33.1	37.0	8.68	8.96
332	33.2	37.0	8.71	8.99
333	33.3	37.0	8.75	9.02
334	33.4	37.2	8.78	9.04
335	33.5	37.3	8.82	9.07
336	33.6	37.5	8.85	9.10
337	33.7	37.5	8.89	9.13
338	33.8	37.7	8.92	9.16
339	33.9	37.8	8.96	9.19

室内ユニット 合計容量	能力 (kW)		入力 (kW)	
	冷房	暖房	冷房	暖房
340	34.0	38.0	8.99	9.22
341	34.1	38.0	9.03	9.25
342	34.2	38.0	9.06	9.27
343	34.3	38.2	9.10	9.30
344	34.4	38.3	9.13	9.33
345	34.5	38.5	9.17	9.36
346	34.6	38.5	9.21	9.39
347	34.7	38.7	9.24	9.42
348	34.8	38.8	9.28	9.45
349	34.9	39.0	9.32	9.48
350	35.0	39.0	9.35	9.51
351	35.1	39.0	9.39	9.54
352	35.2	39.2	9.43	9.57
353	35.3	39.3	9.46	9.60
354	35.4	39.5	9.50	9.62
355	35.5	39.5	9.54	9.65
356	35.6	39.7	9.58	9.68
357	35.7	39.8	9.61	9.71
358	35.8	40.0	9.65	9.74
359	35.9	40.0	9.69	9.77
360	36.0	40.0	9.73	9.80
361	36.1	40.2	9.77	9.83
362	36.2	40.3	9.80	9.86
363	36.3	40.5	9.84	9.89
364	36.4	40.5	9.88	9.92
365	36.5	40.7	9.92	9.95
366	36.6	40.8	9.96	9.98
367	36.7	41.0	10.00	10.01
368	36.8	41.0	10.04	10.04
369	36.9	41.0	10.08	10.07
370	37.0	41.2	10.12	10.10
371	37.1	41.3	10.16	10.13
372	37.2	41.5	10.20	10.16
373	37.3	41.5	10.24	10.19
374	37.4	41.7	10.28	10.22
375	37.5	41.8	10.32	10.25
376	37.6	42.0	10.36	10.28
377	37.7	42.0	10.40	10.31
378	37.8	42.0	10.44	10.34
379	37.9	42.2	10.48	10.37
380	38.0	42.3	10.52	10.40
381	38.1	42.5	10.57	10.43
382	38.2	42.5	10.61	10.46
383	38.3	42.7	10.65	10.49
384	38.4	42.8	10.69	10.53
385	38.5	43.0	10.73	10.56
386	38.6	43.0	10.78	10.59
387	38.7	43.0	10.82	10.62
388	38.8	43.2	10.86	10.65
389	38.9	43.3	10.90	10.68
390	39.0	43.5	10.95	10.71
391	39.1	43.5	10.99	10.74
392	39.2	43.7	11.03	10.77
393	39.3	43.8	11.08	10.80
394	39.4	44.0	11.12	10.83
395	39.5	44.0	11.17	10.87
396	39.6	44.0	11.21	10.90
397	39.7	44.2	11.25	10.93
398	39.8	44.3	11.30	10.96
399	39.9	44.5	11.34	10.99
400	40.0	45.0	11.39	11.02
401	40.0	45.0	11.39	11.01
402	40.0	45.0	11.39	11.00
403	40.1	45.0	11.39	11.00
404	40.1	45.0	11.39	10.99
405	40.1	45.0	11.39	10.98
406	40.1	45.0	11.39	10.98
407	40.1	45.0	11.40	10.97
408	40.1	45.0	11.40	10.96
409	40.2	45.0	11.40	10.96

## 【PUHY-P400M-E】

室内ユニット 合計容量	能力 (kW)		入力 (kW)	
	冷房	暖房	冷房	暖房
410	40.2	45.0	11.40	10.95
411	40.2	45.0	11.40	10.94
412	40.2	45.0	11.40	10.94
413	40.2	45.0	11.40	10.93
414	40.2	45.0	11.40	10.92
415	40.3	45.0	11.40	10.92
416	40.3	45.0	11.40	10.91
417	40.3	45.0	11.40	10.91
418	40.3	45.0	11.40	10.90
419	40.3	45.0	11.40	10.89
420	40.3	45.0	11.40	10.89
421	40.4	45.0	11.40	10.88
422	40.4	45.0	11.40	10.87
423	40.4	45.0	11.40	10.87
424	40.4	45.0	11.40	10.86
425	40.4	45.0	11.40	10.85
426	40.4	45.0	11.40	10.85
427	40.5	45.0	11.40	10.84
428	40.5	45.0	11.40	10.83
429	40.5	45.0	11.40	10.83
430	40.5	45.1	11.40	10.82
431	40.5	45.1	11.40	10.81
432	40.5	45.1	11.40	10.81
433	40.6	45.1	11.40	10.80
434	40.6	45.1	11.40	10.79
435	40.6	45.1	11.40	10.79
436	40.6	45.1	11.40	10.78
437	40.6	45.1	11.40	10.78
438	40.6	45.1	11.40	10.77
439	40.7	45.1	11.40	10.76
440	40.7	45.1	11.40	10.76
441	40.7	45.1	11.40	10.75
442	40.7	45.1	11.40	10.74
443	40.7	45.1	11.40	10.74
444	40.7	45.1	11.40	10.73
445	40.8	45.1	11.40	10.72
446	40.8	45.1	11.40	10.72
447	40.8	45.1	11.40	10.71
448	40.8	45.1	11.40	10.70
449	40.8	45.1	11.40	10.70
450	40.8	45.1	11.40	10.69
451	40.9	45.1	11.40	10.68
452	40.9	45.1	11.40	10.68
453	40.9	45.1	11.40	10.67
454	40.9	45.1	11.40	10.66
455	40.9	45.1	11.41	10.66
456	40.9	45.1	11.41	10.65
457	41.0	45.1	11.41	10.64
458	41.0	45.1	11.41	10.64
459	41.0	45.1	11.41	10.63
460	41.0	45.1	11.41	10.63
461	41.0	45.1	11.41	10.62
462	41.0	45.1	11.41	10.61
463	41.1	45.1	11.41	10.61
464	41.1	45.1	11.41	10.60
465	41.1	45.1	11.41	10.59
466	41.1	45.1	11.41	10.59
467	41.1	45.1	11.41	10.58
468	41.1	45.1	11.41	10.57
469	41.2	45.1	11.41	10.57
470	41.2	45.1	11.41	10.56
471	41.2	45.1	11.41	10.55
472	41.2	45.1	11.41	10.55
473	41.2	45.1	11.41	10.54
474	41.2	45.1	11.41	10.53
475	41.3	45.1	11.41	10.53
476	41.3	45.1	11.41	10.52
477	41.3	45.1	11.41	10.51
478	41.3	45.1	11.41	10.51
479	41.3	45.1	11.41	10.50

室内ユニット 合計容量	能力 (kW)		入力 (kW)	
	冷房	暖房	冷房	暖房
480	41.3	45.1	11.41	10.50
481	41.4	45.1	11.41	10.49
482	41.4	45.1	11.41	10.48
483	41.4	45.1	11.41	10.48
484	41.4	45.1	11.41	10.47
485	41.4	45.1	11.41	10.46
486	41.4	45.1	11.41	10.46
487	41.5	45.1	11.41	10.45
488	41.5	45.1	11.41	10.44
489	41.5	45.2	11.41	10.44
490	41.5	45.2	11.41	10.43
491	41.5	45.2	11.41	10.42
492	41.5	45.2	11.41	10.42
493	41.6	45.2	11.41	10.41
494	41.6	45.2	11.41	10.40
495	41.6	45.2	11.41	10.40
496	41.6	45.2	11.41	10.39
497	41.6	45.2	11.41	10.38
498	41.6	45.2	11.41	10.38
499	41.7	45.2	11.41	10.37
500	41.7	45.2	11.41	10.37
501	41.7	45.2	11.41	10.36
502	41.7	45.2	11.41	10.35
503	41.7	45.2	11.42	10.35
504	41.7	45.2	11.42	10.34
505	41.8	45.2	11.42	10.33
506	41.8	45.2	11.42	10.33
507	41.8	45.2	11.42	10.32
508	41.8	45.2	11.42	10.31
509	41.8	45.2	11.42	10.31
510	41.8	45.2	11.42	10.30
511	41.9	45.2	11.42	10.29
512	41.9	45.2	11.42	10.29
513	41.9	45.2	11.42	10.28
514	41.9	45.2	11.42	10.27
515	41.9	45.2	11.42	10.27
516	41.9	45.2	11.42	10.26
517	42.0	45.2	11.42	10.25
518	42.0	45.2	11.42	10.25
519	42.0	45.2	11.42	10.24
520	42.0	45.2	11.42	10.23



【PUHY-P450M-E】

室内ユニット 合計容量	能力 (kW)		入力 (kW)	
	冷 房	暖 房	冷 房	暖 房
225	22.5	25.0	5.35	5.95
226	22.6	25.2	5.37	5.97
227	22.7	25.3	5.40	6.00
228	22.8	25.5	5.42	6.02
229	22.9	25.6	5.44	6.05
230	23.0	25.8	5.46	6.07
231	23.1	26.0	5.49	6.09
232	23.2	26.0	5.51	6.12
233	23.3	26.0	5.53	6.14
234	23.4	26.0	5.55	6.17
235	23.5	26.2	5.57	6.19
236	23.6	26.3	5.60	6.22
237	23.7	26.5	5.62	6.24
238	23.8	26.6	5.64	6.27
239	23.9	26.9	5.66	6.29
240	24.0	26.9	5.68	6.32
241	24.1	27.0	5.71	6.34
242	24.2	27.0	5.73	6.37
243	24.3	27.0	5.75	6.39
244	24.4	27.2	5.77	6.42
245	24.5	27.3	5.80	6.44
246	24.6	27.5	5.82	6.47
247	24.7	27.6	5.84	6.49
248	24.8	27.8	5.86	6.52
249	24.9	27.9	5.88	6.54
250	25.0	28.0	5.91	6.57
251	25.1	28.0	5.93	6.59
252	25.2	28.0	5.95	6.62
253	25.3	28.2	5.97	6.64
254	25.4	28.3	6.00	6.67
255	25.5	28.5	6.02	6.69
256	25.6	28.6	6.04	6.72
257	25.7	28.8	6.06	6.74
258	25.8	28.9	6.09	6.77
259	25.9	29.0	6.11	6.80
260	26.0	29.0	6.13	6.82
261	26.1	29.0	6.15	6.85
262	26.2	29.2	6.18	6.87
263	26.3	29.3	6.20	6.90
264	26.4	29.5	6.22	6.92
265	26.5	29.6	6.25	6.95
266	26.6	29.8	6.27	6.98
267	26.7	30.0	6.29	7.00
268	26.8	30.0	6.31	7.03
269	26.9	30.0	6.34	7.05
270	27.0	30.0	6.36	7.08
271	27.1	30.2	6.38	7.10
272	27.2	30.3	6.41	7.13
273	27.3	30.5	6.43	7.16
274	27.4	30.6	6.45	7.18
275	27.5	30.8	6.48	7.21
276	27.6	30.9	6.50	7.23
277	27.7	31.0	6.52	7.26
278	27.8	31.0	6.55	7.29
279	27.9	31.0	6.57	7.31
280	28.0	31.2	6.59	7.34
281	28.1	31.3	6.62	7.37
282	28.2	31.5	6.64	7.39
283	28.3	31.6	6.67	7.42
284	28.4	31.8	6.69	7.44
285	28.5	31.9	6.71	7.47
286	28.6	32.0	6.74	7.50
287	28.7	32.0	6.76	7.52
288	28.8	32.0	6.79	7.55
289	28.9	32.2	6.81	7.58
290	29.0	32.3	6.84	7.60
291	29.1	32.5	6.86	7.63
292	29.2	32.6	6.89	7.66
293	29.3	32.8	6.91	7.68
294	29.4	32.9	6.94	7.71

室内ユニット 合計容量	能力 (kW)		入力 (kW)	
	冷 房	暖 房	冷 房	暖 房
295	29.5	33.0	6.96	7.74
296	29.6	33.0	6.99	7.76
297	29.7	33.0	7.01	7.79
298	29.8	33.2	7.04	7.82
299	29.9	33.3	7.06	7.84
300	30.0	33.5	7.09	7.87
301	30.1	33.6	7.11	7.90
302	30.2	33.8	7.14	7.93
303	30.3	33.9	7.17	7.95
304	30.4	34.0	7.19	7.98
305	30.5	34.0	7.22	8.01
306	30.6	34.0	7.24	8.03
307	30.7	34.2	7.27	8.06
308	30.8	34.3	7.30	8.09
309	30.9	34.5	7.32	8.12
310	31.0	34.6	7.35	8.14
311	31.1	34.8	7.38	8.17
312	31.2	34.9	7.40	8.20
313	31.3	35.0	7.43	8.23
314	31.4	35.0	7.46	8.25
315	31.5	35.0	7.49	8.28
316	31.6	35.2	7.51	8.31
317	31.7	35.3	7.54	8.34
318	31.8	35.5	7.57	8.36
319	31.9	35.6	7.60	8.39
320	32.0	35.8	7.63	8.42
321	32.1	35.9	7.65	8.45
322	32.2	36.0	7.68	8.47
323	32.3	36.0	7.71	8.50
324	32.4	36.0	7.74	8.53
325	32.5	36.2	7.77	8.56
326	32.6	36.3	7.80	8.59
327	32.7	36.5	7.83	8.61
328	32.8	36.6	7.86	8.64
329	32.9	36.8	7.89	8.67
330	33.0	36.9	7.92	8.70
331	33.1	37.0	7.95	8.73
332	33.2	37.0	7.98	8.76
333	33.3	37.0	8.01	8.78
334	33.4	37.2	8.04	8.81
335	33.5	37.3	8.07	8.84
336	33.6	37.5	8.10	8.87
337	33.7	37.5	8.13	8.90
338	33.8	37.7	8.16	8.93
339	33.9	37.8	8.19	8.96
340	34.0	38.0	8.22	8.98
341	34.1	38.0	8.26	9.01
342	34.2	38.0	8.29	9.04
343	34.3	38.2	8.32	9.07
344	34.4	38.3	8.35	9.10
345	34.5	38.5	8.39	9.13
346	34.6	38.5	8.42	9.16
347	34.7	38.7	8.45	9.19
348	34.8	38.8	8.48	9.21
349	34.9	39.0	8.52	9.24
350	35.0	39.0	8.55	9.27
351	35.1	39.0	8.58	9.30
352	35.2	39.2	8.62	9.33
353	35.3	39.3	8.65	9.36
354	35.4	39.5	8.69	9.39
355	35.5	39.5	8.72	9.42
356	35.6	39.7	8.76	9.45
357	35.7	39.8	8.79	9.48
358	35.8	40.0	8.83	9.51
359	35.9	40.0	8.86	9.54
360	36.0	40.0	8.90	9.57
361	36.1	40.2	8.93	9.60
362	36.2	40.3	8.97	9.63
363	36.3	40.5	9.01	9.65
364	36.4	40.5	9.04	9.68

室内ユニット 合計容量	能力 (kW)		入力 (kW)	
	冷 房	暖 房	冷 房	暖 房
365	36.5	40.7	9.08	9.71
366	36.6	40.8	9.12	9.74
367	36.7	41.0	9.15	9.77
368	36.8	41.0	9.19	9.80
369	36.9	41.0	9.23	9.83
370	37.0	41.2	9.27	9.86
371	37.1	41.3	9.30	9.89
372	37.2	41.5	9.34	9.92
373	37.3	41.5	9.38	9.95
374	37.4	41.7	9.42	9.98
375	37.5	41.8	9.46	10.01
376	37.6	42.0	9.50	10.04
377	37.7	42.0	9.54	10.08
378	37.8	42.0	9.58	10.11
379	37.9	42.2	9.62	10.14
380	38.0	42.3	9.66	10.17
381	38.1	42.5	9.70	10.20
382	38.2	42.5	9.74	10.23
383	38.3	42.7	9.78	10.26
384	38.4	42.8	9.82	10.29
385	38.5	43.0	9.86	10.32
386	38.6	43.0	9.91	10.35
387	38.7	43.0	9.95	10.38
388	38.8	43.2	9.99	10.41
389	38.9	43.3	10.03	10.44
390	39.0	43.5	10.08	10.47
391	39.1	43.5	10.12	10.51
392	39.2	43.7	10.16	10.54
393	39.3	43.8	10.21	10.57
394	39.4	44.0	10.25	10.60
395	39.5	44.0	10.30	10.63
396	39.6	44.0	10.34	10.66
397	39.7	44.2	10.38	10.69
398	39.8	44.3	10.43	10.72
399	39.9	44.5	10.48	10.76
400	40.0	44.5	10.52	10.79
401	40.1	44.7	10.57	10.82
402	40.2	44.8	10.61	10.85
403	40.3	45.0	10.66	10.88
404	40.4	45.0	10.71	10.91
405	40.5	45.0	10.76	10.94
406	40.6	45.2	10.80	10.98
407	40.7	45.3	10.85	11.01
408	40.8	45.5	10.90	11.04
409	40.9	45.5	10.95	11.07
410	41.0	45.7	11.00	11.10
411	41.1	45.8	11.05	11.14
412	41.2	46.0	11.10	11.17
413	41.3	46.0	11.14	11.20
414	41.4	46.0	11.20	11.23
415	41.5	46.2	11.25	11.27
416	41.6	46.3	11.30	11.30
417	41.7	46.5	11.35	11.33
418	41.8	46.5	11.40	11.36
419	41.9	46.7	11.45	11.39
420	42.0	46.8	11.50	11.43
421	42.1	47.0	11.55	11.46
422	42.2	47.0	11.61	11.49
423	42.3	47.0	11.66	11.53
424	42.4	47.2	11.71	11.56
425	42.5	47.3	11.77	11.59
426	42.6	47.5	11.82	11.62
427	42.7	47.5	11.88	11.66
428	42.8	47.7	11.93	11.69
429	42.9	47.8	11.99	11.72
430	43.0	48.0	12.04	11.76
431	43.1	48.0	12.10	11.79
432	43.2	48.0	12.15	11.82
433	43.3	48.2	12.21	11.86
434	43.4	48.3	12.27	11.89

## 【PUHY-P450M-E】

室内ユニット 合計容量	能力 (kW)		入力 (kW)	
	冷房	暖房	冷房	暖房
435	43.5	48.5	12.32	11.92
436	43.6	48.5	12.38	11.96
437	43.7	48.7	12.44	11.99
438	43.8	48.8	12.50	12.02
439	43.9	49.0	12.56	12.06
440	44.0	49.0	12.62	12.09
441	44.1	49.0	12.67	12.12
442	44.2	49.2	12.73	12.16
443	44.3	49.3	12.79	12.19
444	44.4	49.5	12.85	12.22
445	44.5	49.5	12.92	12.26
446	44.6	49.7	12.98	12.29
447	44.7	49.8	13.04	12.33
448	44.8	50.0	13.10	12.36
449	44.9	50.0	13.16	12.40
450	45.0	50.0	13.42	12.43
451	45.0	50.0	13.42	12.43
452	45.0	50.0	13.43	12.42
453	45.1	50.0	13.43	12.41
454	45.1	50.0	13.43	12.41
455	45.1	50.0	13.43	12.40
456	45.1	50.0	13.43	12.39
457	45.1	50.0	13.43	12.39
458	45.1	50.0	13.43	12.38
459	45.2	50.0	13.43	12.37
460	45.2	50.0	13.43	12.37
461	45.2	50.0	13.43	12.36
462	45.2	50.0	13.43	12.35
463	45.2	50.0	13.43	12.35
464	45.3	50.0	13.43	12.34
465	45.3	50.0	13.43	12.33
466	45.3	50.0	13.43	12.33
467	45.3	50.0	13.43	12.32
468	45.3	50.0	13.43	12.31
469	45.4	50.0	13.44	12.31
470	45.4	50.0	13.44	12.30
471	45.4	50.0	13.44	12.29
472	45.4	50.0	13.44	12.29
473	45.4	50.0	13.44	12.28
474	45.4	50.0	13.44	12.27
475	45.5	50.0	13.44	12.27
476	45.5	50.0	13.44	12.26
477	45.5	50.0	13.44	12.25
478	45.5	50.0	13.44	12.25
479	45.5	50.0	13.44	12.24
480	45.6	50.1	13.44	12.23
481	45.6	50.1	13.44	12.23
482	45.6	50.1	13.44	12.22
483	45.6	50.1	13.44	12.21
484	45.6	50.1	13.44	12.21
485	45.6	50.1	13.44	12.20
486	45.7	50.1	13.45	12.19
487	45.7	50.1	13.45	12.19
488	45.7	50.1	13.45	12.18
489	45.7	50.1	13.45	12.17
490	45.7	50.1	13.45	12.17
491	45.8	50.1	13.45	12.16
492	45.8	50.1	13.45	12.15
493	45.8	50.1	13.45	12.15
494	45.8	50.1	13.45	12.14
495	45.8	50.1	13.45	12.13
496	45.8	50.1	13.45	12.13
497	45.9	50.1	13.45	12.12
498	45.9	50.1	13.45	12.11
499	45.9	50.1	13.45	12.11
500	45.9	50.1	13.45	12.10
501	45.9	50.1	13.45	12.09
502	46.0	50.1	13.45	12.09
503	46.0	50.1	13.46	12.08
504	46.0	50.1	13.46	12.07

室内ユニット 合計容量	能力 (kW)		入力 (kW)	
	冷房	暖房	冷房	暖房
505	46.0	50.1	13.46	12.07
506	46.0	50.1	13.46	12.06
507	46.1	50.1	13.46	12.05
508	46.1	50.1	13.46	12.05
509	46.1	50.1	13.46	12.04
510	46.1	50.1	13.46	12.03
511	46.1	50.1	13.46	12.03
512	46.1	50.1	13.46	12.02
513	46.2	50.1	13.46	12.01
514	46.2	50.1	13.46	12.01
515	46.2	50.1	13.46	12.00
516	46.2	50.1	13.46	11.99
517	46.2	50.1	13.46	11.99
518	46.3	50.1	13.46	11.98
519	46.3	50.1	13.46	11.97
520	46.3	50.1	13.47	11.96
521	46.3	50.1	13.47	11.96
522	46.3	50.1	13.47	11.95
523	46.3	50.1	13.47	11.94
524	46.4	50.1	13.47	11.94
525	46.4	50.1	13.47	11.93
526	46.4	50.1	13.47	11.92
527	46.4	50.1	13.47	11.92
528	46.4	50.1	13.47	11.91
529	46.5	50.1	13.47	11.90
530	46.5	50.1	13.47	11.90
531	46.5	50.1	13.47	11.89
532	46.5	50.1	13.47	11.88
533	46.5	50.1	13.47	11.88
534	46.5	50.1	13.47	11.87
535	46.6	50.1	13.47	11.86
536	46.6	50.1	13.47	11.86
537	46.6	50.1	13.48	11.85
538	46.6	50.1	13.48	11.84
539	46.6	50.2	13.48	11.84
540	46.7	50.2	13.48	11.83
541	46.7	50.2	13.48	11.82
542	46.7	50.2	13.48	11.82
543	46.7	50.2	13.48	11.81
544	46.7	50.2	13.48	11.80
545	46.8	50.2	13.48	11.80
546	46.8	50.2	13.48	11.79
547	46.8	50.2	13.48	11.78
548	46.8	50.2	13.48	11.78
549	46.8	50.2	13.48	11.77
550	46.8	50.2	13.48	11.76
551	46.9	50.2	13.48	11.76
552	46.9	50.2	13.48	11.75
553	46.9	50.2	13.48	11.74
554	46.9	50.2	13.49	11.74
555	46.9	50.2	13.49	11.73
556	47.0	50.2	13.49	11.72
557	47.0	50.2	13.49	11.72
558	47.0	50.2	13.49	11.71
559	47.0	50.2	13.49	11.70
560	47.0	50.2	13.49	11.70
561	47.0	50.2	13.49	11.69
562	47.1	50.2	13.49	11.68
563	47.1	50.2	13.49	11.68
564	47.1	50.2	13.49	11.67
565	47.1	50.2	13.49	11.66
566	47.1	50.2	13.49	11.66
567	47.2	50.2	13.49	11.65
568	47.2	50.2	13.49	11.64
569	47.2	50.2	13.49	11.64
570	47.2	50.2	13.49	11.63
571	47.2	50.2	13.50	11.62
572	47.3	50.2	13.50	11.62
573	47.3	50.2	13.50	11.61
574	47.3	50.2	13.50	11.60

室内ユニット 合計容量	能力 (kW)		入力 (kW)	
	冷房	暖房	冷房	暖房
575	47.3	50.2	13.50	11.60
576	47.3	50.2	13.50	11.59
577	47.3	50.2	13.50	11.58
578	47.4	50.2	13.50	11.58
579	47.4	50.2	13.50	11.57
580	47.4	50.2	13.50	11.56
581	47.4	50.2	13.50	11.56
582	47.4	50.2	13.50	11.55
583	47.5	50.2	13.50	11.54
584	47.5	50.2	13.50	11.54
585	47.5	50.2	13.50	11.53

b. 空気条件変化による補正

【PUHY-P335・P355・P400・P450M-E】

・冷房能力・入力補正

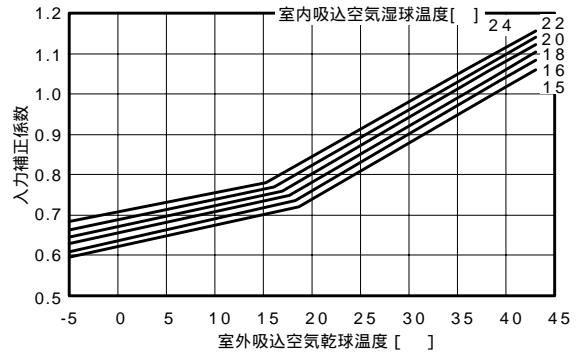
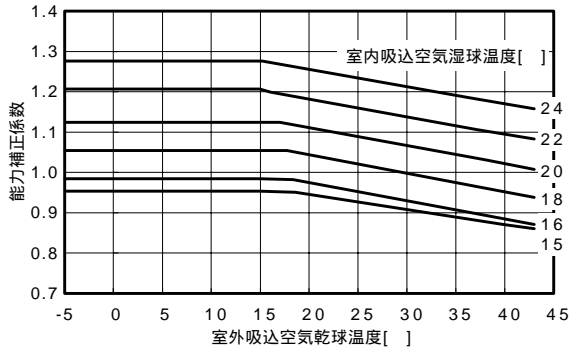

・暖房能力・入力補正

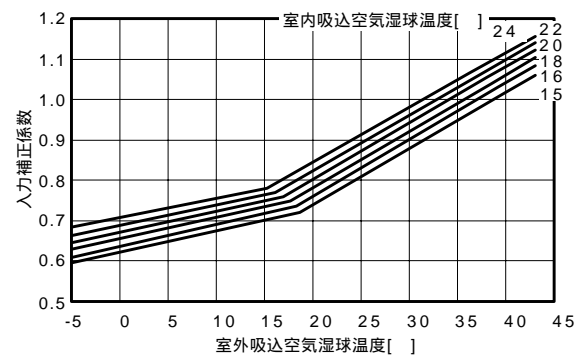
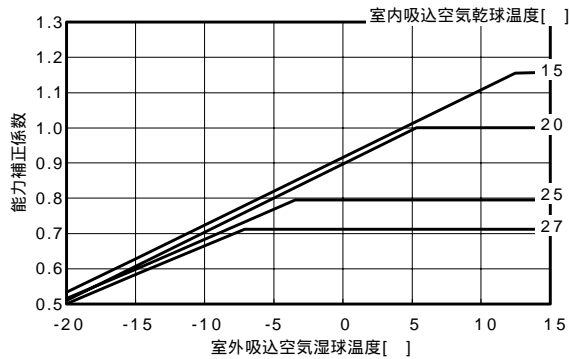

・冷房能力・入力補正 (オールフレッシュ)

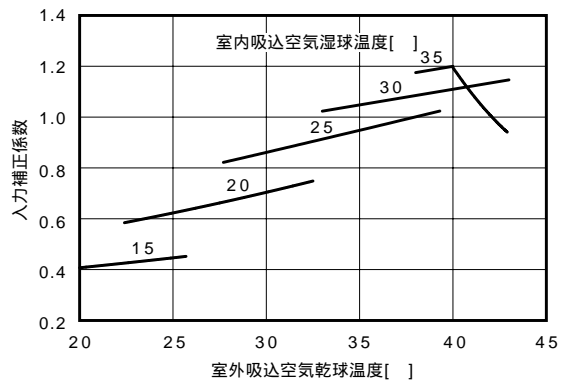
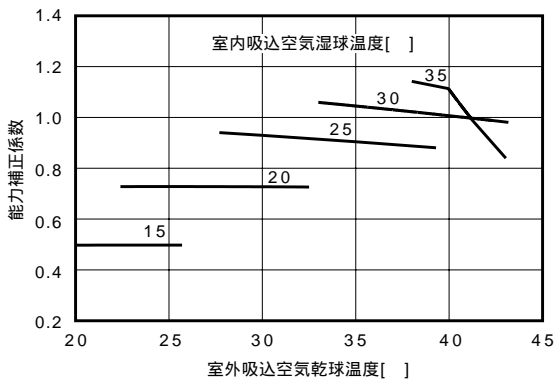

・暖房能力・入力補正 (オールフレッシュ)

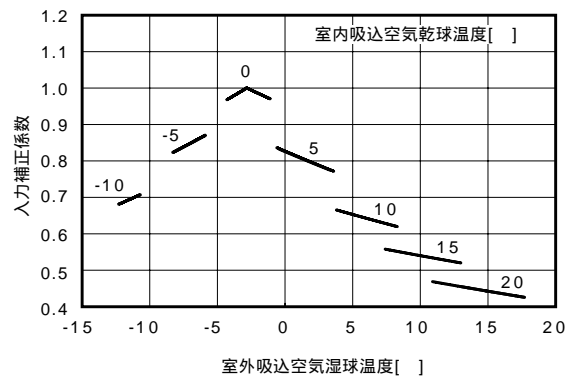
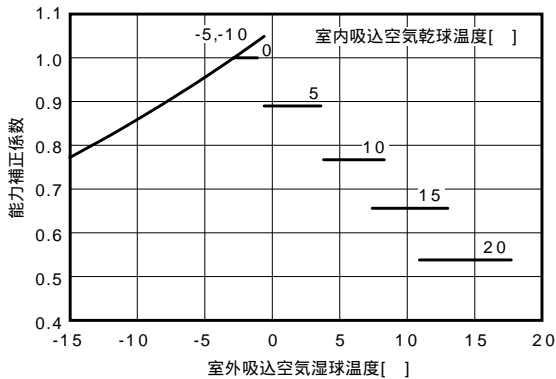

c. 冷媒配管長補正

【冷房能力補正係数】

【PUHY-P335M-E】

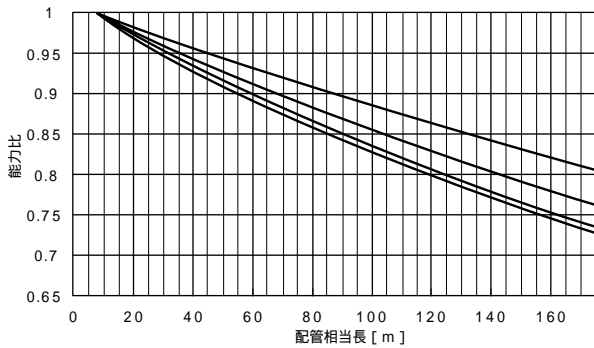

【PUHY-P355M-E】

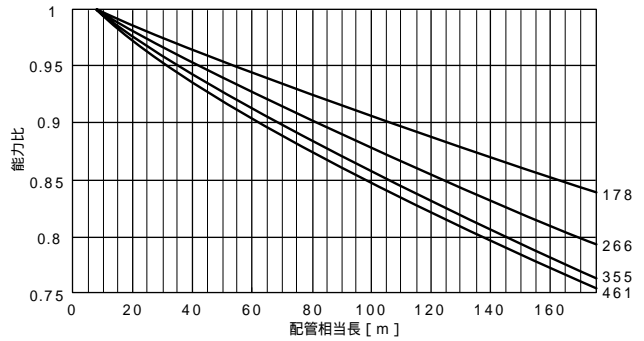

【PUHY-P400M-E】

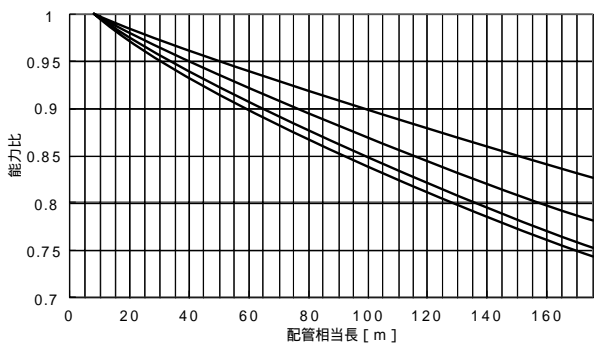

【PUHY-P450M-E】

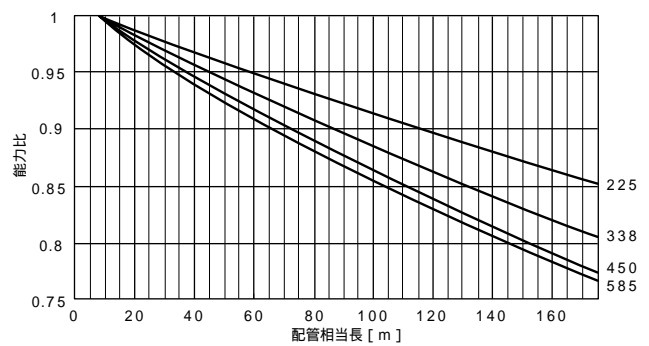

【暖房能力補正係数】

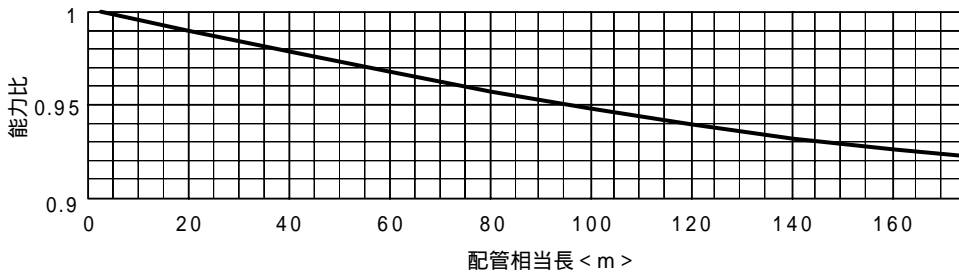

【配管相当長の求め方】

- (1) PUHY-P335M-E形 相当長 = (最遠室内ユニットまでの配管実長) + (0.42 × 配管途中のバンド数) m
- (2) PUHY-P355M-E形 相当長 = (最遠室内ユニットまでの配管実長) + (0.47 × 配管途中のバンド数) m
- (3) PUHY-P400M-E形 相当長 = (最遠室内ユニットまでの配管実長) + (0.47 × 配管途中のバンド数) m
- (4) PUHY-P450M-E形 相当長 = (最遠室内ユニットまでの配管実長) + (0.50 × 配管途中のバンド数) m

d. 霜取補正

室外吸込空気温度 < 湿球温度 >		6	4	2	1	0	-2	-4	-6	-8	-10
霜取補正係数	P335 P355形	1.0	0.93	0.82	0.80	0.82	0.86	0.90	0.90	0.95	0.95
	P400形	1.0	0.93	0.85	0.83	0.84	0.86	0.90	0.90	0.95	0.95
	P450形	1.0	0.95	0.90	0.87	0.88	0.89	0.90	0.95	0.95	0.95

P500~P730M-E形  
a. 標準能力表  
【PUHY-P500M-E】

室内ユニット 合計容量	能力 (kW)		入力 (kW)	
	冷房	暖房	冷房	暖房
250	25.0	28.0	6.49	6.81
251	25.1	28.0	6.51	6.84
252	25.2	28.0	6.54	6.86
253	25.3	28.2	6.56	6.89
254	25.4	28.3	6.58	6.91
255	25.5	28.5	6.61	6.94
256	25.6	28.6	6.63	6.96
257	25.7	28.8	6.66	6.99
258	25.8	28.9	6.68	7.01
259	25.9	29.0	6.70	7.04
260	26.0	29.0	6.73	7.06
261	26.1	29.0	6.75	7.09
262	26.2	29.2	6.78	7.11
263	26.3	29.3	6.80	7.14
264	26.4	29.5	6.82	7.16
265	26.5	29.6	6.85	7.19
266	26.6	29.8	6.87	7.21
267	26.7	30.0	6.90	7.24
268	26.8	30.0	6.92	7.26
269	26.9	30.0	6.94	7.29
270	27.0	30.0	6.97	7.31
271	27.1	30.2	6.99	7.34
272	27.2	30.3	7.02	7.36
273	27.3	30.5	7.04	7.39
274	27.4	30.6	7.06	7.41
275	27.5	30.8	7.09	7.44
276	27.6	30.9	7.11	7.47
277	27.7	31.0	7.14	7.49
278	27.8	31.0	7.16	7.52
279	27.9	31.0	7.18	7.54
280	28.0	31.2	7.21	7.57
281	28.1	31.3	7.23	7.59
282	28.2	31.5	7.25	7.62
283	28.3	31.6	7.28	7.64
284	28.4	31.8	7.30	7.67
285	28.5	31.9	7.33	7.70
286	28.6	32.0	7.35	7.72
287	28.7	32.0	7.37	7.75
288	28.8	32.0	7.40	7.77
289	28.9	32.2	7.42	7.80
290	29.0	32.3	7.45	7.82
291	29.1	32.5	7.47	7.85
292	29.2	32.6	7.49	7.88
293	29.3	32.8	7.52	7.90
294	29.4	32.9	7.54	7.93
295	29.5	33.0	7.57	7.95
296	29.6	33.0	7.59	7.98
297	29.7	33.0	7.61	8.01
298	29.8	33.2	7.64	8.03
299	29.9	33.3	7.66	8.06
300	30.0	33.5	7.69	8.08
301	30.1	33.6	7.71	8.11
302	30.2	33.8	7.73	8.14
303	30.3	33.9	7.76	8.16
304	30.4	34.0	7.78	8.19
305	30.5	34.0	7.81	8.21
306	30.6	34.0	7.83	8.24
307	30.7	34.2	7.85	8.27
308	30.8	34.3	7.88	8.29
309	30.9	34.5	7.90	8.32
310	31.0	34.6	7.93	8.35
311	31.1	34.8	7.95	8.37
312	31.2	34.9	7.97	8.40
313	31.3	35.0	8.00	8.42
314	31.4	35.0	8.02	8.45
315	31.5	35.0	8.05	8.48
316	31.6	35.2	8.07	8.50
317	31.7	35.3	8.10	8.53
318	31.8	35.5	8.12	8.56
319	31.9	35.6	8.14	8.58

室内ユニット 合計容量	能力 (kW)		入力 (kW)	
	冷房	暖房	冷房	暖房
320	32.0	35.8	8.17	8.61
321	32.1	35.9	8.19	8.64
322	32.2	36.0	8.22	8.66
323	32.3	36.0	8.24	8.69
324	32.4	36.0	8.27	8.72
325	32.5	36.2	8.29	8.74
326	32.6	36.3	8.31	8.77
327	32.7	36.5	8.34	8.80
328	32.8	36.6	8.36	8.82
329	32.9	36.8	8.39	8.85
330	33.0	36.9	8.41	8.88
331	33.1	37.0	8.44	8.90
332	33.2	37.0	8.46	8.93
333	33.3	37.0	8.49	8.96
334	33.4	37.2	8.51	8.99
335	33.5	37.3	8.54	9.01
336	33.6	37.5	8.56	9.04
337	33.7	37.5	8.59	9.07
338	33.8	37.7	8.61	9.09
339	33.9	37.8	8.64	9.12
340	34.0	38.0	8.66	9.15
341	34.1	38.0	8.69	9.17
342	34.2	38.0	8.71	9.20
343	34.3	38.2	8.74	9.23
344	34.4	38.3	8.76	9.26
345	34.5	38.5	8.79	9.28
346	34.6	38.5	8.81	9.31
347	34.7	38.7	8.84	9.34
348	34.8	38.8	8.86	9.37
349	34.9	39.0	8.89	9.39
350	35.0	39.0	8.91	9.42
351	35.1	39.0	8.94	9.45
352	35.2	39.2	8.96	9.48
353	35.3	39.3	8.99	9.50
354	35.4	39.5	9.01	9.53
355	35.5	39.5	9.04	9.56
356	35.6	39.7	9.07	9.59
357	35.7	39.8	9.09	9.61
358	35.8	40.0	9.12	9.64
359	35.9	40.0	9.14	9.67
360	36.0	40.0	9.17	9.70
361	36.1	40.2	9.19	9.72
362	36.2	40.3	9.22	9.75
363	36.3	40.5	9.25	9.78
364	36.4	40.5	9.27	9.81
365	36.5	40.7	9.30	9.84
366	36.6	40.8	9.32	9.86
367	36.7	41.0	9.35	9.89
368	36.8	41.0	9.38	9.92
369	36.9	41.0	9.40	9.95
370	37.0	41.2	9.43	9.97
371	37.1	41.3	9.46	10.00
372	37.2	41.5	9.48	10.03
373	37.3	41.5	9.51	10.06
374	37.4	41.7	9.54	10.09
375	37.5	41.8	9.56	10.12
376	37.6	42.0	9.59	10.14
377	37.7	42.0	9.62	10.17
378	37.8	42.0	9.64	10.20
379	37.9	42.2	9.67	10.23
380	38.0	42.3	9.70	10.26
381	38.1	42.5	9.72	10.28
382	38.2	42.5	9.75	10.31
383	38.3	42.7	9.78	10.34
384	38.4	42.8	9.81	10.37
385	38.5	43.0	9.83	10.40
386	38.6	43.0	9.86	10.43
387	38.7	43.0	9.89	10.45
388	38.8	43.2	9.92	10.48
389	38.9	43.3	9.94	10.51

室内ユニット 合計容量	能力 (kW)		入力 (kW)	
	冷房	暖房	冷房	暖房
390	39.0	43.5	9.97	10.54
391	39.1	43.5	10.00	10.57
392	39.2	43.7	10.03	10.60
393	39.3	43.8	10.05	10.63
394	39.4	44.0	10.08	10.65
395	39.5	44.0	10.11	10.68
396	39.6	44.0	10.14	10.71
397	39.7	44.2	10.17	10.74
398	39.8	44.3	10.20	10.77
399	39.9	44.5	10.22	10.80
400	40.0	44.5	10.25	10.83
401	40.1	44.7	10.28	10.86
402	40.2	44.8	10.31	10.89
403	40.3	45.0	10.34	10.91
404	40.4	45.0	10.37	10.94
405	40.5	45.0	10.40	10.97
406	40.6	45.2	10.42	11.00
407	40.7	45.3	10.45	11.03
408	40.8	45.5	10.48	11.06
409	40.9	45.5	10.51	11.09
410	41.0	45.7	10.54	11.12
411	41.1	45.8	10.57	11.15
412	41.2	46.0	10.60	11.18
413	41.3	46.0	10.63	11.21
414	41.4	46.0	10.66	11.23
415	41.5	46.2	10.69	11.26
416	41.6	46.3	10.72	11.29
417	41.7	46.5	10.75	11.32
418	41.8	46.5	10.78	11.35
419	41.9	46.7	10.81	11.38
420	42.0	46.8	10.84	11.41
421	42.1	47.0	10.87	11.44
422	42.2	47.0	10.90	11.47
423	42.3	47.0	10.93	11.50
424	42.4	47.2	10.96	11.53
425	42.5	47.3	10.99	11.56
426	42.6	47.5	11.02	11.59
427	42.7	47.5	11.05	11.62
428	42.8	47.7	11.08	11.65
429	42.9	47.8	11.11	11.68
430	43.0	48.0	11.15	11.71
431	43.1	48.0	11.18	11.74
432	43.2	48.0	11.21	11.77
433	43.3	48.2	11.24	11.80
434	43.4	48.3	11.27	11.83
435	43.5	48.5	11.30	11.86
436	43.6	48.5	11.33	11.89
437	43.7	48.7	11.37	11.92
438	43.8	48.8	11.40	11.95
439	43.9	49.0	11.43	11.98
440	44.0	49.0	11.46	12.01
441	44.1	49.0	11.49	12.04
442	44.2	49.2	11.53	12.07
443	44.3	49.3	11.56	12.10
444	44.4	49.5	11.59	12.13
445	44.5	49.5	11.62	12.16
446	44.6	49.7	11.66	12.19
447	44.7	49.8	11.69	12.22
448	44.8	50.0	11.72	12.25
449	44.9	50.0	11.76	12.28
450	45.0	50.0	11.79	12.31
451	45.1	50.2	11.82	12.34
452	45.2	50.3	11.86	12.37
453	45.3	50.5	11.89	12.40
454	45.4	50.5	11.92	12.43
455	45.5	50.7	11.96	12.46
456	45.6	50.8	11.99	12.49
457	45.7	51.0	12.03	12.52
458	45.8	51.0	12.06	12.55
459	45.9	51.0	12.09	12.58

## 【PUHY-P500M-E】

室内ユニット 合計容量	能力 (kW)		入力 (kW)	
	冷房	暖房	冷房	暖房
460	46.0	51.2	12.13	12.61
461	46.1	51.3	12.16	12.64
462	46.2	51.5	12.20	12.67
463	46.3	51.5	12.23	12.70
464	46.4	51.7	12.27	12.73
465	46.5	51.8	12.30	12.76
466	46.6	52.0	12.34	12.80
467	46.7	52.0	12.37	12.83
468	46.8	52.0	12.41	12.86
469	46.9	52.2	12.44	12.89
470	47.0	52.3	12.48	12.92
471	47.1	52.5	12.51	12.95
472	47.2	52.5	12.55	12.98
473	47.3	52.7	12.59	13.01
474	47.4	52.8	12.62	13.04
475	47.5	53.0	12.66	13.07
476	47.6	53.0	12.69	13.11
477	47.7	53.0	12.73	13.14
478	47.8	53.2	12.77	13.17
479	47.9	53.3	12.80	13.20
480	48.0	53.5	12.84	13.23
481	48.1	53.5	12.88	13.26
482	48.2	53.7	12.92	13.29
483	48.3	53.8	12.95	13.32
484	48.4	54.0	12.99	13.35
485	48.5	54.0	13.03	13.39
486	48.6	54.0	13.07	13.42
487	48.7	54.2	13.10	13.45
488	48.8	54.3	13.14	13.48
489	48.9	54.5	13.18	13.51
490	49.0	54.5	13.22	13.54
491	49.1	54.7	13.26	13.57
492	49.2	54.8	13.29	13.61
493	49.3	55.0	13.33	13.64
494	49.4	55.0	13.37	13.67
495	49.5	55.0	13.41	13.70
496	49.6	55.2	13.45	13.73
497	49.7	55.3	13.49	13.76
498	49.8	55.5	13.53	13.80
499	49.9	55.5	13.57	13.83
500	50.0	56.0	13.61	13.86
501	50.0	56.0	13.60	13.86
502	50.1	56.0	13.60	13.85
503	50.1	56.0	13.59	13.84
504	50.1	56.0	13.59	13.84
505	50.1	56.0	13.58	13.83
506	50.2	56.0	13.58	13.83
507	50.2	56.0	13.58	13.82
508	50.2	56.0	13.57	13.81
509	50.2	56.0	13.57	13.81
510	50.3	56.0	13.56	13.80
511	50.3	56.0	13.56	13.79
512	50.3	56.0	13.55	13.79
513	50.3	56.0	13.55	13.78
514	50.4	56.0	13.54	13.78
515	50.4	56.0	13.54	13.77
516	50.4	56.0	13.54	13.76
517	50.5	56.0	13.53	13.76
518	50.5	56.0	13.53	13.75
519	50.5	56.0	13.52	13.75
520	50.5	56.0	13.52	13.74
521	50.6	56.0	13.51	13.73
522	50.6	56.0	13.51	13.73
523	50.6	56.0	13.50	13.72
524	50.6	56.0	13.50	13.71
525	50.7	56.0	13.50	13.71
526	50.7	56.0	13.49	13.70
527	50.7	56.0	13.49	13.70
528	50.8	56.0	13.48	13.69
529	50.8	56.0	13.48	13.68

室内ユニット 合計容量	能力 (kW)		入力 (kW)	
	冷房	暖房	冷房	暖房
530	50.8	56.0	13.47	13.68
531	50.8	56.0	13.47	13.67
532	50.9	56.0	13.46	13.67
533	50.9	56.0	13.46	13.66
534	50.9	56.0	13.46	13.65
535	50.9	56.0	13.45	13.65
536	51.0	56.0	13.45	13.64
537	51.0	56.0	13.44	13.63
538	51.0	56.0	13.44	13.63
539	51.0	56.0	13.43	13.62
540	51.1	56.0	13.43	13.62
541	51.1	56.0	13.42	13.61
542	51.1	56.1	13.42	13.60
543	51.2	56.1	13.42	13.60
544	51.2	56.1	13.41	13.59
545	51.2	56.1	13.41	13.59
546	51.2	56.1	13.40	13.58
547	51.3	56.1	13.40	13.57
548	51.3	56.1	13.39	13.57
549	51.3	56.1	13.39	13.56
550	51.3	56.1	13.39	13.55
551	51.4	56.1	13.38	13.55
552	51.4	56.1	13.38	13.54
553	51.4	56.1	13.37	13.54
554	51.4	56.1	13.37	13.53
555	51.5	56.1	13.36	13.52
556	51.5	56.1	13.36	13.52
557	51.5	56.1	13.35	13.51
558	51.6	56.1	13.35	13.51
559	51.6	56.1	13.35	13.50
560	51.6	56.1	13.34	13.49
561	51.6	56.1	13.34	13.49
562	51.7	56.1	13.33	13.48
563	51.7	56.1	13.33	13.47
564	51.7	56.1	13.32	13.47
565	51.7	56.1	13.32	13.46
566	51.8	56.1	13.31	13.46
567	51.8	56.1	13.31	13.45
568	51.8	56.1	13.31	13.44
569	51.8	56.1	13.30	13.44
570	51.9	56.1	13.30	13.43
571	51.9	56.1	13.29	13.43
572	51.9	56.1	13.29	13.42
573	52.0	56.1	13.28	13.41
574	52.0	56.1	13.28	13.41
575	52.0	56.1	13.27	13.40
576	52.0	56.1	13.27	13.39
577	52.1	56.1	13.27	13.39
578	52.1	56.1	13.26	13.38
579	52.1	56.1	13.26	13.38
580	52.1	56.1	13.25	13.37
581	52.2	56.1	13.25	13.36
582	52.2	56.1	13.24	13.36
583	52.2	56.1	13.24	13.35
584	52.3	56.1	13.23	13.35
585	52.3	56.1	13.23	13.34
586	52.3	56.1	13.23	13.33
587	52.3	56.1	13.22	13.33
588	52.4	56.1	13.22	13.32
589	52.4	56.1	13.21	13.31
590	52.4	56.1	13.21	13.31
591	52.4	56.1	13.20	13.30
592	52.5	56.1	13.20	13.30
593	52.5	56.1	13.19	13.29
594	52.5	56.1	13.19	13.28
595	52.5	56.1	13.19	13.28
596	52.6	56.1	13.18	13.27
597	52.6	56.1	13.18	13.27
598	52.6	56.1	13.17	13.26
599	52.7	56.1	13.17	13.25

室内ユニット 合計容量	能力 (kW)		入力 (kW)	
	冷房	暖房	冷房	暖房
600	52.7	56.1	13.16	13.25
601	52.7	56.1	13.16	13.24
602	52.7	56.1	13.15	13.23
603	52.8	56.1	13.15	13.23
604	52.8	56.1	13.15	13.22
605	52.8	56.1	13.14	13.22
606	52.8	56.1	13.14	13.21
607	52.9	56.1	13.13	13.20
608	52.9	56.1	13.13	13.20
609	52.9	56.1	13.12	13.19
610	52.9	56.1	13.12	13.19
611	53.0	56.1	13.12	13.18
612	53.0	56.1	13.11	13.17
613	53.0	56.1	13.11	13.17
614	53.1	56.1	13.10	13.16
615	53.1	56.1	13.10	13.15
616	53.1	56.1	13.09	13.15
617	53.1	56.1	13.09	13.14
618	53.2	56.1	13.08	13.14
619	53.2	56.1	13.08	13.13
620	53.2	56.1	13.08	13.12
621	53.2	56.1	13.07	13.12
622	53.3	56.1	13.07	13.11
623	53.3	56.1	13.06	13.11
624	53.3	56.1	13.06	13.10
625	53.4	56.2	13.05	13.09
626	53.4	56.2	13.05	13.09
627	53.4	56.2	13.04	13.08
628	53.4	56.2	13.04	13.07
629	53.5	56.2	13.04	13.07
630	53.5	56.2	13.03	13.06
631	53.5	56.2	13.03	13.06
632	53.5	56.2	13.02	13.05
633	53.6	56.2	13.02	13.04
634	53.6	56.2	13.01	13.04
635	53.6	56.2	13.01	13.03
636	53.6	56.2	13.00	13.03
637	53.7	56.2	13.00	13.02
638	53.7	56.2	13.00	13.01
639	53.7	56.2	12.99	13.01
640	53.8	56.2	12.99	13.00
641	53.8	56.2	12.98	12.99
642	53.8	56.2	12.98	12.99
643	53.8	56.2	12.97	12.98
644	53.9	56.2	12.97	12.98
645	53.9	56.2	12.96	12.97
646	53.9	56.2	12.96	12.96
647	53.9	56.2	12.96	12.96
648	54.0	56.2	12.95	12.95
649	54.0	56.2	12.95	12.95
650	54.0	56.2	12.94	12.94

# 【PUHY-P560M-E】

室内ユニット 合計容量	能力 (kW)		入力 (kW)	
	冷房	暖房	冷房	暖房
280	28.0	31.2	7.15	8.06
281	28.1	31.3	7.18	8.09
282	28.2	31.5	7.20	8.11
283	28.3	31.6	7.23	8.14
284	28.4	31.8	7.26	8.17
285	28.5	31.9	7.29	8.20
286	28.6	32.0	7.32	8.22
287	28.7	32.0	7.35	8.25
288	28.8	32.0	7.37	8.28
289	28.9	32.2	7.40	8.31
290	29.0	32.3	7.43	8.34
291	29.1	32.5	7.46	8.36
292	29.2	32.6	7.49	8.39
293	29.3	32.8	7.52	8.42
294	29.4	32.9	7.54	8.45
295	29.5	33.0	7.57	8.47
296	29.6	33.0	7.60	8.50
297	29.7	33.0	7.63	8.53
298	29.8	33.2	7.66	8.56
299	29.9	33.3	7.69	8.58
300	30.0	33.5	7.71	8.61
301	30.1	33.6	7.74	8.64
302	30.2	33.8	7.77	8.67
303	30.3	33.9	7.80	8.70
304	30.4	34.0	7.83	8.72
305	30.5	34.0	7.86	8.75
306	30.6	34.0	7.89	8.78
307	30.7	34.2	7.91	8.81
308	30.8	34.3	7.94	8.83
309	30.9	34.5	7.97	8.86
310	31.0	34.6	8.00	8.89
311	31.1	34.8	8.03	8.92
312	31.2	34.9	8.06	8.95
313	31.3	35.0	8.09	8.97
314	31.4	35.0	8.12	9.00
315	31.5	35.0	8.14	9.03
316	31.6	35.2	8.17	9.06
317	31.7	35.3	8.20	9.08
318	31.8	35.5	8.23	9.11
319	31.9	35.6	8.26	9.14
320	32.0	35.8	8.29	9.17
321	32.1	35.9	8.32	9.20
322	32.2	36.0	8.34	9.22
323	32.3	36.0	8.37	9.25
324	32.4	36.0	8.40	9.28
325	32.5	36.2	8.43	9.31
326	32.6	36.3	8.46	9.33
327	32.7	36.5	8.49	9.36
328	32.8	36.6	8.52	9.39
329	32.9	36.8	8.55	9.42
330	33.0	36.9	8.58	9.45
331	33.1	37.0	8.60	9.47
332	33.2	37.0	8.63	9.50
333	33.3	37.0	8.66	9.53
334	33.4	37.2	8.69	9.56
335	33.5	37.3	8.72	9.59
336	33.6	37.5	8.75	9.61
337	33.7	37.5	8.78	9.64
338	33.8	37.7	8.81	9.67
339	33.9	37.8	8.84	9.70
340	34.0	38.0	8.87	9.73
341	34.1	38.0	8.89	9.75
342	34.2	38.0	8.92	9.78
343	34.3	38.2	8.95	9.81
344	34.4	38.3	8.98	9.84
345	34.5	38.5	9.01	9.86
346	34.6	38.5	9.04	9.89
347	34.7	38.7	9.07	9.92
348	34.8	38.8	9.10	9.95
349	34.9	39.0	9.13	9.98

室内ユニット 合計容量	能力 (kW)		入力 (kW)	
	冷房	暖房	冷房	暖房
350	35.0	39.0	9.16	10.00
351	35.1	39.0	9.19	10.03
352	35.2	39.2	9.21	10.06
353	35.3	39.3	9.24	10.09
354	35.4	39.5	9.27	10.12
355	35.5	39.5	9.30	10.14
356	35.6	39.7	9.33	10.17
357	35.7	39.8	9.36	10.20
358	35.8	40.0	9.39	10.23
359	35.9	40.0	9.42	10.26
360	36.0	40.0	9.45	10.28
361	36.1	40.2	9.48	10.31
362	36.2	40.3	9.51	10.34
363	36.3	40.5	9.54	10.37
364	36.4	40.5	9.57	10.40
365	36.5	40.7	9.60	10.42
366	36.6	40.8	9.62	10.45
367	36.7	41.0	9.65	10.48
368	36.8	41.0	9.68	10.51
369	36.9	41.0	9.71	10.54
370	37.0	41.2	9.74	10.56
371	37.1	41.3	9.77	10.59
372	37.2	41.5	9.80	10.62
373	37.3	41.5	9.83	10.65
374	37.4	41.7	9.86	10.68
375	37.5	41.8	9.89	10.71
376	37.6	42.0	9.92	10.73
377	37.7	42.0	9.95	10.76
378	37.8	42.0	9.98	10.79
379	37.9	42.2	10.01	10.82
380	38.0	42.3	10.04	10.85
381	38.1	42.5	10.07	10.87
382	38.2	42.5	10.10	10.90
383	38.3	42.7	10.13	10.93
384	38.4	42.8	10.16	10.96
385	38.5	43.0	10.19	10.99
386	38.6	43.0	10.21	11.01
387	38.7	43.0	10.24	11.04
388	38.8	43.2	10.27	11.07
389	38.9	43.3	10.30	11.10
390	39.0	43.5	10.33	11.13
391	39.1	43.5	10.36	11.16
392	39.2	43.7	10.39	11.18
393	39.3	43.8	10.42	11.21
394	39.4	44.0	10.45	11.24
395	39.5	44.0	10.48	11.27
396	39.6	44.0	10.51	11.30
397	39.7	44.2	10.54	11.32
398	39.8	44.3	10.57	11.35
399	39.9	44.5	10.60	11.38
400	40.0	44.5	10.63	11.41
401	40.1	44.7	10.66	11.44
402	40.2	44.8	10.69	11.47
403	40.3	45.0	10.72	11.49
404	40.4	45.0	10.75	11.52
405	40.5	45.0	10.78	11.55
406	40.6	45.2	10.81	11.58
407	40.7	45.3	10.84	11.61
408	40.8	45.5	10.87	11.63
409	40.9	45.5	10.90	11.66
410	41.0	45.7	10.93	11.69
411	41.1	45.8	10.96	11.72
412	41.2	46.0	10.99	11.75
413	41.3	46.0	11.02	11.78
414	41.4	46.0	11.05	11.80
415	41.5	46.2	11.08	11.83
416	41.6	46.3	11.11	11.86
417	41.7	46.5	11.14	11.89
418	41.8	46.5	11.17	11.92
419	41.9	46.7	11.20	11.95

室内ユニット 合計容量	能力 (kW)		入力 (kW)	
	冷房	暖房	冷房	暖房
420	42.0	46.8	11.23	11.97
421	42.1	47.0	11.26	12.00
422	42.2	47.0	11.29	12.03
423	42.3	47.0	11.32	12.06
424	42.4	47.2	11.35	12.09
425	42.5	47.3	11.38	12.12
426	42.6	47.5	11.41	12.14
427	42.7	47.5	11.44	12.17
428	42.8	47.7	11.47	12.20
429	42.9	47.8	11.50	12.23
430	43.0	48.0	11.53	12.26
431	43.1	48.0	11.56	12.29
432	43.2	48.0	11.59	12.31
433	43.3	48.2	11.62	12.34
434	43.4	48.3	11.65	12.37
435	43.5	48.5	11.68	12.40
436	43.6	48.5	11.71	12.43
437	43.7	48.7	11.74	12.46
438	43.8	48.8	11.77	12.48
439	43.9	49.0	11.80	12.51
440	44.0	49.0	11.84	12.54
441	44.1	49.0	11.87	12.57
442	44.2	49.2	11.90	12.60
443	44.3	49.3	11.93	12.63
444	44.4	49.5	11.96	12.65
445	44.5	49.5	11.99	12.68
446	44.6	49.7	12.02	12.71
447	44.7	49.8	12.05	12.74
448	44.8	50.0	12.08	12.77
449	44.9	50.0	12.11	12.80
450	45.0	50.0	12.14	12.83
451	45.1	50.2	12.17	12.85
452	45.2	50.3	12.20	12.88
453	45.3	50.5	12.23	12.91
454	45.4	50.5	12.26	12.94
455	45.5	50.7	12.29	12.97
456	45.6	50.8	12.32	13.00
457	45.7	51.0	12.35	13.02
458	45.8	51.0	12.38	13.05
459	45.9	51.0	12.41	13.08
460	46.0	51.2	12.45	13.11
461	46.1	51.3	12.48	13.14
462	46.2	51.5	12.51	13.17
463	46.3	51.5	12.54	13.20
464	46.4	51.7	12.57	13.22
465	46.5	51.8	12.60	13.25
466	46.6	52.0	12.63	13.28
467	46.7	52.0	12.66	13.31
468	46.8	52.0	12.69	13.34
469	46.9	52.2	12.72	13.37
470	47.0	52.3	12.75	13.40
471	47.1	52.5	12.78	13.42
472	47.2	52.5	12.81	13.45
473	47.3	52.7	12.84	13.48
474	47.4	52.8	12.88	13.51
475	47.5	53.0	12.91	13.54
476	47.6	53.0	12.94	13.57
477	47.7	53.0	12.97	13.60
478	47.8	53.2	13.00	13.62
479	47.9	53.3	13.03	13.65
480	48.0	53.5	13.06	13.68
481	48.1	53.5	13.09	13.71
482	48.2	53.7	13.12	13.74
483	48.3	53.8	13.15	13.77
484	48.4	54.0	13.18	13.80
485	48.5	54.0	13.22	13.82
486	48.6	54.0	13.25	13.85
487	48.7	54.2	13.28	13.88
488	48.8	54.3	13.31	13.91
489	48.9	54.5	13.34	13.94

【PUHY-P560M-E】

室内ユニット 合計容量	能力 (kW)		入力 (kW)	
	冷房	暖房	冷房	暖房
490	49.0	54.5	13.37	13.97
491	49.1	54.7	13.40	14.00
492	49.2	54.8	13.43	14.02
493	49.3	55.0	13.46	14.05
494	49.4	55.0	13.49	14.08
495	49.5	55.0	13.53	14.11
496	49.6	55.2	13.56	14.14
497	49.7	55.3	13.59	14.17
498	49.8	55.5	13.62	14.20
499	49.9	55.5	13.65	14.23
500	50.0	55.7	13.68	14.25
501	50.1	55.8	13.71	14.28
502	50.2	56.0	13.74	14.31
503	50.3	56.0	13.77	14.34
504	50.4	56.0	13.81	14.37
505	50.5	56.2	13.84	14.40
506	50.6	56.3	13.87	14.43
507	50.7	56.5	13.90	14.45
508	50.8	56.5	13.93	14.48
509	50.9	56.7	13.96	14.51
510	51.0	56.8	13.99	14.54
511	51.1	57.0	14.02	14.57
512	51.2	57.0	14.06	14.60
513	51.3	57.0	14.09	14.63
514	51.4	57.2	14.12	14.66
515	51.5	57.3	14.15	14.68
516	51.6	57.5	14.18	14.71
517	51.7	57.5	14.21	14.74
518	51.8	57.7	14.24	14.77
519	51.9	57.8	14.28	14.80
520	52.0	58.0	14.31	14.83
521	52.1	58.0	14.34	14.86
522	52.2	58.0	14.37	14.89
523	52.3	58.2	14.40	14.92
524	52.4	58.3	14.43	14.94
525	52.5	58.5	14.46	14.97
526	52.6	58.5	14.50	15.00
527	52.7	58.7	14.53	15.03
528	52.8	58.8	14.56	15.06
529	52.9	59.0	14.59	15.09
530	53.0	59.0	14.62	15.12
531	53.1	59.0	14.65	15.15
532	53.2	59.2	14.68	15.17
533	53.3	59.3	14.72	15.20
534	53.4	59.5	14.75	15.23
535	53.5	59.5	14.78	15.26
536	53.6	59.7	14.81	15.29
537	53.7	59.8	14.84	15.32
538	53.8	60.0	14.87	15.35
539	53.9	60.0	14.91	15.38
540	54.0	60.0	14.94	15.41
541	54.1	60.2	14.97	15.43
542	54.2	60.3	15.00	15.46
543	54.3	60.5	15.03	15.49
544	54.4	60.5	15.07	15.52
545	54.5	60.7	15.10	15.55
546	54.6	60.8	15.13	15.58
547	54.7	61.0	15.16	15.61
548	54.8	61.0	15.19	15.64
549	54.9	61.0	15.22	15.67
550	55.0	61.2	15.26	15.69
551	55.1	61.3	15.29	15.72
552	55.2	61.5	15.32	15.75
553	55.3	61.5	15.35	15.78
554	55.4	61.7	15.38	15.81
555	55.5	61.8	15.42	15.84
556	55.6	62.0	15.45	15.87
557	55.7	62.0	15.48	15.90
558	55.8	62.0	15.51	15.93
559	55.9	62.2	15.54	15.95

室内ユニット 合計容量	能力 (kW)		入力 (kW)	
	冷房	暖房	冷房	暖房
560	56.0	63.0	15.59	15.89
561	56.0	63.0	15.59	15.89
562	56.1	63.0	15.60	15.88
563	56.1	63.0	15.60	15.87
564	56.1	63.0	15.60	15.87
565	56.1	63.0	15.60	15.86
566	56.2	63.0	15.60	15.85
567	56.2	63.0	15.60	15.85
568	56.2	63.0	15.60	15.84
569	56.2	63.0	15.60	15.83
570	56.3	63.0	15.60	15.83
571	56.3	63.0	15.60	15.82
572	56.3	63.0	15.60	15.81
573	56.3	63.0	15.60	15.81
574	56.4	63.0	15.60	15.80
575	56.4	63.0	15.60	15.79
576	56.4	63.0	15.60	15.79
577	56.5	63.0	15.60	15.78
578	56.5	63.0	15.60	15.77
579	56.5	63.0	15.60	15.77
580	56.5	63.0	15.60	15.76
581	56.6	63.0	15.60	15.75
582	56.6	63.0	15.60	15.75
583	56.6	63.0	15.60	15.74
584	56.6	63.0	15.60	15.73
585	56.7	63.0	15.60	15.73
586	56.7	63.0	15.60	15.72
587	56.7	63.0	15.60	15.71
588	56.8	63.0	15.60	15.71
589	56.8	63.0	15.60	15.70
590	56.8	63.0	15.60	15.69
591	56.8	63.0	15.60	15.69
592	56.9	63.0	15.60	15.68
593	56.9	63.0	15.60	15.67
594	56.9	63.0	15.60	15.67
595	56.9	63.0	15.60	15.66
596	57.0	63.0	15.60	15.65
597	57.0	63.0	15.60	15.65
598	57.0	63.0	15.60	15.64
599	57.0	63.0	15.60	15.63
600	57.1	63.0	15.60	15.63
601	57.1	63.0	15.60	15.62
602	57.1	63.1	15.60	15.61
603	57.2	63.1	15.60	15.61
604	57.2	63.1	15.60	15.60
605	57.2	63.1	15.60	15.59
606	57.2	63.1	15.60	15.59
607	57.3	63.1	15.60	15.58
608	57.3	63.1	15.60	15.57
609	57.3	63.1	15.60	15.57
610	57.3	63.1	15.60	15.56
611	57.4	63.1	15.60	15.55
612	57.4	63.1	15.60	15.55
613	57.4	63.1	15.60	15.54
614	57.4	63.1	15.60	15.53
615	57.5	63.1	15.60	15.53
616	57.5	63.1	15.60	15.52
617	57.5	63.1	15.60	15.51
618	57.6	63.1	15.60	15.51
619	57.6	63.1	15.60	15.50
620	57.6	63.1	15.60	15.49
621	57.6	63.1	15.60	15.49
622	57.7	63.1	15.60	15.48
623	57.7	63.1	15.60	15.48
624	57.7	63.1	15.60	15.47
625	57.7	63.1	15.60	15.46
626	57.8	63.1	15.60	15.46
627	57.8	63.1	15.60	15.45
628	57.8	63.1	15.60	15.44
629	57.8	63.1	15.60	15.44

室内ユニット 合計容量	能力 (kW)		入力 (kW)	
	冷房	暖房	冷房	暖房
630	57.9	63.1	15.60	15.43
631	57.9	63.1	15.60	15.42
632	57.9	63.1	15.60	15.42
633	58.0	63.1	15.60	15.41
634	58.0	63.1	15.60	15.40
635	58.0	63.1	15.60	15.40
636	58.0	63.1	15.60	15.39
637	58.1	63.1	15.60	15.38
638	58.1	63.1	15.60	15.38
639	58.1	63.1	15.60	15.37
640	58.1	63.1	15.60	15.36
641	58.2	63.1	15.60	15.36
642	58.2	63.1	15.60	15.35
643	58.2	63.1	15.60	15.34
644	58.3	63.1	15.60	15.34
645	58.3	63.1	15.60	15.33
646	58.3	63.1	15.60	15.32
647	58.3	63.1	15.60	15.32
648	58.4	63.1	15.60	15.31
649	58.4	63.1	15.60	15.30
650	58.4	63.1	15.60	15.30
651	58.4	63.1	15.60	15.29
652	58.5	63.1	15.60	15.28
653	58.5	63.1	15.60	15.28
654	58.5	63.1	15.60	15.27
655	58.5	63.1	15.60	15.26
656	58.6	63.1	15.60	15.26
657	58.6	63.1	15.60	15.25
658	58.6	63.1	15.60	15.24
659	58.7	63.1	15.60	15.24
660	58.7	63.1	15.60	15.23
661	58.7	63.1	15.60	15.22
662	58.7	63.1	15.60	15.22
663	58.8	63.1	15.60	15.21
664	58.8	63.1	15.60	15.20
665	58.8	63.1	15.60	15.20
666	58.8	63.1	15.60	15.19
667	58.9	63.1	15.60	15.18
668	58.9	63.1	15.60	15.18
669	58.9	63.1	15.60	15.17
670	58.9	63.1	15.60	15.16
671	59.0	63.1	15.60	15.16
672	59.0	63.1	15.60	15.15
673	59.0	63.1	15.60	15.14
674	59.1	63.1	15.60	15.14
675	59.1	63.1	15.60	15.13
676	59.1	63.1	15.60	15.12
677	59.1	63.1	15.60	15.12
678	59.2	63.1	15.60	15.11
679	59.2	63.1	15.60	15.10
680	59.2	63.1	15.60	15.10
681	59.2	63.1	15.60	15.09
682	59.3	63.1	15.60	15.08
683	59.3	63.1	15.60	15.08
684	59.3	63.1	15.60	15.07
685	59.4	63.2	15.60	15.06
686	59.4	63.2	15.60	15.06
687	59.4	63.2	15.61	15.05
688	59.4	63.2	15.61	15.04
689	59.5	63.2	15.61	15.04
690	59.5	63.2	15.61	15.03
691	59.5	63.2	15.61	15.02
692	59.5	63.2	15.61	15.02
693	59.6	63.2	15.61	15.01
694	59.6	63.2	15.61	15.01
695	59.6	63.2	15.61	15.00
696	59.6	63.2	15.61	14.99
697	59.7	63.2	15.61	14.99
698	59.7	63.2	15.61	14.98
699	59.7	63.2	15.61	14.97



## 【PUHY-P560M-E】

室内ユニット 合計容量	能力 (kW)		入力 (kW)	
	冷房	暖房	冷房	暖房
700	59.8	63.2	15.61	14.97
701	59.8	63.2	15.61	14.96
702	59.8	63.2	15.61	14.95
703	59.8	63.2	15.61	14.95
704	59.9	63.2	15.61	14.94
705	59.9	63.2	15.61	14.93
706	59.9	63.2	15.61	14.93
707	59.9	63.2	15.61	14.92
708	60.0	63.2	15.61	14.91
709	60.0	63.2	15.61	14.91
710	60.0	63.2	15.61	14.90
711	60.0	63.2	15.61	14.89
712	60.1	63.2	15.61	14.89
713	60.1	63.2	15.61	14.88
714	60.1	63.2	15.61	14.87
715	60.2	63.2	15.61	14.87
716	60.2	63.2	15.61	14.86
717	60.2	63.2	15.61	14.85
718	60.2	63.2	15.61	14.85
719	60.3	63.2	15.61	14.84
720	60.3	63.2	15.61	14.83
721	60.3	63.2	15.61	14.83
722	60.3	63.2	15.61	14.82
723	60.4	63.2	15.61	14.81
724	60.4	63.2	15.61	14.81
725	60.4	63.2	15.61	14.80
726	60.4	63.2	15.61	14.79
727	60.5	63.2	15.61	14.79
728	60.5	63.2	15.61	14.78

【PUHY-P630M-E】

室内ユニット 合計容量	能力 (kW)		入力 (kW)	
	冷房	暖房	冷房	暖房
315	31.5	35.0	7.13	8.49
316	31.6	35.2	7.15	8.51
317	31.7	35.3	7.18	8.54
318	31.8	35.5	7.21	8.56
319	31.9	35.6	7.24	8.59
320	32.0	35.8	7.26	8.61
321	32.1	35.9	7.29	8.64
322	32.2	36.0	7.32	8.66
323	32.3	36.0	7.35	8.69
324	32.4	36.0	7.37	8.71
325	32.5	36.2	7.40	8.74
326	32.6	36.3	7.43	8.76
327	32.7	36.5	7.46	8.79
328	32.8	36.6	7.48	8.81
329	32.9	36.8	7.51	8.84
330	33.0	36.9	7.54	8.86
331	33.1	37.0	7.57	8.89
332	33.2	37.0	7.60	8.92
333	33.3	37.0	7.62	8.94
334	33.4	37.2	7.65	8.97
335	33.5	37.3	7.68	8.99
336	33.6	37.5	7.71	9.02
337	33.7	37.6	7.74	9.04
338	33.8	37.8	7.77	9.07
339	33.9	37.9	7.79	9.09
340	34.0	38.0	7.82	9.12
341	34.1	38.0	7.85	9.14
342	34.2	38.0	7.88	9.17
343	34.3	38.2	7.91	9.19
344	34.4	38.3	7.94	9.22
345	34.5	38.5	7.96	9.24
346	34.6	38.6	7.99	9.27
347	34.7	38.8	8.02	9.29
348	34.8	38.9	8.05	9.32
349	34.9	39.0	8.08	9.34
350	35.0	39.0	8.11	9.37
351	35.1	39.0	8.14	9.39
352	35.2	39.2	8.17	9.42
353	35.3	39.3	8.19	9.44
354	35.4	39.5	8.22	9.47
355	35.5	39.6	8.25	9.49
356	35.6	39.8	8.28	9.52
357	35.7	39.9	8.31	9.54
358	35.8	40.0	8.34	9.57
359	35.9	40.0	8.37	9.59
360	36.0	40.0	8.40	9.62
361	36.1	40.2	8.43	9.64
362	36.2	40.3	8.46	9.67
363	36.3	40.5	8.49	9.70
364	36.4	40.6	8.52	9.72
365	36.5	40.8	8.54	9.75
366	36.6	40.9	8.57	9.77
367	36.7	41.0	8.60	9.80
368	36.8	41.0	8.63	9.82
369	36.9	41.0	8.66	9.85
370	37.0	41.2	8.69	9.87
371	37.1	41.3	8.72	9.90
372	37.2	41.5	8.75	9.92
373	37.3	41.6	8.78	9.95
374	37.4	41.8	8.81	9.97
375	37.5	41.9	8.84	10.00
376	37.6	42.0	8.87	10.02
377	37.7	42.0	8.90	10.05
378	37.8	42.0	8.93	10.07
379	37.9	42.2	8.96	10.10
380	38.0	42.3	8.99	10.12
381	38.1	42.5	9.02	10.15
382	38.2	42.6	9.05	10.17
383	38.3	42.8	9.08	10.20
384	38.4	42.9	9.11	10.22

室内ユニット 合計容量	能力 (kW)		入力 (kW)	
	冷房	暖房	冷房	暖房
385	38.5	43.0	9.14	10.25
386	38.6	43.0	9.17	10.27
387	38.7	43.0	9.20	10.30
388	38.8	43.2	9.23	10.33
389	38.9	43.3	9.26	10.35
390	39.0	43.5	9.29	10.38
391	39.1	43.6	9.32	10.40
392	39.2	43.8	9.35	10.43
393	39.3	43.9	9.38	10.45
394	39.4	44.0	9.41	10.48
395	39.5	44.0	9.44	10.50
396	39.6	44.0	9.47	10.53
397	39.7	44.2	9.50	10.55
398	39.8	44.3	9.53	10.58
399	39.9	44.5	9.56	10.60
400	40.0	44.6	9.60	10.63
401	40.1	44.8	9.63	10.65
402	40.2	44.9	9.66	10.68
403	40.3	45.0	9.69	10.70
404	40.4	45.0	9.72	10.73
405	40.5	45.0	9.75	10.75
406	40.6	45.2	9.78	10.78
407	40.7	45.3	9.81	10.80
408	40.8	45.5	9.84	10.83
409	40.9	45.6	9.87	10.86
410	41.0	45.8	9.90	10.88
411	41.1	45.9	9.93	10.91
412	41.2	46.0	9.96	10.93
413	41.3	46.0	10.00	10.96
414	41.4	46.0	10.03	10.98
415	41.5	46.2	10.06	11.01
416	41.6	46.3	10.09	11.03
417	41.7	46.5	10.12	11.06
418	41.8	46.6	10.15	11.08
419	41.9	46.8	10.18	11.11
420	42.0	46.9	10.21	11.13
421	42.1	47.0	10.24	11.16
422	42.2	47.0	10.28	11.18
423	42.3	47.0	10.31	11.21
424	42.4	47.2	10.34	11.23
425	42.5	47.3	10.37	11.26
426	42.6	47.5	10.40	11.28
427	42.7	47.6	10.43	11.31
428	42.8	47.8	10.46	11.34
429	42.9	47.9	10.49	11.36
430	43.0	48.0	10.53	11.39
431	43.1	48.0	10.56	11.41
432	43.2	48.0	10.59	11.44
433	43.3	48.2	10.62	11.46
434	43.4	48.3	10.65	11.49
435	43.5	48.5	10.68	11.51
436	43.6	48.6	10.71	11.54
437	43.7	48.8	10.75	11.56
438	43.8	48.9	10.78	11.59
439	43.9	49.0	10.81	11.61
440	44.0	49.0	10.84	11.64
441	44.1	49.0	10.87	11.66
442	44.2	49.2	10.90	11.69
443	44.3	49.3	10.94	11.71
444	44.4	49.5	10.97	11.74
445	44.5	49.6	11.00	11.76
446	44.6	49.8	11.03	11.79
447	44.7	49.9	11.06	11.82
448	44.8	50.0	11.10	11.84
449	44.9	50.0	11.13	11.87
450	45.0	50.0	11.16	11.89
451	45.1	50.2	11.19	11.92
452	45.2	50.3	11.22	11.94
453	45.3	50.5	11.26	11.97
454	45.4	50.6	11.29	11.99

室内ユニット 合計容量	能力 (kW)		入力 (kW)	
	冷房	暖房	冷房	暖房
455	45.5	50.8	11.32	12.02
456	45.6	50.9	11.35	12.04
457	45.7	51.0	11.38	12.07
458	45.8	51.0	11.42	12.09
459	45.9	51.0	11.45	12.12
460	46.0	51.2	11.48	12.14
461	46.1	51.3	11.51	12.17
462	46.2	51.5	11.54	12.20
463	46.3	51.6	11.58	12.22
464	46.4	51.8	11.61	12.25
465	46.5	51.9	11.64	12.27
466	46.6	52.0	11.67	12.30
467	46.7	52.0	11.71	12.32
468	46.8	52.0	11.74	12.35
469	46.9	52.2	11.77	12.37
470	47.0	52.3	11.80	12.40
471	47.1	52.5	11.83	12.42
472	47.2	52.6	11.87	12.45
473	47.3	52.8	11.90	12.47
474	47.4	52.9	11.93	12.50
475	47.5	53.0	11.96	12.52
476	47.6	53.0	12.00	12.55
477	47.7	53.0	12.03	12.57
478	47.8	53.2	12.06	12.60
479	47.9	53.3	12.09	12.63
480	48.0	53.5	12.13	12.65
481	48.1	53.6	12.16	12.68
482	48.2	53.8	12.19	12.70
483	48.3	53.9	12.22	12.73
484	48.4	54.0	12.26	12.75
485	48.5	54.0	12.29	12.78
486	48.6	54.0	12.32	12.80
487	48.7	54.2	12.35	12.83
488	48.8	54.3	12.39	12.85
489	48.9	54.5	12.42	12.88
490	49.0	54.6	12.45	12.90
491	49.1	54.8	12.48	12.93
492	49.2	54.9	12.52	12.96
493	49.3	55.0	12.55	12.98
494	49.4	55.0	12.58	13.01
495	49.5	55.0	12.62	13.03
496	49.6	55.2	12.65	13.06
497	49.7	55.3	12.68	13.08
498	49.8	55.5	12.71	13.11
499	49.9	55.6	12.75	13.13
500	50.0	55.8	12.78	13.16
501	50.1	55.9	12.81	13.18
502	50.2	56.0	12.84	13.21
503	50.3	56.0	12.88	13.23
504	50.4	56.0	12.91	13.26
505	50.5	56.2	12.94	13.28
506	50.6	56.3	12.98	13.31
507	50.7	56.5	13.01	13.34
508	50.8	56.6	13.04	13.36
509	50.9	56.8	13.07	13.39
510	51.0	56.9	13.11	13.41
511	51.1	57.0	13.14	13.44
512	51.2	57.0	13.17	13.46
513	51.3	57.0	13.21	13.49
514	51.4	57.2	13.24	13.51
515	51.5	57.3	13.27	13.54
516	51.6	57.5	13.30	13.56
517	51.7	57.6	13.34	13.59
518	51.8	57.8	13.37	13.61
519	51.9	57.9	13.40	13.64
520	52.0	58.0	13.44	13.67
521	52.1	58.0	13.47	13.69
522	52.2	58.0	13.50	13.72
523	52.3	58.2	13.54	13.74
524	52.4	58.3	13.57	13.77

【PUHY-P630M-E】

室内ユニット 合計容量	能力 (kW)		入力 (kW)	
	冷房	暖房	冷房	暖房
525	52.5	58.5	13.60	13.79
526	52.6	58.6	13.63	13.82
527	52.7	58.8	13.67	13.84
528	52.8	58.9	13.70	13.87
529	52.9	59.0	13.73	13.89
530	53.0	59.0	13.77	13.92
531	53.1	59.0	13.80	13.95
532	53.2	59.2	13.83	13.97
533	53.3	59.3	13.87	14.00
534	53.4	59.5	13.90	14.02
535	53.5	59.6	13.93	14.05
536	53.6	59.8	13.97	14.07
537	53.7	59.9	14.00	14.10
538	53.8	60.0	14.03	14.12
539	53.9	60.0	14.07	14.15
540	54.0	60.0	14.10	14.17
541	54.1	60.2	14.13	14.20
542	54.2	60.3	14.16	14.22
543	54.3	60.5	14.20	14.25
544	54.4	60.6	14.23	14.28
545	54.5	60.8	14.26	14.30
546	54.6	60.9	14.30	14.33
547	54.7	61.0	14.33	14.35
548	54.8	61.0	14.36	14.38
549	54.9	61.0	14.40	14.40
550	55.0	61.2	14.43	14.43
551	55.1	61.3	14.46	14.45
552	55.2	61.5	14.50	14.48
553	55.3	61.6	14.53	14.50
554	55.4	61.8	14.56	14.53
555	55.5	61.9	14.60	14.56
556	55.6	62.0	14.63	14.58
557	55.7	62.0	14.66	14.61
558	55.8	62.0	14.70	14.63
559	55.9	62.2	14.73	14.66
560	56.0	62.3	14.76	14.68
561	56.1	62.5	14.80	14.71
562	56.2	62.5	14.83	14.73
563	56.3	62.7	14.86	14.76
564	56.4	62.8	14.89	14.78
565	56.5	63.0	14.93	14.81
566	56.6	63.0	14.96	14.84
567	56.7	63.0	14.99	14.86
568	56.8	63.2	15.03	14.89
569	56.9	63.3	15.06	14.91
570	57.0	63.5	15.09	14.94
571	57.1	63.5	15.13	14.96
572	57.2	63.7	15.16	14.99
573	57.3	63.8	15.19	15.01
574	57.4	64.0	15.23	15.04
575	57.5	64.0	15.26	15.06
576	57.6	64.0	15.29	15.09
577	57.7	64.2	15.33	15.12
578	57.8	64.3	15.36	15.14
579	57.9	64.5	15.39	15.17
580	58.0	64.5	15.43	15.19
581	58.1	64.7	15.46	15.22
582	58.2	64.8	15.49	15.24
583	58.3	65.0	15.53	15.27
584	58.4	65.0	15.56	15.29
585	58.5	65.0	15.59	15.32
586	58.6	65.2	15.63	15.34
587	58.7	65.3	15.66	15.37
588	58.8	65.5	15.69	15.40
589	58.9	65.5	15.73	15.42
590	59.0	65.7	15.76	15.45
591	59.1	65.8	15.79	15.47
592	59.2	66.0	15.83	15.50
593	59.3	66.0	15.86	15.52
594	59.4	66.0	15.89	15.55

室内ユニット 合計容量	能力 (kW)		入力 (kW)	
	冷房	暖房	冷房	暖房
595	59.5	66.2	15.92	15.57
596	59.6	66.3	15.96	15.60
597	59.7	66.5	15.99	15.62
598	59.8	66.5	16.02	15.65
599	59.9	66.7	16.06	15.68
600	60.0	66.8	16.09	15.70
601	60.1	67.0	16.12	15.73
602	60.2	67.0	16.16	15.75
603	60.3	67.0	16.19	15.78
604	60.4	67.0	16.22	15.80
605	60.5	67.0	16.26	15.83
606	60.6	67.0	16.29	15.85
607	60.7	67.0	16.32	15.88
608	60.8	67.0	16.36	15.91
609	60.9	67.0	16.39	15.93
610	61.0	67.0	16.42	15.96
611	61.1	67.0	16.45	15.98
612	61.2	67.0	16.49	16.01
613	61.3	67.0	16.52	16.03
614	61.4	67.0	16.55	16.06
615	61.5	67.0	16.59	16.08
616	61.6	67.0	16.62	16.11
617	61.7	67.0	16.65	16.14
618	61.8	67.0	16.69	16.16
619	61.9	67.0	16.72	16.19
620	62.0	67.0	16.75	16.21
621	62.1	67.0	16.78	16.24
622	62.2	67.0	16.82	16.26
623	62.3	67.0	16.85	16.29
624	62.4	67.0	16.88	16.31
625	62.5	67.0	16.92	16.34
626	62.6	67.0	16.95	16.36
627	62.7	67.0	16.98	16.39
628	62.8	67.0	17.02	16.42
629	62.9	67.0	17.05	16.44
630	63.0	67.0	17.08	16.37
631	63.0	67.0	17.08	16.36
632	63.1	67.0	17.08	16.36
633	63.1	67.0	17.08	16.35
634	63.1	67.0	17.08	16.34
635	63.2	67.0	17.08	16.34
636	63.2	67.0	17.08	16.33
637	63.2	67.0	17.08	16.33
638	63.2	67.0	17.08	16.32
639	63.3	67.0	17.08	16.32
640	63.3	67.0	17.09	16.31
641	63.3	67.0	17.09	16.30
642	63.4	67.0	17.09	16.30
643	63.4	67.0	17.09	16.29
644	63.4	67.0	17.09	16.29
645	63.5	67.0	17.09	16.28
646	63.5	67.0	17.09	16.28
647	63.5	67.0	17.09	16.27
648	63.6	67.0	17.09	16.27
649	63.6	67.0	17.09	16.26
650	63.6	67.0	17.09	16.25
651	63.7	67.0	17.09	16.25
652	63.7	67.0	17.09	16.24
653	63.7	67.0	17.09	16.24
654	63.7	67.0	17.09	16.23
655	63.8	67.0	17.09	16.23
656	63.8	67.0	17.09	16.22
657	63.8	67.0	17.09	16.22
658	63.9	67.0	17.09	16.21
659	63.9	67.0	17.09	16.20
660	63.9	67.0	17.09	16.20
661	64.0	67.0	17.09	16.19
662	64.0	67.0	17.10	16.19
663	64.0	67.0	17.10	16.18
664	64.1	67.0	17.10	16.18

室内ユニット 合計容量	能力 (kW)		入力 (kW)	
	冷房	暖房	冷房	暖房
665	64.1	67.0	17.10	16.17
666	64.1	67.0	17.10	16.17
667	64.2	67.0	17.10	16.16
668	64.2	67.0	17.10	16.15
669	64.2	67.0	17.10	16.15
670	64.2	67.0	17.10	16.14
671	64.3	67.0	17.10	16.14
672	64.3	67.1	17.10	16.13
673	64.3	67.1	17.10	16.13
674	64.4	67.1	17.10	16.12
675	64.4	67.1	17.10	16.11
676	64.4	67.1	17.10	16.11
677	64.5	67.1	17.10	16.10
678	64.5	67.1	17.10	16.10
679	64.5	67.1	17.10	16.09
680	64.6	67.1	17.10	16.09
681	64.6	67.1	17.10	16.08
682	64.6	67.1	17.10	16.08
683	64.7	67.1	17.11	16.07
684	64.7	67.1	17.11	16.06
685	64.7	67.1	17.11	16.06
686	64.7	67.1	17.11	16.05
687	64.8	67.1	17.11	16.05
688	64.8	67.1	17.11	16.04
689	64.8	67.1	17.11	16.04
690	64.9	67.1	17.11	16.03
691	64.9	67.1	17.11	16.03
692	64.9	67.1	17.11	16.02
693	65.0	67.1	17.11	16.01
694	65.0	67.1	17.11	16.01
695	65.0	67.1	17.11	16.00
696	65.1	67.1	17.11	16.00
697	65.1	67.1	17.11	15.99
698	65.1	67.1	17.11	15.99
699	65.2	67.1	17.11	15.98
700	65.2	67.1	17.11	15.97
701	65.2	67.1	17.11	15.97
702	65.2	67.1	17.11	15.96
703	65.3	67.1	17.11	15.96
704	65.3	67.1	17.11	15.95
705	65.3	67.1	17.12	15.95
706	65.4	67.1	17.12	15.94
707	65.4	67.1	17.12	15.94
708	65.4	67.1	17.12	15.93
709	65.5	67.1	17.12	15.92
710	65.5	67.1	17.12	15.92
711	65.5	67.1	17.12	15.91
712	65.6	67.1	17.12	15.91
713	65.6	67.1	17.12	15.90
714	65.6	67.1	17.12	15.90
715	65.7	67.1	17.12	15.89
716	65.7	67.1	17.12	15.89
717	65.7	67.1	17.12	15.88
718	65.7	67.1	17.12	15.87
719	65.8	67.1	17.12	15.87
720	65.8	67.1	17.12	15.86
721	65.8	67.1	17.12	15.86
722	65.9	67.1	17.12	15.85
723	65.9	67.1	17.12	15.85
724	65.9	67.1	17.12	15.84
725	66.0	67.1	17.12	15.84
726	66.0	67.1	17.12	15.83
727	66.0	67.1	17.13	15.82
728	66.1	67.1	17.13	15.82
729	66.1	67.1	17.13	15.81
730	66.1	67.1	17.13	15.81
731	66.2	67.1	17.13	15.80
732	66.2	67.1	17.13	15.80
733	66.2	67.1	17.13	15.79
734	66.2	67.1	17.13	15.78

【PUHY-P630M-E】

室内ユニット 合計容量	能力 (kW)		入力 (kW)	
	冷房	暖房	冷房	暖房
735	66.3	67.1	17.13	15.78
736	66.3	67.1	17.13	15.77
737	66.3	67.1	17.13	15.77
738	66.4	67.1	17.13	15.76
739	66.4	67.1	17.13	15.76
740	66.4	67.1	17.13	15.75
741	66.5	67.1	17.13	15.75
742	66.5	67.1	17.13	15.74
743	66.5	67.1	17.13	15.73
744	66.6	67.1	17.13	15.73
745	66.6	67.1	17.13	15.72
746	66.6	67.1	17.13	15.72
747	66.7	67.1	17.13	15.71
748	66.7	67.1	17.14	15.71
749	66.7	67.1	17.14	15.70
750	66.7	67.1	17.14	15.70
751	66.8	67.1	17.14	15.69
752	66.8	67.1	17.14	15.68
753	66.8	67.1	17.14	15.68
754	66.9	67.1	17.14	15.67
755	66.9	67.2	17.14	15.67
756	66.9	67.2	17.14	15.66
757	67.0	67.2	17.14	15.66
758	67.0	67.2	17.14	15.65
759	67.0	67.2	17.14	15.64
760	67.1	67.2	17.14	15.64
761	67.1	67.2	17.14	15.63
762	67.1	67.2	17.14	15.63
763	67.1	67.2	17.14	15.62
764	67.2	67.2	17.14	15.62
765	67.2	67.2	17.14	15.61
766	67.2	67.2	17.14	15.61
767	67.3	67.2	17.14	15.60
768	67.3	67.2	17.14	15.59
769	67.3	67.2	17.14	15.59
770	67.4	67.2	17.15	15.58
771	67.4	67.2	17.15	15.58
772	67.4	67.2	17.15	15.57
773	67.5	67.2	17.15	15.57
774	67.5	67.2	17.15	15.56
775	67.5	67.2	17.15	15.56
776	67.6	67.2	17.15	15.55
777	67.6	67.2	17.15	15.54
778	67.6	67.2	17.15	15.54
779	67.6	67.2	17.15	15.53
780	67.7	67.2	17.15	15.53
781	67.7	67.2	17.15	15.52
782	67.7	67.2	17.15	15.52
783	67.8	67.2	17.15	15.51
784	67.8	67.2	17.15	15.51
785	67.8	67.2	17.15	15.50
786	67.9	67.2	17.15	15.49
787	67.9	67.2	17.15	15.49
788	67.9	67.2	17.15	15.48
789	68.0	67.2	17.15	15.48
790	68.0	67.2	17.15	15.47
791	68.0	67.2	17.15	15.47
792	68.1	67.2	17.16	15.46
793	68.1	67.2	17.16	15.45
794	68.1	67.2	17.16	15.45
795	68.1	67.2	17.16	15.44
796	68.2	67.2	17.16	15.44
797	68.2	67.2	17.16	15.43
798	68.2	67.2	17.16	15.43
799	68.3	67.2	17.16	15.42
800	68.3	67.2	17.16	15.42
801	68.3	67.2	17.16	15.41
802	68.4	67.2	17.16	15.40
803	68.4	67.2	17.16	15.40
804	68.4	67.2	17.16	15.39

室内ユニット 合計容量	能力 (kW)		入力 (kW)	
	冷房	暖房	冷房	暖房
805	68.5	67.2	17.16	15.39
806	68.5	67.2	17.16	15.38
807	68.5	67.2	17.16	15.38
808	68.6	67.2	17.16	15.37
809	68.6	67.2	17.16	15.37
810	68.6	67.2	17.16	15.36
811	68.6	67.2	17.16	15.35
812	68.7	67.2	17.16	15.35
813	68.7	67.2	17.17	15.34
814	68.7	67.2	17.17	15.34
815	68.8	67.2	17.17	15.33
816	68.8	67.2	17.17	15.33
817	68.8	67.2	17.17	15.32
818	68.9	67.2	17.17	15.31
819	68.9	67.2	17.17	15.31

【PUHY-P674M-E】

室内ユニット 合計容量	能力 (kW)		入力 (kW)	
	冷房	暖房	冷房	暖房
337	33.7	37.5	7.75	9.22
338	33.8	37.7	7.78	9.24
339	33.9	37.8	7.81	9.27
340	34.0	38.0	7.84	9.29
341	34.1	38.0	7.87	9.32
342	34.2	38.0	7.89	9.34
343	34.3	38.2	7.92	9.37
344	34.4	38.3	7.95	9.40
345	34.5	38.5	7.98	9.42
346	34.6	38.5	8.01	9.45
347	34.7	38.7	8.04	9.47
348	34.8	38.8	8.07	9.50
349	34.9	39.0	8.10	9.52
350	35.0	39.0	8.12	9.55
351	35.1	39.0	8.15	9.58
352	35.2	39.2	8.18	9.60
353	35.3	39.3	8.21	9.63
354	35.4	39.5	8.24	9.65
355	35.5	39.5	8.27	9.68
356	35.6	39.7	8.30	9.70
357	35.7	39.8	8.33	9.73
358	35.8	40.0	8.36	9.75
359	35.9	40.0	8.39	9.78
360	36.0	40.0	8.42	9.81
361	36.1	40.2	8.45	9.83
362	36.2	40.3	8.48	9.86
363	36.3	40.5	8.50	9.88
364	36.4	40.5	8.53	9.91
365	36.5	40.7	8.56	9.93
366	36.6	40.8	8.59	9.96
367	36.7	41.0	8.62	9.98
368	36.8	41.0	8.65	10.01
369	36.9	41.0	8.68	10.04
370	37.0	41.2	8.71	10.06
371	37.1	41.3	8.74	10.09
372	37.2	41.5	8.77	10.11
373	37.3	41.5	8.80	10.14
374	37.4	41.7	8.83	10.16
375	37.5	41.8	8.86	10.19
376	37.6	42.0	8.89	10.22
377	37.7	42.0	8.92	10.24
378	37.8	42.0	8.95	10.27
379	37.9	42.2	8.98	10.29
380	38.0	42.3	9.01	10.32
381	38.1	42.5	9.04	10.34
382	38.2	42.5	9.07	10.37
383	38.3	42.7	9.10	10.39
384	38.4	42.8	9.13	10.42
385	38.5	43.0	9.16	10.45
386	38.6	43.0	9.19	10.47
387	38.7	43.0	9.22	10.50
388	38.8	43.2	9.25	10.52
389	38.9	43.3	9.28	10.55
390	39.0	43.5	9.31	10.57
391	39.1	43.5	9.34	10.60
392	39.2	43.7	9.37	10.62
393	39.3	43.8	9.40	10.65
394	39.4	44.0	9.43	10.68
395	39.5	44.0	9.46	10.70
396	39.6	44.0	9.49	10.73
397	39.7	44.2	9.52	10.75
398	39.8	44.3	9.55	10.78
399	39.9	44.5	9.58	10.80
400	40.0	44.5	9.61	10.83
401	40.1	44.7	9.64	10.86
402	40.2	44.8	9.67	10.88
403	40.3	45.0	9.70	10.91
404	40.4	45.0	9.73	10.93
405	40.5	45.0	9.76	10.96
406	40.6	45.2	9.79	10.98

室内ユニット 合計容量	能力 (kW)		入力 (kW)	
	冷房	暖房	冷房	暖房
407	40.7	45.3	9.82	11.01
408	40.8	45.5	9.86	11.03
409	40.9	45.5	9.89	11.06
410	41.0	45.7	9.92	11.09
411	41.1	45.8	9.95	11.11
412	41.2	46.0	9.98	11.14
413	41.3	46.0	10.01	11.16
414	41.4	46.0	10.04	11.19
415	41.5	46.2	10.07	11.21
416	41.6	46.3	10.10	11.24
417	41.7	46.5	10.13	11.26
418	41.8	46.5	10.16	11.29
419	41.9	46.7	10.19	11.32
420	42.0	46.8	10.22	11.34
421	42.1	47.0	10.25	11.37
422	42.2	47.0	10.28	11.39
423	42.3	47.0	10.31	11.42
424	42.4	47.2	10.34	11.44
425	42.5	47.3	10.38	11.47
426	42.6	47.5	10.41	11.49
427	42.7	47.5	10.44	11.52
428	42.8	47.7	10.47	11.55
429	42.9	47.8	10.50	11.57
430	43.0	48.0	10.53	11.60
431	43.1	48.0	10.56	11.62
432	43.2	48.0	10.59	11.65
433	43.3	48.2	10.62	11.67
434	43.4	48.3	10.65	11.70
435	43.5	48.5	10.68	11.72
436	43.6	48.5	10.71	11.75
437	43.7	48.7	10.74	11.78
438	43.8	48.8	10.77	11.80
439	43.9	49.0	10.81	11.83
440	44.0	49.0	10.84	11.85
441	44.1	49.0	10.87	11.88
442	44.2	49.2	10.90	11.90
443	44.3	49.3	10.93	11.93
444	44.4	49.5	10.96	11.95
445	44.5	49.5	10.99	11.98
446	44.6	49.7	11.02	12.01
447	44.7	49.8	11.05	12.03
448	44.8	50.0	11.08	12.06
449	44.9	50.0	11.11	12.08
450	45.0	50.0	11.15	12.11
451	45.1	50.2	11.18	12.13
452	45.2	50.3	11.21	12.16
453	45.3	50.5	11.24	12.18
454	45.4	50.5	11.27	12.21
455	45.5	50.7	11.30	12.24
456	45.6	50.8	11.33	12.26
457	45.7	51.0	11.36	12.29
458	45.8	51.0	11.39	12.31
459	45.9	51.0	11.42	12.34
460	46.0	51.2	11.45	12.36
461	46.1	51.3	11.49	12.39
462	46.2	51.5	11.52	12.41
463	46.3	51.5	11.55	12.44
464	46.4	51.7	11.58	12.47
465	46.5	51.8	11.61	12.49
466	46.6	52.0	11.64	12.52
467	46.7	52.0	11.67	12.54
468	46.8	52.0	11.70	12.57
469	46.9	52.2	11.73	12.59
470	47.0	52.3	11.76	12.62
471	47.1	52.5	11.79	12.64
472	47.2	52.5	11.82	12.67
473	47.3	52.7	11.86	12.70
474	47.4	52.8	11.89	12.72
475	47.5	53.0	11.92	12.75
476	47.6	53.0	11.95	12.77

室内ユニット 合計容量	能力 (kW)		入力 (kW)	
	冷房	暖房	冷房	暖房
477	47.7	53.0	11.98	12.80
478	47.8	53.2	12.01	12.82
479	47.9	53.3	12.04	12.85
480	48.0	53.5	12.07	12.87
481	48.1	53.5	12.10	12.90
482	48.2	53.7	12.13	12.93
483	48.3	53.8	12.16	12.95
484	48.4	54.0	12.20	12.98
485	48.5	54.0	12.23	13.00
486	48.6	54.0	12.26	13.03
487	48.7	54.2	12.29	13.05
488	48.8	54.3	12.32	13.08
489	48.9	54.5	12.35	13.10
490	49.0	54.5	12.38	13.13
491	49.1	54.7	12.41	13.16
492	49.2	54.8	12.44	13.18
493	49.3	55.0	12.47	13.21
494	49.4	55.0	12.50	13.23
495	49.5	55.0	12.53	13.26
496	49.6	55.2	12.56	13.28
497	49.7	55.3	12.60	13.31
498	49.8	55.5	12.63	13.33
499	49.9	55.5	12.66	13.36
500	50.0	55.7	12.69	13.39
501	50.1	55.8	12.72	13.41
502	50.2	56.0	12.75	13.44
503	50.3	56.0	12.78	13.46
504	50.4	56.0	12.81	13.49
505	50.5	56.2	12.84	13.51
506	50.6	56.3	12.87	13.54
507	50.7	56.5	12.90	13.56
508	50.8	56.5	12.93	13.59
509	50.9	56.7	12.96	13.62
510	51.0	56.8	12.99	13.64
511	51.1	57.0	13.02	13.67
512	51.2	57.0	13.05	13.69
513	51.3	57.0	13.09	13.72
514	51.4	57.2	13.12	13.74
515	51.5	57.3	13.15	13.77
516	51.6	57.5	13.18	13.79
517	51.7	57.5	13.21	13.82
518	51.8	57.7	13.24	13.85
519	51.9	57.8	13.27	13.87
520	52.0	58.0	13.30	13.90
521	52.1	58.0	13.33	13.92
522	52.2	58.0	13.36	13.95
523	52.3	58.2	13.39	13.97
524	52.4	58.3	13.42	14.00
525	52.5	58.5	13.45	14.02
526	52.6	58.5	13.48	14.05
527	52.7	58.7	13.51	14.08
528	52.8	58.8	13.54	14.10
529	52.9	59.0	13.57	14.13
530	53.0	59.0	13.60	14.15
531	53.1	59.0	13.63	14.18
532	53.2	59.2	13.66	14.20
533	53.3	59.3	13.69	14.23
534	53.4	59.5	13.72	14.25
535	53.5	59.5	13.75	14.28
536	53.6	59.7	13.78	14.30
537	53.7	59.8	13.81	14.33
538	53.8	60.0	13.84	14.36
539	53.9	60.0	13.87	14.38
540	54.0	60.0	13.90	14.41
541	54.1	60.2	13.93	14.43
542	54.2	60.3	13.96	14.46
543	54.3	60.5	13.99	14.48
544	54.4	60.5	14.02	14.51
545	54.5	60.7	14.05	14.53
546	54.6	60.8	14.08	14.56

【PUHY-P674M-E】

室内ユニット 合計容量	能力 (kW)		入力 (kW)	
	冷房	暖房	冷房	暖房
547	54.7	61.0	14.11	14.59
548	54.8	61.0	14.14	14.61
549	54.9	61.0	14.17	14.64
550	55.0	61.2	14.20	14.66
551	55.1	61.3	14.23	14.69
552	55.2	61.5	14.26	14.71
553	55.3	61.5	14.29	14.74
554	55.4	61.7	14.32	14.76
555	55.5	61.8	14.35	14.79
556	55.6	62.0	14.38	14.81
557	55.7	62.0	14.41	14.84
558	55.8	62.0	14.44	14.87
559	55.9	62.2	14.47	14.89
560	56.0	62.3	14.50	14.92
561	56.1	62.5	14.53	14.94
562	56.2	62.5	14.56	14.97
563	56.3	62.7	14.59	14.99
564	56.4	62.8	14.61	15.02
565	56.5	63.0	14.64	15.04
566	56.6	63.0	14.67	15.07
567	56.7	63.0	14.70	15.10
568	56.8	63.2	14.73	15.12
569	56.9	63.3	14.76	15.15
570	57.0	63.5	14.79	15.17
571	57.1	63.5	14.82	15.20
572	57.2	63.7	14.85	15.22
573	57.3	63.8	14.88	15.25
574	57.4	64.0	14.91	15.27
575	57.5	64.0	14.94	15.30
576	57.6	64.0	14.96	15.33
577	57.7	64.2	14.99	15.35
578	57.8	64.3	15.02	15.38
579	57.9	64.5	15.05	15.40
580	58.0	64.5	15.08	15.43
581	58.1	64.7	15.11	15.45
582	58.2	64.8	15.14	15.48
583	58.3	65.0	15.17	15.50
584	58.4	65.0	15.20	15.53
585	58.5	65.0	15.22	15.55
586	58.6	65.2	15.25	15.58
587	58.7	65.3	15.28	15.61
588	58.8	65.5	15.31	15.63
589	58.9	65.5	15.34	15.66
590	59.0	65.7	15.37	15.68
591	59.1	65.8	15.39	15.71
592	59.2	66.0	15.42	15.73
593	59.3	66.0	15.45	15.76
594	59.4	66.0	15.48	15.78
595	59.5	66.2	15.51	15.81
596	59.6	66.3	15.54	15.83
597	59.7	66.5	15.56	15.86
598	59.8	66.5	15.59	15.89
599	59.9	66.7	15.62	15.91
600	60.0	66.8	15.65	15.94
601	60.1	67.0	15.68	15.96
602	60.2	67.0	15.70	15.99
603	60.3	67.0	15.73	16.01
604	60.4	67.2	15.76	16.04
605	60.5	67.3	15.79	16.06
606	60.6	67.5	15.82	16.09
607	60.7	67.5	15.84	16.12
608	60.8	67.7	15.87	16.14
609	60.9	67.8	15.90	16.17
610	61.0	68.0	15.93	16.19
611	61.1	68.0	15.95	16.22
612	61.2	68.0	15.98	16.24
613	61.3	68.2	16.01	16.27
614	61.4	68.3	16.04	16.29
615	61.5	68.5	16.06	16.32
616	61.6	68.5	16.09	16.34

室内ユニット 合計容量	能力 (kW)		入力 (kW)	
	冷房	暖房	冷房	暖房
617	61.7	68.7	16.12	16.37
618	61.8	68.8	16.15	16.40
619	61.9	69.0	16.17	16.42
620	62.0	69.0	16.20	16.45
621	62.1	69.0	16.23	16.47
622	62.2	69.2	16.26	16.50
623	62.3	69.3	16.28	16.52
624	62.4	69.5	16.31	16.55
625	62.5	69.5	16.34	16.57
626	62.6	69.7	16.36	16.60
627	62.7	69.8	16.39	16.62
628	62.8	70.0	16.42	16.65
629	62.9	70.0	16.44	16.68
630	63.0	70.0	16.47	16.70
631	63.1	70.2	16.50	16.73
632	63.2	70.3	16.52	16.75
633	63.3	70.5	16.55	16.78
634	63.4	70.5	16.58	16.80
635	63.5	70.7	16.60	16.83
636	63.6	70.8	16.63	16.85
637	63.7	71.0	16.66	16.88
638	63.8	71.0	16.68	16.90
639	63.9	71.0	16.71	16.93
640	64.0	71.2	16.73	16.96
641	64.1	71.3	16.76	16.98
642	64.2	71.5	16.79	17.01
643	64.3	71.5	16.81	17.03
644	64.4	71.7	16.84	17.06
645	64.5	71.8	16.86	17.08
646	64.6	72.0	16.89	17.11
647	64.7	72.0	16.92	17.13
648	64.8	72.0	16.94	17.16
649	64.9	72.2	16.97	17.19
650	65.0	72.3	16.99	17.21
651	65.1	72.5	17.02	17.24
652	65.2	72.5	17.04	17.26
653	65.3	72.7	17.07	17.29
654	65.4	72.8	17.09	17.31
655	65.5	73.0	17.12	17.34
656	65.6	73.0	17.15	17.36
657	65.7	73.0	17.17	17.39
658	65.8	73.2	17.20	17.41
659	65.9	73.3	17.22	17.44
660	66.0	73.5	17.25	17.47
661	66.1	73.5	17.27	17.49
662	66.2	73.7	17.30	17.52
663	66.3	73.8	17.32	17.54
664	66.4	74.0	17.35	17.57
665	66.5	74.0	17.37	17.59
666	66.6	74.0	17.39	17.62
667	66.7	74.2	17.42	17.64
668	66.8	74.3	17.44	17.67
669	66.9	74.5	17.47	17.69
670	67.0	74.5	17.49	17.72
671	67.1	74.7	17.52	17.75
672	67.2	74.8	17.54	17.77
673	67.3	75.0	17.57	17.80
674	67.4	75.0	17.59	17.83
675	67.4	75.0	17.60	17.85
676	67.5	75.0	17.60	17.87
677	67.5	75.0	17.60	17.89
678	67.5	75.0	17.60	17.91
679	67.5	75.0	17.60	17.93
680	67.6	75.0	17.60	17.95
681	67.6	75.0	17.60	17.97
682	67.6	75.0	17.60	17.99
683	67.6	75.0	17.60	18.01
684	67.7	75.0	17.60	18.03
685	67.7	75.0	17.60	18.05
686	67.7	75.0	17.60	18.07

室内ユニット 合計容量	能力 (kW)		入力 (kW)	
	冷房	暖房	冷房	暖房
687	67.8	75.0	17.60	17.65
688	67.8	75.0	17.60	17.65
689	67.8	75.0	17.60	17.64
690	67.8	75.0	17.60	17.64
691	67.9	75.0	17.60	17.63
692	67.9	75.0	17.60	17.62
693	67.9	75.0	17.60	17.62
694	67.9	75.0	17.60	17.61
695	68.0	75.0	17.60	17.61
696	68.0	75.0	17.60	17.60
697	68.0	75.0	17.61	17.59
698	68.1	75.0	17.61	17.59
699	68.1	75.0	17.61	17.58
700	68.1	75.0	17.61	17.58
701	68.1	75.0	17.61	17.57
702	68.2	75.0	17.61	17.56
703	68.2	75.0	17.61	17.56
704	68.2	75.1	17.61	17.55
705	68.2	75.1	17.61	17.55
706	68.3	75.1	17.61	17.54
707	68.3	75.1	17.61	17.54
708	68.3	75.1	17.61	17.53
709	68.3	75.1	17.61	17.52
710	68.4	75.1	17.61	17.52
711	68.4	75.1	17.61	17.51
712	68.4	75.1	17.61	17.51
713	68.5	75.1	17.61	17.50
714	68.5	75.1	17.61	17.49
715	68.5	75.1	17.61	17.49
716	68.5	75.1	17.61	17.48
717	68.6	75.1	17.61	17.48
718	68.6	75.1	17.61	17.47
719	68.6	75.1	17.61	17.46
720	68.6	75.1	17.62	17.46
721	68.7	75.1	17.62	17.45
722	68.7	75.1	17.62	17.45
723	68.7	75.1	17.62	17.44
724	68.8	75.1	17.62	17.43
725	68.8	75.1	17.62	17.43
726	68.8	75.1	17.62	17.42
727	68.8	75.1	17.62	17.42
728	68.9	75.1	17.62	17.41
729	68.9	75.1	17.62	17.41
730	68.9	75.1	17.62	17.40
731	68.9	75.1	17.62	17.39
732	69.0	75.1	17.62	17.39
733	69.0	75.1	17.62	17.38
734	69.0	75.1	17.62	17.38
735	69.1	75.1	17.62	17.37
736	69.1	75.1	17.62	17.36
737	69.1	75.1	17.62	17.36
738	69.1	75.1	17.62	17.35
739	69.2	75.1	17.62	17.35
740	69.2	75.1	17.62	17.34
741	69.2	75.1	17.62	17.33
742	69.2	75.1	17.62	17.33
743	69.3	75.1	17.63	17.32
744	69.3	75.1	17.63	17.32
745	69.3	75.1	17.63	17.31
746	69.4	75.1	17.63	17.30
747	69.4	75.1	17.63	17.30
748	69.4	75.1	17.63	17.29
749	69.4	75.1	17.63	17.29
750	69.5	75.1	17.63	17.28
751	69.5	75.1	17.63	17.28
752	69.5	75.1	17.63	17.27
753	69.5	75.1	17.63	17.26
754	69.6	75.1	17.63	17.26
755	69.6	75.1	17.63	17.25
756	69.6	75.1	17.63	17.25

## 【PUHY-P674M-E】

室内工口 合計容量	能力 (kW)		入力 (kW)	
	冷房	暖房	冷房	暖房
757	69.6	75.1	17.63	17.24
758	69.7	75.1	17.63	17.23
759	69.7	75.1	17.63	17.23
760	69.7	75.1	17.63	17.22
761	69.8	75.1	17.63	17.22
762	69.8	75.1	17.63	17.21
763	69.8	75.2	17.63	17.20
764	69.8	75.2	17.63	17.20
765	69.9	75.2	17.63	17.19
766	69.9	75.2	17.64	17.19
767	69.9	75.2	17.64	17.18
768	69.9	75.2	17.64	17.17
769	70.0	75.2	17.64	17.17
770	70.0	75.2	17.64	17.16
771	70.0	75.2	17.64	17.16
772	70.1	75.2	17.64	17.15
773	70.1	75.2	17.64	17.15
774	70.1	75.2	17.64	17.14
775	70.1	75.2	17.64	17.13
776	70.2	75.2	17.64	17.13
777	70.2	75.2	17.64	17.12
778	70.2	75.2	17.64	17.12
779	70.2	75.2	17.64	17.11
780	70.3	75.2	17.64	17.10
781	70.3	75.2	17.64	17.10
782	70.3	75.2	17.64	17.09
783	70.4	75.2	17.64	17.09
784	70.4	75.2	17.64	17.08
785	70.4	75.2	17.64	17.07
786	70.4	75.2	17.64	17.07
787	70.5	75.2	17.64	17.06
788	70.5	75.2	17.64	17.06
789	70.5	75.2	17.65	17.05
790	70.5	75.2	17.65	17.05
791	70.6	75.2	17.65	17.04
792	70.6	75.2	17.65	17.03
793	70.6	75.2	17.65	17.03
794	70.7	75.2	17.65	17.02
795	70.7	75.2	17.65	17.02
796	70.7	75.2	17.65	17.01
797	70.7	75.2	17.65	17.00
798	70.8	75.2	17.65	17.00
799	70.8	75.2	17.65	16.99
800	70.8	75.2	17.65	16.99
801	70.8	75.2	17.65	16.98
802	70.9	75.2	17.65	16.97
803	70.9	75.2	17.65	16.97
804	70.9	75.2	17.65	16.96
805	71.0	75.2	17.65	16.96
806	71.0	75.2	17.65	16.95
807	71.0	75.2	17.65	16.94
808	71.0	75.2	17.65	16.94
809	71.1	75.2	17.65	16.93
810	71.1	75.2	17.65	16.93
811	71.1	75.2	17.65	16.92
812	71.1	75.2	17.66	16.92
813	71.2	75.2	17.66	16.91
814	71.2	75.2	17.66	16.90
815	71.2	75.2	17.66	16.90
816	71.2	75.2	17.66	16.89
817	71.3	75.2	17.66	16.89
818	71.3	75.2	17.66	16.88
819	71.3	75.2	17.66	16.87
820	71.4	75.2	17.66	16.87
821	71.4	75.2	17.66	16.86
822	71.4	75.3	17.66	16.86
823	71.4	75.3	17.66	16.85
824	71.5	75.3	17.66	16.84
825	71.5	75.3	17.66	16.84
826	71.5	75.3	17.66	16.83

室内工口 合計容量	能力 (kW)		入力 (kW)	
	冷房	暖房	冷房	暖房
827	71.5	75.3	17.66	16.83
828	71.6	75.3	17.66	16.82
829	71.6	75.3	17.66	16.81
830	71.6	75.3	17.66	16.81
831	71.7	75.3	17.66	16.80
832	71.7	75.3	17.66	16.80
833	71.7	75.3	17.66	16.79
834	71.7	75.3	17.67	16.79
835	71.8	75.3	17.67	16.78
836	71.8	75.3	17.67	16.77
837	71.8	75.3	17.67	16.77
838	71.8	75.3	17.67	16.76
839	71.9	75.3	17.67	16.76
840	71.9	75.3	17.67	16.75
841	71.9	75.3	17.67	16.74
842	72.0	75.3	17.67	16.74
843	72.0	75.3	17.67	16.73
844	72.0	75.3	17.67	16.73
845	72.0	75.3	17.67	16.72
846	72.1	75.3	17.67	16.71
847	72.1	75.3	17.67	16.71
848	72.1	75.3	17.67	16.70
849	72.1	75.3	17.67	16.70
850	72.2	75.3	17.67	16.69
851	72.2	75.3	17.67	16.68
852	72.2	75.3	17.67	16.68
853	72.3	75.3	17.67	16.67
854	72.3	75.3	17.67	16.67
855	72.3	75.3	17.67	16.66
856	72.3	75.3	17.67	16.66
857	72.4	75.3	17.68	16.65
858	72.4	75.3	17.68	16.64
859	72.4	75.3	17.68	16.64
860	72.4	75.3	17.68	16.63
861	72.5	75.3	17.68	16.63
862	72.5	75.3	17.68	16.62
863	72.5	75.3	17.68	16.61
864	72.5	75.3	17.68	16.61
865	72.6	75.3	17.68	16.60
866	72.6	75.3	17.68	16.60
867	72.6	75.3	17.68	16.59
868	72.7	75.3	17.68	16.58
869	72.7	75.3	17.68	16.58
870	72.7	75.3	17.68	16.57
871	72.7	75.3	17.68	16.57
872	72.8	75.3	17.68	16.56
873	72.8	75.3	17.68	16.55
874	72.8	75.3	17.68	16.55
875	72.8	75.3	17.68	16.54
876	72.9	75.3	17.68	16.54

【PUHY-P730M-E】

室内ユニット 合計容量	能力 (kW)		入力 (kW)	
	冷房	暖房	冷房	暖房
365	36.5	40.7	9.05	9.55
366	36.6	40.8	9.08	9.58
367	36.7	41.0	9.11	9.61
368	36.8	41.0	9.14	9.63
369	36.9	41.0	9.17	9.66
370	37.0	41.2	9.20	9.68
371	37.1	41.3	9.23	9.71
372	37.2	41.5	9.26	9.74
373	37.3	41.5	9.28	9.76
374	37.4	41.7	9.31	9.79
375	37.5	41.8	9.34	9.81
376	37.6	42.0	9.37	9.84
377	37.7	42.0	9.40	9.87
378	37.8	42.0	9.43	9.89
379	37.9	42.2	9.46	9.92
380	38.0	42.3	9.49	9.94
381	38.1	42.5	9.52	9.97
382	38.2	42.5	9.54	10.00
383	38.3	42.7	9.57	10.02
384	38.4	42.8	9.60	10.05
385	38.5	43.0	9.63	10.08
386	38.6	43.0	9.66	10.10
387	38.7	43.0	9.69	10.13
388	38.8	43.2	9.72	10.15
389	38.9	43.3	9.75	10.18
390	39.0	43.5	9.78	10.21
391	39.1	43.5	9.80	10.23
392	39.2	43.7	9.83	10.26
393	39.3	43.8	9.86	10.29
394	39.4	44.0	9.89	10.31
395	39.5	44.0	9.92	10.34
396	39.6	44.0	9.95	10.36
397	39.7	44.2	9.98	10.39
398	39.8	44.3	10.01	10.42
399	39.9	44.5	10.03	10.44
400	40.0	44.5	10.06	10.47
401	40.1	44.7	10.09	10.50
402	40.2	44.8	10.12	10.52
403	40.3	45.0	10.15	10.55
404	40.4	45.0	10.18	10.58
405	40.5	45.0	10.21	10.60
406	40.6	45.2	10.24	10.63
407	40.7	45.3	10.27	10.66
408	40.8	45.5	10.30	10.68
409	40.9	45.5	10.32	10.71
410	41.0	45.7	10.35	10.74
411	41.1	45.8	10.38	10.76
412	41.2	46.0	10.41	10.79
413	41.3	46.0	10.44	10.82
414	41.4	46.0	10.47	10.84
415	41.5	46.2	10.50	10.87
416	41.6	46.3	10.53	10.89
417	41.7	46.5	10.56	10.92
418	41.8	46.5	10.58	10.95
419	41.9	46.7	10.61	10.97
420	42.0	46.8	10.64	11.00
421	42.1	47.0	10.67	11.03
422	42.2	47.0	10.70	11.06
423	42.3	47.0	10.73	11.08
424	42.4	47.2	10.76	11.11
425	42.5	47.3	10.79	11.14
426	42.6	47.5	10.82	11.16
427	42.7	47.5	10.85	11.19
428	42.8	47.7	10.87	11.22
429	42.9	47.8	10.90	11.24
430	43.0	48.0	10.93	11.27
431	43.1	48.0	10.96	11.30
432	43.2	48.0	10.99	11.32
433	43.3	48.2	11.02	11.35
434	43.4	48.3	11.05	11.38

室内ユニット 合計容量	能力 (kW)		入力 (kW)	
	冷房	暖房	冷房	暖房
435	43.5	48.5	11.08	11.40
436	43.6	48.5	11.11	11.43
437	43.7	48.7	11.14	11.46
438	43.8	48.8	11.16	11.48
439	43.9	49.0	11.19	11.51
440	44.0	49.0	11.22	11.54
441	44.1	49.0	11.25	11.56
442	44.2	49.2	11.28	11.59
443	44.3	49.3	11.31	11.62
444	44.4	49.5	11.34	11.65
445	44.5	49.5	11.37	11.67
446	44.6	49.7	11.40	11.70
447	44.7	49.8	11.43	11.73
448	44.8	50.0	11.45	11.75
449	44.9	50.0	11.48	11.78
450	45.0	50.0	11.51	11.81
451	45.1	50.2	11.54	11.84
452	45.2	50.3	11.57	11.86
453	45.3	50.5	11.60	11.89
454	45.4	50.5	11.63	11.92
455	45.5	50.7	11.66	11.94
456	45.6	50.8	11.69	11.97
457	45.7	51.0	11.72	12.00
458	45.8	51.0	11.75	12.03
459	45.9	51.0	11.77	12.05
460	46.0	51.2	11.80	12.08
461	46.1	51.3	11.83	12.11
462	46.2	51.5	11.86	12.13
463	46.3	51.5	11.89	12.16
464	46.4	51.7	11.92	12.19
465	46.5	51.8	11.95	12.22
466	46.6	52.0	11.98	12.24
467	46.7	52.0	12.01	12.27
468	46.8	52.0	12.04	12.30
469	46.9	52.2	12.07	12.32
470	47.0	52.3	12.09	12.35
471	47.1	52.5	12.12	12.38
472	47.2	52.5	12.15	12.41
473	47.3	52.7	12.18	12.43
474	47.4	52.8	12.21	12.46
475	47.5	53.0	12.24	12.49
476	47.6	53.0	12.27	12.52
477	47.7	53.0	12.30	12.54
478	47.8	53.2	12.33	12.57
479	47.9	53.3	12.36	12.60
480	48.0	53.5	12.39	12.63
481	48.1	53.5	12.42	12.65
482	48.2	53.7	12.44	12.68
483	48.3	53.8	12.47	12.71
484	48.4	54.0	12.50	12.74
485	48.5	54.0	12.53	12.76
486	48.6	54.0	12.56	12.79
487	48.7	54.2	12.59	12.82
488	48.8	54.3	12.62	12.85
489	48.9	54.5	12.65	12.87
490	49.0	54.5	12.68	12.90
491	49.1	54.7	12.71	12.93
492	49.2	54.8	12.74	12.96
493	49.3	55.0	12.77	12.98
494	49.4	55.0	12.80	13.01
495	49.5	55.0	12.82	13.04
496	49.6	55.2	12.85	13.07
497	49.7	55.3	12.88	13.10
498	49.8	55.5	12.91	13.12
499	49.9	55.5	12.94	13.15
500	50.0	55.7	12.97	13.18
501	50.1	55.8	13.00	13.21
502	50.2	56.0	13.03	13.23
503	50.3	56.0	13.06	13.26
504	50.4	56.0	13.09	13.29

室内ユニット 合計容量	能力 (kW)		入力 (kW)	
	冷房	暖房	冷房	暖房
505	50.5	56.2	13.12	13.32
506	50.6	56.3	13.15	13.34
507	50.7	56.5	13.18	13.37
508	50.8	56.5	13.20	13.40
509	50.9	56.7	13.23	13.43
510	51.0	56.8	13.26	13.46
511	51.1	57.0	13.29	13.48
512	51.2	57.0	13.32	13.51
513	51.3	57.0	13.35	13.54
514	51.4	57.2	13.38	13.57
515	51.5	57.3	13.41	13.60
516	51.6	57.5	13.44	13.62
517	51.7	57.5	13.47	13.65
518	51.8	57.7	13.50	13.68
519	51.9	57.8	13.53	13.71
520	52.0	58.0	13.56	13.74
521	52.1	58.0	13.59	13.76
522	52.2	58.0	13.61	13.79
523	52.3	58.2	13.64	13.82
524	52.4	58.3	13.67	13.85
525	52.5	58.5	13.70	13.88
526	52.6	58.5	13.73	13.90
527	52.7	58.7	13.76	13.93
528	52.8	58.8	13.79	13.96
529	52.9	59.0	13.82	13.99
530	53.0	59.0	13.85	14.02
531	53.1	59.0	13.88	14.04
532	53.2	59.2	13.91	14.07
533	53.3	59.3	13.94	14.10
534	53.4	59.5	13.97	14.13
535	53.5	59.5	14.00	14.16
536	53.6	59.7	14.03	14.18
537	53.7	59.8	14.05	14.21
538	53.8	60.0	14.08	14.24
539	53.9	60.0	14.11	14.27
540	54.0	60.0	14.14	14.30
541	54.1	60.2	14.17	14.33
542	54.2	60.3	14.20	14.35
543	54.3	60.5	14.23	14.38
544	54.4	60.5	14.26	14.41
545	54.5	60.7	14.29	14.44
546	54.6	60.8	14.32	14.47
547	54.7	61.0	14.35	14.50
548	54.8	61.0	14.38	14.52
549	54.9	61.0	14.41	14.55
550	55.0	61.2	14.44	14.58
551	55.1	61.3	14.47	14.61
552	55.2	61.5	14.50	14.64
553	55.3	61.5	14.52	14.67
554	55.4	61.7	14.55	14.69
555	55.5	61.8	14.58	14.72
556	55.6	62.0	14.61	14.75
557	55.7	62.0	14.64	14.78
558	55.8	62.0	14.67	14.81
559	55.9	62.2	14.70	14.84
560	56.0	62.3	14.73	14.87
561	56.1	62.5	14.76	14.89
562	56.2	62.5	14.79	14.92
563	56.3	62.7	14.82	14.95
564	56.4	62.8	14.85	14.98
565	56.5	63.0	14.88	15.01
566	56.6	63.0	14.91	15.04
567	56.7	63.0	14.94	15.07
568	56.8	63.2	14.97	15.09
569	56.9	63.3	15.00	15.12
570	57.0	63.5	15.03	15.15
571	57.1	63.5	15.06	15.18
572	57.2	63.7	15.08	15.21
573	57.3	63.8	15.11	15.24
574	57.4	64.0	15.14	15.27



## 【PUHY-P730M-E】

室内ユニット 合計容量	能力 (kW)		入力 (kW)	
	冷房	暖房	冷房	暖房
575	57.5	64.0	15.17	15.29
576	57.6	64.0	15.20	15.32
577	57.7	64.2	15.23	15.35
578	57.8	64.3	15.26	15.38
579	57.9	64.5	15.29	15.41
580	58.0	64.5	15.32	15.44
581	58.1	64.7	15.35	15.47
582	58.2	64.8	15.38	15.50
583	58.3	65.0	15.41	15.52
584	58.4	65.0	15.44	15.55
585	58.5	65.0	15.47	15.58
586	58.6	65.2	15.50	15.61
587	58.7	65.3	15.53	15.64
588	58.8	65.5	15.56	15.67
589	58.9	65.5	15.59	15.70
590	59.0	65.7	15.62	15.73
591	59.1	65.8	15.65	15.76
592	59.2	66.0	15.67	15.78
593	59.3	66.0	15.70	15.81
594	59.4	66.0	15.73	15.84
595	59.5	66.2	15.76	15.87
596	59.6	66.3	15.79	15.90
597	59.7	66.5	15.82	15.93
598	59.8	66.5	15.85	15.96
599	59.9	66.7	15.88	15.99
600	60.0	66.8	15.91	16.02
601	60.1	67.0	15.94	16.05
602	60.2	67.0	15.97	16.07
603	60.3	67.0	16.00	16.10
604	60.4	67.2	16.03	16.13
605	60.5	67.3	16.06	16.16
606	60.6	67.5	16.09	16.19
607	60.7	67.5	16.12	16.22
608	60.8	67.7	16.15	16.25
609	60.9	67.8	16.18	16.28
610	61.0	68.0	16.21	16.31
611	61.1	68.0	16.24	16.34
612	61.2	68.0	16.27	16.37
613	61.3	68.2	16.30	16.39
614	61.4	68.3	16.33	16.42
615	61.5	68.5	16.36	16.45
616	61.6	68.5	16.39	16.48
617	61.7	68.7	16.41	16.51
618	61.8	68.8	16.44	16.54
619	61.9	69.0	16.47	16.57
620	62.0	69.0	16.50	16.60
621	62.1	69.0	16.53	16.63
622	62.2	69.2	16.56	16.66
623	62.3	69.3	16.59	16.69
624	62.4	69.5	16.62	16.72
625	62.5	69.5	16.65	16.75
626	62.6	69.7	16.68	16.78
627	62.7	69.8	16.71	16.80
628	62.8	70.0	16.74	16.83
629	62.9	70.0	16.77	16.86
630	63.0	70.0	16.80	16.89
631	63.1	70.2	16.83	16.92
632	63.2	70.3	16.86	16.95
633	63.3	70.5	16.89	16.98
634	63.4	70.5	16.92	17.01
635	63.5	70.7	16.95	17.04
636	63.6	70.8	16.98	17.07
637	63.7	71.0	17.01	17.10
638	63.8	71.0	17.04	17.13
639	63.9	71.0	17.07	17.16
640	64.0	71.2	17.10	17.19
641	64.1	71.3	17.13	17.22
642	64.2	71.5	17.16	17.25
643	64.3	71.5	17.19	17.28
644	64.4	71.7	17.22	17.31

室内ユニット 合計容量	能力 (kW)		入力 (kW)	
	冷房	暖房	冷房	暖房
645	64.5	71.8	17.25	17.34
646	64.6	72.0	17.28	17.37
647	64.7	72.0	17.31	17.39
648	64.8	72.0	17.34	17.42
649	64.9	72.2	17.37	17.45
650	65.0	72.3	17.39	17.48
651	65.1	72.5	17.42	17.51
652	65.2	72.5	17.45	17.54
653	65.3	72.7	17.48	17.57
654	65.4	72.8	17.51	17.60
655	65.5	73.0	17.54	17.63
656	65.6	73.0	17.57	17.66
657	65.7	73.0	17.60	17.69
658	65.8	73.2	17.63	17.72
659	65.9	73.3	17.66	17.75
660	66.0	73.5	17.69	17.78
661	66.1	73.5	17.72	17.81
662	66.2	73.7	17.75	17.84
663	66.3	73.8	17.78	17.87
664	66.4	74.0	17.81	17.90
665	66.5	74.0	17.84	17.93
666	66.6	74.0	17.87	17.96
667	66.7	74.2	17.90	17.99
668	66.8	74.3	17.93	18.02
669	66.9	74.5	17.96	18.05
670	67.0	74.5	17.99	18.08
671	67.1	74.7	18.02	18.11
672	67.2	74.8	18.05	18.14
673	67.3	75.0	18.08	18.17
674	67.4	75.0	18.11	18.20
675	67.5	75.0	18.14	18.23
676	67.6	75.2	18.17	18.26
677	67.7	75.3	18.20	18.29
678	67.8	75.5	18.23	18.32
679	67.9	75.5	18.26	18.35
680	68.0	75.7	18.29	18.38
681	68.1	75.8	18.32	18.41
682	68.2	76.0	18.35	18.44
683	68.3	76.0	18.38	18.47
684	68.4	76.0	18.41	18.50
685	68.5	76.2	18.44	18.53
686	68.6	76.3	18.47	18.56
687	68.7	76.5	18.50	18.59
688	68.8	76.5	18.53	18.62
689	68.9	76.7	18.56	18.65
690	69.0	76.8	18.59	18.68
691	69.1	77.0	18.62	18.71
692	69.2	77.0	18.65	18.74
693	69.3	77.0	18.68	18.77
694	69.4	77.2	18.71	18.80
695	69.5	77.3	18.74	18.83
696	69.6	77.5	18.77	18.86
697	69.7	77.5	18.80	18.89
698	69.8	77.7	18.83	18.92
699	69.9	77.8	18.86	18.95
700	70.0	78.0	18.89	18.98
701	70.1	78.0	18.92	19.01
702	70.2	78.0	18.95	19.04
703	70.3	78.2	18.98	19.07
704	70.4	78.3	19.01	19.10
705	70.5	78.5	19.04	19.13
706	70.6	78.5	19.07	19.16
707	70.7	78.7	19.10	19.19
708	70.8	78.8	19.13	19.22
709	70.9	79.0	19.16	19.25
710	71.0	79.0	19.19	19.28
711	71.1	79.0	19.22	19.31
712	71.2	79.2	19.25	19.34
713	71.3	79.3	19.28	19.37
714	71.4	79.5	19.31	19.40

室内ユニット 合計容量	能力 (kW)		入力 (kW)	
	冷房	暖房	冷房	暖房
715	71.5	79.5	19.34	19.44
716	71.6	79.7	19.37	19.47
717	71.7	79.8	19.40	19.50
718	71.8	80.0	19.43	19.53
719	71.9	80.0	19.46	19.56
720	72.0	80.0	19.49	19.59
721	72.1	80.2	19.52	19.62
722	72.2	80.3	19.55	19.65
723	72.3	80.5	19.58	19.69
724	72.4	80.5	19.61	19.72
725	72.5	80.7	19.64	19.75
726	72.6	80.8	19.67	19.78
727	72.7	81.0	19.70	19.81
728	72.8	81.0	19.73	19.84
729	72.9	81.0	19.76	19.87
730	73.0	81.5	19.65	19.82
731	73.0	81.5	19.65	19.81
732	73.1	81.5	19.65	19.80
733	73.1	81.5	19.65	19.80
734	73.1	81.5	19.65	19.79
735	73.1	81.5	19.65	19.79
736	73.2	81.5	19.65	19.78
737	73.2	81.5	19.65	19.78
738	73.2	81.5	19.65	19.77
739	73.2	81.5	19.65	19.76
740	73.3	81.5	19.65	19.76
741	73.3	81.5	19.65	19.75
742	73.3	81.5	19.65	19.75
743	73.4	81.5	19.65	19.74
744	73.4	81.5	19.65	19.74
745	73.4	81.5	19.65	19.73
746	73.4	81.5	19.65	19.72
747	73.5	81.5	19.65	19.72
748	73.5	81.5	19.65	19.71
749	73.5	81.5	19.65	19.71
750	73.5	81.5	19.65	19.70
751	73.6	81.5	19.65	19.70
752	73.6	81.5	19.65	19.69
753	73.6	81.5	19.65	19.69
754	73.7	81.5	19.65	19.68
755	73.7	81.5	19.65	19.67
756	73.7	81.5	19.65	19.67
757	73.7	81.5	19.65	19.66
758	73.8	81.5	19.65	19.66
759	73.8	81.5	19.65	19.65
760	73.8	81.6	19.65	19.65
761	73.8	81.6	19.65	19.64
762	73.9	81.6	19.65	19.63
763	73.9	81.6	19.65	19.63
764	73.9	81.6	19.65	19.62
765	73.9	81.6	19.65	19.62
766	74.0	81.6	19.65	19.61
767	74.0	81.6	19.65	19.61
768	74.0	81.6	19.65	19.60
769	74.1	81.6	19.65	19.59
770	74.1	81.6	19.65	19.59
771	74.1	81.6	19.65	19.58
772	74.1	81.6	19.65	19.58
773	74.2	81.6	19.65	19.57
774	74.2	81.6	19.65	19.57
775	74.2	81.6	19.65	19.56
776	74.2	81.6	19.65	19.55
777	74.3	81.6	19.65	19.55
778	74.3	81.6	19.65	19.54
779	74.3	81.6	19.65	19.54
780	74.4	81.6	19.65	19.53
781	74.4	81.6	19.65	19.53
782	74.4	81.6	19.65	19.52
783	74.4	81.6	19.65	19.51
784	74.5	81.6	19.65	19.51

【PUHY-P730M-E】

室内ユニット 合計容量	能力 (kW)		入力 (kW)	
	冷房	暖房	冷房	暖房
785	74.5	81.6	19.65	19.50
786	74.5	81.6	19.65	19.50
787	74.5	81.6	19.65	19.49
788	74.6	81.6	19.65	19.49
789	74.6	81.6	19.65	19.48
790	74.6	81.6	19.65	19.48
791	74.7	81.6	19.65	19.47
792	74.7	81.6	19.65	19.46
793	74.7	81.6	19.65	19.46
794	74.7	81.6	19.65	19.45
795	74.8	81.6	19.65	19.45
796	74.8	81.6	19.65	19.44
797	74.8	81.6	19.65	19.44
798	74.8	81.6	19.65	19.43
799	74.9	81.6	19.65	19.42
800	74.9	81.6	19.65	19.42
801	74.9	81.6	19.65	19.41
802	75.0	81.6	19.65	19.41
803	75.0	81.6	19.65	19.40
804	75.0	81.6	19.65	19.40
805	75.0	81.6	19.65	19.39
806	75.1	81.6	19.65	19.38
807	75.1	81.6	19.65	19.38
808	75.1	81.6	19.65	19.37
809	75.1	81.6	19.65	19.37
810	75.2	81.6	19.65	19.36
811	75.2	81.6	19.65	19.36
812	75.2	81.6	19.65	19.35
813	75.2	81.6	19.65	19.34
814	75.3	81.6	19.65	19.34
815	75.3	81.6	19.65	19.33
816	75.3	81.6	19.65	19.33
817	75.4	81.6	19.65	19.32
818	75.4	81.6	19.65	19.32
819	75.4	81.7	19.65	19.31
820	75.4	81.7	19.65	19.30
821	75.5	81.7	19.65	19.30
822	75.5	81.7	19.65	19.29
823	75.5	81.7	19.65	19.29
824	75.5	81.7	19.65	19.28
825	75.6	81.7	19.65	19.28
826	75.6	81.7	19.65	19.27
827	75.6	81.7	19.65	19.27
828	75.7	81.7	19.65	19.26
829	75.7	81.7	19.65	19.25
830	75.7	81.7	19.65	19.25
831	75.7	81.7	19.65	19.24
832	75.8	81.7	19.65	19.24
833	75.8	81.7	19.65	19.23
834	75.8	81.7	19.65	19.23
835	75.8	81.7	19.65	19.22
836	75.9	81.7	19.65	19.21
837	75.9	81.7	19.65	19.21
838	75.9	81.7	19.65	19.20
839	76.0	81.7	19.65	19.20
840	76.0	81.7	19.65	19.19
841	76.0	81.7	19.65	19.19
842	76.0	81.7	19.65	19.18
843	76.1	81.7	19.65	19.17
844	76.1	81.7	19.65	19.17
845	76.1	81.7	19.65	19.16
846	76.1	81.7	19.65	19.16
847	76.2	81.7	19.65	19.15
848	76.2	81.7	19.65	19.15
849	76.2	81.7	19.65	19.14
850	76.3	81.7	19.65	19.13
851	76.3	81.7	19.65	19.13
852	76.3	81.7	19.65	19.12
853	76.3	81.7	19.65	19.12
854	76.4	81.7	19.65	19.11

室内ユニット 合計容量	能力 (kW)		入力 (kW)	
	冷房	暖房	冷房	暖房
855	76.4	81.7	19.65	19.11
856	76.4	81.7	19.65	19.10
857	76.4	81.7	19.65	19.09
858	76.5	81.7	19.65	19.09
859	76.5	81.7	19.65	19.08
860	76.5	81.7	19.65	19.08
861	76.6	81.7	19.65	19.07
862	76.6	81.7	19.65	19.07
863	76.6	81.7	19.65	19.06
864	76.6	81.7	19.65	19.06
865	76.7	81.7	19.65	19.05
866	76.7	81.7	19.65	19.04
867	76.7	81.7	19.65	19.04
868	76.7	81.7	19.65	19.03
869	76.8	81.7	19.65	19.03
870	76.8	81.7	19.65	19.02
871	76.8	81.7	19.65	19.02
872	76.8	81.7	19.65	19.01
873	76.9	81.7	19.65	19.00
874	76.9	81.7	19.65	19.00
875	76.9	81.7	19.65	18.99
876	77.0	81.7	19.65	18.99
877	77.0	81.7	19.65	18.98
878	77.0	81.8	19.65	18.98
879	77.0	81.8	19.65	18.97
880	77.1	81.8	19.65	18.96
881	77.1	81.8	19.65	18.96
882	77.1	81.8	19.65	18.95
883	77.1	81.8	19.65	18.95
884	77.2	81.8	19.65	18.94
885	77.2	81.8	19.65	18.94
886	77.2	81.8	19.65	18.93
887	77.3	81.8	19.65	18.92
888	77.3	81.8	19.65	18.92
889	77.3	81.8	19.65	18.91
890	77.3	81.8	19.65	18.91
891	77.4	81.8	19.65	18.90
892	77.4	81.8	19.65	18.90
893	77.4	81.8	19.65	18.89
894	77.4	81.8	19.65	18.88
895	77.5	81.8	19.65	18.88
896	77.5	81.8	19.65	18.87
897	77.5	81.8	19.65	18.87
898	77.6	81.8	19.65	18.86
899	77.6	81.8	19.65	18.86
900	77.6	81.8	19.65	18.85
901	77.6	81.8	19.65	18.85
902	77.7	81.8	19.65	18.84
903	77.7	81.8	19.65	18.83
904	77.7	81.8	19.65	18.83
905	77.7	81.8	19.65	18.82
906	77.8	81.8	19.65	18.82
907	77.8	81.8	19.65	18.81
908	77.8	81.8	19.65	18.81
909	77.9	81.8	19.65	18.80
910	77.9	81.8	19.65	18.79
911	77.9	81.8	19.65	18.79
912	77.9	81.8	19.65	18.78
913	78.0	81.8	19.65	18.78
914	78.0	81.8	19.65	18.77
915	78.0	81.8	19.65	18.77
916	78.0	81.8	19.65	18.76
917	78.1	81.8	19.65	18.75
918	78.1	81.8	19.65	18.75
919	78.1	81.8	19.65	18.74
920	78.1	81.8	19.65	18.74
921	78.2	81.8	19.65	18.73
922	78.2	81.8	19.65	18.73
923	78.2	81.8	19.65	18.72
924	78.3	81.8	19.65	18.71

室内ユニット 合計容量	能力 (kW)		入力 (kW)	
	冷房	暖房	冷房	暖房
925	78.3	81.8	19.65	18.71
926	78.3	81.8	19.65	18.70
927	78.3	81.8	19.65	18.70
928	78.4	81.8	19.65	18.69
929	78.4	81.8	19.65	18.69
930	78.4	81.8	19.65	18.68
931	78.4	81.8	19.65	18.67
932	78.5	81.8	19.65	18.67
933	78.5	81.8	19.65	18.66
934	78.5	81.8	19.65	18.66
935	78.6	81.8	19.65	18.65
936	78.6	81.9	19.65	18.65
937	78.6	81.9	19.65	18.64
938	78.6	81.9	19.65	18.63
939	78.7	81.9	19.65	18.63
940	78.7	81.9	19.65	18.62
941	78.7	81.9	19.65	18.62
942	78.7	81.9	19.65	18.61
943	78.8	81.9	19.65	18.61
944	78.8	81.9	19.65	18.60
945	78.8	81.9	19.65	18.60
946	78.9	81.9	19.65	18.59
947	78.9	81.9	19.65	18.58
948	78.9	81.9	19.65	18.58
949	78.9	81.9	19.65	18.57

b. 空気条件変化による補正

【PUHY-P500・P560・P630・P674・P730M-E】

・冷房能力・入力補正

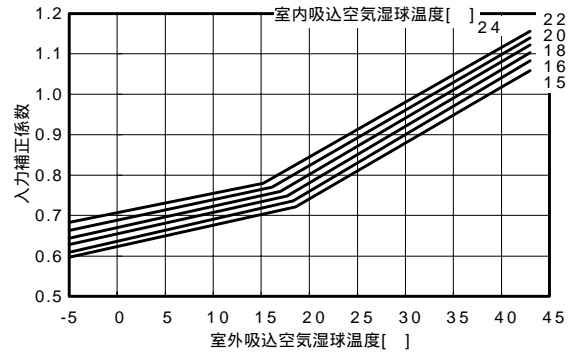
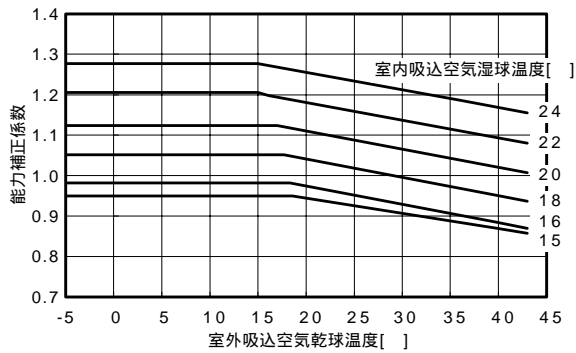

・暖房能力・入力補正

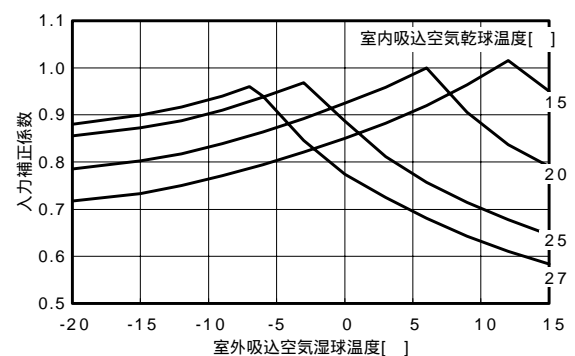
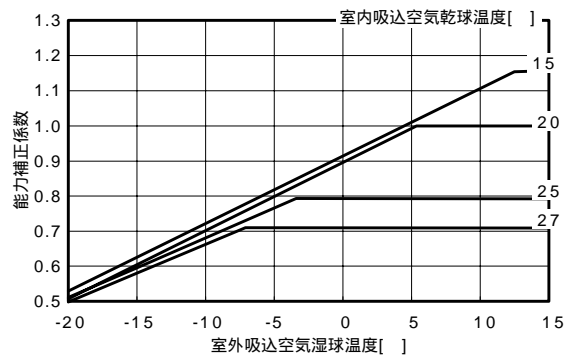

・冷房能力・入力補正 (オールフレッシュ)

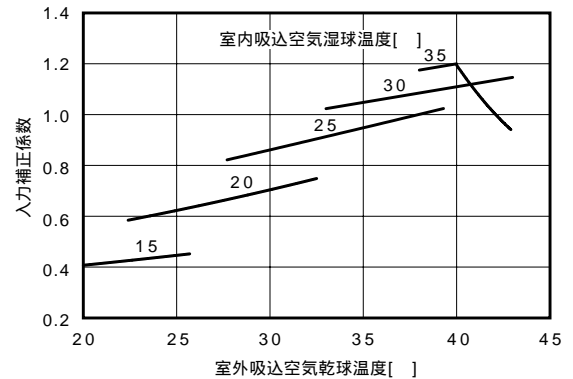
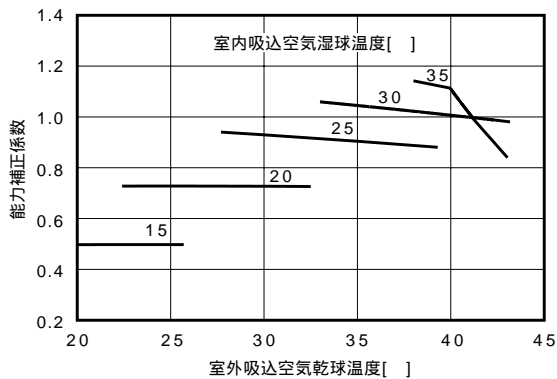

・暖房能力・入力補正 (オールフレッシュ)

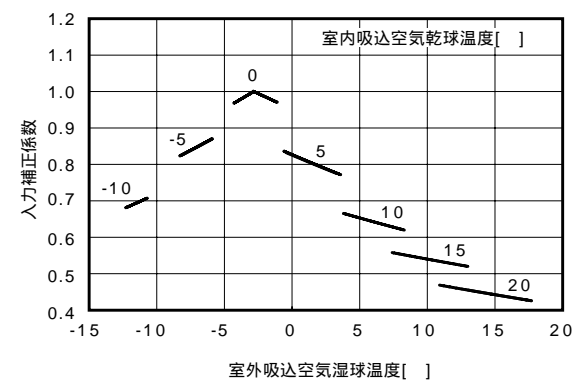
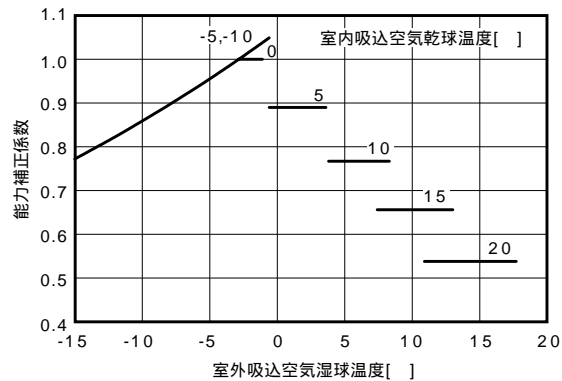

c. 冷媒配管長補正

【冷房能力補正係数】

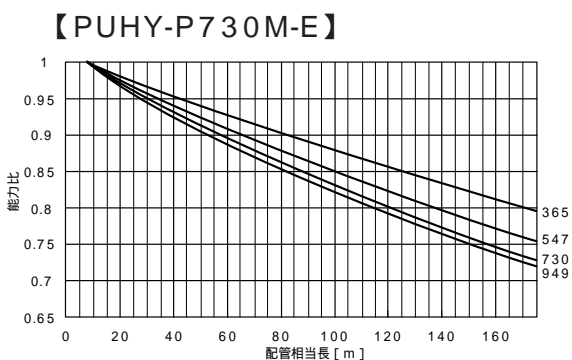
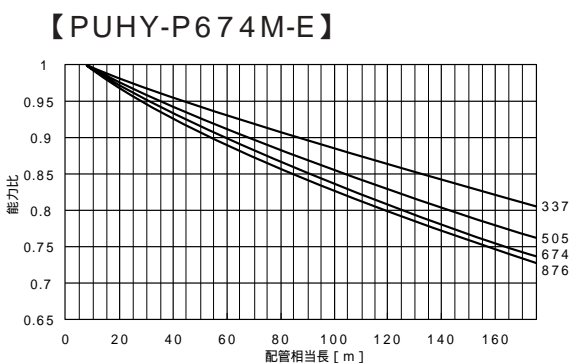
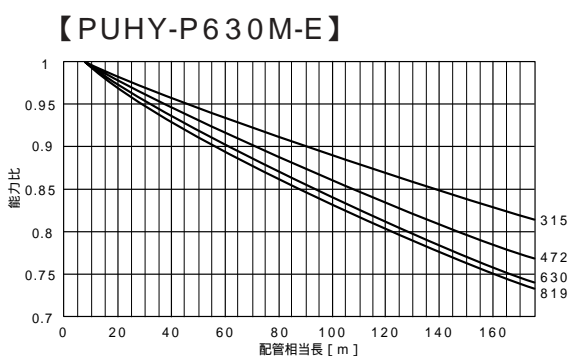
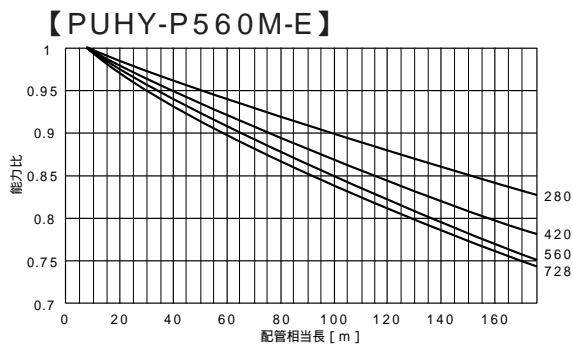
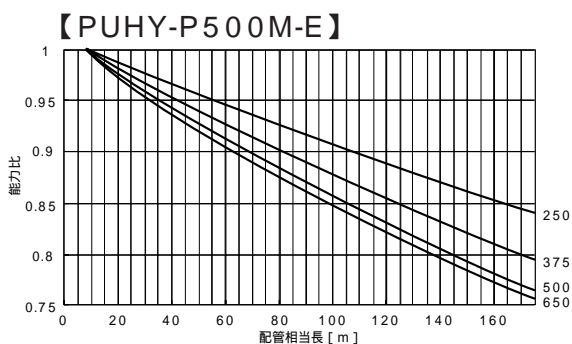

【暖房能力補正係数】

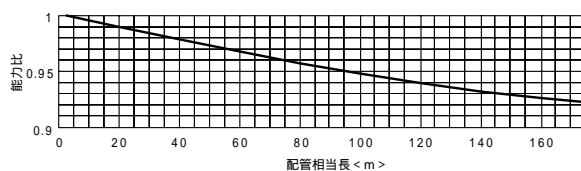

【配管相当長の求め方】

- (1) PUHY-P500M-E形 相当長 = (最遠室内ユニットまでの配管実長) + (0.5 × 配管途中のベンド数) m
- (2) PUHY-P560M-E形 相当長 = (最遠室内ユニットまでの配管実長) + (0.5 × 配管途中のベンド数) m
- (3) PUHY-P630M-E形 相当長 = (最遠室内ユニットまでの配管実長) + (0.5 × 配管途中のベンド数) m
- (4) PUHY-P674M-E形 相当長 = (最遠室内ユニットまでの配管実長) + (0.5 × 配管途中のベンド数) m
- (5) PUHY-P730M-E形 相当長 = (最遠室内ユニットまでの配管実長) + (0.5 × 配管途中のベンド数) m

d. 霜取補正

室外吸込空気温度 < 湿球温度 >		6	4	2	1	0	-2	-4	-6	-8	-10
霜取補正係数	P500形	1.0	0.98	0.89	0.86	0.89	0.90	0.92	0.95	0.95	0.95
	P560形	1.0	0.98	0.89	0.86	0.89	0.90	0.92	0.95	0.95	0.95
	P630形	1.0	0.94	0.87	0.86	0.87	0.88	0.90	0.90	0.93	0.93
	P674形	1.0	0.94	0.84	0.86	0.87	0.88	0.90	0.90	0.93	0.93
	P730形	1.0	0.94	0.84	0.86	0.87	0.88	0.90	0.90	0.93	0.93

P784~P900M-E形

a. 標準能力表

【PUHY-P784SM-E】

室内ユニット 合計容量	能力 (kW)		入力 (kW)	
	冷房	暖房	冷房	暖房
392	39.2	42.0	9.10	10.79
393	39.3	43.0	9.13	10.81
394	39.4	44.0	9.15	10.84
395	39.5	44.0	9.18	10.86
396	39.6	44.0	9.21	10.89
397	39.7	44.2	9.24	10.91
398	39.8	44.3	9.26	10.94
399	39.9	44.5	9.29	10.96
400	40.0	44.5	9.32	10.99
401	40.1	44.7	9.34	11.01
402	40.2	44.8	9.37	11.04
403	40.3	45.0	9.40	11.06
404	40.4	45.0	9.43	11.09
405	40.5	45.0	9.45	11.12
406	40.6	45.2	9.48	11.14
407	40.7	45.3	9.51	11.17
408	40.8	45.5	9.53	11.19
409	40.9	45.5	9.56	11.22
410	41.0	45.7	9.59	11.24
411	41.1	45.8	9.62	11.27
412	41.2	46.0	9.64	11.29
413	41.3	46.0	9.67	11.32
414	41.4	46.0	9.70	11.34
415	41.5	46.2	9.73	11.37
416	41.6	46.3	9.75	11.39
417	41.7	46.5	9.78	11.42
418	41.8	46.5	9.81	11.45
419	41.9	46.7	9.84	11.47
420	42.0	46.8	9.86	11.50
421	42.1	47.0	9.89	11.52
422	42.2	47.0	9.92	11.55
423	42.3	47.0	9.95	11.57
424	42.4	47.2	9.98	11.60
425	42.5	47.3	10.00	11.62
426	42.6	47.5	10.03	11.65
427	42.7	47.5	10.06	11.68
428	42.8	47.7	10.09	11.70
429	42.9	47.8	10.11	11.73
430	43.0	48.0	10.14	11.75
431	43.1	48.0	10.17	11.78
432	43.2	48.0	10.20	11.80
433	43.3	48.2	10.23	11.83
434	43.4	48.3	10.25	11.86
435	43.5	48.5	10.28	11.88
436	43.6	48.5	10.31	11.91
437	43.7	48.7	10.34	11.93
438	43.8	48.8	10.37	11.96
439	43.9	49.0	10.39	11.98
440	44.0	49.0	10.42	12.01
441	44.1	49.0	10.45	12.04
442	44.2	49.2	10.48	12.06
443	44.3	49.3	10.51	12.09
444	44.4	49.5	10.54	12.11
445	44.5	49.5	10.56	12.14
446	44.6	49.7	10.59	12.17
447	44.7	49.8	10.62	12.19
448	44.8	50.0	10.65	12.22
449	44.9	50.0	10.68	12.24
450	45.0	50.0	10.71	12.27
451	45.1	50.2	10.73	12.30
452	45.2	50.3	10.76	12.32
453	45.3	50.5	10.79	12.35
454	45.4	50.5	10.82	12.37
455	45.5	50.7	10.85	12.40
456	45.6	50.8	10.88	12.43
457	45.7	51.0	10.91	12.45
458	45.8	51.0	10.93	12.48
459	45.9	51.0	10.96	12.50
460	46.0	51.2	10.99	12.53
461	46.1	51.3	11.02	12.56

室内ユニット 合計容量	能力 (kW)		入力 (kW)	
	冷房	暖房	冷房	暖房
462	46.2	51.5	11.05	12.58
463	46.3	51.5	11.08	12.61
464	46.4	51.7	11.11	12.64
465	46.5	51.8	11.14	12.66
466	46.6	52.0	11.16	12.69
467	46.7	52.0	11.19	12.71
468	46.8	52.0	11.22	12.74
469	46.9	52.2	11.25	12.77
470	47.0	52.3	11.28	12.79
471	47.1	52.5	11.31	12.82
472	47.2	52.5	11.34	12.85
473	47.3	52.7	11.37	12.87
474	47.4	52.8	11.40	12.90
475	47.5	53.0	11.43	12.92
476	47.6	53.0	11.46	12.95
477	47.7	53.0	11.48	12.98
478	47.8	53.2	11.51	13.00
479	47.9	53.3	11.54	13.03
480	48.0	53.5	11.57	13.06
481	48.1	53.5	11.60	13.08
482	48.2	53.7	11.63	13.11
483	48.3	53.8	11.66	13.14
484	48.4	54.0	11.69	13.16
485	48.5	54.0	11.72	13.19
486	48.6	54.0	11.75	13.22
487	48.7	54.2	11.78	13.24
488	48.8	54.3	11.81	13.27
489	48.9	54.5	11.84	13.30
490	49.0	54.5	11.87	13.32
491	49.1	54.7	11.90	13.35
492	49.2	54.8	11.93	13.38
493	49.3	55.0	11.95	13.40
494	49.4	55.0	11.98	13.43
495	49.5	55.0	12.01	13.46
496	49.6	55.2	12.04	13.48
497	49.7	55.3	12.07	13.51
498	49.8	55.5	12.10	13.54
499	49.9	55.5	12.13	13.56
500	50.0	55.7	12.16	13.59
501	50.1	55.8	12.19	13.62
502	50.2	56.0	12.22	13.64
503	50.3	56.0	12.25	13.67
504	50.4	56.0	12.28	13.70
505	50.5	56.2	12.31	13.72
506	50.6	56.3	12.34	13.75
507	50.7	56.5	12.37	13.78
508	50.8	56.5	12.40	13.80
509	50.9	56.7	12.43	13.83
510	51.0	56.8	12.46	13.86
511	51.1	57.0	12.49	13.89
512	51.2	57.0	12.52	13.91
513	51.3	57.0	12.55	13.94
514	51.4	57.2	12.58	13.97
515	51.5	57.3	12.61	13.99
516	51.6	57.5	12.64	14.02
517	51.7	57.5	12.67	14.05
518	51.8	57.7	12.70	14.07
519	51.9	57.8	12.73	14.10
520	52.0	58.0	12.77	14.13
521	52.1	58.0	12.80	14.16
522	52.2	58.0	12.83	14.18
523	52.3	58.2	12.86	14.21
524	52.4	58.3	12.89	14.24
525	52.5	58.5	12.92	14.26
526	52.6	58.5	12.95	14.29
527	52.7	58.7	12.98	14.32
528	52.8	58.8	13.01	14.35
529	52.9	59.0	13.04	14.37
530	53.0	59.0	13.07	14.40
531	53.1	59.0	13.10	14.43

室内ユニット 合計容量	能力 (kW)		入力 (kW)	
	冷房	暖房	冷房	暖房
532	53.2	59.2	13.13	14.45
533	53.3	59.3	13.16	14.48
534	53.4	59.5	13.19	14.51
535	53.5	59.5	13.22	14.54
536	53.6	59.7	13.25	14.56
537	53.7	59.8	13.29	14.59
538	53.8	60.0	13.32	14.62
539	53.9	60.0	13.35	14.65
540	54.0	60.0	13.38	14.67
541	54.1	60.2	13.41	14.70
542	54.2	60.3	13.44	14.73
543	54.3	60.5	13.47	14.76
544	54.4	60.5	13.50	14.78
545	54.5	60.7	13.53	14.81
546	54.6	60.8	13.56	14.84
547	54.7	61.0	13.60	14.87
548	54.8	61.0	13.63	14.89
549	54.9	61.0	13.66	14.92
550	55.0	61.2	13.69	14.95
551	55.1	61.3	13.72	14.98
552	55.2	61.5	13.75	15.00
553	55.3	61.5	13.78	15.03
554	55.4	61.7	13.81	15.06
555	55.5	61.8	13.85	15.09
556	55.6	62.0	13.88	15.11
557	55.7	62.0	13.91	15.14
558	55.8	62.0	13.94	15.17
559	55.9	62.2	13.97	15.20
560	56.0	62.3	14.00	15.22
561	56.1	62.5	14.03	15.25
562	56.2	62.5	14.07	15.28
563	56.3	62.7	14.10	15.31
564	56.4	62.8	14.13	15.34
565	56.5	63.0	14.16	15.36
566	56.6	63.0	14.19	15.39
567	56.7	63.0	14.22	15.42
568	56.8	63.2	14.25	15.45
569	56.9	63.3	14.29	15.47
570	57.0	63.5	14.32	15.50
571	57.1	63.5	14.35	15.53
572	57.2	63.7	14.38	15.56
573	57.3	63.8	14.41	15.59
574	57.4	64.0	14.45	15.61
575	57.5	64.0	14.48	15.64
576	57.6	64.0	14.51	15.67
577	57.7	64.2	14.54	15.70
578	57.8	64.3	14.57	15.73
579	57.9	64.5	14.61	15.75
580	58.0	64.5	14.64	15.78
581	58.1	64.7	14.67	15.81
582	58.2	64.8	14.70	15.84
583	58.3	65.0	14.73	15.87
584	58.4	65.0	14.77	15.89
585	58.5	65.0	14.80	15.92
586	58.6	65.2	14.83	15.95
587	58.7	65.3	14.86	15.98
588	58.8	65.5	14.89	16.01
589	58.9	65.5	14.93	16.04
590	59.0	65.7	14.96	16.06
591	59.1	65.8	14.99	16.09
592	59.2	66.0	15.02	16.12
593	59.3	66.0	15.06	16.15
594	59.4	66.0	15.09	16.18
595	59.5	66.2	15.12	16.20
596	59.6	66.3	15.15	16.23
597	59.7	66.5	15.19	16.26
598	59.8	66.5	15.22	16.29
599	59.9	66.7	15.25	16.32
600	60.0	66.8	15.28	16.35
601	60.1	67.0	15.32	16.37

【PUHY-P784SM-E】

室内ユニット 合計容量	能力 (kW)		入力 (kW)	
	冷房	暖房	冷房	暖房
602	60.2	67.0	15.35	16.40
603	60.3	67.0	15.38	16.43
604	60.4	67.2	15.41	16.46
605	60.5	67.3	15.45	16.49
606	60.6	67.5	15.48	16.52
607	60.7	67.5	15.51	16.55
608	60.8	67.7	15.54	16.57
609	60.9	67.8	15.58	16.60
610	61.0	68.0	15.61	16.63
611	61.1	68.0	15.64	16.66
612	61.2	68.0	15.68	16.69
613	61.3	68.2	15.71	16.72
614	61.4	68.3	15.74	16.74
615	61.5	68.5	15.77	16.77
616	61.6	68.5	15.81	16.80
617	61.7	68.7	15.84	16.83
618	61.8	68.8	15.87	16.86
619	61.9	69.0	15.91	16.89
620	62.0	69.0	15.94	16.92
621	62.1	69.0	15.97	16.95
622	62.2	69.2	16.01	16.97
623	62.3	69.3	16.04	17.00
624	62.4	69.5	16.07	17.03
625	62.5	69.5	16.11	17.06
626	62.6	69.7	16.14	17.09
627	62.7	69.8	16.17	17.12
628	62.8	70.0	16.21	17.15
629	62.9	70.0	16.24	17.17
630	63.0	70.0	16.27	17.20
631	63.1	70.2	16.31	17.23
632	63.2	70.3	16.34	17.26
633	63.3	70.5	16.37	17.29
634	63.4	70.5	16.41	17.32
635	63.5	70.7	16.44	17.35
636	63.6	70.8	16.47	17.38
637	63.7	71.0	16.51	17.41
638	63.8	71.0	16.54	17.43
639	63.9	71.0	16.57	17.46
640	64.0	71.2	16.61	17.49
641	64.1	71.3	16.64	17.52
642	64.2	71.5	16.67	17.55
643	64.3	71.5	16.71	17.58
644	64.4	71.7	16.74	17.61
645	64.5	71.8	16.78	17.64
646	64.6	72.0	16.81	17.67
647	64.7	72.0	16.84	17.70
648	64.8	72.0	16.88	17.72
649	64.9	72.2	16.91	17.75
650	65.0	72.3	16.95	17.78
651	65.1	72.5	16.98	17.81
652	65.2	72.5	17.01	17.84
653	65.3	72.7	17.05	17.87
654	65.4	72.8	17.08	17.90
655	65.5	73.0	17.12	17.93
656	65.6	73.0	17.15	17.96
657	65.7	73.0	17.18	17.99
658	65.8	73.2	17.22	18.02
659	65.9	73.3	17.25	18.05
660	66.0	73.5	17.29	18.08
661	66.1	73.5	17.32	18.10
662	66.2	73.7	17.35	18.13
663	66.3	73.8	17.39	18.16
664	66.4	74.0	17.42	18.19
665	66.5	74.0	17.46	18.22
666	66.6	74.0	17.49	18.25
667	66.7	74.2	17.53	18.28
668	66.8	74.3	17.56	18.31
669	66.9	74.5	17.60	18.34
670	67.0	74.5	17.63	18.37
671	67.1	74.7	17.66	18.40

室内ユニット 合計容量	能力 (kW)		入力 (kW)	
	冷房	暖房	冷房	暖房
672	67.2	74.8	17.70	18.43
673	67.3	75.0	17.73	18.46
674	67.4	75.0	17.77	18.49
675	67.5	75.0	17.80	18.52
676	67.6	75.2	17.84	18.55
677	67.7	75.3	17.87	18.58
678	67.8	75.5	17.91	18.60
679	67.9	75.5	17.94	18.63
680	68.0	75.7	17.98	18.66
681	68.1	75.8	18.01	18.69
682	68.2	76.0	18.05	18.72
683	68.3	76.0	18.08	18.75
684	68.4	76.0	18.11	18.78
685	68.5	76.2	18.15	18.81
686	68.6	76.3	18.18	18.84
687	68.7	76.5	18.22	18.87
688	68.8	76.5	18.25	18.90
689	68.9	76.7	18.29	18.93
690	69.0	76.8	18.32	18.96
691	69.1	77.0	18.36	18.99
692	69.2	77.0	18.39	19.02
693	69.3	77.0	18.43	19.05
694	69.4	77.2	18.46	19.08
695	69.5	77.3	18.50	19.11
696	69.6	77.5	18.54	19.14
697	69.7	77.5	18.57	19.17
698	69.8	77.7	18.61	19.20
699	69.9	77.8	18.64	19.23
700	70.0	78.0	18.68	19.26
701	70.1	78.0	18.71	19.29
702	70.2	78.0	18.75	19.32
703	70.3	78.2	18.78	19.35
704	70.4	78.3	18.82	19.38
705	70.5	78.5	18.85	19.41
706	70.6	78.5	18.89	19.44
707	70.7	78.7	18.92	19.47
708	70.8	78.8	18.96	19.50
709	70.9	79.0	19.00	19.53
710	71.0	79.0	19.03	19.56
711	71.1	79.0	19.07	19.59
712	71.2	79.2	19.10	19.62
713	71.3	79.3	19.14	19.65
714	71.4	79.5	19.17	19.68
715	71.5	79.5	19.21	19.71
716	71.6	79.7	19.24	19.74
717	71.7	79.8	19.28	19.77
718	71.8	80.0	19.32	19.80
719	71.9	80.0	19.35	19.83
720	72.0	80.0	19.39	19.86
721	72.1	80.2	19.42	19.89
722	72.2	80.3	19.46	19.92
723	72.3	80.5	19.50	19.95
724	72.4	80.5	19.53	19.98
725	72.5	80.7	19.57	20.01
726	72.6	80.8	19.60	20.04
727	72.7	81.0	19.64	20.07
728	72.8	81.0	19.68	20.10
729	72.9	81.0	19.71	20.13
730	73.0	81.2	19.75	20.16
731	73.1	81.3	19.78	20.19
732	73.2	81.5	19.82	20.22
733	73.3	81.5	19.86	20.25
734	73.4	81.7	19.89	20.28
735	73.5	81.8	19.93	20.32
736	73.6	82.0	19.96	20.35
737	73.7	82.0	20.00	20.38
738	73.8	82.0	20.04	20.41
739	73.9	82.2	20.07	20.44
740	74.0	82.3	20.11	20.47
741	74.1	82.5	20.15	20.50

室内ユニット 合計容量	能力 (kW)		入力 (kW)	
	冷房	暖房	冷房	暖房
742	74.2	82.5	20.18	20.53
743	74.3	82.7	20.22	20.56
744	74.4	82.8	20.26	20.59
745	74.5	83.0	20.29	20.62
746	74.6	83.0	20.33	20.65
747	74.7	83.0	20.37	20.68
748	74.8	83.2	20.40	20.71
749	74.9	83.3	20.44	20.74
750	75.0	83.5	20.48	20.77
751	75.1	83.5	20.51	20.80
752	75.2	83.7	20.55	20.84
753	75.3	83.8	20.59	20.87
754	75.4	84.0	20.62	20.90
755	75.5	84.0	20.66	20.93
756	75.6	84.0	20.70	20.96
757	75.7	84.2	20.73	20.99
758	75.8	84.3	20.77	21.02
759	75.9	84.5	20.81	21.05
760	76.0	84.5	20.84	21.08
761	76.1	84.7	20.88	21.11
762	76.2	84.8	20.92	21.14
763	76.3	85.0	20.95	21.17
764	76.4	85.0	20.99	21.21
765	76.5	85.0	21.03	21.24
766	76.6	85.2	21.07	21.27
767	76.7	85.3	21.10	21.30
768	76.8	85.5	21.14	21.33
769	76.9	85.5	21.18	21.36
770	77.0	85.7	21.21	21.39
771	77.1	85.8	21.25	21.42
772	77.2	86.0	21.29	21.45
773	77.3	86.0	21.33	21.48
774	77.4	86.0	21.36	21.51
775	77.5	86.2	21.40	21.55
776	77.6	86.3	21.44	21.58
777	77.7	86.5	21.48	21.61
778	77.8	86.5	21.51	21.64
779	77.9	86.7	21.55	21.67
780	78.0	86.8	21.59	21.70
781	78.1	87.0	21.63	21.73
782	78.2	87.0	21.66	21.76
783	78.3	87.0	21.70	21.80
784	78.4	88.0	21.70	21.83
785	78.4	88.0	21.70	21.82
786	78.5	88.0	21.70	21.82
787	78.5	88.0	21.70	21.81
788	78.5	88.0	21.70	21.81
789	78.5	88.0	21.70	21.80
790	78.6	88.0	21.70	21.79
791	78.6	88.0	21.70	21.79
792	78.6	88.0	21.70	21.78
793	78.6	88.0	21.70	21.77
794	78.7	88.0	21.70	21.77
795	78.7	88.0	21.70	21.76
796	78.7	88.0	21.70	21.75
797	78.7	88.0	21.70	21.75
798	78.8	88.0	21.70	21.74
799	78.8	88.0	21.70	21.73
800	78.8	88.0	21.70	21.73
801	78.9	88.0	21.70	21.72
802	78.9	88.0	21.70	21.71
803	78.9	88.0	21.70	21.71
804	78.9	88.0	21.70	21.70
805	79.0	88.0	21.70	21.70
806	79.0	88.0	21.70	21.69
807	79.0	88.0	21.70	21.68
808	79.0	88.0	21.71	21.68
809	79.1	88.0	21.71	21.67
810	79.1	88.0	21.71	21.66
811	79.1	88.0	21.71	21.66

【PUHY-P784SM-E】

室内ユニット 合計容量	能力 (kW)		入力 (kW)	
	冷房	暖房	冷房	暖房
812	79.2	88.0	21.71	21.65
813	79.2	88.0	21.71	21.64
814	79.2	88.0	21.71	21.64
815	79.2	88.0	21.71	21.63
816	79.3	88.0	21.71	21.62
817	79.3	88.0	21.71	21.62
818	79.3	88.0	21.71	21.61
819	79.3	88.0	21.71	21.60
820	79.4	88.0	21.71	21.60
821	79.4	88.0	21.71	21.59
822	79.4	88.0	21.71	21.59
823	79.4	88.0	21.71	21.58
824	79.5	88.0	21.71	21.57
825	79.5	88.0	21.71	21.57
826	79.5	88.1	21.71	21.56
827	79.6	88.1	21.71	21.55
828	79.6	88.1	21.71	21.55
829	79.6	88.1	21.71	21.54
830	79.6	88.1	21.71	21.53
831	79.7	88.1	21.71	21.53
832	79.7	88.1	21.71	21.52
833	79.7	88.1	21.71	21.51
834	79.7	88.1	21.71	21.51
835	79.8	88.1	21.71	21.50
836	79.8	88.1	21.72	21.49
837	79.8	88.1	21.72	21.49
838	79.8	88.1	21.72	21.48
839	79.9	88.1	21.72	21.47
840	79.9	88.1	21.72	21.47
841	79.9	88.1	21.72	21.46
842	80.0	88.1	21.72	21.46
843	80.0	88.1	21.72	21.45
844	80.0	88.1	21.72	21.44
845	80.0	88.1	21.72	21.44
846	80.1	88.1	21.72	21.43
847	80.1	88.1	21.72	21.42
848	80.1	88.1	21.72	21.42
849	80.1	88.1	21.72	21.41
850	80.2	88.1	21.72	21.40
851	80.2	88.1	21.72	21.40
852	80.2	88.1	21.72	21.39
853	80.2	88.1	21.72	21.38
854	80.3	88.1	21.72	21.38
855	80.3	88.1	21.72	21.37
856	80.3	88.1	21.72	21.36
857	80.4	88.1	21.72	21.36
858	80.4	88.1	21.72	21.35
859	80.4	88.1	21.72	21.35
860	80.4	88.1	21.72	21.34
861	80.5	88.1	21.72	21.33
862	80.5	88.1	21.72	21.33
863	80.5	88.1	21.73	21.32
864	80.5	88.1	21.73	21.31
865	80.6	88.1	21.73	21.31
866	80.6	88.1	21.73	21.30
867	80.6	88.1	21.73	21.29
868	80.7	88.1	21.73	21.29
869	80.7	88.1	21.73	21.28
870	80.7	88.1	21.73	21.27
871	80.7	88.1	21.73	21.27
872	80.8	88.1	21.73	21.26
873	80.8	88.1	21.73	21.25
874	80.8	88.1	21.73	21.25
875	80.8	88.1	21.73	21.24
876	80.9	88.1	21.73	21.24
877	80.9	88.1	21.73	21.23
878	80.9	88.1	21.73	21.22
879	80.9	88.1	21.73	21.22
880	81.0	88.1	21.73	21.21
881	81.0	88.1	21.73	21.20

室内ユニット 合計容量	能力 (kW)		入力 (kW)	
	冷房	暖房	冷房	暖房
882	81.0	88.1	21.73	21.20
883	81.1	88.1	21.73	21.19
884	81.1	88.1	21.73	21.18
885	81.1	88.1	21.73	21.18
886	81.1	88.1	21.73	21.17
887	81.2	88.1	21.73	21.16
888	81.2	88.1	21.73	21.16
889	81.2	88.1	21.73	21.15
890	81.2	88.1	21.74	21.14
891	81.3	88.1	21.74	21.14
892	81.3	88.1	21.74	21.13
893	81.3	88.1	21.74	21.13
894	81.3	88.1	21.74	21.12
895	81.4	88.1	21.74	21.11
896	81.4	88.1	21.74	21.11
897	81.4	88.1	21.74	21.10
898	81.5	88.1	21.74	21.09
899	81.5	88.1	21.74	21.09
900	81.5	88.1	21.74	21.08
901	81.5	88.1	21.74	21.07
902	81.6	88.1	21.74	21.07
903	81.6	88.1	21.74	21.06
904	81.6	88.1	21.74	21.05
905	81.6	88.1	21.74	21.05
906	81.7	88.1	21.74	21.04
907	81.7	88.1	21.74	21.03
908	81.7	88.1	21.74	21.03
909	81.8	88.2	21.74	21.02
910	81.8	88.2	21.74	21.02
911	81.8	88.2	21.74	21.01
912	81.8	88.2	21.74	21.00
913	81.9	88.2	21.74	21.00
914	81.9	88.2	21.74	20.99
915	81.9	88.2	21.74	20.98
916	81.9	88.2	21.74	20.98
917	82.0	88.2	21.74	20.97
918	82.0	88.2	21.75	20.96
919	82.0	88.2	21.75	20.96
920	82.0	88.2	21.75	20.95
921	82.1	88.2	21.75	20.94
922	82.1	88.2	21.75	20.94
923	82.1	88.2	21.75	20.93
924	82.2	88.2	21.75	20.92
925	82.2	88.2	21.75	20.92
926	82.2	88.2	21.75	20.91
927	82.2	88.2	21.75	20.90
928	82.3	88.2	21.75	20.90
929	82.3	88.2	21.75	20.89
930	82.3	88.2	21.75	20.89
931	82.3	88.2	21.75	20.88
932	82.4	88.2	21.75	20.87
933	82.4	88.2	21.75	20.87
934	82.4	88.2	21.75	20.86
935	82.4	88.2	21.75	20.85
936	82.5	88.2	21.75	20.85
937	82.5	88.2	21.75	20.84
938	82.5	88.2	21.75	20.83
939	82.6	88.2	21.75	20.83
940	82.6	88.2	21.75	20.82
941	82.6	88.2	21.75	20.81
942	82.6	88.2	21.75	20.81
943	82.7	88.2	21.75	20.80
944	82.7	88.2	21.75	20.79
945	82.7	88.2	21.76	20.79
946	82.7	88.2	21.76	20.78
947	82.8	88.2	21.76	20.78
948	82.8	88.2	21.76	20.77
949	82.8	88.2	21.76	20.76
950	82.8	88.2	21.76	20.76
951	82.9	88.2	21.76	20.75

室内ユニット 合計容量	能力 (kW)		入力 (kW)	
	冷房	暖房	冷房	暖房
952	82.9	88.2	21.76	20.74
953	82.9	88.2	21.76	20.74
954	83.0	88.2	21.76	20.73
955	83.0	88.2	21.76	20.72
956	83.0	88.2	21.76	20.72
957	83.0	88.2	21.76	20.71
958	83.1	88.2	21.76	20.70
959	83.1	88.2	21.76	20.70
960	83.1	88.2	21.76	20.69
961	83.1	88.2	21.76	20.68
962	83.2	88.2	21.76	20.68
963	83.2	88.2	21.76	20.67
964	83.2	88.2	21.76	20.67
965	83.3	88.2	21.76	20.66
966	83.3	88.2	21.76	20.65
967	83.3	88.2	21.76	20.65
968	83.3	88.2	21.76	20.64
969	83.4	88.2	21.76	20.63
970	83.4	88.2	21.76	20.63
971	83.4	88.2	21.76	20.62
972	83.4	88.2	21.76	20.61
973	83.5	88.2	21.77	20.61
974	83.5	88.2	21.77	20.60
975	83.5	88.2	21.77	20.59
976	83.5	88.2	21.77	20.59
977	83.6	88.2	21.77	20.58
978	83.6	88.2	21.77	20.57
979	83.6	88.2	21.77	20.57
980	83.7	88.2	21.77	20.56
981	83.7	88.2	21.77	20.56
982	83.7	88.2	21.77	20.55
983	83.7	88.2	21.77	20.54
984	83.8	88.2	21.77	20.54
985	83.8	88.2	21.77	20.53
986	83.8	88.2	21.77	20.52
987	83.8	88.2	21.77	20.52
988	83.9	88.2	21.77	20.51
989	83.9	88.2	21.77	20.50
990	83.9	88.2	21.77	20.50
991	83.9	88.2	21.77	20.49
992	84.0	88.2	21.77	20.48
993	84.0	88.3	21.77	20.48
994	84.0	88.3	21.77	20.47
995	84.1	88.3	21.77	20.46
996	84.1	88.3	21.77	20.46
997	84.1	88.3	21.77	20.45
998	84.1	88.3	21.77	20.44
999	84.2	88.3	21.77	20.44
1000	84.2	88.3	21.78	20.43
1001	84.2	88.3	21.78	20.43
1002	84.2	88.3	21.78	20.42
1003	84.3	88.3	21.78	20.41
1004	84.3	88.3	21.78	20.41
1005	84.3	88.3	21.78	20.40
1006	84.3	88.3	21.78	20.39
1007	84.4	88.3	21.78	20.39
1008	84.4	88.3	21.78	20.38
1009	84.4	88.3	21.78	20.37
1010	84.5	88.3	21.78	20.37
1011	84.5	88.3	21.78	20.36
1012	84.5	88.3	21.78	20.35
1013	84.5	88.3	21.78	20.35
1014	84.6	88.3	21.78	20.34
1015	84.6	88.3	21.78	20.33
1016	84.6	88.3	21.78	20.33
1017	84.6	88.3	21.78	20.32
1018	84.7	88.3	21.78	20.32
1019	84.7	88.3	21.78	20.31

【PUHY-P840SM-E】

室内ユニット 合計容量	能力 (kW)		入力 (kW)	
	冷房	暖房	冷房	暖房
420	42.0	46.8	9.88	11.89
421	42.1	47.0	9.91	11.91
422	42.2	47.0	9.94	11.94
423	42.3	47.0	9.97	11.96
424	42.4	47.2	10.00	11.99
425	42.5	47.3	10.02	12.02
426	42.6	47.5	10.05	12.04
427	42.7	47.5	10.08	12.07
428	42.8	47.7	10.11	12.09
429	42.9	47.8	10.14	12.12
430	43.0	48.0	10.17	12.14
431	43.1	48.0	10.19	12.17
432	43.2	48.0	10.22	12.19
433	43.3	48.2	10.25	12.22
434	43.4	48.3	10.28	12.24
435	43.5	48.5	10.31	12.27
436	43.6	48.5	10.34	12.30
437	43.7	48.7	10.37	12.32
438	43.8	48.8	10.40	12.35
439	43.9	49.0	10.42	12.37
440	44.0	49.0	10.45	12.40
441	44.1	49.0	10.48	12.42
442	44.2	49.2	10.51	12.45
443	44.3	49.3	10.54	12.47
444	44.4	49.5	10.57	12.50
445	44.5	49.5	10.60	12.53
446	44.6	49.7	10.63	12.55
447	44.7	49.8	10.66	12.58
448	44.8	50.0	10.69	12.60
449	44.9	50.0	10.72	12.63
450	45.0	50.0	10.75	12.65
451	45.1	50.2	10.77	12.68
452	45.2	50.3	10.80	12.71
453	45.3	50.5	10.83	12.73
454	45.4	50.5	10.86	12.76
455	45.5	50.7	10.89	12.78
456	45.6	50.8	10.92	12.81
457	45.7	51.0	10.95	12.83
458	45.8	51.0	10.98	12.86
459	45.9	51.0	11.01	12.89
460	46.0	51.2	11.04	12.91
461	46.1	51.3	11.07	12.94
462	46.2	51.5	11.10	12.96
463	46.3	51.5	11.13	12.99
464	46.4	51.7	11.16	13.02
465	46.5	51.8	11.19	13.04
466	46.6	52.0	11.22	13.07
467	46.7	52.0	11.25	13.09
468	46.8	52.0	11.28	13.12
469	46.9	52.2	11.31	13.15
470	47.0	52.3	11.34	13.17
471	47.1	52.5	11.37	13.20
472	47.2	52.5	11.40	13.22
473	47.3	52.7	11.43	13.25
474	47.4	52.8	11.46	13.28
475	47.5	53.0	11.49	13.30
476	47.6	53.0	11.52	13.33
477	47.7	53.0	11.55	13.36
478	47.8	53.2	11.58	13.38
479	47.9	53.3	11.61	13.41
480	48.0	53.5	11.64	13.43
481	48.1	53.5	11.67	13.46
482	48.2	53.7	11.70	13.49
483	48.3	53.8	11.73	13.51
484	48.4	54.0	11.76	13.54
485	48.5	54.0	11.79	13.57
486	48.6	54.0	11.82	13.59
487	48.7	54.2	11.85	13.62
488	48.8	54.3	11.88	13.64
489	48.9	54.5	11.91	13.67

室内ユニット 合計容量	能力 (kW)		入力 (kW)	
	冷房	暖房	冷房	暖房
490	49.0	54.5	11.95	13.70
491	49.1	54.7	11.98	13.72
492	49.2	54.8	12.01	13.75
493	49.3	55.0	12.04	13.78
494	49.4	55.0	12.07	13.80
495	49.5	55.0	12.10	13.83
496	49.6	55.2	12.13	13.86
497	49.7	55.3	12.16	13.88
498	49.8	55.5	12.19	13.91
499	49.9	55.5	12.22	13.94
500	50.0	55.7	12.25	13.96
501	50.1	55.8	12.29	13.99
502	50.2	56.0	12.32	14.02
503	50.3	56.0	12.35	14.04
504	50.4	56.0	12.38	14.07
505	50.5	56.2	12.41	14.10
506	50.6	56.3	12.44	14.12
507	50.7	56.5	12.47	14.15
508	50.8	56.5	12.50	14.18
509	50.9	56.7	12.54	14.20
510	51.0	56.8	12.57	14.23
511	51.1	57.0	12.60	14.26
512	51.2	57.0	12.63	14.29
513	51.3	57.0	12.66	14.31
514	51.4	57.2	12.69	14.34
515	51.5	57.3	12.72	14.37
516	51.6	57.5	12.76	14.39
517	51.7	57.5	12.79	14.42
518	51.8	57.7	12.82	14.45
519	51.9	57.8	12.85	14.48
520	52.0	58.0	12.88	14.50
521	52.1	58.0	12.91	14.53
522	52.2	58.0	12.95	14.56
523	52.3	58.2	12.98	14.58
524	52.4	58.3	13.01	14.61
525	52.5	58.5	13.04	14.64
526	52.6	58.5	13.07	14.67
527	52.7	58.7	13.11	14.69
528	52.8	58.8	13.14	14.72
529	52.9	59.0	13.17	14.75
530	53.0	59.0	13.20	14.78
531	53.1	59.0	13.23	14.80
532	53.2	59.2	13.27	14.83
533	53.3	59.3	13.30	14.86
534	53.4	59.5	13.33	14.89
535	53.5	59.5	13.36	14.91
536	53.6	59.7	13.40	14.94
537	53.7	59.8	13.43	14.97
538	53.8	60.0	13.46	15.00
539	53.9	60.0	13.49	15.02
540	54.0	60.0	13.53	15.05
541	54.1	60.2	13.56	15.08
542	54.2	60.3	13.59	15.11
543	54.3	60.5	13.62	15.14
544	54.4	60.5	13.66	15.16
545	54.5	60.7	13.69	15.19
546	54.6	60.8	13.72	15.22
547	54.7	61.0	13.75	15.25
548	54.8	61.0	13.79	15.27
549	54.9	61.0	13.82	15.30
550	55.0	61.2	13.85	15.33
551	55.1	61.3	13.88	15.36
552	55.2	61.5	13.92	15.39
553	55.3	61.5	13.95	15.42
554	55.4	61.7	13.98	15.44
555	55.5	61.8	14.02	15.47
556	55.6	62.0	14.05	15.50
557	55.7	62.0	14.08	15.53
558	55.8	62.0	14.12	15.56
559	55.9	62.2	14.15	15.58

室内ユニット 合計容量	能力 (kW)		入力 (kW)	
	冷房	暖房	冷房	暖房
560	56.0	62.3	14.18	15.61
561	56.1	62.5	14.22	15.64
562	56.2	62.5	14.25	15.67
563	56.3	62.7	14.28	15.70
564	56.4	62.8	14.32	15.73
565	56.5	63.0	14.35	15.76
566	56.6	63.0	14.38	15.78
567	56.7	63.0	14.42	15.81
568	56.8	63.2	14.45	15.84
569	56.9	63.3	14.48	15.87
570	57.0	63.5	14.52	15.90
571	57.1	63.5	14.55	15.93
572	57.2	63.7	14.58	15.96
573	57.3	63.8	14.62	15.98
574	57.4	64.0	14.65	16.01
575	57.5	64.0	14.68	16.04
576	57.6	64.0	14.72	16.07
577	57.7	64.2	14.75	16.10
578	57.8	64.3	14.79	16.13
579	57.9	64.5	14.82	16.16
580	58.0	64.5	14.85	16.19
581	58.1	64.7	14.89	16.22
582	58.2	64.8	14.92	16.25
583	58.3	65.0	14.96	16.27
584	58.4	65.0	14.99	16.30
585	58.5	65.0	15.02	16.33
586	58.6	65.2	15.06	16.36
587	58.7	65.3	15.09	16.39
588	58.8	65.5	15.13	16.42
589	58.9	65.5	15.16	16.45
590	59.0	65.7	15.19	16.48
591	59.1	65.8	15.23	16.51
592	59.2	66.0	15.26	16.54
593	59.3	66.0	15.30	16.57
594	59.4	66.0	15.33	16.60
595	59.5	66.2	15.37	16.63
596	59.6	66.3	15.40	16.66
597	59.7	66.5	15.44	16.69
598	59.8	66.5	15.47	16.72
599	59.9	66.7	15.50	16.75
600	60.0	66.8	15.54	16.78
601	60.1	67.0	15.57	16.80
602	60.2	67.0	15.61	16.83
603	60.3	67.0	15.64	16.86
604	60.4	67.2	15.68	16.89
605	60.5	67.3	15.71	16.92
606	60.6	67.5	15.75	16.95
607	60.7	67.5	15.78	16.98
608	60.8	67.7	15.82	17.01
609	60.9	67.8	15.85	17.04
610	61.0	68.0	15.89	17.07
611	61.1	68.0	15.92	17.10
612	61.2	68.0	15.96	17.14
613	61.3	68.2	15.99	17.17
614	61.4	68.3	16.03	17.20
615	61.5	68.5	16.06	17.23
616	61.6	68.5	16.10	17.26
617	61.7	68.7	16.13	17.29
618	61.8	68.8	16.17	17.32
619	61.9	69.0	16.20	17.35
620	62.0	69.0	16.24	17.38
621	62.1	69.0	16.27	17.41
622	62.2	69.2	16.31	17.44
623	62.3	69.3	16.34	17.47
624	62.4	69.5	16.38	17.50
625	62.5	69.5	16.42	17.53
626	62.6	69.7	16.45	17.56
627	62.7	69.8	16.49	17.59
628	62.8	70.0	16.52	17.62
629	62.9	70.0	16.56	17.66



【PUHY-P840SM-E】

室内ユニット 合計容量	能力 (kW)		入力 (kW)	
	冷房	暖房	冷房	暖房
630	63.0	70.0	16.59	17.69
631	63.1	70.2	16.63	17.72
632	63.2	70.3	16.67	17.75
633	63.3	70.5	16.70	17.78
634	63.4	70.5	16.74	17.81
635	63.5	70.7	16.77	17.84
636	63.6	70.8	16.81	17.87
637	63.7	71.0	16.84	17.90
638	63.8	71.0	16.88	17.94
639	63.9	71.0	16.92	17.97
640	64.0	71.2	16.95	18.00
641	64.1	71.3	16.99	18.03
642	64.2	71.5	17.02	18.06
643	64.3	71.5	17.06	18.09
644	64.4	71.7	17.10	18.12
645	64.5	71.8	17.13	18.16
646	64.6	72.0	17.17	18.19
647	64.7	72.0	17.21	18.22
648	64.8	72.0	17.24	18.25
649	64.9	72.2	17.28	18.28
650	65.0	72.3	17.32	18.31
651	65.1	72.5	17.35	18.35
652	65.2	72.5	17.39	18.38
653	65.3	72.7	17.42	18.41
654	65.4	72.8	17.46	18.44
655	65.5	73.0	17.50	18.47
656	65.6	73.0	17.53	18.51
657	65.7	73.0	17.57	18.54
658	65.8	73.2	17.61	18.57
659	65.9	73.3	17.64	18.60
660	66.0	73.5	17.68	18.64
661	66.1	73.5	17.72	18.67
662	66.2	73.7	17.75	18.70
663	66.3	73.8	17.79	18.73
664	66.4	74.0	17.83	18.77
665	66.5	74.0	17.87	18.80
666	66.6	74.0	17.90	18.83
667	66.7	74.2	17.94	18.86
668	66.8	74.3	17.98	18.90
669	66.9	74.5	18.01	18.93
670	67.0	74.5	18.05	18.96
671	67.1	74.7	18.09	18.99
672	67.2	74.8	18.12	19.03
673	67.3	75.0	18.16	19.06
674	67.4	75.0	18.20	19.09
675	67.5	75.0	18.24	19.13
676	67.6	75.2	18.27	19.16
677	67.7	75.3	18.31	19.19
678	67.8	75.5	18.35	19.23
679	67.9	75.5	18.39	19.26
680	68.0	75.7	18.42	19.29
681	68.1	75.8	18.46	19.33
682	68.2	76.0	18.50	19.36
683	68.3	76.0	18.54	19.39
684	68.4	76.0	18.57	19.43
685	68.5	76.2	18.61	19.46
686	68.6	76.3	18.65	19.49
687	68.7	76.5	18.69	19.53
688	68.8	76.5	18.72	19.56
689	68.9	76.7	18.76	19.59
690	69.0	76.8	18.80	19.63
691	69.1	77.0	18.84	19.66
692	69.2	77.0	18.88	19.70
693	69.3	77.0	18.91	19.73
694	69.4	77.2	18.95	19.76
695	69.5	77.3	18.99	19.80
696	69.6	77.5	19.03	19.83
697	69.7	77.5	19.07	19.87
698	69.8	77.7	19.10	19.90
699	69.9	77.8	19.14	19.93

室内ユニット 合計容量	能力 (kW)		入力 (kW)	
	冷房	暖房	冷房	暖房
700	70.0	78.0	19.18	19.97
701	70.1	78.0	19.22	20.00
702	70.2	78.0	19.26	20.04
703	70.3	78.2	19.29	20.07
704	70.4	78.3	19.33	20.11
705	70.5	78.5	19.37	20.14
706	70.6	78.5	19.41	20.18
707	70.7	78.7	19.45	20.21
708	70.8	78.8	19.49	20.25
709	70.9	79.0	19.53	20.28
710	71.0	79.0	19.56	20.32
711	71.1	79.0	19.60	20.35
712	71.2	79.2	19.64	20.39
713	71.3	79.3	19.68	20.42
714	71.4	79.5	19.72	20.46
715	71.5	79.5	19.76	20.49
716	71.6	79.7	19.80	20.53
717	71.7	79.8	19.83	20.56
718	71.8	80.0	19.87	20.60
719	71.9	80.0	19.91	20.63
720	72.0	80.0	19.95	20.67
721	72.1	80.2	19.99	20.70
722	72.2	80.3	20.03	20.74
723	72.3	80.5	20.07	20.77
724	72.4	80.5	20.11	20.81
725	72.5	80.7	20.15	20.84
726	72.6	80.8	20.18	20.88
727	72.7	81.0	20.22	20.92
728	72.8	81.0	20.26	20.95
729	72.9	81.0	20.30	20.99
730	73.0	81.2	20.34	21.02
731	73.1	81.3	20.38	21.06
732	73.2	81.5	20.42	21.10
733	73.3	81.5	20.46	21.13
734	73.4	81.7	20.50	21.17
735	73.5	81.8	20.54	21.21
736	73.6	82.0	20.58	21.24
737	73.7	82.0	20.62	21.28
738	73.8	82.0	20.66	21.31
739	73.9	82.2	20.70	21.35
740	74.0	82.3	20.74	21.39
741	74.1	82.5	20.78	21.42
742	74.2	82.5	20.82	21.46
743	74.3	82.7	20.86	21.50
744	74.4	82.8	20.89	21.53
745	74.5	83.0	20.93	21.57
746	74.6	83.0	20.97	21.61
747	74.7	83.0	21.01	21.64
748	74.8	83.2	21.05	21.68
749	74.9	83.3	21.09	21.72
750	75.0	83.5	21.13	21.76
751	75.1	83.5	21.17	21.79
752	75.2	83.7	21.21	21.83
753	75.3	83.8	21.25	21.87
754	75.4	84.0	21.29	21.91
755	75.5	84.0	21.33	21.94
756	75.6	84.0	21.37	21.98
757	75.7	84.2	21.41	22.02
758	75.8	84.3	21.45	22.06
759	75.9	84.5	21.50	22.09
760	76.0	84.5	21.54	22.13
761	76.1	84.7	21.58	22.17
762	76.2	84.8	21.62	22.21
763	76.3	85.0	21.66	22.25
764	76.4	85.0	21.70	22.28
765	76.5	85.0	21.74	22.32
766	76.6	85.2	21.78	22.36
767	76.7	85.3	21.82	22.40
768	76.8	85.5	21.86	22.44
769	76.9	85.5	21.90	22.47

室内ユニット 合計容量	能力 (kW)		入力 (kW)	
	冷房	暖房	冷房	暖房
770	77.0	85.7	21.94	22.51
771	77.1	85.8	21.98	22.55
772	77.2	86.0	22.02	22.59
773	77.3	86.0	22.06	22.63
774	77.4	86.0	22.10	22.67
775	77.5	86.2	22.14	22.71
776	77.6	86.3	22.19	22.74
777	77.7	86.5	22.23	22.78
778	77.8	86.5	22.27	22.82
779	77.9	86.7	22.31	22.86
780	78.0	86.8	22.35	22.90
781	78.1	87.0	22.39	22.94
782	78.2	87.0	22.43	22.98
783	78.3	87.0	22.47	23.02
784	78.4	87.2	22.51	23.06
785	78.5	87.3	22.55	23.10
786	78.6	87.5	22.60	23.14
787	78.7	87.5	22.64	23.18
788	78.8	87.7	22.68	23.22
789	78.9	87.8	22.72	23.25
790	79.0	88.0	22.76	23.29
791	79.1	88.0	22.80	23.33
792	79.2	88.0	22.84	23.37
793	79.3	88.2	22.89	23.41
794	79.4	88.3	22.93	23.45
795	79.5	88.5	22.97	23.49
796	79.6	88.5	23.01	23.53
797	79.7	88.7	23.05	23.57
798	79.8	88.8	23.09	23.61
799	79.9	89.0	23.14	23.66
800	80.0	89.0	23.18	23.70
801	80.1	89.0	23.22	23.74
802	80.2	89.2	23.26	23.78
803	80.3	89.3	23.30	23.82
804	80.4	89.5	23.34	23.86
805	80.5	89.5	23.39	23.90
806	80.6	89.7	23.43	23.94
807	80.7	89.8	23.47	23.98
808	80.8	90.0	23.51	24.02
809	80.9	90.0	23.55	24.06
810	81.0	90.0	23.60	24.10
811	81.1	90.2	23.64	24.14
812	81.2	90.3	23.68	24.19
813	81.3	90.5	23.72	24.23
814	81.4	90.5	23.76	24.27
815	81.5	90.7	23.81	24.31
816	81.6	90.8	23.85	24.35
817	81.7	91.0	23.89	24.39
818	81.8	91.0	23.93	24.43
819	81.9	91.0	23.98	24.48
820	82.0	91.2	24.02	24.52
821	82.1	91.3	24.06	24.56
822	82.2	91.5	24.10	24.60
823	82.3	91.5	24.15	24.64
824	82.4	91.7	24.19	24.69
825	82.5	91.8	24.23	24.73
826	82.6	92.0	24.27	24.77
827	82.7	92.0	24.32	24.81
828	82.8	92.0	24.36	24.85
829	82.9	92.2	24.40	24.90
830	83.0	92.3	24.45	24.94
831	83.1	92.5	24.49	24.98
832	83.2	92.5	24.53	25.03
833	83.3	92.7	24.57	25.07
834	83.4	92.8	24.62	25.11
835	83.5	93.0	24.66	25.15
836	83.6	93.0	24.70	25.20
837	83.7	93.0	24.75	25.24
838	83.8	93.2	24.79	25.28
839	83.9	93.3	24.83	25.33

【PUHY-P840SM-E】

室内ユニット 合計容量	能力 (kW)		入力 (kW)	
	冷房	暖房	冷房	暖房
840	84.0	94.5	24.90	25.37
841	84.0	94.5	24.90	25.36
842	84.1	94.5	24.90	25.36
843	84.1	94.5	24.90	25.35
844	84.1	94.5	24.90	25.34
845	84.1	94.5	24.90	25.33
846	84.2	94.5	24.90	25.33
847	84.2	94.5	24.90	25.32
848	84.2	94.5	24.90	25.31
849	84.2	94.5	24.90	25.31
850	84.3	94.5	24.90	25.30
851	84.3	94.5	24.90	25.29
852	84.3	94.5	24.90	25.29
853	84.3	94.5	24.90	25.28
854	84.4	94.5	24.90	25.27
855	84.4	94.5	24.90	25.26
856	84.4	94.5	24.90	25.26
857	84.5	94.5	24.91	25.25
858	84.5	94.5	24.91	25.24
859	84.5	94.5	24.91	25.24
860	84.5	94.5	24.91	25.23
861	84.6	94.5	24.91	25.22
862	84.6	94.5	24.91	25.22
863	84.6	94.5	24.91	25.21
864	84.6	94.5	24.91	25.20
865	84.7	94.5	24.91	25.19
866	84.7	94.5	24.91	25.19
867	84.7	94.5	24.91	25.18
868	84.8	94.5	24.91	25.17
869	84.8	94.5	24.91	25.17
870	84.8	94.5	24.91	25.16
871	84.8	94.5	24.91	25.15
872	84.9	94.5	24.91	25.15
873	84.9	94.5	24.91	25.14
874	84.9	94.5	24.92	25.13
875	84.9	94.5	24.92	25.12
876	85.0	94.5	24.92	25.12
877	85.0	94.5	24.92	25.11
878	85.0	94.5	24.92	25.10
879	85.0	94.5	24.92	25.10
880	85.1	94.5	24.92	25.09
881	85.1	94.5	24.92	25.08
882	85.1	94.6	24.92	25.07
883	85.2	94.6	24.92	25.07
884	85.2	94.6	24.92	25.06
885	85.2	94.6	24.92	25.05
886	85.2	94.6	24.92	25.05
887	85.3	94.6	24.92	25.04
888	85.3	94.6	24.92	25.03
889	85.3	94.6	24.92	25.03
890	85.3	94.6	24.92	25.02
891	85.4	94.6	24.92	25.01
892	85.4	94.6	24.93	25.00
893	85.4	94.6	24.93	25.00
894	85.4	94.6	24.93	24.99
895	85.5	94.6	24.93	24.98
896	85.5	94.6	24.93	24.98
897	85.5	94.6	24.93	24.97
898	85.6	94.6	24.93	24.96
899	85.6	94.6	24.93	24.96
900	85.6	94.6	24.93	24.95
901	85.6	94.6	24.93	24.94
902	85.7	94.6	24.93	24.93
903	85.7	94.6	24.93	24.93
904	85.7	94.6	24.93	24.92
905	85.7	94.6	24.93	24.91
906	85.8	94.6	24.93	24.91
907	85.8	94.6	24.93	24.90
908	85.8	94.6	24.93	24.89
909	85.8	94.6	24.93	24.89

室内ユニット 合計容量	能力 (kW)		入力 (kW)	
	冷房	暖房	冷房	暖房
910	85.9	94.6	24.94	24.88
911	85.9	94.6	24.94	24.87
912	85.9	94.6	24.94	24.86
913	86.0	94.6	24.94	24.86
914	86.0	94.6	24.94	24.85
915	86.0	94.6	24.94	24.84
916	86.0	94.6	24.94	24.84
917	86.1	94.6	24.94	24.83
918	86.1	94.6	24.94	24.82
919	86.1	94.6	24.94	24.81
920	86.1	94.6	24.94	24.81
921	86.2	94.6	24.94	24.80
922	86.2	94.6	24.94	24.79
923	86.2	94.6	24.94	24.79
924	86.3	94.6	24.94	24.78
925	86.3	94.6	24.94	24.77
926	86.3	94.6	24.94	24.77
927	86.3	94.6	24.95	24.76
928	86.4	94.6	24.95	24.75
929	86.4	94.6	24.95	24.74
930	86.4	94.6	24.95	24.74
931	86.4	94.6	24.95	24.73
932	86.5	94.6	24.95	24.72
933	86.5	94.6	24.95	24.72
934	86.5	94.6	24.95	24.71
935	86.5	94.6	24.95	24.70
936	86.6	94.6	24.95	24.70
937	86.6	94.6	24.95	24.69
938	86.6	94.6	24.95	24.68
939	86.7	94.6	24.95	24.67
940	86.7	94.6	24.95	24.67
941	86.7	94.6	24.95	24.66
942	86.7	94.6	24.95	24.65
943	86.8	94.6	24.95	24.65
944	86.8	94.6	24.95	24.64
945	86.8	94.6	24.96	24.63
946	86.8	94.6	24.96	24.63
947	86.9	94.6	24.96	24.62
948	86.9	94.6	24.96	24.61
949	86.9	94.6	24.96	24.60
950	86.9	94.6	24.96	24.60
951	87.0	94.6	24.96	24.59
952	87.0	94.6	24.96	24.58
953	87.0	94.6	24.96	24.58
954	87.1	94.6	24.96	24.57
955	87.1	94.6	24.96	24.56
956	87.1	94.6	24.96	24.56
957	87.1	94.6	24.96	24.55
958	87.2	94.6	24.96	24.54
959	87.2	94.6	24.96	24.53
960	87.2	94.6	24.96	24.53
961	87.2	94.6	24.96	24.52
962	87.3	94.6	24.96	24.51
963	87.3	94.6	24.97	24.51
964	87.3	94.6	24.97	24.50
965	87.4	94.7	24.97	24.49
966	87.4	94.7	24.97	24.48
967	87.4	94.7	24.97	24.48
968	87.4	94.7	24.97	24.47
969	87.5	94.7	24.97	24.46
970	87.5	94.7	24.97	24.46
971	87.5	94.7	24.97	24.45
972	87.5	94.7	24.97	24.44
973	87.6	94.7	24.97	24.44
974	87.6	94.7	24.97	24.43
975	87.6	94.7	24.97	24.42
976	87.6	94.7	24.97	24.41
977	87.7	94.7	24.97	24.41
978	87.7	94.7	24.97	24.40
979	87.7	94.7	24.97	24.39

室内ユニット 合計容量	能力 (kW)		入力 (kW)	
	冷房	暖房	冷房	暖房
980	87.8	94.7	24.98	24.39
981	87.8	94.7	24.98	24.38
982	87.8	94.7	24.98	24.37
983	87.8	94.7	24.98	24.37
984	87.9	94.7	24.98	24.36
985	87.9	94.7	24.98	24.35
986	87.9	94.7	24.98	24.34
987	87.9	94.7	24.98	24.34
988	88.0	94.7	24.98	24.33
989	88.0	94.7	24.98	24.32
990	88.0	94.7	24.98	24.32
991	88.0	94.7	24.98	24.31
992	88.1	94.7	24.98	24.30
993	88.1	94.7	24.98	24.30
994	88.1	94.7	24.98	24.29
995	88.2	94.7	24.98	24.28
996	88.2	94.7	24.98	24.27
997	88.2	94.7	24.98	24.27
998	88.2	94.7	24.99	24.26
999	88.3	94.7	24.99	24.25
1000	88.3	94.7	24.99	24.25
1001	88.3	94.7	24.99	24.24
1002	88.3	94.7	24.99	24.23
1003	88.4	94.7	24.99	24.22
1004	88.4	94.7	24.99	24.22
1005	88.4	94.7	24.99	24.21
1006	88.4	94.7	24.99	24.20
1007	88.5	94.7	24.99	24.20
1008	88.5	94.7	24.99	24.19
1009	88.5	94.7	24.99	24.18
1010	88.6	94.7	24.99	24.18
1011	88.6	94.7	24.99	24.17
1012	88.6	94.7	24.99	24.16
1013	88.6	94.7	24.99	24.15
1014	88.7	94.7	24.99	24.15
1015	88.7	94.7	24.99	24.14
1016	88.7	94.7	25.00	24.13
1017	88.7	94.7	25.00	24.13
1018	88.8	94.7	25.00	24.12
1019	88.8	94.7	25.00	24.11
1020	88.8	94.7	25.00	24.11
1021	88.9	94.7	25.00	24.10
1022	88.9	94.7	25.00	24.09
1023	88.9	94.7	25.00	24.08
1024	88.9	94.7	25.00	24.08
1025	89.0	94.7	25.00	24.07
1026	89.0	94.7	25.00	24.06
1027	89.0	94.7	25.00	24.06
1028	89.0	94.7	25.00	24.05
1029	89.1	94.7	25.00	24.04
1030	89.1	94.7	25.00	24.04
1031	89.1	94.7	25.00	24.03
1032	89.1	94.7	25.00	24.02
1033	89.2	94.7	25.01	24.01
1034	89.2	94.7	25.01	24.01
1035	89.2	94.7	25.01	24.00
1036	89.3	94.7	25.01	23.99
1037	89.3	94.7	25.01	23.99
1038	89.3	94.7	25.01	23.98
1039	89.3	94.7	25.01	23.97
1040	89.4	94.7	25.01	23.97
1041	89.4	94.7	25.01	23.96
1042	89.4	94.7	25.01	23.95
1043	89.4	94.7	25.01	23.94
1044	89.5	94.7	25.01	23.94
1045	89.5	94.7	25.01	23.93
1046	89.5	94.7	25.01	23.92
1047	89.5	94.7	25.01	23.92
1048	89.6	94.7	25.01	23.91
1049	89.6	94.8	25.01	23.90

## 【PUHY-P840SM-E】

室内ユニット 合計容量	能力 (kW)		入力 (kW)	
	冷房	暖房	冷房	暖房
1050	89.6	94.8	25.01	23.89
1051	89.7	94.8	25.02	23.89
1052	89.7	94.8	25.02	23.88
1053	89.7	94.8	25.02	23.87
1054	89.7	94.8	25.02	23.87
1055	89.8	94.8	25.02	23.86
1056	89.8	94.8	25.02	23.85
1057	89.8	94.8	25.02	23.85
1058	89.8	94.8	25.02	23.84
1059	89.9	94.8	25.02	23.83
1060	89.9	94.8	25.02	23.82
1061	89.9	94.8	25.02	23.82
1062	89.9	94.8	25.02	23.81
1063	90.0	94.8	25.02	23.80
1064	90.0	94.8	25.02	23.80
1065	90.0	94.8	25.02	23.79
1066	90.1	94.8	25.02	23.78
1067	90.1	94.8	25.02	23.78
1068	90.1	94.8	25.02	23.77
1069	90.1	94.8	25.03	23.76
1070	90.2	94.8	25.03	23.75
1071	90.2	94.8	25.03	23.75
1072	90.2	94.8	25.03	23.74
1073	90.2	94.8	25.03	23.73
1074	90.3	94.8	25.03	23.73
1075	90.3	94.8	25.03	23.72
1076	90.3	94.8	25.03	23.71
1077	90.4	94.8	25.03	23.71
1078	90.4	94.8	25.03	23.70
1079	90.4	94.8	25.03	23.69
1080	90.4	94.8	25.03	23.68
1081	90.5	94.8	25.03	23.68
1082	90.5	94.8	25.03	23.67
1083	90.5	94.8	25.03	23.66
1084	90.5	94.8	25.03	23.66
1085	90.6	94.8	25.03	23.65
1086	90.6	94.8	25.04	23.64
1087	90.6	94.8	25.04	23.63
1088	90.6	94.8	25.04	23.63
1089	90.7	94.8	25.04	23.62
1090	90.7	94.8	25.04	23.61
1091	90.7	94.8	25.04	23.61
1092	90.8	94.8	25.04	23.60

【PUHY-P900SM-E】

室内ユニット 合計容量	能力 (kW)		入力 (kW)	
	冷房	暖房	冷房	暖房
450	45.0	50.0	10.96	12.88
451	45.1	50.1	10.99	12.91
452	45.2	50.2	11.02	12.93
453	45.3	50.3	11.05	12.96
454	45.4	50.4	11.08	12.99
455	45.5	50.6	11.11	13.01
456	45.6	50.7	11.14	13.04
457	45.7	50.8	11.17	13.07
458	45.8	50.9	11.20	13.10
459	45.9	51.0	11.23	13.12
460	46.0	51.1	11.26	13.15
461	46.1	51.2	11.28	13.18
462	46.2	51.3	11.31	13.20
463	46.3	51.4	11.34	13.23
464	46.4	51.6	11.37	13.26
465	46.5	51.7	11.40	13.29
466	46.6	51.8	11.43	13.31
467	46.7	51.9	11.46	13.34
468	46.8	52.0	11.49	13.37
469	46.9	52.1	11.52	13.40
470	47.0	52.2	11.55	13.42
471	47.1	52.3	11.58	13.45
472	47.2	52.4	11.61	13.48
473	47.3	52.6	11.64	13.50
474	47.4	52.7	11.67	13.53
475	47.5	52.8	11.70	13.56
476	47.6	52.9	11.73	13.59
477	47.7	53.0	11.76	13.61
478	47.8	53.1	11.79	13.64
479	47.9	53.2	11.82	13.67
480	48.0	53.3	11.85	13.70
481	48.1	53.4	11.88	13.72
482	48.2	53.6	11.91	13.75
483	48.3	53.7	11.94	13.78
484	48.4	53.8	11.97	13.81
485	48.5	53.9	12.00	13.83
486	48.6	54.0	12.03	13.86
487	48.7	54.1	12.06	13.89
488	48.8	54.2	12.09	13.92
489	48.9	54.3	12.12	13.94
490	49.0	54.4	12.15	13.97
491	49.1	54.6	12.18	14.00
492	49.2	54.7	12.21	14.03
493	49.3	54.8	12.24	14.05
494	49.4	54.9	12.27	14.08
495	49.5	55.0	12.30	14.11
496	49.6	55.1	12.33	14.14
497	49.7	55.2	12.36	14.16
498	49.8	55.3	12.39	14.19
499	49.9	55.4	12.42	14.22
500	50.0	55.6	12.45	14.25
501	50.1	55.7	12.48	14.28
502	50.2	55.8	12.51	14.30
503	50.3	55.9	12.54	14.33
504	50.4	56.0	12.57	14.36
505	50.5	56.1	12.60	14.39
506	50.6	56.2	12.63	14.41
507	50.7	56.3	12.66	14.44
508	50.8	56.4	12.69	14.47
509	50.9	56.6	12.72	14.50
510	51.0	56.7	12.75	14.53
511	51.1	56.8	12.78	14.55
512	51.2	56.9	12.81	14.58
513	51.3	57.0	12.85	14.61
514	51.4	57.1	12.88	14.64
515	51.5	57.2	12.91	14.67
516	51.6	57.3	12.94	14.69
517	51.7	57.4	12.97	14.72
518	51.8	57.6	13.00	14.75
519	51.9	57.7	13.03	14.78

室内ユニット 合計容量	能力 (kW)		入力 (kW)	
	冷房	暖房	冷房	暖房
520	52.0	57.8	13.06	14.81
521	52.1	57.9	13.09	14.83
522	52.2	58.0	13.12	14.86
523	52.3	58.1	13.15	14.89
524	52.4	58.2	13.19	14.92
525	52.5	58.3	13.22	14.95
526	52.6	58.4	13.25	14.97
527	52.7	58.6	13.28	15.00
528	52.8	58.7	13.31	15.03
529	52.9	58.8	13.34	15.06
530	53.0	58.9	13.37	15.09
531	53.1	59.0	13.40	15.11
532	53.2	59.1	13.43	15.14
533	53.3	59.2	13.47	15.17
534	53.4	59.3	13.50	15.20
535	53.5	59.4	13.53	15.23
536	53.6	59.6	13.56	15.26
537	53.7	59.7	13.59	15.28
538	53.8	59.8	13.62	15.31
539	53.9	59.9	13.65	15.34
540	54.0	60.0	13.68	15.37
541	54.1	60.1	13.72	15.40
542	54.2	60.2	13.75	15.42
543	54.3	60.3	13.78	15.45
544	54.4	60.4	13.81	15.48
545	54.5	60.6	13.84	15.51
546	54.6	60.7	13.87	15.54
547	54.7	60.8	13.91	15.57
548	54.8	60.9	13.94	15.60
549	54.9	61.0	13.97	15.62
550	55.0	61.1	14.00	15.65
551	55.1	61.2	14.03	15.68
552	55.2	61.3	14.06	15.71
553	55.3	61.4	14.10	15.74
554	55.4	61.6	14.13	15.77
555	55.5	61.7	14.16	15.79
556	55.6	61.8	14.19	15.82
557	55.7	61.9	14.22	15.85
558	55.8	62.0	14.26	15.88
559	55.9	62.1	14.29	15.91
560	56.0	62.2	14.32	15.94
561	56.1	62.3	14.35	15.97
562	56.2	62.4	14.38	15.99
563	56.3	62.6	14.42	16.02
564	56.4	62.7	14.45	16.05
565	56.5	62.8	14.48	16.08
566	56.6	62.9	14.51	16.11
567	56.7	63.0	14.54	16.14
568	56.8	63.1	14.58	16.17
569	56.9	63.2	14.61	16.20
570	57.0	63.3	14.64	16.22
571	57.1	63.4	14.67	16.25
572	57.2	63.6	14.70	16.28
573	57.3	63.7	14.74	16.31
574	57.4	63.8	14.77	16.34
575	57.5	63.9	14.80	16.37
576	57.6	64.0	14.83	16.40
577	57.7	64.1	14.87	16.43
578	57.8	64.2	14.90	16.46
579	57.9	64.3	14.93	16.48
580	58.0	64.4	14.96	16.51
581	58.1	64.6	15.00	16.54
582	58.2	64.7	15.03	16.57
583	58.3	64.8	15.06	16.60
584	58.4	64.9	15.09	16.63
585	58.5	65.0	15.13	16.66
586	58.6	65.1	15.16	16.69
587	58.7	65.2	15.19	16.72
588	58.8	65.3	15.22	16.75
589	58.9	65.4	15.26	16.78

室内ユニット 合計容量	能力 (kW)		入力 (kW)	
	冷房	暖房	冷房	暖房
590	59.0	65.6	15.29	16.80
591	59.1	65.7	15.32	16.83
592	59.2	65.8	15.36	16.86
593	59.3	65.9	15.39	16.89
594	59.4	66.0	15.42	16.92
595	59.5	66.1	15.45	16.95
596	59.6	66.2	15.49	16.98
597	59.7	66.3	15.52	17.01
598	59.8	66.4	15.55	17.04
599	59.9	66.6	15.59	17.07
600	60.0	66.7	15.62	17.10
601	60.1	66.8	15.65	17.13
602	60.2	66.9	15.69	17.16
603	60.3	67.0	15.72	17.18
604	60.4	67.1	15.75	17.21
605	60.5	67.2	15.79	17.24
606	60.6	67.3	15.82	17.27
607	60.7	67.4	15.85	17.30
608	60.8	67.6	15.88	17.33
609	60.9	67.7	15.92	17.36
610	61.0	67.8	15.95	17.39
611	61.1	67.9	15.98	17.42
612	61.2	68.0	16.02	17.45
613	61.3	68.1	16.05	17.48
614	61.4	68.2	16.08	17.51
615	61.5	68.3	16.12	17.54
616	61.6	68.4	16.15	17.57
617	61.7	68.6	16.19	17.60
618	61.8	68.7	16.22	17.63
619	61.9	68.8	16.25	17.66
620	62.0	68.9	16.29	17.69
621	62.1	69.0	16.32	17.72
622	62.2	69.1	16.35	17.75
623	62.3	69.2	16.39	17.78
624	62.4	69.3	16.42	17.81
625	62.5	69.4	16.45	17.84
626	62.6	69.6	16.49	17.87
627	62.7	69.7	16.52	17.90
628	62.8	69.8	16.56	17.92
629	62.9	69.9	16.59	17.95
630	63.0	70.0	16.62	17.98
631	63.1	70.1	16.66	18.01
632	63.2	70.2	16.69	18.04
633	63.3	70.3	16.72	18.07
634	63.4	70.4	16.76	18.10
635	63.5	70.6	16.79	18.13
636	63.6	70.7	16.83	18.16
637	63.7	70.8	16.86	18.19
638	63.8	70.9	16.89	18.22
639	63.9	71.0	16.93	18.25
640	64.0	71.1	16.96	18.28
641	64.1	71.2	17.00	18.31
642	64.2	71.3	17.03	18.34
643	64.3	71.4	17.07	18.37
644	64.4	71.6	17.10	18.40
645	64.5	71.7	17.13	18.44
646	64.6	71.8	17.17	18.47
647	64.7	71.9	17.20	18.50
648	64.8	72.0	17.24	18.53
649	64.9	72.1	17.27	18.56
650	65.0	72.2	17.31	18.59
651	65.1	72.3	17.34	18.62
652	65.2	72.4	17.37	18.65
653	65.3	72.6	17.41	18.68
654	65.4	72.7	17.44	18.71
655	65.5	72.8	17.48	18.74
656	65.6	72.9	17.51	18.77
657	65.7	73.0	17.55	18.80
658	65.8	73.1	17.58	18.83
659	65.9	73.2	17.62	18.86

## 【PUHY-P900SM-E】

室内ユニット 合計容量	能力 (kW)		入力 (kW)	
	冷房	暖房	冷房	暖房
660	66.0	73.3	17.65	18.89
661	66.1	73.4	17.69	18.92
662	66.2	73.6	17.72	18.95
663	66.3	73.7	17.75	18.98
664	66.4	73.8	17.79	19.01
665	66.5	73.9	17.82	19.04
666	66.6	74.0	17.86	19.07
667	66.7	74.1	17.89	19.10
668	66.8	74.2	17.93	19.13
669	66.9	74.3	17.96	19.17
670	67.0	74.4	18.00	19.20
671	67.1	74.6	18.03	19.23
672	67.2	74.7	18.07	19.26
673	67.3	74.8	18.10	19.29
674	67.4	74.9	18.14	19.32
675	67.5	75.0	18.17	19.35
676	67.6	75.1	18.21	19.38
677	67.7	75.2	18.24	19.41
678	67.8	75.3	18.28	19.44
679	67.9	75.4	18.31	19.47
680	68.0	75.6	18.35	19.50
681	68.1	75.7	18.38	19.53
682	68.2	75.8	18.42	19.57
683	68.3	75.9	18.46	19.60
684	68.4	76.0	18.49	19.63
685	68.5	76.1	18.53	19.66
686	68.6	76.2	18.56	19.69
687	68.7	76.3	18.60	19.72
688	68.8	76.4	18.63	19.75
689	68.9	76.6	18.67	19.78
690	69.0	76.7	18.70	19.81
691	69.1	76.8	18.74	19.85
692	69.2	76.9	18.77	19.88
693	69.3	77.0	18.81	19.91
694	69.4	77.1	18.84	19.94
695	69.5	77.2	18.88	19.97
696	69.6	77.3	18.92	20.00
697	69.7	77.4	18.95	20.03
698	69.8	77.6	18.99	20.06
699	69.9	77.7	19.02	20.10
700	70.0	77.8	19.06	20.13
701	70.1	77.9	19.09	20.16
702	70.2	78.0	19.13	20.19
703	70.3	78.1	19.17	20.22
704	70.4	78.2	19.20	20.25
705	70.5	78.3	19.24	20.28
706	70.6	78.4	19.27	20.32
707	70.7	78.6	19.31	20.35
708	70.8	78.7	19.35	20.38
709	70.9	78.8	19.38	20.41
710	71.0	78.9	19.42	20.44
711	71.1	79.0	19.45	20.47
712	71.2	79.1	19.49	20.50
713	71.3	79.2	19.53	20.54
714	71.4	79.3	19.56	20.57
715	71.5	79.4	19.60	20.60
716	71.6	79.6	19.63	20.63
717	71.7	79.7	19.67	20.66
718	71.8	79.8	19.71	20.69
719	71.9	79.9	19.74	20.73
720	72.0	80.0	19.78	20.76
721	72.1	80.1	19.81	20.79
722	72.2	80.2	19.85	20.82
723	72.3	80.3	19.89	20.85
724	72.4	80.4	19.92	20.89
725	72.5	80.6	19.96	20.92
726	72.6	80.7	20.00	20.95
727	72.7	80.8	20.03	20.98
728	72.8	80.9	20.07	21.01
729	72.9	81.0	20.11	21.05

室内ユニット 合計容量	能力 (kW)		入力 (kW)	
	冷房	暖房	冷房	暖房
730	73.0	81.1	20.14	21.08
731	73.1	81.2	20.18	21.11
732	73.2	81.3	20.22	21.14
733	73.3	81.4	20.25	21.17
734	73.4	81.6	20.29	21.21
735	73.5	81.7	20.33	21.24
736	73.6	81.8	20.36	21.27
737	73.7	81.9	20.40	21.30
738	73.8	82.0	20.44	21.33
739	73.9	82.1	20.47	21.37
740	74.0	82.2	20.51	21.40
741	74.1	82.3	20.55	21.43
742	74.2	82.4	20.58	21.46
743	74.3	82.6	20.62	21.50
744	74.4	82.7	20.66	21.53
745	74.5	82.8	20.69	21.56
746	74.6	82.9	20.73	21.59
747	74.7	83.0	20.77	21.63
748	74.8	83.1	20.80	21.66
749	74.9	83.2	20.84	21.69
750	75.0	83.3	20.88	21.72
751	75.1	83.4	20.92	21.76
752	75.2	83.6	20.95	21.79
753	75.3	83.7	20.99	21.82
754	75.4	83.8	21.03	21.85
755	75.5	83.9	21.06	21.89
756	75.6	84.0	21.10	21.92
757	75.7	84.1	21.14	21.95
758	75.8	84.2	21.18	21.98
759	75.9	84.3	21.21	22.02
760	76.0	84.4	21.25	22.05
761	76.1	84.6	21.29	22.08
762	76.2	84.7	21.33	22.11
763	76.3	84.8	21.36	22.15
764	76.4	84.9	21.40	22.18
765	76.5	85.0	21.44	22.21
766	76.6	85.1	21.48	22.25
767	76.7	85.2	21.51	22.28
768	76.8	85.3	21.55	22.31
769	76.9	85.4	21.59	22.34
770	77.0	85.6	21.63	22.38
771	77.1	85.7	21.66	22.41
772	77.2	85.8	21.70	22.44
773	77.3	85.9	21.74	22.48
774	77.4	86.0	21.78	22.51
775	77.5	86.1	21.81	22.54
776	77.6	86.2	21.85	22.58
777	77.7	86.3	21.89	22.61
778	77.8	86.4	21.93	22.64
779	77.9	86.6	21.96	22.68
780	78.0	86.7	22.00	22.71
781	78.1	86.8	22.04	22.74
782	78.2	86.9	22.08	22.78
783	78.3	87.0	22.12	22.81
784	78.4	87.1	22.15	22.84
785	78.5	87.2	22.19	22.88
786	78.6	87.3	22.23	22.91
787	78.7	87.4	22.27	22.94
788	78.8	87.6	22.31	22.98
789	78.9	87.7	22.34	23.01
790	79.0	87.8	22.38	23.04
791	79.1	87.9	22.42	23.08
792	79.2	88.0	22.46	23.11
793	79.3	88.1	22.50	23.14
794	79.4	88.2	22.54	23.18
795	79.5	88.3	22.57	23.21
796	79.6	88.4	22.61	23.24
797	79.7	88.6	22.65	23.28
798	79.8	88.7	22.69	23.31
799	79.9	88.8	22.73	23.35

室内ユニット 合計容量	能力 (kW)		入力 (kW)	
	冷房	暖房	冷房	暖房
800	80.0	88.9	22.77	23.38
801	80.1	89.0	22.80	23.41
802	80.2	89.1	22.84	23.45
803	80.3	89.2	22.88	23.48
804	80.4	89.3	22.92	23.52
805	80.5	89.4	22.96	23.55
806	80.6	89.6	23.00	23.58
807	80.7	89.7	23.04	23.62
808	80.8	89.8	23.07	23.65
809	80.9	89.9	23.11	23.68
810	81.0	90.0	23.15	23.72
811	81.1	90.1	23.19	23.75
812	81.2	90.2	23.23	23.79
813	81.3	90.3	23.27	23.82
814	81.4	90.4	23.31	23.86
815	81.5	90.6	23.34	23.89
816	81.6	90.7	23.38	23.92
817	81.7	90.8	23.42	23.96
818	81.8	90.9	23.46	23.99
819	81.9	91.0	23.50	24.03
820	82.0	91.1	23.54	24.06
821	82.1	91.2	23.58	24.10
822	82.2	91.3	23.62	24.13
823	82.3	91.4	23.66	24.16
824	82.4	91.6	23.70	24.20
825	82.5	91.7	23.73	24.23
826	82.6	91.8	23.77	24.27
827	82.7	91.9	23.81	24.30
828	82.8	92.0	23.85	24.34
829	82.9	92.1	23.89	24.37
830	83.0	92.2	23.93	24.41
831	83.1	92.3	23.97	24.44
832	83.2	92.4	24.01	24.47
833	83.3	92.6	24.05	24.51
834	83.4	92.7	24.09	24.54
835	83.5	92.8	24.13	24.58
836	83.6	92.9	24.17	24.61
837	83.7	93.0	24.21	24.65
838	83.8	93.1	24.24	24.68
839	83.9	93.2	24.28	24.72
840	84.0	93.3	24.32	24.75
841	84.1	93.4	24.36	24.79
842	84.2	93.6	24.40	24.82
843	84.3	93.7	24.44	24.86
844	84.4	93.8	24.48	24.89
845	84.5	93.9	24.52	24.93
846	84.6	94.0	24.56	24.96
847	84.7	94.1	24.60	25.00
848	84.8	94.2	24.64	25.03
849	84.9	94.3	24.68	25.07
850	85.0	94.4	24.72	25.10
851	85.1	94.6	24.76	25.14
852	85.2	94.7	24.80	25.17
853	85.3	94.8	24.84	25.21
854	85.4	94.9	24.88	25.24
855	85.5	95.0	24.92	25.28
856	85.6	95.1	24.96	25.31
857	85.7	95.2	25.00	25.35
858	85.8	95.3	25.04	25.38
859	85.9	95.4	25.08	25.42
860	86.0	95.6	25.12	25.46
861	86.1	95.7	25.16	25.49
862	86.2	95.8	25.20	25.53
863	86.3	95.9	25.24	25.56
864	86.4	96.0	25.28	25.60
865	86.5	96.1	25.32	25.63
866	86.6	96.2	25.36	25.67
867	86.7	96.3	25.40	25.70
868	86.8	96.4	25.44	25.74
869	86.9	96.6	25.48	25.78

【PUHY-P900SM-E】

室内ユニット 合計容量	能力 (kW)		入力 (kW)	
	冷房	暖房	冷房	暖房
870	87.0	96.7	25.52	25.81
871	87.1	96.8	25.56	25.85
872	87.2	96.9	25.60	25.88
873	87.3	97.0	25.64	25.92
874	87.4	97.1	25.68	25.95
875	87.5	97.2	25.72	25.99
876	87.6	97.3	25.76	26.03
877	87.7	97.4	25.80	26.06
878	87.8	97.6	25.84	26.10
879	87.9	97.7	25.88	26.13
880	88.0	97.8	25.92	26.17
881	88.1	97.9	25.96	26.21
882	88.2	98.0	26.01	26.24
883	88.3	98.1	26.05	26.28
884	88.4	98.2	26.09	26.31
885	88.5	98.3	26.13	26.35
886	88.6	98.4	26.17	26.39
887	88.7	98.6	26.21	26.42
888	88.8	98.7	26.25	26.46
889	88.9	98.8	26.29	26.50
890	89.0	98.9	26.33	26.53
891	89.1	99.0	26.37	26.57
892	89.2	99.1	26.41	26.61
893	89.3	99.2	26.45	26.64
894	89.4	99.3	26.49	26.68
895	89.5	99.4	26.54	26.71
896	89.6	100.0	26.58	26.75
897	89.7	100.0	26.62	26.79
898	89.8	100.0	26.66	26.82
899	89.9	100.0	26.70	26.86
900	90.0	100.0	26.75	26.90
901	90.0	100.0	26.75	26.90
902	90.0	100.0	26.75	26.89
903	90.1	100.0	26.75	26.88
904	90.1	100.0	26.75	26.87
905	90.1	100.0	26.75	26.87
906	90.1	100.0	26.75	26.86
907	90.1	100.0	26.75	26.85
908	90.1	100.0	26.75	26.85
909	90.2	100.0	26.75	26.84
910	90.2	100.0	26.76	26.83
911	90.2	100.0	26.76	26.82
912	90.2	100.0	26.76	26.82
913	90.2	100.0	26.76	26.81
914	90.3	100.0	26.76	26.80
915	90.3	100.0	26.76	26.80
916	90.3	100.0	26.76	26.79
917	90.3	100.0	26.76	26.78
918	90.3	100.0	26.76	26.77
919	90.3	100.0	26.76	26.77
920	90.4	100.0	26.76	26.76
921	90.4	100.0	26.76	26.75
922	90.4	100.0	26.76	26.75
923	90.4	100.0	26.76	26.74
924	90.4	100.0	26.76	26.73
925	90.5	100.0	26.76	26.72
926	90.5	100.0	26.76	26.72
927	90.5	100.0	26.76	26.71
928	90.5	100.0	26.76	26.70
929	90.5	100.1	26.76	26.69
930	90.6	100.1	26.76	26.69
931	90.6	100.1	26.76	26.68
932	90.6	100.1	26.77	26.67
933	90.6	100.1	26.77	26.67
934	90.6	100.1	26.77	26.66
935	90.6	100.1	26.77	26.65
936	90.7	100.1	26.77	26.64
937	90.7	100.1	26.77	26.64
938	90.7	100.1	26.77	26.63
939	90.7	100.1	26.77	26.62

室内ユニット 合計容量	能力 (kW)		入力 (kW)	
	冷房	暖房	冷房	暖房
940	90.7	100.1	26.77	26.62
941	90.8	100.1	26.77	26.61
942	90.8	100.1	26.77	26.60
943	90.8	100.1	26.77	26.59
944	90.8	100.1	26.77	26.59
945	90.8	100.1	26.77	26.58
946	90.8	100.1	26.77	26.57
947	90.9	100.1	26.77	26.56
948	90.9	100.1	26.77	26.56
949	90.9	100.1	26.77	26.55
950	90.9	100.1	26.77	26.54
951	90.9	100.1	26.77	26.54
952	91.0	100.1	26.77	26.53
953	91.0	100.1	26.77	26.52
954	91.0	100.1	26.78	26.51
955	91.0	100.1	26.78	26.51
956	91.0	100.1	26.78	26.50
957	91.1	100.1	26.78	26.49
958	91.1	100.1	26.78	26.49
959	91.1	100.1	26.78	26.48
960	91.1	100.1	26.78	26.47
961	91.1	100.1	26.78	26.46
962	91.1	100.1	26.78	26.46
963	91.2	100.1	26.78	26.45
964	91.2	100.1	26.78	26.44
965	91.2	100.1	26.78	26.44
966	91.2	100.1	26.78	26.43
967	91.2	100.1	26.78	26.42
968	91.3	100.1	26.78	26.41
969	91.3	100.1	26.78	26.41
970	91.3	100.1	26.78	26.40
971	91.3	100.1	26.78	26.39
972	91.3	100.1	26.78	26.38
973	91.3	100.1	26.78	26.38
974	91.4	100.1	26.78	26.37
975	91.4	100.1	26.78	26.36
976	91.4	100.1	26.79	26.36
977	91.4	100.1	26.79	26.35
978	91.4	100.1	26.79	26.34
979	91.5	100.1	26.79	26.33
980	91.5	100.1	26.79	26.33
981	91.5	100.1	26.79	26.32
982	91.5	100.2	26.79	26.31
983	91.5	100.2	26.79	26.31
984	91.6	100.2	26.79	26.30
985	91.6	100.2	26.79	26.29
986	91.6	100.2	26.79	26.28
987	91.6	100.2	26.79	26.28
988	91.6	100.2	26.79	26.27
989	91.6	100.2	26.79	26.26
990	91.7	100.2	26.79	26.26
991	91.7	100.2	26.79	26.25
992	91.7	100.2	26.79	26.24
993	91.7	100.2	26.79	26.23
994	91.7	100.2	26.79	26.23
995	91.8	100.2	26.79	26.22
996	91.8	100.2	26.79	26.21
997	91.8	100.2	26.79	26.20
998	91.8	100.2	26.80	26.20
999	91.8	100.2	26.80	26.19
1000	91.9	100.2	26.80	26.18
1001	91.9	100.2	26.80	26.18
1002	91.9	100.2	26.80	26.17
1003	91.9	100.2	26.80	26.16
1004	91.9	100.2	26.80	26.15
1005	91.9	100.2	26.80	26.15
1006	92.0	100.2	26.80	26.14
1007	92.0	100.2	26.80	26.13
1008	92.0	100.2	26.80	26.13
1009	92.0	100.2	26.80	26.12

室内ユニット 合計容量	能力 (kW)		入力 (kW)	
	冷房	暖房	冷房	暖房
1010	92.0	100.2	26.80	26.11
1011	92.1	100.2	26.80	26.10
1012	92.1	100.2	26.80	26.10
1013	92.1	100.2	26.80	26.09
1014	92.1	100.2	26.80	26.08
1015	92.1	100.2	26.80	26.07
1016	92.1	100.2	26.80	26.07
1017	92.2	100.2	26.80	26.06
1018	92.2	100.2	26.80	26.05
1019	92.2	100.2	26.80	26.05
1020	92.2	100.2	26.81	26.04
1021	92.2	100.2	26.81	26.03
1022	92.3	100.2	26.81	26.02
1023	92.3	100.2	26.81	26.02
1024	92.3	100.2	26.81	26.01
1025	92.3	100.2	26.81	26.00
1026	92.3	100.2	26.81	26.00
1027	92.4	100.2	26.81	25.99
1028	92.4	100.2	26.81	25.98
1029	92.4	100.2	26.81	25.97
1030	92.4	100.2	26.81	25.97
1031	92.4	100.2	26.81	25.96
1032	92.4	100.2	26.81	25.95
1033	92.5	100.2	26.81	25.95
1034	92.5	100.3	26.81	25.94
1035	92.5	100.3	26.81	25.93
1036	92.5	100.3	26.81	25.92
1037	92.5	100.3	26.81	25.92
1038	92.6	100.3	26.81	25.91
1039	92.6	100.3	26.81	25.90
1040	92.6	100.3	26.81	25.89
1041	92.6	100.3	26.81	25.89
1042	92.6	100.3	26.82	25.88
1043	92.6	100.3	26.82	25.87
1044	92.7	100.3	26.82	25.87
1045	92.7	100.3	26.82	25.86
1046	92.7	100.3	26.82	25.85
1047	92.7	100.3	26.82	25.84
1048	92.7	100.3	26.82	25.84
1049	92.8	100.3	26.82	25.83
1050	92.8	100.3	26.82	25.82
1051	92.8	100.3	26.82	25.82
1052	92.8	100.3	26.82	25.81
1053	92.8	100.3	26.82	25.80
1054	92.9	100.3	26.82	25.79
1055	92.9	100.3	26.82	25.79
1056	92.9	100.3	26.82	25.78
1057	92.9	100.3	26.82	25.77
1058	92.9	100.3	26.82	25.76
1059	92.9	100.3	26.82	25.76
1060	93.0	100.3	26.82	25.75
1061	93.0	100.3	26.82	25.74
1062	93.0	100.3	26.82	25.74
1063	93.0	100.3	26.82	25.73
1064	93.0	100.3	26.83	25.72
1065	93.1	100.3	26.83	25.71
1066	93.1	100.3	26.83	25.71
1067	93.1	100.3	26.83	25.70
1068	93.1	100.3	26.83	25.69
1069	93.1	100.3	26.83	25.69
1070	93.1	100.3	26.83	25.68
1071	93.2	100.3	26.83	25.67
1072	93.2	100.3	26.83	25.66
1073	93.2	100.3	26.83	25.66
1074	93.2	100.3	26.83	25.65
1075	93.2	100.3	26.83	25.64
1076	93.3	100.3	26.83	25.64
1077	93.3	100.3	26.83	25.63
1078	93.3	100.3	26.83	25.62
1079	93.3	100.3	26.83	25.61

## 【PUHY-P900SM-E】

室内ユニット 合計容量	能力 (kW)		入力 (kW)	
	冷房	暖房	冷房	暖房
1080	93.3	100.3	26.83	25.61
1081	93.4	100.3	26.83	25.60
1082	93.4	100.3	26.83	25.59
1083	93.4	100.3	26.83	25.58
1084	93.4	100.3	26.83	25.58
1085	93.4	100.3	26.83	25.57
1086	93.4	100.3	26.84	25.56
1087	93.5	100.4	26.84	25.56
1088	93.5	100.4	26.84	25.55
1089	93.5	100.4	26.84	25.54
1090	93.5	100.4	26.84	25.53
1091	93.5	100.4	26.84	25.53
1092	93.6	100.4	26.84	25.52
1093	93.6	100.4	26.84	25.51
1094	93.6	100.4	26.84	25.51
1095	93.6	100.4	26.84	25.50
1096	93.6	100.4	26.84	25.49
1097	93.6	100.4	26.84	25.48
1098	93.7	100.4	26.84	25.48
1099	93.7	100.4	26.84	25.47
1100	93.7	100.4	26.84	25.46
1101	93.7	100.4	26.84	25.46
1102	93.7	100.4	26.84	25.45
1103	93.8	100.4	26.84	25.44
1104	93.8	100.4	26.84	25.43
1105	93.8	100.4	26.84	25.43
1106	93.8	100.4	26.84	25.42
1107	93.8	100.4	26.84	25.41
1108	93.9	100.4	26.85	25.40
1109	93.9	100.4	26.85	25.40
1110	93.9	100.4	26.85	25.39
1111	93.9	100.4	26.85	25.38
1112	93.9	100.4	26.85	25.38
1113	93.9	100.4	26.85	25.37
1114	94.0	100.4	26.85	25.36
1115	94.0	100.4	26.85	25.35
1116	94.0	100.4	26.85	25.35
1117	94.0	100.4	26.85	25.34
1118	94.0	100.4	26.85	25.33
1119	94.1	100.4	26.85	25.33
1120	94.1	100.4	26.85	25.32
1121	94.1	100.4	26.85	25.31
1122	94.1	100.4	26.85	25.30
1123	94.1	100.4	26.85	25.30
1124	94.1	100.4	26.85	25.29
1125	94.2	100.4	26.85	25.28
1126	94.2	100.4	26.85	25.27
1127	94.2	100.4	26.85	25.27
1128	94.2	100.4	26.85	25.26
1129	94.2	100.4	26.85	25.25
1130	94.3	100.4	26.86	25.25
1131	94.3	100.4	26.86	25.24
1132	94.3	100.4	26.86	25.23
1133	94.3	100.4	26.86	25.22
1134	94.3	100.4	26.86	25.22
1135	94.4	100.4	26.86	25.21
1136	94.4	100.4	26.86	25.20
1137	94.4	100.4	26.86	25.20
1138	94.4	100.4	26.86	25.19
1139	94.4	100.5	26.86	25.18
1140	94.4	100.5	26.86	25.17
1141	94.5	100.5	26.86	25.17
1142	94.5	100.5	26.86	25.16
1143	94.5	100.5	26.86	25.15
1144	94.5	100.5	26.86	25.15
1145	94.5	100.5	26.86	25.14
1146	94.6	100.5	26.86	25.13
1147	94.6	100.5	26.86	25.12
1148	94.6	100.5	26.86	25.12
1149	94.6	100.5	26.86	25.11

室内ユニット 合計容量	能力 (kW)		入力 (kW)	
	冷房	暖房	冷房	暖房
1150	94.6	100.5	26.86	25.10
1151	94.6	100.5	26.86	25.09
1152	94.7	100.5	26.87	25.09
1153	94.7	100.5	26.87	25.08
1154	94.7	100.5	26.87	25.07
1155	94.7	100.5	26.87	25.07
1156	94.7	100.5	26.87	25.06
1157	94.8	100.5	26.87	25.05
1158	94.8	100.5	26.87	25.04
1159	94.8	100.5	26.87	25.04
1160	94.8	100.5	26.87	25.03
1161	94.8	100.5	26.87	25.02
1162	94.9	100.5	26.87	25.02
1163	94.9	100.5	26.87	25.01
1164	94.9	100.5	26.87	25.00
1165	94.9	100.5	26.87	24.99
1166	94.9	100.5	26.87	24.99
1167	94.9	100.5	26.87	24.98
1168	95.0	100.5	26.87	24.97
1169	95.0	100.5	26.87	24.97
1170	95.0	100.5	26.87	24.96

b. 空気条件変化による補正

【PUHY-P784・P840・P900SM-E】

・冷房能力・入力補正

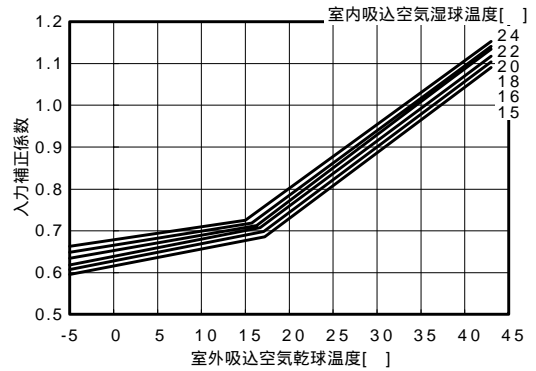
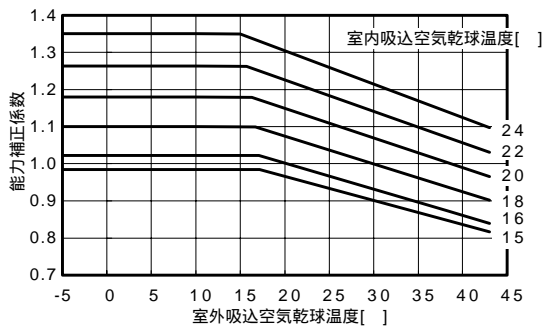

・暖房能力・入力補正

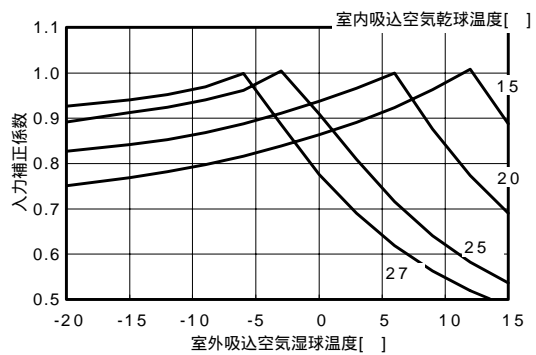
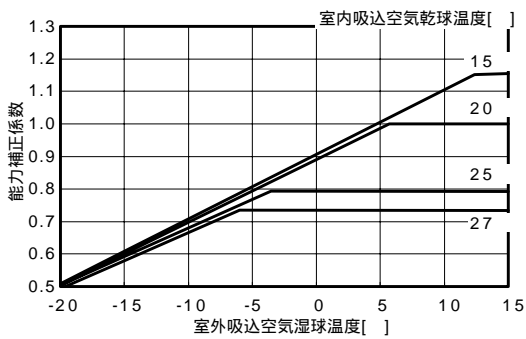

・冷房能力・入力補正（オールフレッシュ）

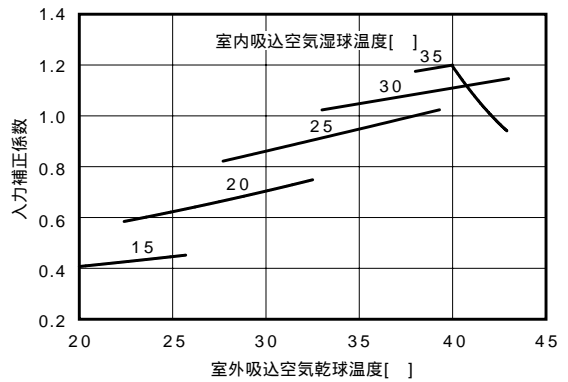
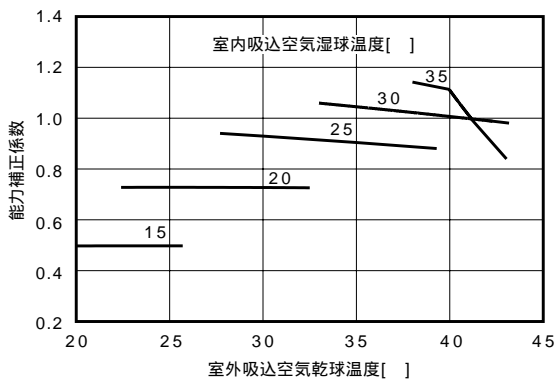

・暖房能力・入力補正（オールフレッシュ）

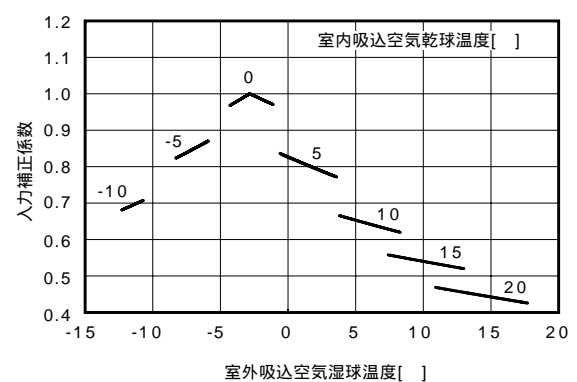
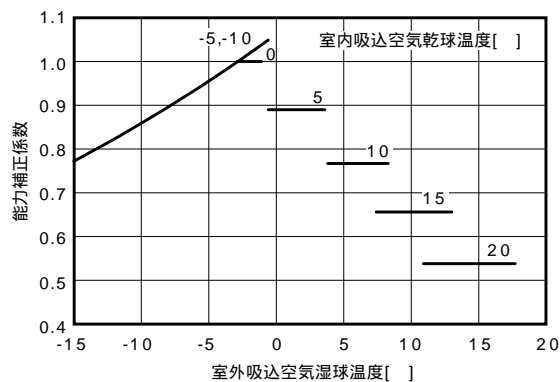



c. 冷媒配管長補正

【冷房能力補正係数】

【PUHY-P784SM-E】

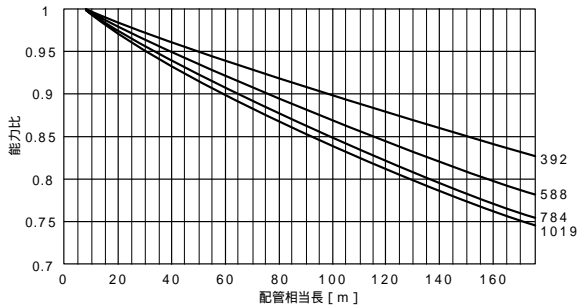

【PUHY-P840SM-E】

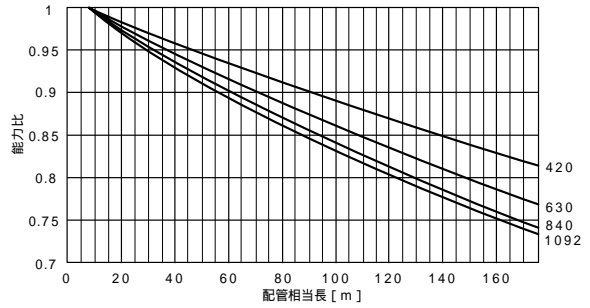

【PUHY-P900SM-E】

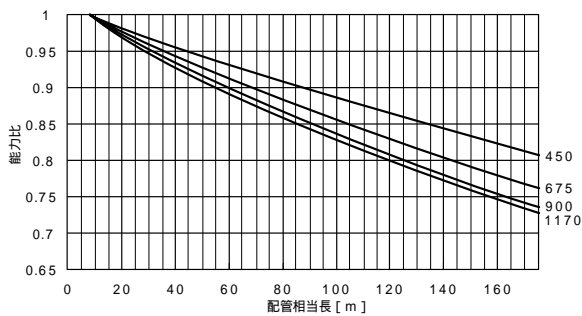

【暖房能力補正係数】

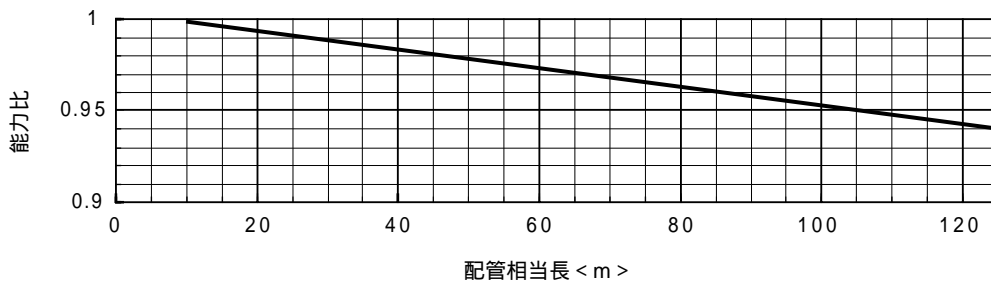

【配管相当長の求め方】

- PUHY-P784SM-E形 相当長 = (最遠室内ユニットまでの配管実長) + (0.70 × 配管途中のバンド数) m
- PUHY-P840SM-E形 相当長 = (最遠室内ユニットまでの配管実長) + (0.70 × 配管途中のバンド数) m
- PUHY-P900SM-E形 相当長 = (最遠室内ユニットまでの配管実長) + (0.70 × 配管途中のバンド数) m

d. 霜取補正

室外吸込空気温度 < 湿球温度 >		6	4	2	1	0	-2	-4	-6	-8	-10
霜取補正係数	50Hz	1.0	0.98	0.89	0.879	0.89	0.90	0.92	0.95	0.95	0.95
	60Hz	1.0	0.98	0.89	0.879	0.89	0.90	0.92	0.95	0.95	0.95

P960~P1400SKM-E形

a. 標準能力表

【PUHY-P960SKM-E】

室内ユニット 合計容量	能力 (kW)		入力 (kW)	
	冷房	暖房	冷房	暖房
480	48.0	54.0	14.37	15.73
481	48.1	54.1	14.40	15.77
482	48.2	54.2	14.44	15.81
483	48.3	54.3	14.48	15.85
484	48.4	54.5	14.51	15.89
485	48.5	54.6	14.55	15.93
486	48.6	54.7	14.59	15.97
487	48.7	54.8	14.62	16.01
488	48.8	54.9	14.66	16.05
489	48.9	55.0	14.69	16.08
490	49.0	55.1	14.73	16.12
491	49.1	55.2	14.77	16.16
492	49.2	55.4	14.80	16.20
493	49.3	55.5	14.84	16.24
494	49.4	55.6	14.87	16.28
495	49.5	55.7	14.91	16.31
496	49.6	55.8	14.95	16.35
497	49.7	55.9	14.98	16.39
498	49.8	56.0	15.02	16.43
499	49.9	56.1	15.05	16.47
500	50.0	56.3	15.09	16.51
501	50.1	56.4	15.12	16.54
502	50.2	56.5	15.16	16.58
503	50.3	56.6	15.19	16.62
504	50.4	56.7	15.23	16.66
505	50.5	56.8	15.27	16.69
506	50.6	56.9	15.30	16.73
507	50.7	57.0	15.34	16.77
508	50.8	57.2	15.37	16.81
509	50.9	57.3	15.41	16.84
510	51.0	57.4	15.44	16.88
511	51.1	57.5	15.48	16.92
512	51.2	57.6	15.51	16.96
513	51.3	57.7	15.55	16.99
514	51.4	57.8	15.58	17.03
515	51.5	57.9	15.62	17.07
516	51.6	58.1	15.65	17.10
517	51.7	58.2	15.68	17.14
518	51.8	58.3	15.72	17.18
519	51.9	58.4	15.75	17.21
520	52.0	58.5	15.79	17.25
521	52.1	58.6	15.82	17.29
522	52.2	58.7	15.86	17.32
523	52.3	58.8	15.89	17.36
524	52.4	59.0	15.92	17.40
525	52.5	59.1	15.96	17.43
526	52.6	59.2	15.99	17.47
527	52.7	59.3	16.03	17.51
528	52.8	59.4	16.06	17.54
529	52.9	59.5	16.09	17.58
530	53.0	59.6	16.13	17.61
531	53.1	59.7	16.16	17.65
532	53.2	59.9	16.20	17.69
533	53.3	60.0	16.23	17.72
534	53.4	60.1	16.26	17.76
535	53.5	60.2	16.30	17.79
536	53.6	60.3	16.33	17.83
537	53.7	60.4	16.36	17.87
538	53.8	60.5	16.40	17.90
539	53.9	60.6	16.43	17.94
540	54.0	60.8	16.46	17.97
541	54.1	60.9	16.50	18.01
542	54.2	61.0	16.53	18.04
543	54.3	61.1	16.56	18.08
544	54.4	61.2	16.60	18.11
545	54.5	61.3	16.63	18.15
546	54.6	61.4	16.66	18.18
547	54.7	61.5	16.70	18.22
548	54.8	61.7	16.73	18.25
549	54.9	61.8	16.76	18.29

室内ユニット 合計容量	能力 (kW)		入力 (kW)	
	冷房	暖房	冷房	暖房
550	55.0	61.9	16.79	18.32
551	55.1	62.0	16.83	18.36
552	55.2	62.1	16.86	18.39
553	55.3	62.2	16.89	18.43
554	55.4	62.3	16.92	18.46
555	55.5	62.4	16.96	18.50
556	55.6	62.6	16.99	18.53
557	55.7	62.7	17.02	18.57
558	55.8	62.8	17.05	18.60
559	55.9	62.9	17.08	18.63
560	56.0	63.0	17.12	18.67
561	56.1	63.1	17.15	18.70
562	56.2	63.2	17.18	18.74
563	56.3	63.3	17.21	18.77
564	56.4	63.5	17.24	18.80
565	56.5	63.6	17.28	18.84
566	56.6	63.7	17.31	18.87
567	56.7	63.8	17.34	18.91
568	56.8	63.9	17.37	18.94
569	56.9	64.0	17.40	18.97
570	57.0	64.1	17.43	19.01
571	57.1	64.2	17.47	19.04
572	57.2	64.4	17.50	19.07
573	57.3	64.5	17.53	19.11
574	57.4	64.6	17.56	19.14
575	57.5	64.7	17.59	19.17
576	57.6	64.8	17.62	19.21
577	57.7	64.9	17.65	19.24
578	57.8	65.0	17.68	19.27
579	57.9	65.1	17.72	19.31
580	58.0	65.3	17.75	19.34
581	58.1	65.4	17.78	19.37
582	58.2	65.5	17.81	19.41
583	58.3	65.6	17.84	19.44
584	58.4	65.7	17.87	19.47
585	58.5	65.8	17.90	19.50
586	58.6	65.9	17.93	19.54
587	58.7	66.0	17.96	19.57
588	58.8	66.2	17.99	19.60
589	58.9	66.3	18.02	19.64
590	59.0	66.4	18.05	19.67
591	59.1	66.5	18.08	19.70
592	59.2	66.6	18.11	19.73
593	59.3	66.7	18.14	19.76
594	59.4	66.8	18.17	19.80
595	59.5	66.9	18.20	19.83
596	59.6	67.1	18.23	19.86
597	59.7	67.2	18.26	19.89
598	59.8	67.3	18.29	19.92
599	59.9	67.4	18.32	19.96
600	60.0	67.5	18.35	19.99
601	60.1	67.6	18.38	20.02
602	60.2	67.7	18.41	20.05
603	60.3	67.8	18.44	20.08
604	60.4	68.0	18.47	20.12
605	60.5	68.1	18.50	20.15
606	60.6	68.2	18.53	20.18
607	60.7	68.3	18.56	20.21
608	60.8	68.4	18.59	20.24
609	60.9	68.5	18.62	20.27
610	61.0	68.6	18.65	20.30
611	61.1	68.7	18.68	20.33
612	61.2	68.9	18.70	20.37
613	61.3	69.0	18.73	20.40
614	61.4	69.1	18.76	20.43
615	61.5	69.2	18.79	20.46
616	61.6	69.3	18.82	20.49
617	61.7	69.4	18.85	20.52
618	61.8	69.5	18.88	20.55
619	61.9	69.6	18.91	20.58

室内ユニット 合計容量	能力 (kW)		入力 (kW)	
	冷房	暖房	冷房	暖房
620	62.0	69.8	18.94	20.61
621	62.1	69.9	18.96	20.64
622	62.2	70.0	18.99	20.67
623	62.3	70.1	19.02	20.70
624	62.4	70.2	19.05	20.73
625	62.5	70.3	19.08	20.76
626	62.6	70.4	19.11	20.79
627	62.7	70.5	19.13	20.82
628	62.8	70.7	19.16	20.85
629	62.9	70.8	19.19	20.88
630	63.0	70.9	19.22	20.91
631	63.1	71.0	19.25	20.94
632	63.2	71.1	19.27	20.97
633	63.3	71.2	19.30	21.00
634	63.4	71.3	19.33	21.03
635	63.5	71.4	19.36	21.06
636	63.6	71.6	19.38	21.09
637	63.7	71.7	19.41	21.12
638	63.8	71.8	19.44	21.15
639	63.9	71.9	19.47	21.18
640	64.0	72.0	19.49	21.21
641	64.1	72.1	19.52	21.24
642	64.2	72.2	19.55	21.27
643	64.3	72.3	19.58	21.30
644	64.4	72.5	19.60	21.33
645	64.5	72.6	19.63	21.36
646	64.6	72.7	19.66	21.39
647	64.7	72.8	19.69	21.41
648	64.8	72.9	19.71	21.44
649	64.9	73.0	19.74	21.47
650	65.0	73.1	19.77	21.50
651	65.1	73.2	19.79	21.53
652	65.2	73.4	19.82	21.56
653	65.3	73.5	19.85	21.59
654	65.4	73.6	19.87	21.62
655	65.5	73.7	19.90	21.64
656	65.6	73.8	19.93	21.67
657	65.7	73.9	19.95	21.70
658	65.8	74.0	19.98	21.73
659	65.9	74.1	20.01	21.76
660	66.0	74.3	20.03	21.79
661	66.1	74.4	20.06	21.81
662	66.2	74.5	20.08	21.84
663	66.3	74.6	20.11	21.87
664	66.4	74.7	20.14	21.90
665	66.5	74.8	20.16	21.92
666	66.6	74.9	20.19	21.95
667	66.7	75.0	20.21	21.98
668	66.8	75.2	20.24	22.01
669	66.9	75.3	20.27	22.04
670	67.0	75.4	20.29	22.06
671	67.1	75.5	20.32	22.09
672	67.2	75.6	20.34	22.12
673	67.3	75.7	20.37	22.15
674	67.4	75.8	20.39	22.17
675	67.5	75.9	20.42	22.20
676	67.6	76.1	20.44	22.23
677	67.7	76.2	20.47	22.25
678	67.8	76.3	20.49	22.28
679	67.9	76.4	20.52	22.31
680	68.0	76.5	20.54	22.34
681	68.1	76.6	20.57	22.36
682	68.2	76.7	20.59	22.39
683	68.3	76.8	20.62	22.42
684	68.4	77.0	20.64	22.44
685	68.5	77.1	20.67	22.47
686	68.6	77.2	20.69	22.50
687	68.7	77.3	20.72	22.52
688	68.8	77.4	20.74	22.55
689	68.9	77.5	20.77	22.57

## 【PUHY-P960SKM-E】

室内ユニット 合計容量	能力 (kW)		入力 (kW)	
	冷房	暖房	冷房	暖房
690	69.0	77.6	20.79	22.60
691	69.1	77.7	20.82	22.63
692	69.2	77.9	20.84	22.65
693	69.3	78.0	20.87	22.68
694	69.4	78.1	20.89	22.71
695	69.5	78.2	20.91	22.73
696	69.6	78.3	20.94	22.76
697	69.7	78.4	20.96	22.78
698	69.8	78.5	20.99	22.81
699	69.9	78.6	21.01	22.83
700	70.0	78.8	21.03	22.86
701	70.1	78.9	21.06	22.89
702	70.2	79.0	21.08	22.91
703	70.3	79.1	21.11	22.94
704	70.4	79.2	21.13	22.96
705	70.5	79.3	21.15	22.99
706	70.6	79.4	21.18	23.01
707	70.7	79.5	21.20	23.04
708	70.8	79.7	21.22	23.06
709	70.9	79.8	21.25	23.09
710	71.0	79.9	21.27	23.11
711	71.1	80.0	21.29	23.14
712	71.2	80.1	21.32	23.16
713	71.3	80.2	21.34	23.19
714	71.4	80.3	21.36	23.21
715	71.5	80.4	21.39	23.24
716	71.6	80.6	21.41	23.26
717	71.7	80.7	21.43	23.29
718	71.8	80.8	21.45	23.31
719	71.9	80.9	21.48	23.34
720	72.0	81.0	21.50	23.36
721	72.1	81.1	21.52	23.39
722	72.2	81.2	21.55	23.41
723	72.3	81.3	21.57	23.43
724	72.4	81.5	21.59	23.46
725	72.5	81.6	21.61	23.48
726	72.6	81.7	21.64	23.51
727	72.7	81.8	21.66	23.53
728	72.8	81.9	21.68	23.56
729	72.9	82.0	21.70	23.58
730	73.0	82.1	21.73	23.60
731	73.1	82.2	21.75	23.63
732	73.2	82.4	21.77	23.65
733	73.3	82.5	21.79	23.67
734	73.4	82.6	21.81	23.70
735	73.5	82.7	21.84	23.72
736	73.6	82.8	21.86	23.74
737	73.7	82.9	21.88	23.77
738	73.8	83.0	21.90	23.79
739	73.9	83.1	21.92	23.82
740	74.0	83.3	21.94	23.84
741	74.1	83.4	21.97	23.86
742	74.2	83.5	21.99	23.88
743	74.3	83.6	22.01	23.91
744	74.4	83.7	22.03	23.93
745	74.5	83.8	22.05	23.95
746	74.6	83.9	22.07	23.98
747	74.7	84.0	22.09	24.00
748	74.8	84.2	22.11	24.02
749	74.9	84.3	22.14	24.04
750	75.0	84.4	22.16	24.07
751	75.1	84.5	22.18	24.09
752	75.2	84.6	22.20	24.11
753	75.3	84.7	22.22	24.14
754	75.4	84.8	22.24	24.16
755	75.5	84.9	22.26	24.18
756	75.6	85.1	22.28	24.20
757	75.7	85.2	22.30	24.22
758	75.8	85.3	22.32	24.25
759	75.9	85.4	22.34	24.27

室内ユニット 合計容量	能力 (kW)		入力 (kW)	
	冷房	暖房	冷房	暖房
760	76.0	85.5	22.36	24.29
761	76.1	85.6	22.38	24.31
762	76.2	85.7	22.40	24.33
763	76.3	85.8	22.42	24.36
764	76.4	86.0	22.44	24.38
765	76.5	86.1	22.47	24.40
766	76.6	86.2	22.49	24.42
767	76.7	86.3	22.51	24.44
768	76.8	86.4	22.53	24.46
769	76.9	86.5	22.55	24.49
770	77.0	86.6	22.56	24.51
771	77.1	86.7	22.58	24.53
772	77.2	86.9	22.60	24.55
773	77.3	87.0	22.62	24.57
774	77.4	87.1	22.64	24.59
775	77.5	87.2	22.66	24.61
776	77.6	87.3	22.68	24.63
777	77.7	87.4	22.70	24.66
778	77.8	87.5	22.72	24.68
779	77.9	87.6	22.74	24.70
780	78.0	87.8	22.76	24.72
781	78.1	87.9	22.78	24.74
782	78.2	88.0	22.80	24.76
783	78.3	88.1	22.82	24.78
784	78.4	88.2	22.84	24.80
785	78.5	88.3	22.86	24.82
786	78.6	88.4	22.87	24.84
787	78.7	88.5	22.89	24.86
788	78.8	88.7	22.91	24.88
789	78.9	88.8	22.93	24.90
790	79.0	88.9	22.95	24.92
791	79.1	89.0	22.97	24.94
792	79.2	89.1	22.99	24.96
793	79.3	89.2	23.01	24.98
794	79.4	89.3	23.02	25.00
795	79.5	89.4	23.04	25.02
796	79.6	89.6	23.06	25.04
797	79.7	89.7	23.08	25.06
798	79.8	89.8	23.10	25.08
799	79.9	89.9	23.12	25.10
800	80.0	90.0	23.13	25.12
801	80.1	90.1	23.15	25.14
802	80.2	90.2	23.17	25.16
803	80.3	90.3	23.19	25.18
804	80.4	90.5	23.21	25.20
805	80.5	90.6	23.22	25.22
806	80.6	90.7	23.24	25.24
807	80.7	90.8	23.26	25.26
808	80.8	90.9	23.28	25.28
809	80.9	91.0	23.29	25.30
810	81.0	91.1	23.31	25.31
811	81.1	91.2	23.33	25.33
812	81.2	91.4	23.35	25.35
813	81.3	91.5	23.36	25.37
814	81.4	91.6	23.38	25.39
815	81.5	91.7	23.40	25.41
816	81.6	91.8	23.42	25.43
817	81.7	91.9	23.43	25.45
818	81.8	92.0	23.45	25.46
819	81.9	92.1	23.47	25.48
820	82.0	92.3	23.48	25.50
821	82.1	92.4	23.50	25.52
822	82.2	92.5	23.52	25.54
823	82.3	92.6	23.53	25.56
824	82.4	92.7	23.55	25.57
825	82.5	92.8	23.57	25.59
826	82.6	92.9	23.58	25.61
827	82.7	93.0	23.60	25.63
828	82.8	93.2	23.62	25.65
829	82.9	93.3	23.63	25.66

室内ユニット 合計容量	能力 (kW)		入力 (kW)	
	冷房	暖房	冷房	暖房
830	83.0	93.4	23.65	25.68
831	83.1	93.5	23.67	25.70
832	83.2	93.6	23.68	25.72
833	83.3	93.7	23.70	25.73
834	83.4	93.8	23.71	25.75
835	83.5	93.9	23.73	25.77
836	83.6	94.1	23.75	25.79
837	83.7	94.2	23.76	25.80
838	83.8	94.3	23.78	25.82
839	83.9	94.4	23.79	25.84
840	84.0	94.5	23.81	25.85
841	84.1	94.6	23.83	25.87
842	84.2	94.7	23.84	25.89
843	84.3	94.8	23.86	25.91
844	84.4	95.0	23.87	25.92
845	84.5	95.1	23.89	25.94
846	84.6	95.2	23.90	25.96
847	84.7	95.3	23.92	25.97
848	84.8	95.4	23.93	25.99
849	84.9	95.5	23.95	26.01
850	85.0	95.6	23.97	26.02
851	85.1	95.7	23.98	26.04
852	85.2	95.9	24.00	26.06
853	85.3	96.0	24.01	26.07
854	85.4	96.1	24.03	26.09
855	85.5	96.2	24.04	26.10
856	85.6	96.3	24.06	26.12
857	85.7	96.4	24.07	26.14
858	85.8	96.5	24.08	26.15
859	85.9	96.6	24.10	26.17
860	86.0	96.8	24.11	26.18
861	86.1	96.9	24.13	26.20
862	86.2	97.0	24.14	26.22
863	86.3	97.1	24.16	26.23
864	86.4	97.2	24.17	26.25
865	86.5	97.3	24.19	26.26
866	86.6	97.4	24.20	26.28
867	86.7	97.5	24.21	26.29
868	86.8	97.7	24.23	26.31
869	86.9	97.8	24.24	26.33
870	87.0	97.9	24.26	26.34
871	87.1	98.0	24.27	26.36
872	87.2	98.1	24.28	26.37
873	87.3	98.2	24.30	26.39
874	87.4	98.3	24.31	26.40
875	87.5	98.4	24.33	26.42
876	87.6	98.6	24.34	26.43
877	87.7	98.7	24.35	26.45
878	87.8	98.8	24.37	26.46
879	87.9	98.9	24.38	26.48
880	88.0	99.0	24.39	26.49
881	88.1	99.1	24.41	26.50
882	88.2	99.2	24.42	26.52
883	88.3	99.3	24.43	26.53
884	88.4	99.5	24.45	26.55
885	88.5	99.6	24.46	26.56
886	88.6	99.7	24.47	26.58
887	88.7	99.8	24.49	26.59
888	88.8	99.9	24.50	26.61
889	88.9	100.0	24.51	26.62
890	89.0	100.1	24.53	26.63
891	89.1	100.2	24.54	26.65
892	89.2	100.4	24.55	26.66
893	89.3	100.5	24.56	26.68
894	89.4	100.6	24.58	26.69
895	89.5	100.7	24.59	26.70
896	89.6	100.8	24.60	26.72
897	89.7	100.9	24.61	26.73
898	89.8	101.0	24.63	26.74
899	89.9	101.1	24.64	26.76

## 【PUHY-P960SKM-E】

室内ユニット 合計容量	能力 (kW)		入力 (kW)	
	冷房	暖房	冷房	暖房
900	90.0	101.3	24.65	26.77
901	90.1	101.4	24.66	26.78
902	90.2	101.5	24.68	26.80
903	90.3	101.6	24.69	26.81
904	90.4	101.7	24.70	26.82
905	90.5	101.8	24.71	26.84
906	90.6	101.9	24.72	26.85
907	90.7	102.0	24.74	26.86
908	90.8	102.2	24.75	26.88
909	90.9	102.3	24.76	26.89
910	91.0	102.4	24.77	26.90
911	91.1	102.5	24.78	26.92
912	91.2	102.6	24.79	26.93
913	91.3	102.7	24.81	26.94
914	91.4	102.8	24.82	26.95
915	91.5	102.9	24.83	26.97
916	91.6	103.1	24.84	26.98
917	91.7	103.2	24.85	26.99
918	91.8	103.3	24.86	27.00
919	91.9	103.4	24.87	27.02
920	92.0	103.5	24.88	27.03
921	92.1	103.6	24.90	27.04
922	92.2	103.7	24.91	27.05
923	92.3	103.8	24.92	27.06
924	92.4	104.0	24.93	27.08
925	92.5	104.1	24.94	27.09
926	92.6	104.2	24.95	27.10
927	92.7	104.3	24.96	27.11
928	92.8	104.4	24.97	27.12
929	92.9	104.5	24.98	27.14
930	93.0	104.6	24.99	27.15
931	93.1	104.7	25.00	27.16
932	93.2	104.9	25.01	27.17
933	93.3	105.0	25.02	27.18
934	93.4	105.1	25.03	27.19
935	93.5	105.2	25.04	27.20
936	93.6	105.3	25.05	27.22
937	93.7	105.4	25.06	27.23
938	93.8	105.5	25.07	27.24
939	93.9	105.6	25.08	27.25
940	94.0	105.8	25.09	27.26
941	94.1	105.9	25.10	27.27
942	94.2	106.0	25.11	27.28
943	94.3	106.1	25.12	27.29
944	94.4	106.2	25.13	27.30
945	94.5	106.3	25.14	27.31
946	94.6	106.4	25.15	27.33
947	94.7	106.5	25.16	27.34
948	94.8	106.7	25.17	27.35
949	94.9	106.8	25.18	27.36
950	95.0	106.9	25.19	27.37
951	95.1	107.0	25.20	27.38
952	95.2	107.1	25.21	27.39
953	95.3	107.2	25.22	27.40
954	95.4	107.3	25.23	27.41
955	95.5	107.4	25.24	27.42
956	95.6	107.6	25.25	27.43
957	95.7	107.7	25.26	27.44
958	95.8	107.8	25.26	27.45
959	95.9	107.9	25.27	27.46
960	96.0	108.0	25.28	27.47
961	96.0	108.0	25.28	27.46
962	96.1	108.0	25.28	27.46
963	96.1	108.0	25.29	27.45
964	96.1	108.0	25.29	27.44
965	96.1	108.0	25.29	27.43
966	96.2	108.1	25.29	27.43
967	96.2	108.1	25.29	27.42
968	96.2	108.1	25.29	27.41
969	96.2	108.1	25.30	27.41

室内ユニット 合計容量	能力 (kW)		入力 (kW)	
	冷房	暖房	冷房	暖房
970	96.3	108.1	25.30	27.40
971	96.3	108.1	25.30	27.39
972	96.3	108.1	25.30	27.38
973	96.3	108.1	25.30	27.38
974	96.4	108.1	25.30	27.37
975	96.4	108.1	25.31	27.36
976	96.4	108.2	25.31	27.35
977	96.4	108.2	25.31	27.35
978	96.5	108.2	25.31	27.34
979	96.5	108.2	25.31	27.33
980	96.5	108.2	25.32	27.33
981	96.5	108.2	25.32	27.32
982	96.6	108.2	25.32	27.31
983	96.6	108.2	25.32	27.30
984	96.6	108.2	25.32	27.30
985	96.6	108.2	25.32	27.29
986	96.7	108.3	25.33	27.28
987	96.7	108.3	25.33	27.28
988	96.7	108.3	25.33	27.27
989	96.7	108.3	25.33	27.26
990	96.8	108.3	25.33	27.25
991	96.8	108.3	25.33	27.25
992	96.8	108.3	25.34	27.24
993	96.8	108.3	25.34	27.23
994	96.9	108.3	25.34	27.22
995	96.9	108.3	25.34	27.22
996	96.9	108.4	25.34	27.21
997	97.0	108.4	25.35	27.20
998	97.0	108.4	25.35	27.20
999	97.0	108.4	25.35	27.19
1000	97.0	108.4	25.35	27.18
1001	97.1	108.4	25.35	27.17
1002	97.1	108.4	25.35	27.17
1003	97.1	108.4	25.36	27.16
1004	97.1	108.4	25.36	27.15
1005	97.2	108.4	25.36	27.15
1006	97.2	108.4	25.36	27.14
1007	97.2	108.5	25.36	27.13
1008	97.2	108.5	25.37	27.12
1009	97.3	108.5	25.37	27.12
1010	97.3	108.5	25.37	27.11
1011	97.3	108.5	25.37	27.10
1012	97.3	108.5	25.37	27.09
1013	97.4	108.5	25.37	27.09
1014	97.4	108.5	25.38	27.08
1015	97.4	108.5	25.38	27.07
1016	97.4	108.5	25.38	27.07
1017	97.5	108.6	25.38	27.06
1018	97.5	108.6	25.38	27.05
1019	97.5	108.6	25.38	27.04
1020	97.5	108.6	25.39	27.04
1021	97.6	108.6	25.39	27.03
1022	97.6	108.6	25.39	27.02
1023	97.6	108.6	25.39	27.02
1024	97.6	108.6	25.39	27.01
1025	97.7	108.6	25.40	27.00
1026	97.7	108.6	25.40	26.99
1027	97.7	108.7	25.40	26.99
1028	97.7	108.7	25.40	26.98
1029	97.8	108.7	25.40	26.97
1030	97.8	108.7	25.40	26.96
1031	97.8	108.7	25.41	26.96
1032	97.9	108.7	25.41	26.95
1033	97.9	108.7	25.41	26.94
1034	97.9	108.7	25.41	26.94
1035	97.9	108.7	25.41	26.93
1036	98.0	108.7	25.41	26.92
1037	98.0	108.7	25.42	26.91
1038	98.0	108.8	25.42	26.91
1039	98.0	108.8	25.42	26.90

室内ユニット 合計容量	能力 (kW)		入力 (kW)	
	冷房	暖房	冷房	暖房
1040	98.1	108.8	25.42	26.89
1041	98.1	108.8	25.42	26.89
1042	98.1	108.8	25.43	26.88
1043	98.1	108.8	25.43	26.87
1044	98.2	108.8	25.43	26.86
1045	98.2	108.8	25.43	26.86
1046	98.2	108.8	25.43	26.85
1047	98.2	108.8	25.43	26.84
1048	98.3	108.9	25.44	26.83
1049	98.3	108.9	25.44	26.83
1050	98.3	108.9	25.44	26.82
1051	98.3	108.9	25.44	26.81
1052	98.4	108.9	25.44	26.81
1053	98.4	108.9	25.44	26.80
1054	98.4	108.9	25.45	26.79
1055	98.4	108.9	25.45	26.78
1056	98.5	108.9	25.45	26.78
1057	98.5	108.9	25.45	26.77
1058	98.5	109.0	25.45	26.76
1059	98.5	109.0	25.46	26.76
1060	98.6	109.0	25.46	26.75
1061	98.6	109.0	25.46	26.74
1062	98.6	109.0	25.46	26.73
1063	98.6	109.0	25.46	26.73
1064	98.7	109.0	25.46	26.72
1065	98.7	109.0	25.47	26.71
1066	98.7	109.0	25.47	26.70
1067	98.7	109.0	25.47	26.70
1068	98.8	109.1	25.47	26.69
1069	98.8	109.1	25.47	26.68
1070	98.8	109.1	25.47	26.68
1071	98.9	109.1	25.48	26.67
1072	98.9	109.1	25.48	26.66
1073	98.9	109.1	25.48	26.65
1074	98.9	109.1	25.48	26.65
1075	99.0	109.1	25.48	26.64
1076	99.0	109.1	25.49	26.63
1077	99.0	109.1	25.49	26.63
1078	99.0	109.1	25.49	26.62
1079	99.1	109.2	25.49	26.61
1080	99.1	109.2	25.49	26.60
1081	99.1	109.2	25.49	26.60
1082	99.1	109.2	25.50	26.59
1083	99.2	109.2	25.50	26.58
1084	99.2	109.2	25.50	26.57
1085	99.2	109.2	25.50	26.57
1086	99.2	109.2	25.50	26.56
1087	99.3	109.2	25.50	26.55
1088	99.3	109.2	25.51	26.55
1089	99.3	109.3	25.51	26.54
1090	99.3	109.3	25.51	26.53
1091	99.4	109.3	25.51	26.52
1092	99.4	109.3	25.51	26.52
1093	99.4	109.3	25.52	26.51
1094	99.4	109.3	25.52	26.50
1095	99.5	109.3	25.52	26.50
1096	99.5	109.3	25.52	26.49
1097	99.5	109.3	25.52	26.48
1098	99.5	109.3	25.52	26.47
1099	99.6	109.4	25.53	26.47
1100	99.6	109.4	25.53	26.46
1101	99.6	109.4	25.53	26.45
1102	99.6	109.4	25.53	26.44
1103	99.7	109.4	25.53	26.44
1104	99.7	109.4	25.54	26.43
1105	99.7	109.4	25.54	26.42
1106	99.8	109.4	25.54	26.42
1107	99.8	109.4	25.54	26.41
1108	99.8	109.4	25.54	26.40
1109	99.8	109.4	25.54	26.39

【PUHY-P960SKM-E】

室内ユニット 合計容量	能力 (kW)		入力 (kW)	
	冷房	暖房	冷房	暖房
1110	99.9	109.5	25.55	26.39
1111	99.9	109.5	25.55	26.38
1112	99.9	109.5	25.55	26.37
1113	99.9	109.5	25.55	26.37
1114	100.0	109.5	25.55	26.36
1115	100.0	109.5	25.55	26.35
1116	100.0	109.5	25.56	26.34
1117	100.0	109.5	25.56	26.34
1118	100.1	109.5	25.56	26.33
1119	100.1	109.5	25.56	26.32
1120	100.1	109.6	25.56	26.31
1121	100.1	109.6	25.57	26.31
1122	100.2	109.6	25.57	26.30
1123	100.2	109.6	25.57	26.29
1124	100.2	109.6	25.57	26.29
1125	100.2	109.6	25.57	26.28
1126	100.3	109.6	25.57	26.27
1127	100.3	109.6	25.58	26.26
1128	100.3	109.6	25.58	26.26
1129	100.3	109.6	25.58	26.25
1130	100.4	109.7	25.58	26.24
1131	100.4	109.7	25.58	26.24
1132	100.4	109.7	25.58	26.23
1133	100.4	109.7	25.59	26.22
1134	100.5	109.7	25.59	26.21
1135	100.5	109.7	25.59	26.21
1136	100.5	109.7	25.59	26.20
1137	100.5	109.7	25.59	26.19
1138	100.6	109.7	25.60	26.18
1139	100.6	109.7	25.60	26.18
1140	100.6	109.8	25.60	26.17
1141	100.7	109.8	25.60	26.16
1142	100.7	109.8	25.60	26.16
1143	100.7	109.8	25.60	26.15
1144	100.7	109.8	25.61	26.14
1145	100.8	109.8	25.61	26.13
1146	100.8	109.8	25.61	26.13
1147	100.8	109.8	25.61	26.12
1148	100.8	109.8	25.61	26.11
1149	100.9	109.8	25.61	26.11
1150	100.9	109.8	25.62	26.10
1151	100.9	109.9	25.62	26.09
1152	100.9	109.9	25.62	26.08
1153	101.0	109.9	25.62	26.08
1154	101.0	109.9	25.62	26.07
1155	101.0	109.9	25.63	26.06
1156	101.0	109.9	25.63	26.05
1157	101.1	109.9	25.63	26.05
1158	101.1	109.9	25.63	26.04
1159	101.1	109.9	25.63	26.03
1160	101.1	109.9	25.63	26.03
1161	101.2	110.0	25.64	26.02
1162	101.2	110.0	25.64	26.01
1163	101.2	110.0	25.64	26.00
1164	101.2	110.0	25.64	26.00
1165	101.3	110.0	25.64	25.99
1166	101.3	110.0	25.64	25.98
1167	101.3	110.0	25.65	25.98
1168	101.3	110.0	25.65	25.97
1169	101.4	110.0	25.65	25.96
1170	101.4	110.0	25.65	25.95
1171	101.4	110.1	25.65	25.95
1172	101.4	110.1	25.66	25.94
1173	101.5	110.1	25.66	25.93
1174	101.5	110.1	25.66	25.92
1175	101.5	110.1	25.66	25.92
1176	101.6	110.1	25.66	25.91
1177	101.6	110.1	25.66	25.90
1178	101.6	110.1	25.67	25.90
1179	101.6	110.1	25.67	25.89

室内ユニット 合計容量	能力 (kW)		入力 (kW)	
	冷房	暖房	冷房	暖房
1180	101.7	110.1	25.67	25.88
1181	101.7	110.1	25.67	25.87
1182	101.7	110.2	25.67	25.87
1183	101.7	110.2	25.67	25.86
1184	101.8	110.2	25.68	25.85
1185	101.8	110.2	25.68	25.85
1186	101.8	110.2	25.68	25.84
1187	101.8	110.2	25.68	25.83
1188	101.9	110.2	25.68	25.82
1189	101.9	110.2	25.69	25.82
1190	101.9	110.2	25.69	25.81
1191	101.9	110.2	25.69	25.80
1192	102.0	110.3	25.69	25.79
1193	102.0	110.3	25.69	25.79
1194	102.0	110.3	25.69	25.78
1195	102.0	110.3	25.70	25.77
1196	102.1	110.3	25.70	25.77
1197	102.1	110.3	25.70	25.76
1198	102.1	110.3	25.70	25.75
1199	102.1	110.3	25.70	25.74
1200	102.2	110.3	25.71	25.74
1201	102.2	110.3	25.71	25.73
1202	102.2	110.4	25.71	25.72
1203	102.2	110.4	25.71	25.72
1204	102.3	110.4	25.71	25.71
1205	102.3	110.4	25.71	25.70
1206	102.3	110.4	25.72	25.69
1207	102.3	110.4	25.72	25.69
1208	102.4	110.4	25.72	25.68
1209	102.4	110.4	25.72	25.67
1210	102.4	110.4	25.72	25.66
1211	102.4	110.4	25.72	25.66
1212	102.5	110.5	25.73	25.65
1213	102.5	110.5	25.73	25.64
1214	102.5	110.5	25.73	25.64
1215	102.6	110.5	25.73	25.63
1216	102.6	110.5	25.73	25.62
1217	102.6	110.5	25.74	25.61
1218	102.6	110.5	25.74	25.61
1219	102.7	110.5	25.74	25.60
1220	102.7	110.5	25.74	25.59
1221	102.7	110.5	25.74	25.59
1222	102.7	110.5	25.74	25.58
1223	102.8	110.6	25.75	25.57
1224	102.8	110.6	25.75	25.56
1225	102.8	110.6	25.75	25.56
1226	102.8	110.6	25.75	25.55
1227	102.9	110.6	25.75	25.54
1228	102.9	110.6	25.75	25.53
1229	102.9	110.6	25.76	25.53
1230	102.9	110.6	25.76	25.52
1231	103.0	110.6	25.76	25.51
1232	103.0	110.6	25.76	25.51
1233	103.0	110.7	25.76	25.50
1234	103.0	110.7	25.77	25.49
1235	103.1	110.7	25.77	25.48
1236	103.1	110.7	25.77	25.48
1237	103.1	110.7	25.77	25.47
1238	103.1	110.7	25.77	25.46
1239	103.2	110.7	25.77	25.46
1240	103.2	110.7	25.78	25.45
1241	103.2	110.7	25.78	25.44
1242	103.2	110.7	25.78	25.43
1243	103.3	110.8	25.78	25.43
1244	103.3	110.8	25.78	25.42
1245	103.3	110.8	25.78	25.41
1246	103.3	110.8	25.79	25.40
1247	103.4	110.8	25.79	25.40
1248	103.4	110.8	25.79	25.39

### 【PUHY-P1010SKM-E】

室内ユニット 合計容量	能力 (kW)		入力 (kW)	
	冷房	暖房	冷房	暖房
505	50.5	56.5	15.04	16.44
506	50.6	56.6	15.07	16.47
507	50.7	56.7	15.11	16.51
508	50.8	56.8	15.15	16.55
509	50.9	56.9	15.18	16.59
510	51.0	57.1	15.22	16.62
511	51.1	57.2	15.26	16.66
512	51.2	57.3	15.29	16.70
513	51.3	57.4	15.33	16.74
514	51.4	57.5	15.36	16.77
515	51.5	57.6	15.40	16.81
516	51.6	57.7	15.44	16.85
517	51.7	57.8	15.47	16.88
518	51.8	58.0	15.51	16.92
519	51.9	58.1	15.54	16.96
520	52.0	58.2	15.58	16.99
521	52.1	58.3	15.61	17.03
522	52.2	58.4	15.65	17.07
523	52.3	58.5	15.68	17.10
524	52.4	58.6	15.72	17.14
525	52.5	58.7	15.76	17.18
526	52.6	58.8	15.79	17.21
527	52.7	59.0	15.83	17.25
528	52.8	59.1	15.86	17.28
529	52.9	59.2	15.90	17.32
530	53.0	59.3	15.93	17.36
531	53.1	59.4	15.97	17.39
532	53.2	59.5	16.00	17.43
533	53.3	59.6	16.04	17.47
534	53.4	59.7	16.07	17.50
535	53.5	59.9	16.11	17.54
536	53.6	60.0	16.14	17.57
537	53.7	60.1	16.18	17.61
538	53.8	60.2	16.21	17.65
539	53.9	60.3	16.25	17.68
540	54.0	60.4	16.28	17.72
541	54.1	60.5	16.32	17.75
542	54.2	60.6	16.35	17.79
543	54.3	60.8	16.38	17.82
544	54.4	60.9	16.42	17.86
545	54.5	61.0	16.45	17.89
546	54.6	61.1	16.49	17.93
547	54.7	61.2	16.52	17.97
548	54.8	61.3	16.56	18.00
549	54.9	61.4	16.59	18.04
550	55.0	61.5	16.62	18.07
551	55.1	61.6	16.66	18.11
552	55.2	61.8	16.69	18.14
553	55.3	61.9	16.73	18.18
554	55.4	62.0	16.76	18.21
555	55.5	62.1	16.79	18.25
556	55.6	62.2	16.83	18.28
557	55.7	62.3	16.86	18.32
558	55.8	62.4	16.89	18.35
559	55.9	62.5	16.93	18.39
560	56.0	62.7	16.96	18.42
561	56.1	62.8	17.00	18.46
562	56.2	62.9	17.03	18.49
563	56.3	63.0	17.06	18.52
564	56.4	63.1	17.10	18.56
565	56.5	63.2	17.13	18.59
566	56.6	63.3	17.16	18.63
567	56.7	63.4	17.20	18.66
568	56.8	63.5	17.23	18.70
569	56.9	63.7	17.26	18.73
570	57.0	63.8	17.29	18.77
571	57.1	63.9	17.33	18.80
572	57.2	64.0	17.36	18.83
573	57.3	64.1	17.39	18.87
574	57.4	64.2	17.43	18.90

室内ユニット 合計容量	能力 (kW)		入力 (kW)	
	冷房	暖房	冷房	暖房
575	57.5	64.3	17.46	18.94
576	57.6	64.4	17.49	18.97
577	57.7	64.6	17.52	19.00
578	57.8	64.7	17.56	19.04
579	57.9	64.8	17.59	19.07
580	58.0	64.9	17.62	19.11
581	58.1	65.0	17.65	19.14
582	58.2	65.1	17.69	19.17
583	58.3	65.2	17.72	19.21
584	58.4	65.3	17.75	19.24
585	58.5	65.5	17.78	19.27
586	58.6	65.6	17.82	19.31
587	58.7	65.7	17.85	19.34
588	58.8	65.8	17.88	19.37
589	58.9	65.9	17.91	19.41
590	59.0	66.0	17.94	19.44
591	59.1	66.1	17.98	19.47
592	59.2	66.2	18.01	19.51
593	59.3	66.3	18.04	19.54
594	59.4	66.5	18.07	19.57
595	59.5	66.6	18.10	19.61
596	59.6	66.7	18.13	19.64
597	59.7	66.8	18.17	19.67
598	59.8	66.9	18.20	19.70
599	59.9	67.0	18.23	19.74
600	60.0	67.1	18.26	19.77
601	60.1	67.2	18.29	19.80
602	60.2	67.4	18.32	19.84
603	60.3	67.5	18.35	19.87
604	60.4	67.6	18.39	19.90
605	60.5	67.7	18.42	19.93
606	60.6	67.8	18.45	19.97
607	60.7	67.9	18.48	20.00
608	60.8	68.0	18.51	20.03
609	60.9	68.1	18.54	20.06
610	61.0	68.2	18.57	20.10
611	61.1	68.4	18.60	20.13
612	61.2	68.5	18.63	20.16
613	61.3	68.6	18.66	20.19
614	61.4	68.7	18.70	20.22
615	61.5	68.8	18.73	20.26
616	61.6	68.9	18.76	20.29
617	61.7	69.0	18.79	20.32
618	61.8	69.1	18.82	20.35
619	61.9	69.3	18.85	20.38
620	62.0	69.4	18.88	20.42
621	62.1	69.5	18.91	20.45
622	62.2	69.6	18.94	20.48
623	62.3	69.7	18.97	20.51
624	62.4	69.8	19.00	20.54
625	62.5	69.9	19.03	20.57
626	62.6	70.0	19.06	20.61
627	62.7	70.1	19.09	20.64
628	62.8	70.3	19.12	20.67
629	62.9	70.4	19.15	20.70
630	63.0	70.5	19.18	20.73
631	63.1	70.6	19.21	20.76
632	63.2	70.7	19.24	20.79
633	63.3	70.8	19.27	20.82
634	63.4	70.9	19.30	20.86
635	63.5	71.0	19.33	20.89
636	63.6	71.2	19.36	20.92
637	63.7	71.3	19.39	20.95
638	63.8	71.4	19.42	20.98
639	63.9	71.5	19.45	21.01
640	64.0	71.6	19.48	21.04
641	64.1	71.7	19.51	21.07
642	64.2	71.8	19.53	21.10
643	64.3	71.9	19.56	21.13
644	64.4	72.1	19.59	21.16

室内ユニット 合計容量	能力 (kW)		入力 (kW)	
	冷房	暖房	冷房	暖房
645	64.5	72.2	19.62	21.20
646	64.6	72.3	19.65	21.23
647	64.7	72.4	19.68	21.26
648	64.8	72.5	19.71	21.29
649	64.9	72.6	19.74	21.32
650	65.0	72.7	19.77	21.35
651	65.1	72.8	19.80	21.38
652	65.2	72.9	19.82	21.41
653	65.3	73.1	19.85	21.44
654	65.4	73.2	19.88	21.47
655	65.5	73.3	19.91	21.50
656	65.6	73.4	19.94	21.53
657	65.7	73.5	19.97	21.56
658	65.8	73.6	19.99	21.59
659	65.9	73.7	20.02	21.62
660	66.0	73.8	20.05	21.65
661	66.1	74.0	20.08	21.68
662	66.2	74.1	20.11	21.71
663	66.3	74.2	20.14	21.74
664	66.4	74.3	20.16	21.77
665	66.5	74.4	20.19	21.80
666	66.6	74.5	20.22	21.83
667	66.7	74.6	20.25	21.86
668	66.8	74.7	20.28	21.89
669	66.9	74.8	20.30	21.91
670	67.0	75.0	20.33	21.94
671	67.1	75.1	20.36	21.97
672	67.2	75.2	20.39	22.00
673	67.3	75.3	20.41	22.03
674	67.4	75.4	20.44	22.06
675	67.5	75.5	20.47	22.09
676	67.6	75.6	20.50	22.12
677	67.7	75.7	20.52	22.15
678	67.8	75.9	20.55	22.18
679	67.9	76.0	20.58	22.21
680	68.0	76.1	20.61	22.24
681	68.1	76.2	20.63	22.26
682	68.2	76.3	20.66	22.29
683	68.3	76.4	20.69	22.32
684	68.4	76.5	20.71	22.35
685	68.5	76.6	20.74	22.38
686	68.6	76.8	20.77	22.41
687	68.7	76.9	20.80	22.44
688	68.8	77.0	20.82	22.46
689	68.9	77.1	20.85	22.49
690	69.0	77.2	20.88	22.52
691	69.1	77.3	20.90	22.55
692	69.2	77.4	20.93	22.58
693	69.3	77.5	20.96	22.61
694	69.4	77.6	20.98	22.63
695	69.5	77.8	21.01	22.66
696	69.6	77.9	21.04	22.69
697	69.7	78.0	21.06	22.72
698	69.8	78.1	21.09	22.75
699	69.9	78.2	21.11	22.77
700	70.0	78.3	21.14	22.80
701	70.1	78.4	21.17	22.83
702	70.2	78.5	21.19	22.86
703	70.3	78.7	21.22	22.89
704	70.4	78.8	21.24	22.91
705	70.5	78.9	21.27	22.94
706	70.6	79.0	21.30	22.97
707	70.7	79.1	21.32	23.00
708	70.8	79.2	21.35	23.02
709	70.9	79.3	21.37	23.05
710	71.0	79.4	21.40	23.08
711	71.1	79.5	21.42	23.11
712	71.2	79.7	21.45	23.13
713	71.3	79.8	21.48	23.16
714	71.4	79.9	21.50	23.19

【PUHY-P1010SKM-E】

室内ユニット 合計容量	能力 (kW)		入力 (kW)	
	冷房	暖房	冷房	暖房
715	71.5	80.0	21.53	23.22
716	71.6	80.1	21.55	23.24
717	71.7	80.2	21.58	23.27
718	71.8	80.3	21.60	23.30
719	71.9	80.4	21.63	23.32
720	72.0	80.6	21.65	23.35
721	72.1	80.7	21.68	23.38
722	72.2	80.8	21.70	23.40
723	72.3	80.9	21.73	23.43
724	72.4	81.0	21.75	23.46
725	72.5	81.1	21.78	23.48
726	72.6	81.2	21.80	23.51
727	72.7	81.3	21.83	23.54
728	72.8	81.4	21.85	23.56
729	72.9	81.6	21.88	23.59
730	73.0	81.7	21.90	23.62
731	73.1	81.8	21.93	23.64
732	73.2	81.9	21.95	23.67
733	73.3	82.0	21.97	23.70
734	73.4	82.1	22.00	23.72
735	73.5	82.2	22.02	23.75
736	73.6	82.3	22.05	23.78
737	73.7	82.5	22.07	23.80
738	73.8	82.6	22.10	23.83
739	73.9	82.7	22.12	23.85
740	74.0	82.8	22.14	23.88
741	74.1	82.9	22.17	23.91
742	74.2	83.0	22.19	23.93
743	74.3	83.1	22.22	23.96
744	74.4	83.2	22.24	23.98
745	74.5	83.4	22.26	24.01
746	74.6	83.5	22.29	24.03
747	74.7	83.6	22.31	24.06
748	74.8	83.7	22.34	24.09
749	74.9	83.8	22.36	24.11
750	75.0	83.9	22.38	24.14
751	75.1	84.0	22.41	24.16
752	75.2	84.1	22.43	24.19
753	75.3	84.2	22.45	24.21
754	75.4	84.4	22.48	24.24
755	75.5	84.5	22.50	24.26
756	75.6	84.6	22.52	24.29
757	75.7	84.7	22.55	24.31
758	75.8	84.8	22.57	24.34
759	75.9	84.9	22.59	24.36
760	76.0	85.0	22.62	24.39
761	76.1	85.1	22.64	24.41
762	76.2	85.3	22.66	24.44
763	76.3	85.4	22.68	24.46
764	76.4	85.5	22.71	24.49
765	76.5	85.6	22.73	24.51
766	76.6	85.7	22.75	24.54
767	76.7	85.8	22.77	24.56
768	76.8	85.9	22.80	24.59
769	76.9	86.0	22.82	24.61
770	77.0	86.1	22.84	24.64
771	77.1	86.3	22.87	24.66
772	77.2	86.4	22.89	24.68
773	77.3	86.5	22.91	24.71
774	77.4	86.6	22.93	24.73
775	77.5	86.7	22.95	24.76
776	77.6	86.8	22.98	24.78
777	77.7	86.9	23.00	24.81
778	77.8	87.0	23.02	24.83
779	77.9	87.2	23.04	24.85
780	78.0	87.3	23.06	24.88
781	78.1	87.4	23.09	24.90
782	78.2	87.5	23.11	24.93
783	78.3	87.6	23.13	24.95
784	78.4	87.7	23.15	24.97

室内ユニット 合計容量	能力 (kW)		入力 (kW)	
	冷房	暖房	冷房	暖房
785	78.5	87.8	23.17	25.00
786	78.6	87.9	23.20	25.02
787	78.7	88.1	23.22	25.04
788	78.8	88.2	23.24	25.07
789	78.9	88.3	23.26	25.09
790	79.0	88.4	23.28	25.12
791	79.1	88.5	23.30	25.14
792	79.2	88.6	23.32	25.16
793	79.3	88.7	23.35	25.19
794	79.4	88.8	23.37	25.21
795	79.5	88.9	23.39	25.23
796	79.6	89.1	23.41	25.26
797	79.7	89.2	23.43	25.28
798	79.8	89.3	23.45	25.30
799	79.9	89.4	23.47	25.32
800	80.0	89.5	23.49	25.35
801	80.1	89.6	23.51	25.37
802	80.2	89.7	23.53	25.39
803	80.3	89.8	23.56	25.42
804	80.4	90.0	23.58	25.44
805	80.5	90.1	23.60	25.46
806	80.6	90.2	23.62	25.48
807	80.7	90.3	23.64	25.51
808	80.8	90.4	23.66	25.53
809	80.9	90.5	23.68	25.55
810	81.0	90.6	23.70	25.58
811	81.1	90.7	23.72	25.60
812	81.2	90.8	23.74	25.62
813	81.3	91.0	23.76	25.64
814	81.4	91.1	23.78	25.67
815	81.5	91.2	23.80	25.69
816	81.6	91.3	23.82	25.71
817	81.7	91.4	23.84	25.73
818	81.8	91.5	23.86	25.75
819	81.9	91.6	23.88	25.78
820	82.0	91.7	23.90	25.80
821	82.1	91.9	23.92	25.82
822	82.2	92.0	23.94	25.84
823	82.3	92.1	23.96	25.86
824	82.4	92.2	23.98	25.89
825	82.5	92.3	24.00	25.91
826	82.6	92.4	24.02	25.93
827	82.7	92.5	24.04	25.95
828	82.8	92.6	24.06	25.97
829	82.9	92.7	24.08	25.99
830	83.0	92.9	24.10	26.02
831	83.1	93.0	24.12	26.04
832	83.2	93.1	24.13	26.06
833	83.3	93.2	24.15	26.08
834	83.4	93.3	24.17	26.10
835	83.5	93.4	24.19	26.12
836	83.6	93.5	24.21	26.14
837	83.7	93.6	24.23	26.17
838	83.8	93.8	24.25	26.19
839	83.9	93.9	24.27	26.21
840	84.0	94.0	24.29	26.23
841	84.1	94.1	24.31	26.25
842	84.2	94.2	24.32	26.27
843	84.3	94.3	24.34	26.29
844	84.4	94.4	24.36	26.31
845	84.5	94.5	24.38	26.33
846	84.6	94.7	24.40	26.35
847	84.7	94.8	24.42	26.38
848	84.8	94.9	24.44	26.40
849	84.9	95.0	24.45	26.42
850	85.0	95.1	24.47	26.44
851	85.1	95.2	24.49	26.46
852	85.2	95.3	24.51	26.48
853	85.3	95.4	24.53	26.50
854	85.4	95.5	24.54	26.52

室内ユニット 合計容量	能力 (kW)		入力 (kW)	
	冷房	暖房	冷房	暖房
855	85.5	95.7	24.56	26.54
856	85.6	95.8	24.58	26.56
857	85.7	95.9	24.60	26.58
858	85.8	96.0	24.62	26.60
859	85.9	96.1	24.63	26.62
860	86.0	96.2	24.65	26.64
861	86.1	96.3	24.67	26.66
862	86.2	96.4	24.69	26.68
863	86.3	96.6	24.71	26.70
864	86.4	96.7	24.72	26.72
865	86.5	96.8	24.74	26.74
866	86.6	96.9	24.76	26.76
867	86.7	97.0	24.78	26.78
868	86.8	97.1	24.79	26.80
869	86.9	97.2	24.81	26.82
870	87.0	97.3	24.83	26.84
871	87.1	97.4	24.84	26.86
872	87.2	97.6	24.86	26.88
873	87.3	97.7	24.88	26.90
874	87.4	97.8	24.90	26.92
875	87.5	97.9	24.91	26.94
876	87.6	98.0	24.93	26.96
877	87.7	98.1	24.95	26.98
878	87.8	98.2	24.96	26.99
879	87.9	98.3	24.98	27.01
880	88.0	98.5	25.00	27.03
881	88.1	98.6	25.01	27.05
882	88.2	98.7	25.03	27.07
883	88.3	98.8	25.05	27.09
884	88.4	98.9	25.06	27.11
885	88.5	99.0	25.08	27.13
886	88.6	99.1	25.10	27.15
887	88.7	99.2	25.11	27.17
888	88.8	99.4	25.13	27.18
889	88.9	99.5	25.14	27.20
890	89.0	99.6	25.16	27.22
891	89.1	99.7	25.18	27.24
892	89.2	99.8	25.19	27.26
893	89.3	99.9	25.21	27.28
894	89.4	100.0	25.23	27.30
895	89.5	100.1	25.24	27.31
896	89.6	100.2	25.26	27.33
897	89.7	100.4	25.27	27.35
898	89.8	100.5	25.29	27.37
899	89.9	100.6	25.30	27.39
900	90.0	100.7	25.32	27.41
901	90.1	100.8	25.34	27.42
902	90.2	100.9	25.35	27.44
903	90.3	101.0	25.37	27.46
904	90.4	101.1	25.38	27.48
905	90.5	101.3	25.40	27.50
906	90.6	101.4	25.41	27.51
907	90.7	101.5	25.43	27.53
908	90.8	101.6	25.44	27.55
909	90.9	101.7	25.46	27.57
910	91.0	101.8	25.47	27.58
911	91.1	101.9	25.49	27.60
912	91.2	102.0	25.50	27.62
913	91.3	102.1	25.52	27.64
914	91.4	102.3	25.53	27.65
915	91.5	102.4	25.55	27.67
916	91.6	102.5	25.56	27.69
917	91.7	102.6	25.58	27.71
918	91.8	102.7	25.59	27.72
919	91.9	102.8	25.61	27.74
920	92.0	102.9	25.62	27.76
921	92.1	103.0	25.64	27.78
922	92.2	103.2	25.65	27.79
923	92.3	103.3	25.67	27.81
924	92.4	103.4	25.68	27.83

**【PUHY-P1010SKM-E】**

室内ユニット 合計容量	能力 (kW)		入力 (kW)	
	冷房	暖房	冷房	暖房
925	92.5	103.5	25.69	27.84
926	92.6	103.6	25.71	27.86
927	92.7	103.7	25.72	27.88
928	92.8	103.8	25.74	27.89
929	92.9	103.9	25.75	27.91
930	93.0	104.0	25.77	27.93
931	93.1	104.2	25.78	27.94
932	93.2	104.3	25.79	27.96
933	93.3	104.4	25.81	27.98
934	93.4	104.5	25.82	27.99
935	93.5	104.6	25.83	28.01
936	93.6	104.7	25.85	28.03
937	93.7	104.8	25.86	28.04
938	93.8	104.9	25.88	28.06
939	93.9	105.1	25.89	28.08
940	94.0	105.2	25.90	28.09
941	94.1	105.3	25.92	28.11
942	94.2	105.4	25.93	28.12
943	94.3	105.5	25.94	28.14
944	94.4	105.6	25.96	28.16
945	94.5	105.7	25.97	28.17
946	94.6	105.8	25.98	28.19
947	94.7	106.0	26.00	28.20
948	94.8	106.1	26.01	28.22
949	94.9	106.2	26.02	28.24
950	95.0	106.3	26.04	28.25
951	95.1	106.4	26.05	28.27
952	95.2	106.5	26.06	28.28
953	95.3	106.6	26.07	28.30
954	95.4	106.7	26.09	28.31
955	95.5	106.8	26.10	28.33
956	95.6	107.0	26.11	28.34
957	95.7	107.1	26.13	28.36
958	95.8	107.2	26.14	28.38
959	95.9	107.3	26.15	28.39
960	96.0	107.4	26.16	28.41
961	96.1	107.5	26.18	28.42
962	96.2	107.6	26.19	28.44
963	96.3	107.7	26.20	28.45
964	96.4	107.9	26.21	28.47
965	96.5	108.0	26.22	28.48
966	96.6	108.1	26.24	28.50
967	96.7	108.2	26.25	28.51
968	96.8	108.3	26.26	28.53
969	96.9	108.4	26.27	28.54
970	97.0	108.5	26.29	28.56
971	97.1	108.6	26.30	28.57
972	97.2	108.7	26.31	28.58
973	97.3	108.9	26.32	28.60
974	97.4	109.0	26.33	28.61
975	97.5	109.1	26.34	28.63
976	97.6	109.2	26.36	28.64
977	97.7	109.3	26.37	28.66
978	97.8	109.4	26.38	28.67
979	97.9	109.5	26.39	28.69
980	98.0	109.6	26.40	28.70
981	98.1	109.8	26.41	28.71
982	98.2	109.9	26.42	28.73
983	98.3	110.0	26.44	28.74
984	98.4	110.1	26.45	28.76
985	98.5	110.2	26.46	28.77
986	98.6	110.3	26.47	28.78
987	98.7	110.4	26.48	28.80
988	98.8	110.5	26.49	28.81
989	98.9	110.7	26.50	28.83
990	99.0	110.8	26.51	28.84
991	99.1	110.9	26.52	28.85
992	99.2	111.0	26.54	28.87
993	99.3	111.1	26.55	28.88
994	99.4	111.2	26.56	28.89

室内ユニット 合計容量	能力 (kW)		入力 (kW)	
	冷房	暖房	冷房	暖房
995	99.5	111.3	26.57	28.91
996	99.6	111.4	26.58	28.92
997	99.7	111.5	26.59	28.94
998	99.8	111.7	26.60	28.95
999	99.9	111.8	26.61	28.96
1000	100.0	111.9	26.62	28.98
1001	100.1	112.0	26.63	28.99
1002	100.2	112.1	26.64	29.00
1003	100.3	112.2	26.65	29.01
1004	100.4	112.3	26.66	29.03
1005	100.5	112.4	26.67	29.04
1006	100.6	112.6	26.68	29.05
1007	100.7	112.7	26.69	29.07
1008	100.8	112.8	26.70	29.08
1009	100.9	112.9	26.71	29.09
1010	101.0	113.0	26.71	29.10
1011	101.0	113.0	26.71	29.10
1012	101.1	113.0	26.71	29.09
1013	101.1	113.0	26.71	29.08
1014	101.1	113.0	26.71	29.07
1015	101.1	113.1	26.72	29.06
1016	101.2	113.1	26.72	29.06
1017	101.2	113.1	26.72	29.05
1018	101.2	113.1	26.72	29.04
1019	101.2	113.1	26.72	29.03
1020	101.3	113.1	26.72	29.02
1021	101.3	113.1	26.72	29.02
1022	101.3	113.1	26.73	29.01
1023	101.3	113.1	26.73	29.00
1024	101.4	113.1	26.73	28.99
1025	101.4	113.2	26.73	28.99
1026	101.4	113.2	26.73	28.98
1027	101.4	113.2	26.73	28.97
1028	101.5	113.2	26.74	28.96
1029	101.5	113.2	26.74	28.95
1030	101.5	113.2	26.74	28.95
1031	101.5	113.2	26.74	28.94
1032	101.6	113.2	26.74	28.93
1033	101.6	113.2	26.74	28.92
1034	101.6	113.2	26.74	28.91
1035	101.6	113.3	26.75	28.91
1036	101.7	113.3	26.75	28.90
1037	101.7	113.3	26.75	28.89
1038	101.7	113.3	26.75	28.88
1039	101.7	113.3	26.75	28.88
1040	101.8	113.3	26.75	28.87
1041	101.8	113.3	26.75	28.86
1042	101.8	113.3	26.76	28.85
1043	101.8	113.3	26.76	28.84
1044	101.9	113.3	26.76	28.84
1045	101.9	113.4	26.76	28.83
1046	101.9	113.4	26.76	28.82
1047	101.9	113.4	26.76	28.81
1048	102.0	113.4	26.76	28.80
1049	102.0	113.4	26.77	28.80
1050	102.0	113.4	26.77	28.79
1051	102.0	113.4	26.77	28.78
1052	102.1	113.4	26.77	28.77
1053	102.1	113.4	26.77	28.76
1054	102.1	113.5	26.77	28.76
1055	102.1	113.5	26.78	28.75
1056	102.2	113.5	26.78	28.74
1057	102.2	113.5	26.78	28.73
1058	102.2	113.5	26.78	28.73
1059	102.2	113.5	26.78	28.72
1060	102.3	113.5	26.78	28.71
1061	102.3	113.5	26.78	28.70
1062	102.3	113.5	26.79	28.69
1063	102.3	113.5	26.79	28.69
1064	102.4	113.6	26.79	28.68

室内ユニット 合計容量	能力 (kW)		入力 (kW)	
	冷房	暖房	冷房	暖房
1065	102.4	113.6	26.79	28.67
1066	102.4	113.6	26.79	28.66
1067	102.4	113.6	26.79	28.65
1068	102.5	113.6	26.79	28.65
1069	102.5	113.6	26.80	28.64
1070	102.5	113.6	26.80	28.63
1071	102.5	113.6	26.80	28.62
1072	102.6	113.6	26.80	28.62
1073	102.6	113.6	26.80	28.61
1074	102.6	113.7	26.80	28.60
1075	102.6	113.7	26.80	28.59
1076	102.7	113.7	26.81	28.58
1077	102.7	113.7	26.81	28.58
1078	102.7	113.7	26.81	28.57
1079	102.7	113.7	26.81	28.56
1080	102.8	113.7	26.81	28.55
1081	102.8	113.7	26.81	28.54
1082	102.8	113.7	26.81	28.54
1083	102.8	113.7	26.82	28.53
1084	102.9	113.8	26.82	28.52
1085	102.9	113.8	26.82	28.51
1086	102.9	113.8	26.82	28.51
1087	102.9	113.8	26.82	28.50
1088	103.0	113.8	26.82	28.49
1089	103.0	113.8	26.83	28.48
1090	103.0	113.8	26.83	28.47
1091	103.0	113.8	26.83	28.47
1092	103.1	113.8	26.83	28.46
1093	103.1	113.8	26.83	28.45
1094	103.1	113.9	26.83	28.44
1095	103.1	113.9	26.83	28.43
1096	103.2	113.9	26.84	28.43
1097	103.2	113.9	26.84	28.42
1098	103.2	113.9	26.84	28.41
1099	103.2	113.9	26.84	28.40
1100	103.3	113.9	26.84	28.40
1101	103.3	113.9	26.84	28.39
1102	103.3	113.9	26.84	28.38
1103	103.3	114.0	26.85	28.37
1104	103.4	114.0	26.85	28.36
1105	103.4	114.0	26.85	28.36
1106	103.4	114.0	26.85	28.35
1107	103.4	114.0	26.85	28.34
1108	103.5	114.0	26.85	28.33
1109	103.5	114.0	26.85	28.32
1110	103.5	114.0	26.86	28.32
1111	103.5	114.0	26.86	28.31
1112	103.6	114.0	26.86	28.30
1113	103.6	114.1	26.86	28.29
1114	103.6	114.1	26.86	28.29
1115	103.6	114.1	26.86	28.28
1116	103.7	114.1	26.86	28.27
1117	103.7	114.1	26.87	28.26
1118	103.7	114.1	26.87	28.25
1119	103.7	114.1	26.87	28.25
1120	103.8	114.1	26.87	28.24
1121	103.8	114.1	26.87	28.23
1122	103.8	114.1	26.87	28.22
1123	103.8	114.2	26.88	28.21
1124	103.9	114.2	26.88	28.21
1125	103.9	114.2	26.88	28.20
1126	103.9	114.2	26.88	28.19
1127	103.9	114.2	26.88	28.18
1128	104.0	114.2	26.88	28.17
1129	104.0	114.2	26.88	28.17
1130	104.0	114.2	26.89	28.16
1131	104.0	114.2	26.89	28.15
1132	104.1	114.2	26.89	28.14
1133	104.1	114.3	26.89	28.14
1134	104.1	114.3	26.89	28.13



## 【PUHY-P1010SKM-E】

室内ユニット 合計容量	能力 (kW)		入力 (kW)	
	冷房	暖房	冷房	暖房
1135	104.1	114.3	26.89	28.12
1136	104.2	114.3	26.89	28.11
1137	104.2	114.3	26.90	28.10
1138	104.2	114.3	26.90	28.10
1139	104.2	114.3	26.90	28.09
1140	104.3	114.3	26.90	28.08
1141	104.3	114.3	26.90	28.07
1142	104.3	114.4	26.90	28.06
1143	104.3	114.4	26.90	28.06
1144	104.4	114.4	26.91	28.05
1145	104.4	114.4	26.91	28.04
1146	104.4	114.4	26.91	28.03
1147	104.4	114.4	26.91	28.03
1148	104.5	114.4	26.91	28.02
1149	104.5	114.4	26.91	28.01
1150	104.5	114.4	26.92	28.00
1151	104.5	114.4	26.92	27.99
1152	104.6	114.5	26.92	27.99
1153	104.6	114.5	26.92	27.98
1154	104.6	114.5	26.92	27.97
1155	104.6	114.5	26.92	27.96
1156	104.7	114.5	26.92	27.95
1157	104.7	114.5	26.93	27.95
1158	104.7	114.5	26.93	27.94
1159	104.7	114.5	26.93	27.93
1160	104.8	114.5	26.93	27.92
1161	104.8	114.5	26.93	27.92
1162	104.8	114.6	26.93	27.91
1163	104.8	114.6	26.93	27.90
1164	104.9	114.6	26.94	27.89
1165	104.9	114.6	26.94	27.88
1166	104.9	114.6	26.94	27.88
1167	104.9	114.6	26.94	27.87
1168	105.0	114.6	26.94	27.86
1169	105.0	114.6	26.94	27.85
1170	105.0	114.6	26.94	27.84
1171	105.0	114.6	26.95	27.84
1172	105.1	114.7	26.95	27.83
1173	105.1	114.7	26.95	27.82
1174	105.1	114.7	26.95	27.81
1175	105.1	114.7	26.95	27.81
1176	105.2	114.7	26.95	27.80
1177	105.2	114.7	26.95	27.79
1178	105.2	114.7	26.96	27.78
1179	105.2	114.7	26.96	27.77
1180	105.3	114.7	26.96	27.77
1181	105.3	114.7	26.96	27.76
1182	105.3	114.8	26.96	27.75
1183	105.3	114.8	26.96	27.74
1184	105.4	114.8	26.97	27.73
1185	105.4	114.8	26.97	27.73
1186	105.4	114.8	26.97	27.72
1187	105.4	114.8	26.97	27.71
1188	105.5	114.8	26.97	27.70
1189	105.5	114.8	26.97	27.69
1190	105.5	114.8	26.97	27.69
1191	105.5	114.9	26.98	27.68
1192	105.6	114.9	26.98	27.67
1193	105.6	114.9	26.98	27.66
1194	105.6	114.9	26.98	27.66
1195	105.6	114.9	26.98	27.65
1196	105.7	114.9	26.98	27.64
1197	105.7	114.9	26.98	27.63
1198	105.7	114.9	26.99	27.62
1199	105.7	114.9	26.99	27.62
1200	105.8	114.9	26.99	27.61
1201	105.8	115.0	26.99	27.60
1202	105.8	115.0	26.99	27.59
1203	105.8	115.0	26.99	27.58
1204	105.9	115.0	26.99	27.58

室内ユニット 合計容量	能力 (kW)		入力 (kW)	
	冷房	暖房	冷房	暖房
1205	105.9	115.0	27.00	27.57
1206	105.9	115.0	27.00	27.56
1207	105.9	115.0	27.00	27.55
1208	106.0	115.0	27.00	27.55
1209	106.0	115.0	27.00	27.54
1210	106.0	115.0	27.00	27.53
1211	106.0	115.1	27.01	27.52
1212	106.1	115.1	27.01	27.51
1213	106.1	115.1	27.01	27.51
1214	106.1	115.1	27.01	27.50
1215	106.1	115.1	27.01	27.49
1216	106.2	115.1	27.01	27.48
1217	106.2	115.1	27.01	27.47
1218	106.2	115.1	27.02	27.47
1219	106.2	115.1	27.02	27.46
1220	106.3	115.1	27.02	27.45
1221	106.3	115.2	27.02	27.44
1222	106.3	115.2	27.02	27.44
1223	106.3	115.2	27.02	27.43
1224	106.4	115.2	27.02	27.42
1225	106.4	115.2	27.03	27.41
1226	106.4	115.2	27.03	27.40
1227	106.4	115.2	27.03	27.40
1228	106.5	115.2	27.03	27.39
1229	106.5	115.2	27.03	27.38
1230	106.5	115.3	27.03	27.37
1231	106.5	115.3	27.03	27.36
1232	106.6	115.3	27.04	27.36
1233	106.6	115.3	27.04	27.35
1234	106.6	115.3	27.04	27.34
1235	106.6	115.3	27.04	27.33
1236	106.7	115.3	27.04	27.33
1237	106.7	115.3	27.04	27.32
1238	106.7	115.3	27.04	27.31
1239	106.7	115.3	27.05	27.30
1240	106.8	115.4	27.05	27.29
1241	106.8	115.4	27.05	27.29
1242	106.8	115.4	27.05	27.28
1243	106.8	115.4	27.05	27.27
1244	106.9	115.4	27.05	27.26
1245	106.9	115.4	27.06	27.25
1246	106.9	115.4	27.06	27.25
1247	106.9	115.4	27.06	27.24
1248	107.0	115.4	27.06	27.23
1249	107.0	115.4	27.06	27.22
1250	107.0	115.5	27.06	27.22
1251	107.0	115.5	27.06	27.21
1252	107.1	115.5	27.07	27.20
1253	107.1	115.5	27.07	27.19
1254	107.1	115.5	27.07	27.18
1255	107.1	115.5	27.07	27.18
1256	107.2	115.5	27.07	27.17
1257	107.2	115.5	27.07	27.16
1258	107.2	115.5	27.07	27.15
1259	107.2	115.5	27.08	27.14
1260	107.3	115.6	27.08	27.14
1261	107.3	115.6	27.08	27.13
1262	107.3	115.6	27.08	27.12
1263	107.3	115.6	27.08	27.11
1264	107.4	115.6	27.08	27.10
1265	107.4	115.6	27.08	27.10
1266	107.4	115.6	27.09	27.09
1267	107.4	115.6	27.09	27.08
1268	107.5	115.6	27.09	27.07
1269	107.5	115.6	27.09	27.07
1270	107.5	115.7	27.09	27.06
1271	107.5	115.7	27.09	27.05
1272	107.6	115.7	27.09	27.04
1273	107.6	115.7	27.10	27.03
1274	107.6	115.7	27.10	27.03

室内ユニット 合計容量	能力 (kW)		入力 (kW)	
	冷房	暖房	冷房	暖房
1275	107.6	115.7	27.10	27.02
1276	107.7	115.7	27.10	27.01
1277	107.7	115.7	27.10	27.00
1278	107.7	115.7	27.10	26.99
1279	107.7	115.8	27.11	26.99
1280	107.8	115.8	27.11	26.98
1281	107.8	115.8	27.11	26.97
1282	107.8	115.8	27.11	26.96
1283	107.8	115.8	27.11	26.96
1284	107.9	115.8	27.11	26.95
1285	107.9	115.8	27.11	26.94
1286	107.9	115.8	27.12	26.93
1287	107.9	115.8	27.12	26.92
1288	108.0	115.8	27.12	26.92
1289	108.0	115.9	27.12	26.91
1290	108.0	115.9	27.12	26.90
1291	108.0	115.9	27.12	26.89
1292	108.1	115.9	27.12	26.88
1293	108.1	115.9	27.13	26.88
1294	108.1	115.9	27.13	26.87
1295	108.1	115.9	27.13	26.86
1296	108.2	115.9	27.13	26.85
1297	108.2	115.9	27.13	26.85
1298	108.2	115.9	27.13	26.84
1299	108.2	116.0	27.13	26.83
1300	108.3	116.0	27.14	26.82
1301	108.3	116.0	27.14	26.81
1302	108.3	116.0	27.14	26.81
1303	108.3	116.0	27.14	26.80
1304	108.4	116.0	27.14	26.79
1305	108.4	116.0	27.14	26.78
1306	108.4	116.0	27.15	26.77
1307	108.4	116.0	27.15	26.77
1308	108.5	116.0	27.15	26.76
1309	108.5	116.1	27.15	26.75
1310	108.5	116.1	27.15	26.74
1311	108.5	116.1	27.15	26.74
1312	108.6	116.1	27.15	26.73
1313	108.6	116.1	27.16	26.72

【PUHY-P1080SKM-E】

室内ユニット 合計容量	能力 (kW)		入力 (kW)	
	冷房	暖房	冷房	暖房
540	54.0	59.8	15.96	17.41
541	54.1	59.8	16.00	17.45
542	54.2	59.9	16.03	17.49
543	54.3	60.1	16.07	17.52
544	54.4	60.2	16.10	17.56
545	54.5	60.3	16.14	17.60
546	54.6	60.4	16.17	17.63
547	54.7	60.5	16.21	17.67
548	54.8	60.6	16.24	17.71
549	54.9	60.7	16.28	17.74
550	55.0	60.8	16.31	17.78
551	55.1	60.9	16.35	17.82
552	55.2	61.1	16.38	17.85
553	55.3	61.2	16.42	17.89
554	55.4	61.3	16.45	17.92
555	55.5	61.4	16.49	17.96
556	55.6	61.5	16.52	18.00
557	55.7	61.6	16.56	18.03
558	55.8	61.7	16.59	18.07
559	55.9	61.8	16.62	18.11
560	56.0	61.9	16.66	18.14
561	56.1	62.0	16.69	18.18
562	56.2	62.2	16.73	18.21
563	56.3	62.3	16.76	18.25
564	56.4	62.4	16.80	18.29
565	56.5	62.5	16.83	18.32
566	56.6	62.6	16.86	18.36
567	56.7	62.7	16.90	18.39
568	56.8	62.8	16.93	18.43
569	56.9	62.9	16.97	18.46
570	57.0	63.0	17.00	18.50
571	57.1	63.2	17.03	18.54
572	57.2	63.3	17.07	18.57
573	57.3	63.4	17.10	18.61
574	57.4	63.5	17.14	18.64
575	57.5	63.6	17.17	18.68
576	57.6	63.7	17.20	18.71
577	57.7	63.8	17.24	18.75
578	57.8	63.9	17.27	18.78
579	57.9	64.0	17.30	18.82
580	58.0	64.1	17.34	18.85
581	58.1	64.3	17.37	18.89
582	58.2	64.4	17.40	18.92
583	58.3	64.5	17.44	18.96
584	58.4	64.6	17.47	18.99
585	58.5	64.7	17.50	19.03
586	58.6	64.8	17.54	19.06
587	58.7	64.9	17.57	19.10
588	58.8	65.0	17.60	19.13
589	58.9	65.1	17.64	19.17
590	59.0	65.3	17.67	19.20
591	59.1	65.4	17.70	19.24
592	59.2	65.5	17.74	19.27
593	59.3	65.6	17.77	19.31
594	59.4	65.7	17.80	19.34
595	59.5	65.8	17.84	19.38
596	59.6	65.9	17.87	19.41
597	59.7	66.0	17.90	19.44
598	59.8	66.1	17.93	19.48
599	59.9	66.2	17.97	19.51
600	60.0	66.4	18.00	19.55
601	60.1	66.5	18.03	19.58
602	60.2	66.6	18.07	19.62
603	60.3	66.7	18.10	19.65
604	60.4	66.8	18.13	19.68
605	60.5	66.9	18.16	19.72
606	60.6	67.0	18.20	19.75
607	60.7	67.1	18.23	19.78
608	60.8	67.2	18.26	19.82
609	60.9	67.4	18.29	19.85

室内ユニット 合計容量	能力 (kW)		入力 (kW)	
	冷房	暖房	冷房	暖房
610	61.0	67.5	18.33	19.89
611	61.1	67.6	18.36	19.92
612	61.2	67.7	18.39	19.95
613	61.3	67.8	18.42	19.99
614	61.4	67.9	18.46	20.02
615	61.5	68.0	18.49	20.05
616	61.6	68.1	18.52	20.09
617	61.7	68.2	18.55	20.12
618	61.8	68.4	18.58	20.15
619	61.9	68.5	18.62	20.19
620	62.0	68.6	18.65	20.22
621	62.1	68.7	18.68	20.25
622	62.2	68.8	18.71	20.29
623	62.3	68.9	18.74	20.32
624	62.4	69.0	18.78	20.35
625	62.5	69.1	18.81	20.39
626	62.6	69.2	18.84	20.42
627	62.7	69.3	18.87	20.45
628	62.8	69.5	18.90	20.48
629	62.9	69.6	18.93	20.52
630	63.0	69.7	18.97	20.55
631	63.1	69.8	19.00	20.58
632	63.2	69.9	19.03	20.62
633	63.3	70.0	19.06	20.65
634	63.4	70.1	19.09	20.68
635	63.5	70.2	19.12	20.71
636	63.6	70.3	19.15	20.75
637	63.7	70.5	19.19	20.78
638	63.8	70.6	19.22	20.81
639	63.9	70.7	19.25	20.84
640	64.0	70.8	19.28	20.87
641	64.1	70.9	19.31	20.91
642	64.2	71.0	19.34	20.94
643	64.3	71.1	19.37	20.97
644	64.4	71.2	19.40	21.00
645	64.5	71.3	19.44	21.04
646	64.6	71.4	19.47	21.07
647	64.7	71.6	19.50	21.10
648	64.8	71.7	19.53	21.13
649	64.9	71.8	19.56	21.16
650	65.0	71.9	19.59	21.19
651	65.1	72.0	19.62	21.23
652	65.2	72.1	19.65	21.26
653	65.3	72.2	19.68	21.29
654	65.4	72.3	19.71	21.32
655	65.5	72.4	19.74	21.35
656	65.6	72.6	19.77	21.38
657	65.7	72.7	19.80	21.42
658	65.8	72.8	19.84	21.45
659	65.9	72.9	19.87	21.48
660	66.0	73.0	19.90	21.51
661	66.1	73.1	19.93	21.54
662	66.2	73.2	19.96	21.57
663	66.3	73.3	19.99	21.60
664	66.4	73.4	20.02	21.63
665	66.5	73.5	20.05	21.67
666	66.6	73.7	20.08	21.70
667	66.7	73.8	20.11	21.73
668	66.8	73.9	20.14	21.76
669	66.9	74.0	20.17	21.79
670	67.0	74.1	20.20	21.82
671	67.1	74.2	20.23	21.85
672	67.2	74.3	20.26	21.88
673	67.3	74.4	20.29	21.91
674	67.4	74.5	20.32	21.94
675	67.5	74.7	20.35	21.97
676	67.6	74.8	20.38	22.00
677	67.7	74.9	20.41	22.03
678	67.8	75.0	20.44	22.07
679	67.9	75.1	20.47	22.10

室内ユニット 合計容量	能力 (kW)		入力 (kW)	
	冷房	暖房	冷房	暖房
680	68.0	75.2	20.50	22.13
681	68.1	75.3	20.53	22.16
682	68.2	75.4	20.56	22.19
683	68.3	75.5	20.59	22.22
684	68.4	75.7	20.62	22.25
685	68.5	75.8	20.64	22.28
686	68.6	75.9	20.67	22.31
687	68.7	76.0	20.70	22.34
688	68.8	76.1	20.73	22.37
689	68.9	76.2	20.76	22.40
690	69.0	76.3	20.79	22.43
691	69.1	76.4	20.82	22.46
692	69.2	76.5	20.85	22.49
693	69.3	76.6	20.88	22.52
694	69.4	76.8	20.91	22.55
695	69.5	76.9	20.94	22.58
696	69.6	77.0	20.97	22.60
697	69.7	77.1	21.00	22.63
698	69.8	77.2	21.02	22.66
699	69.9	77.3	21.05	22.69
700	70.0	77.4	21.08	22.72
701	70.1	77.5	21.11	22.75
702	70.2	77.6	21.14	22.78
703	70.3	77.8	21.17	22.81
704	70.4	77.9	21.20	22.84
705	70.5	78.0	21.23	22.87
706	70.6	78.1	21.25	22.90
707	70.7	78.2	21.28	22.93
708	70.8	78.3	21.31	22.96
709	70.9	78.4	21.34	22.99
710	71.0	78.5	21.37	23.01
711	71.1	78.6	21.40	23.04
712	71.2	78.7	21.43	23.07
713	71.3	78.9	21.45	23.10
714	71.4	79.0	21.48	23.13
715	71.5	79.1	21.51	23.16
716	71.6	79.2	21.54	23.19
717	71.7	79.3	21.57	23.21
718	71.8	79.4	21.60	23.24
719	71.9	79.5	21.62	23.27
720	72.0	79.6	21.65	23.30
721	72.1	79.7	21.68	23.33
722	72.2	79.9	21.71	23.36
723	72.3	80.0	21.74	23.39
724	72.4	80.1	21.76	23.41
725	72.5	80.2	21.79	23.44
726	72.6	80.3	21.82	23.47
727	72.7	80.4	21.85	23.50
728	72.8	80.5	21.87	23.53
729	72.9	80.6	21.90	23.55
730	73.0	80.7	21.93	23.58
731	73.1	80.8	21.96	23.61
732	73.2	81.0	21.99	23.64
733	73.3	81.1	22.01	23.67
734	73.4	81.2	22.04	23.69
735	73.5	81.3	22.07	23.72
736	73.6	81.4	22.10	23.75
737	73.7	81.5	22.12	23.78
738	73.8	81.6	22.15	23.80
739	73.9	81.7	22.18	23.83
740	74.0	81.8	22.21	23.86
741	74.1	82.0	22.23	23.89
742	74.2	82.1	22.26	23.91
743	74.3	82.2	22.29	23.94
744	74.4	82.3	22.31	23.97
745	74.5	82.4	22.34	24.00
746	74.6	82.5	22.37	24.02
747	74.7	82.6	22.40	24.05
748	74.8	82.7	22.42	24.08
749	74.9	82.8	22.45	24.10

【PUHY-P1080SKM-E】

室内ユニット 合計容量	能力 (kW)		入力 (kW)	
	冷房	暖房	冷房	暖房
750	75.0	83.0	22.48	24.13
751	75.1	83.1	22.50	24.16
752	75.2	83.2	22.53	24.18
753	75.3	83.3	22.56	24.21
754	75.4	83.4	22.58	24.24
755	75.5	83.5	22.61	24.27
756	75.6	83.6	22.64	24.29
757	75.7	83.7	22.66	24.32
758	75.8	83.8	22.69	24.35
759	75.9	83.9	22.72	24.37
760	76.0	84.1	22.74	24.40
761	76.1	84.2	22.77	24.42
762	76.2	84.3	22.80	24.45
763	76.3	84.4	22.82	24.48
764	76.4	84.5	22.85	24.50
765	76.5	84.6	22.88	24.53
766	76.6	84.7	22.90	24.56
767	76.7	84.8	22.93	24.58
768	76.8	84.9	22.95	24.61
769	76.9	85.1	22.98	24.63
770	77.0	85.2	23.01	24.66
771	77.1	85.3	23.03	24.69
772	77.2	85.4	23.06	24.71
773	77.3	85.5	23.09	24.74
774	77.4	85.6	23.11	24.76
775	77.5	85.7	23.14	24.79
776	77.6	85.8	23.16	24.82
777	77.7	85.9	23.19	24.84
778	77.8	86.0	23.21	24.87
779	77.9	86.2	23.24	24.89
780	78.0	86.3	23.27	24.92
781	78.1	86.4	23.29	24.94
782	78.2	86.5	23.32	24.97
783	78.3	86.6	23.34	24.99
784	78.4	86.7	23.37	25.02
785	78.5	86.8	23.39	25.05
786	78.6	86.9	23.42	25.07
787	78.7	87.0	23.45	25.10
788	78.8	87.2	23.47	25.12
789	78.9	87.3	23.50	25.15
790	79.0	87.4	23.52	25.17
791	79.1	87.5	23.55	25.20
792	79.2	87.6	23.57	25.22
793	79.3	87.7	23.60	25.25
794	79.4	87.8	23.62	25.27
795	79.5	87.9	23.65	25.30
796	79.6	88.0	23.67	25.32
797	79.7	88.1	23.70	25.35
798	79.8	88.3	23.72	25.37
799	79.9	88.4	23.75	25.39
800	80.0	88.5	23.77	25.42
801	80.1	88.6	23.80	25.44
802	80.2	88.7	23.82	25.47
803	80.3	88.8	23.85	25.49
804	80.4	88.9	23.87	25.52
805	80.5	89.0	23.90	25.54
806	80.6	89.1	23.92	25.57
807	80.7	89.3	23.95	25.59
808	80.8	89.4	23.97	25.61
809	80.9	89.5	24.00	25.64
810	81.0	89.6	24.02	25.66
811	81.1	89.7	24.05	25.69
812	81.2	89.8	24.07	25.71
813	81.3	89.9	24.09	25.73
814	81.4	90.0	24.12	25.76
815	81.5	90.1	24.14	25.78
816	81.6	90.2	24.17	25.81
817	81.7	90.4	24.19	25.83
818	81.8	90.5	24.22	25.85
819	81.9	90.6	24.24	25.88

室内ユニット 合計容量	能力 (kW)		入力 (kW)	
	冷房	暖房	冷房	暖房
820	82.0	90.7	24.26	25.90
821	82.1	90.8	24.29	25.92
822	82.2	90.9	24.31	25.95
823	82.3	91.0	24.34	25.97
824	82.4	91.1	24.36	26.00
825	82.5	91.2	24.39	26.02
826	82.6	91.4	24.41	26.04
827	82.7	91.5	24.43	26.07
828	82.8	91.6	24.46	26.09
829	82.9	91.7	24.48	26.11
830	83.0	91.8	24.50	26.13
831	83.1	91.9	24.53	26.16
832	83.2	92.0	24.55	26.18
833	83.3	92.1	24.58	26.20
834	83.4	92.2	24.60	26.23
835	83.5	92.4	24.62	26.25
836	83.6	92.5	24.65	26.27
837	83.7	92.6	24.67	26.30
838	83.8	92.7	24.69	26.32
839	83.9	92.8	24.72	26.34
840	84.0	92.9	24.74	26.36
841	84.1	93.0	24.76	26.39
842	84.2	93.1	24.79	26.41
843	84.3	93.2	24.81	26.43
844	84.4	93.3	24.83	26.45
845	84.5	93.5	24.86	26.48
846	84.6	93.6	24.88	26.50
847	84.7	93.7	24.90	26.52
848	84.8	93.8	24.93	26.54
849	84.9	93.9	24.95	26.57
850	85.0	94.0	24.97	26.59
851	85.1	94.1	25.00	26.61
852	85.2	94.2	25.02	26.63
853	85.3	94.3	25.04	26.65
854	85.4	94.5	25.06	26.68
855	85.5	94.6	25.09	26.70
856	85.6	94.7	25.11	26.72
857	85.7	94.8	25.13	26.74
858	85.8	94.9	25.16	26.76
859	85.9	95.0	25.18	26.79
860	86.0	95.1	25.20	26.81
861	86.1	95.2	25.22	26.83
862	86.2	95.3	25.25	26.85
863	86.3	95.4	25.27	26.87
864	86.4	95.6	25.29	26.89
865	86.5	95.7	25.31	26.91
866	86.6	95.8	25.34	26.94
867	86.7	95.9	25.36	26.96
868	86.8	96.0	25.38	26.98
869	86.9	96.1	25.40	27.00
870	87.0	96.2	25.43	27.02
871	87.1	96.3	25.45	27.04
872	87.2	96.4	25.47	27.06
873	87.3	96.6	25.49	27.08
874	87.4	96.7	25.51	27.11
875	87.5	96.8	25.54	27.13
876	87.6	96.9	25.56	27.15
877	87.7	97.0	25.58	27.17
878	87.8	97.1	25.60	27.19
879	87.9	97.2	25.62	27.21
880	88.0	97.3	25.65	27.23
881	88.1	97.4	25.67	27.25
882	88.2	97.5	25.69	27.27
883	88.3	97.7	25.71	27.29
884	88.4	97.8	25.73	27.31
885	88.5	97.9	25.75	27.33
886	88.6	98.0	25.78	27.35
887	88.7	98.1	25.80	27.38
888	88.8	98.2	25.82	27.40
889	88.9	98.3	25.84	27.42

室内ユニット 合計容量	能力 (kW)		入力 (kW)	
	冷房	暖房	冷房	暖房
890	89.0	98.4	25.86	27.44
891	89.1	98.5	25.88	27.46
892	89.2	98.7	25.91	27.48
893	89.3	98.8	25.93	27.50
894	89.4	98.9	25.95	27.52
895	89.5	99.0	25.97	27.54
896	89.6	99.1	25.99	27.56
897	89.7	99.2	26.01	27.58
898	89.8	99.3	26.03	27.60
899	89.9	99.4	26.05	27.62
900	90.0	99.5	26.08	27.64
901	90.1	99.7	26.10	27.66
902	90.2	99.8	26.12	27.68
903	90.3	99.9	26.14	27.70
904	90.4	100.0	26.16	27.72
905	90.5	100.1	26.18	27.73
906	90.6	100.2	26.20	27.75
907	90.7	100.3	26.22	27.77
908	90.8	100.4	26.24	27.79
909	90.9	100.5	26.26	27.81
910	91.0	100.6	26.28	27.83
911	91.1	100.8	26.30	27.85
912	91.2	100.9	26.33	27.87
913	91.3	101.0	26.35	27.89
914	91.4	101.1	26.37	27.91
915	91.5	101.2	26.39	27.93
916	91.6	101.3	26.41	27.95
917	91.7	101.4	26.43	27.97
918	91.8	101.5	26.45	27.98
919	91.9	101.6	26.47	28.00
920	92.0	101.8	26.49	28.02
921	92.1	101.9	26.51	28.04
922	92.2	102.0	26.53	28.06
923	92.3	102.1	26.55	28.08
924	92.4	102.2	26.57	28.10
925	92.5	102.3	26.59	28.12
926	92.6	102.4	26.61	28.13
927	92.7	102.5	26.63	28.15
928	92.8	102.6	26.65	28.17
929	92.9	102.7	26.67	28.19
930	93.0	102.9	26.69	28.21
931	93.1	103.0	26.71	28.23
932	93.2	103.1	26.73	28.24
933	93.3	103.2	26.75	28.26
934	93.4	103.3	26.77	28.28
935	93.5	103.4	26.79	28.30
936	93.6	103.5	26.81	28.32
937	93.7	103.6	26.83	28.34
938	93.8	103.7	26.85	28.35
939	93.9	103.9	26.87	28.37
940	94.0	104.0	26.89	28.39
941	94.1	104.1	26.91	28.41
942	94.2	104.2	26.93	28.42
943	94.3	104.3	26.94	28.44
944	94.4	104.4	26.96	28.46
945	94.5	104.5	26.98	28.48
946	94.6	104.6	27.00	28.50
947	94.7	104.7	27.02	28.51
948	94.8	104.8	27.04	28.53
949	94.9	105.0	27.06	28.55
950	95.0	105.1	27.08	28.57
951	95.1	105.2	27.10	28.58
952	95.2	105.3	27.12	28.60
953	95.3	105.4	27.14	28.62
954	95.4	105.5	27.16	28.63
955	95.5	105.6	27.17	28.65
956	95.6	105.7	27.19	28.67
957	95.7	105.8	27.21	28.69
958	95.8	106.0	27.23	28.70
959	95.9	106.1	27.25	28.72

【PUHY-P1080SKM-E】

室内ユニット 合計容量	能力 (kW)		入力 (kW)	
	冷房	暖房	冷房	暖房
960	96.0	106.2	27.27	28.74
961	96.1	106.3	27.29	28.75
962	96.2	106.4	27.31	28.77
963	96.3	106.5	27.33	28.79
964	96.4	106.6	27.34	28.80
965	96.5	106.7	27.36	28.82
966	96.6	106.8	27.38	28.84
967	96.7	107.0	27.40	28.85
968	96.8	107.1	27.42	28.87
969	96.9	107.2	27.44	28.89
970	97.0	107.3	27.45	28.90
971	97.1	107.4	27.47	28.92
972	97.2	107.5	27.49	28.94
973	97.3	107.6	27.51	28.95
974	97.4	107.7	27.53	28.97
975	97.5	107.8	27.55	28.98
976	97.6	107.9	27.56	29.00
977	97.7	108.1	27.58	29.02
978	97.8	108.2	27.60	29.03
979	97.9	108.3	27.62	29.05
980	98.0	108.4	27.64	29.06
981	98.1	108.5	27.65	29.08
982	98.2	108.6	27.67	29.10
983	98.3	108.7	27.69	29.11
984	98.4	108.8	27.71	29.13
985	98.5	108.9	27.73	29.14
986	98.6	109.1	27.74	29.16
987	98.7	109.2	27.76	29.18
988	98.8	109.3	27.78	29.19
989	98.9	109.4	27.80	29.21
990	99.0	109.5	27.81	29.22
991	99.1	109.6	27.83	29.24
992	99.2	109.7	27.85	29.25
993	99.3	109.8	27.87	29.27
994	99.4	109.9	27.88	29.28
995	99.5	110.0	27.90	29.30
996	99.6	110.2	27.92	29.31
997	99.7	110.3	27.94	29.33
998	99.8	110.4	27.95	29.34
999	99.9	110.5	27.97	29.36
1000	100.0	110.6	27.99	29.37
1001	100.1	110.7	28.00	29.39
1002	100.2	110.8	28.02	29.40
1003	100.3	110.9	28.04	29.42
1004	100.4	111.0	28.06	29.43
1005	100.5	111.2	28.07	29.45
1006	100.6	111.3	28.09	29.46
1007	100.7	111.4	28.11	29.48
1008	100.8	111.5	28.12	29.49
1009	100.9	111.6	28.14	29.51
1010	101.0	111.7	28.16	29.52
1011	101.1	111.8	28.17	29.54
1012	101.2	111.9	28.19	29.55
1013	101.3	112.0	28.21	29.56
1014	101.4	112.1	28.22	29.58
1015	101.5	112.3	28.24	29.59
1016	101.6	112.4	28.26	29.61
1017	101.7	112.5	28.27	29.62
1018	101.8	112.6	28.29	29.64
1019	101.9	112.7	28.31	29.65
1020	102.0	112.8	28.32	29.66
1021	102.1	112.9	28.34	29.68
1022	102.2	113.0	28.36	29.69
1023	102.3	113.1	28.37	29.71
1024	102.4	113.3	28.39	29.72
1025	102.5	113.4	28.40	29.73
1026	102.6	113.5	28.42	29.75
1027	102.7	113.6	28.44	29.76
1028	102.8	113.7	28.45	29.77
1029	102.9	113.8	28.47	29.79

室内ユニット 合計容量	能力 (kW)		入力 (kW)	
	冷房	暖房	冷房	暖房
1030	103.0	113.9	28.48	29.80
1031	103.1	114.0	28.50	29.82
1032	103.2	114.1	28.52	29.83
1033	103.3	114.2	28.53	29.84
1034	103.4	114.4	28.55	29.86
1035	103.5	114.5	28.56	29.87
1036	103.6	114.6	28.58	29.88
1037	103.7	114.7	28.60	29.90
1038	103.8	114.8	28.61	29.91
1039	103.9	114.9	28.63	29.92
1040	104.0	115.0	28.64	29.93
1041	104.1	115.1	28.66	29.95
1042	104.2	115.2	28.67	29.96
1043	104.3	115.4	28.69	29.97
1044	104.4	115.5	28.70	29.99
1045	104.5	115.6	28.72	30.00
1046	104.6	115.7	28.74	30.01
1047	104.7	115.8	28.75	30.03
1048	104.8	115.9	28.77	30.04
1049	104.9	116.0	28.78	30.05
1050	105.0	116.1	28.80	30.06
1051	105.1	116.2	28.81	30.08
1052	105.2	116.4	28.83	30.09
1053	105.3	116.5	28.84	30.10
1054	105.4	116.6	28.86	30.11
1055	105.5	116.7	28.87	30.13
1056	105.6	116.8	28.89	30.14
1057	105.7	116.9	28.90	30.15
1058	105.8	117.0	28.92	30.16
1059	105.9	117.1	28.93	30.17
1060	106.0	117.2	28.95	30.19
1061	106.1	117.3	28.96	30.20
1062	106.2	117.5	28.98	30.21
1063	106.3	117.6	28.99	30.22
1064	106.4	117.7	29.01	30.23
1065	106.5	117.8	29.02	30.25
1066	106.6	117.9	29.04	30.26
1067	106.7	118.0	29.05	30.27
1068	106.8	118.1	29.06	30.28
1069	106.9	118.2	29.08	30.29
1070	107.0	118.3	29.09	30.31
1071	107.1	118.5	29.11	30.32
1072	107.2	118.6	29.12	30.33
1073	107.3	118.7	29.14	30.34
1074	107.4	118.8	29.15	30.35
1075	107.5	118.9	29.17	30.36
1076	107.6	119.0	29.18	30.37
1077	107.7	119.1	29.19	30.39
1078	107.8	119.2	29.21	30.40
1079	107.9	119.3	29.22	30.41
1080	108.0	119.5	29.23	30.42
1081	108.0	119.5	29.23	30.41
1082	108.1	119.5	29.23	30.41
1083	108.1	119.5	29.23	30.40
1084	108.1	119.5	29.23	30.40
1085	108.1	119.5	29.24	30.39
1086	108.1	119.5	29.24	30.39
1087	108.2	119.6	29.24	30.38
1088	108.2	119.6	29.24	30.38
1089	108.2	119.6	29.24	30.37
1090	108.2	119.6	29.24	30.36
1091	108.3	119.6	29.24	30.36
1092	108.3	119.6	29.24	30.35
1093	108.3	119.6	29.24	30.35
1094	108.3	119.6	29.25	30.34
1095	108.4	119.7	29.25	30.34
1096	108.4	119.7	29.25	30.33
1097	108.4	119.7	29.25	30.33
1098	108.4	119.7	29.25	30.32
1099	108.5	119.7	29.25	30.32

室内ユニット 合計容量	能力 (kW)		入力 (kW)	
	冷房	暖房	冷房	暖房
1100	108.5	119.7	29.25	30.31
1101	108.5	119.7	29.25	30.30
1102	108.5	119.8	29.26	30.30
1103	108.6	119.8	29.26	30.29
1104	108.6	119.8	29.26	30.29
1105	108.6	119.8	29.26	30.28
1106	108.6	119.8	29.26	30.28
1107	108.7	119.8	29.26	30.27
1108	108.7	119.8	29.26	30.27
1109	108.7	119.8	29.26	30.26
1110	108.7	119.9	29.27	30.26
1111	108.8	119.9	29.27	30.25
1112	108.8	119.9	29.27	30.25
1113	108.8	119.9	29.27	30.24
1114	108.8	119.9	29.27	30.23
1115	108.9	119.9	29.27	30.23
1116	108.9	119.9	29.27	30.22
1117	108.9	119.9	29.27	30.22
1118	108.9	120.0	29.28	30.21
1119	109.0	120.0	29.28	30.21
1120	109.0	120.0	29.28	30.20
1121	109.0	120.0	29.28	30.20
1122	109.0	120.0	29.28	30.19
1123	109.0	120.0	29.28	30.19
1124	109.1	120.0	29.28	30.18
1125	109.1	120.0	29.28	30.17
1126	109.1	120.1	29.28	30.17
1127	109.1	120.1	29.29	30.16
1128	109.2	120.1	29.29	30.16
1129	109.2	120.1	29.29	30.15
1130	109.2	120.1	29.29	30.15
1131	109.2	120.1	29.29	30.14
1132	109.3	120.1	29.29	30.14
1133	109.3	120.1	29.29	30.13
1134	109.3	120.2	29.29	30.13
1135	109.3	120.2	29.30	30.12
1136	109.4	120.2	29.30	30.12
1137	109.4	120.2	29.30	30.11
1138	109.4	120.2	29.30	30.10
1139	109.4	120.2	29.30	30.10
1140	109.5	120.2	29.30	30.09
1141	109.5	120.2	29.30	30.09
1142	109.5	120.3	29.30	30.08
1143	109.5	120.3	29.31	30.08
1144	109.6	120.3	29.31	30.07
1145	109.6	120.3	29.31	30.07
1146	109.6	120.3	29.31	30.06
1147	109.6	120.3	29.31	30.06
1148	109.7	120.3	29.31	30.05
1149	109.7	120.3	29.31	30.04
1150	109.7	120.4	29.31	30.04
1151	109.7	120.4	29.32	30.03
1152	109.8	120.4	29.32	30.03
1153	109.8	120.4	29.32	30.02
1154	109.8	120.4	29.32	30.02
1155	109.8	120.4	29.32	30.01
1156	109.8	120.4	29.32	30.01
1157	109.9	120.5	29.32	30.00
1158	109.9	120.5	29.32	30.00
1159	109.9	120.5	29.32	29.99
1160	109.9	120.5	29.33	29.99
1161	110.0	120.5	29.33	29.98
1162	110.0	120.5	29.33	29.97
1163	110.0	120.5	29.33	29.97
1164	110.0	120.5	29.33	29.96
1165	110.1	120.6	29.33	29.96
1166	110.1	120.6	29.33	29.95
1167	110.1	120.6	29.33	29.95
1168	110.1	120.6	29.34	29.94
1169	110.2	120.6	29.34	29.94

## 【PUHY-P1080SKM-E】

室内ユニット 合計容量	能力 (kW)		入力 (kW)	
	冷房	暖房	冷房	暖房
1170	110.2	120.6	29.34	29.93
1171	110.2	120.6	29.34	29.93
1172	110.2	120.6	29.34	29.92
1173	110.3	120.7	29.34	29.91
1174	110.3	120.7	29.34	29.91
1175	110.3	120.7	29.34	29.90
1176	110.3	120.7	29.35	29.90
1177	110.4	120.7	29.35	29.89
1178	110.4	120.7	29.35	29.89
1179	110.4	120.7	29.35	29.88
1180	110.4	120.7	29.35	29.88
1181	110.5	120.8	29.35	29.87
1182	110.5	120.8	29.35	29.87
1183	110.5	120.8	29.35	29.86
1184	110.5	120.8	29.36	29.86
1185	110.6	120.8	29.36	29.85
1186	110.6	120.8	29.36	29.84
1187	110.6	120.8	29.36	29.84
1188	110.6	120.8	29.36	29.83
1189	110.7	120.9	29.36	29.83
1190	110.7	120.9	29.36	29.82
1191	110.7	120.9	29.36	29.82
1192	110.7	120.9	29.36	29.81
1193	110.7	120.9	29.37	29.81
1194	110.8	120.9	29.37	29.80
1195	110.8	120.9	29.37	29.80
1196	110.8	120.9	29.37	29.79
1197	110.8	121.0	29.37	29.78
1198	110.9	121.0	29.37	29.78
1199	110.9	121.0	29.37	29.77
1200	110.9	121.0	29.37	29.77
1201	110.9	121.0	29.38	29.76
1202	111.0	121.0	29.38	29.76
1203	111.0	121.0	29.38	29.75
1204	111.0	121.1	29.38	29.75
1205	111.0	121.1	29.38	29.74
1206	111.1	121.1	29.38	29.74
1207	111.1	121.1	29.38	29.73
1208	111.1	121.1	29.38	29.73
1209	111.1	121.1	29.39	29.72
1210	111.2	121.1	29.39	29.71
1211	111.2	121.1	29.39	29.71
1212	111.2	121.2	29.39	29.70
1213	111.2	121.2	29.39	29.70
1214	111.3	121.2	29.39	29.69
1215	111.3	121.2	29.39	29.69
1216	111.3	121.2	29.39	29.68
1217	111.3	121.2	29.40	29.68
1218	111.4	121.2	29.40	29.67
1219	111.4	121.2	29.40	29.67
1220	111.4	121.3	29.40	29.66
1221	111.4	121.3	29.40	29.65
1222	111.5	121.3	29.40	29.65
1223	111.5	121.3	29.40	29.64
1224	111.5	121.3	29.40	29.64
1225	111.5	121.3	29.40	29.63
1226	111.5	121.3	29.41	29.63
1227	111.6	121.3	29.41	29.62
1228	111.6	121.4	29.41	29.62
1229	111.6	121.4	29.41	29.61
1230	111.6	121.4	29.41	29.61
1231	111.7	121.4	29.41	29.60
1232	111.7	121.4	29.41	29.60
1233	111.7	121.4	29.41	29.59
1234	111.7	121.4	29.42	29.58
1235	111.8	121.4	29.42	29.58
1236	111.8	121.5	29.42	29.57
1237	111.8	121.5	29.42	29.57
1238	111.8	121.5	29.42	29.56
1239	111.9	121.5	29.42	29.56

室内ユニット 合計容量	能力 (kW)		入力 (kW)	
	冷房	暖房	冷房	暖房
1240	111.9	121.5	29.42	29.55
1241	111.9	121.5	29.42	29.55
1242	111.9	121.5	29.43	29.54
1243	112.0	121.5	29.43	29.54
1244	112.0	121.6	29.43	29.53
1245	112.0	121.6	29.43	29.52
1246	112.0	121.6	29.43	29.52
1247	112.1	121.6	29.43	29.51
1248	112.1	121.6	29.43	29.51
1249	112.1	121.6	29.43	29.50
1250	112.1	121.6	29.44	29.50
1251	112.2	121.7	29.44	29.49
1252	112.2	121.7	29.44	29.49
1253	112.2	121.7	29.44	29.48
1254	112.2	121.7	29.44	29.48
1255	112.3	121.7	29.44	29.47
1256	112.3	121.7	29.44	29.46
1257	112.3	121.7	29.44	29.46
1258	112.3	121.7	29.44	29.45
1259	112.4	121.8	29.45	29.45
1260	112.4	121.8	29.45	29.44
1261	112.4	121.8	29.45	29.44
1262	112.4	121.8	29.45	29.43
1263	112.4	121.8	29.45	29.43
1264	112.5	121.8	29.45	29.42
1265	112.5	121.8	29.45	29.42
1266	112.5	121.8	29.45	29.41
1267	112.5	121.9	29.46	29.41
1268	112.6	121.9	29.46	29.40
1269	112.6	121.9	29.46	29.39
1270	112.6	121.9	29.46	29.39
1271	112.6	121.9	29.46	29.38
1272	112.7	121.9	29.46	29.38
1273	112.7	121.9	29.46	29.37
1274	112.7	121.9	29.46	29.37
1275	112.7	122.0	29.47	29.36
1276	112.8	122.0	29.47	29.36
1277	112.8	122.0	29.47	29.35
1278	112.8	122.0	29.47	29.35
1279	112.8	122.0	29.47	29.34
1280	112.9	122.0	29.47	29.33
1281	112.9	122.0	29.47	29.33
1282	112.9	122.0	29.47	29.32
1283	112.9	122.1	29.47	29.32
1284	113.0	122.1	29.48	29.31
1285	113.0	122.1	29.48	29.31
1286	113.0	122.1	29.48	29.30
1287	113.0	122.1	29.48	29.30
1288	113.1	122.1	29.48	29.29
1289	113.1	122.1	29.48	29.29
1290	113.1	122.1	29.48	29.28
1291	113.1	122.2	29.48	29.28
1292	113.2	122.2	29.49	29.27
1293	113.2	122.2	29.49	29.26
1294	113.2	122.2	29.49	29.26
1295	113.2	122.2	29.49	29.25
1296	113.2	122.2	29.49	29.25
1297	113.3	122.2	29.49	29.24
1298	113.3	122.2	29.49	29.24
1299	113.3	122.3	29.49	29.23
1300	113.3	122.3	29.50	29.23
1301	113.4	122.3	29.50	29.22
1302	113.4	122.3	29.50	29.22
1303	113.4	122.3	29.50	29.21
1304	113.4	122.3	29.50	29.20
1305	113.5	122.3	29.50	29.20
1306	113.5	122.4	29.50	29.19
1307	113.5	122.4	29.50	29.19
1308	113.5	122.4	29.51	29.18
1309	113.6	122.4	29.51	29.18

室内ユニット 合計容量	能力 (kW)		入力 (kW)	
	冷房	暖房	冷房	暖房
1310	113.6	122.4	29.51	29.17
1311	113.6	122.4	29.51	29.17
1312	113.6	122.4	29.51	29.16
1313	113.7	122.4	29.51	29.16
1314	113.7	122.5	29.51	29.15
1315	113.7	122.5	29.51	29.15
1316	113.7	122.5	29.51	29.14
1317	113.8	122.5	29.52	29.13
1318	113.8	122.5	29.52	29.13
1319	113.8	122.5	29.52	29.12
1320	113.8	122.5	29.52	29.12
1321	113.9	122.5	29.52	29.11
1322	113.9	122.6	29.52	29.11
1323	113.9	122.6	29.52	29.10
1324	113.9	122.6	29.52	29.10
1325	114.0	122.6	29.53	29.09
1326	114.0	122.6	29.53	29.09
1327	114.0	122.6	29.53	29.08
1328	114.0	122.6	29.53	29.07
1329	114.1	122.6	29.53	29.07
1330	114.1	122.7	29.53	29.06
1331	114.1	122.7	29.53	29.06
1332	114.1	122.7	29.53	29.05
1333	114.1	122.7	29.54	29.05
1334	114.2	122.7	29.54	29.04
1335	114.2	122.7	29.54	29.04
1336	114.2	122.7	29.54	29.03
1337	114.2	122.7	29.54	29.03
1338	114.3	122.8	29.54	29.02
1339	114.3	122.8	29.54	29.02
1340	114.3	122.8	29.54	29.01
1341	114.3	122.8	29.55	29.00
1342	114.4	122.8	29.55	29.00
1343	114.4	122.8	29.55	28.99
1344	114.4	122.8	29.55	28.99
1345	114.4	122.8	29.55	28.98
1346	114.5	122.9	29.55	28.98
1347	114.5	122.9	29.55	28.97
1348	114.5	122.9	29.55	28.97
1349	114.5	122.9	29.55	28.96
1350	114.6	122.9	29.56	28.96
1351	114.6	122.9	29.56	28.95
1352	114.6	122.9	29.56	28.94
1353	114.6	123.0	29.56	28.94
1354	114.7	123.0	29.56	28.93
1355	114.7	123.0	29.56	28.93
1356	114.7	123.0	29.56	28.92
1357	114.7	123.0	29.56	28.92
1358	114.8	123.0	29.57	28.91
1359	114.8	123.0	29.57	28.91
1360	114.8	123.0	29.57	28.90
1361	114.8	123.1	29.57	28.90
1362	114.9	123.1	29.57	28.89
1363	114.9	123.1	29.57	28.89
1364	114.9	123.1	29.57	28.88
1365	114.9	123.1	29.57	28.87
1366	115.0	123.1	29.58	28.87
1367	115.0	123.1	29.58	28.86
1368	115.0	123.1	29.58	28.86
1369	115.0	123.2	29.58	28.85
1370	115.0	123.2	29.58	28.85
1371	115.1	123.2	29.58	28.84
1372	115.1	123.2	29.58	28.84
1373	115.1	123.2	29.58	28.83
1374	115.1	123.2	29.59	28.83
1375	115.2	123.2	29.59	28.82
1376	115.2	123.2	29.59	28.81
1377	115.2	123.3	29.59	28.81
1378	115.2	123.3	29.59	28.80
1379	115.3	123.3	29.59	28.80

### 【PUHY-P1080SKM-E】

室内工外 合計容量	能力 (kW)		入力 (kW)	
	冷房	暖房	冷房	暖房
1380	115.3	123.3	29.59	28.79
1381	115.3	123.3	29.59	28.79
1382	115.3	123.3	29.59	28.78
1383	115.4	123.3	29.60	28.78
1384	115.4	123.3	29.60	28.77
1385	115.4	123.4	29.60	28.77
1386	115.4	123.4	29.60	28.76
1387	115.5	123.4	29.60	28.76
1388	115.5	123.4	29.60	28.75
1389	115.5	123.4	29.60	28.74
1390	115.5	123.4	29.60	28.74
1391	115.6	123.4	29.61	28.73
1392	115.6	123.4	29.61	28.73
1393	115.6	123.5	29.61	28.72
1394	115.6	123.5	29.61	28.72
1395	115.7	123.5	29.61	28.71
1396	115.7	123.5	29.61	28.71
1397	115.7	123.5	29.61	28.70
1398	115.7	123.5	29.61	28.70
1399	115.8	123.5	29.62	28.69
1400	115.8	123.6	29.62	28.68
1401	115.8	123.6	29.62	28.68
1402	115.8	123.6	29.62	28.67
1403	115.8	123.6	29.62	28.67
1404	115.9	123.6	29.62	28.66

【PUHY-P1130SKM-E】

室内ユニット 合計容量	能力 (kW)		入力 (kW)	
	冷房	暖房	冷房	暖房
565	56.5	63.5	16.63	18.11
566	56.6	63.6	16.66	18.14
567	56.7	63.7	16.70	18.18
568	56.8	63.8	16.73	18.21
569	56.9	64.0	16.76	18.25
570	57.0	64.1	16.80	18.28
571	57.1	64.2	16.83	18.31
572	57.2	64.3	16.87	18.35
573	57.3	64.4	16.90	18.38
574	57.4	64.5	16.93	18.42
575	57.5	64.6	16.97	18.45
576	57.6	64.7	17.00	18.49
577	57.7	64.9	17.04	18.52
578	57.8	65.0	17.07	18.55
579	57.9	65.1	17.10	18.59
580	58.0	65.2	17.14	18.62
581	58.1	65.3	17.17	18.66
582	58.2	65.4	17.20	18.69
583	58.3	65.5	17.24	18.72
584	58.4	65.6	17.27	18.76
585	58.5	65.8	17.30	18.79
586	58.6	65.9	17.34	18.83
587	58.7	66.0	17.37	18.86
588	58.8	66.1	17.41	18.89
589	58.9	66.2	17.44	18.93
590	59.0	66.3	17.47	18.96
591	59.1	66.4	17.51	18.99
592	59.2	66.5	17.54	19.03
593	59.3	66.7	17.57	19.06
594	59.4	66.8	17.61	19.09
595	59.5	66.9	17.64	19.13
596	59.6	67.0	17.67	19.16
597	59.7	67.1	17.70	19.20
598	59.8	67.2	17.74	19.23
599	59.9	67.3	17.77	19.26
600	60.0	67.4	17.80	19.30
601	60.1	67.6	17.84	19.33
602	60.2	67.7	17.87	19.36
603	60.3	67.8	17.90	19.40
604	60.4	67.9	17.94	19.43
605	60.5	68.0	17.97	19.46
606	60.6	68.1	18.00	19.50
607	60.7	68.2	18.03	19.53
608	60.8	68.3	18.07	19.56
609	60.9	68.5	18.10	19.60
610	61.0	68.6	18.13	19.63
611	61.1	68.7	18.17	19.66
612	61.2	68.8	18.20	19.69
613	61.3	68.9	18.23	19.73
614	61.4	69.0	18.26	19.76
615	61.5	69.1	18.30	19.79
616	61.6	69.2	18.33	19.83
617	61.7	69.4	18.36	19.86
618	61.8	69.5	18.39	19.89
619	61.9	69.6	18.43	19.92
620	62.0	69.7	18.46	19.96
621	62.1	69.8	18.49	19.99
622	62.2	69.9	18.52	20.02
623	62.3	70.0	18.56	20.06
624	62.4	70.1	18.59	20.09
625	62.5	70.3	18.62	20.12
626	62.6	70.4	18.65	20.15
627	62.7	70.5	18.69	20.19
628	62.8	70.6	18.72	20.22
629	62.9	70.7	18.75	20.25
630	63.0	70.8	18.78	20.28
631	63.1	70.9	18.81	20.32
632	63.2	71.0	18.85	20.35
633	63.3	71.1	18.88	20.38
634	63.4	71.3	18.91	20.41

室内ユニット 合計容量	能力 (kW)		入力 (kW)	
	冷房	暖房	冷房	暖房
635	63.5	71.4	18.94	20.45
636	63.6	71.5	18.97	20.48
637	63.7	71.6	19.01	20.51
638	63.8	71.7	19.04	20.54
639	63.9	71.8	19.07	20.57
640	64.0	71.9	19.10	20.61
641	64.1	72.0	19.13	20.64
642	64.2	72.2	19.17	20.67
643	64.3	72.3	19.20	20.70
644	64.4	72.4	19.23	20.74
645	64.5	72.5	19.26	20.77
646	64.6	72.6	19.29	20.80
647	64.7	72.7	19.32	20.83
648	64.8	72.8	19.36	20.86
649	64.9	72.9	19.39	20.90
650	65.0	73.1	19.42	20.93
651	65.1	73.2	19.45	20.96
652	65.2	73.3	19.48	20.99
653	65.3	73.4	19.51	21.02
654	65.4	73.5	19.55	21.05
655	65.5	73.6	19.58	21.09
656	65.6	73.7	19.61	21.12
657	65.7	73.8	19.64	21.15
658	65.8	74.0	19.67	21.18
659	65.9	74.1	19.70	21.21
660	66.0	74.2	19.73	21.24
661	66.1	74.3	19.76	21.28
662	66.2	74.4	19.80	21.31
663	66.3	74.5	19.83	21.34
664	66.4	74.6	19.86	21.37
665	66.5	74.7	19.89	21.40
666	66.6	74.9	19.92	21.43
667	66.7	75.0	19.95	21.46
668	66.8	75.1	19.98	21.50
669	66.9	75.2	20.01	21.53
670	67.0	75.3	20.04	21.56
671	67.1	75.4	20.08	21.59
672	67.2	75.5	20.11	21.62
673	67.3	75.6	20.14	21.65
674	67.4	75.8	20.17	21.68
675	67.5	75.9	20.20	21.71
676	67.6	76.0	20.23	21.75
677	67.7	76.1	20.26	21.78
678	67.8	76.2	20.29	21.81
679	67.9	76.3	20.32	21.84
680	68.0	76.4	20.35	21.87
681	68.1	76.5	20.38	21.90
682	68.2	76.7	20.41	21.93
683	68.3	76.8	20.44	21.96
684	68.4	76.9	20.48	21.99
685	68.5	77.0	20.51	22.02
686	68.6	77.1	20.54	22.05
687	68.7	77.2	20.57	22.08
688	68.8	77.3	20.60	22.12
689	68.9	77.4	20.63	22.15
690	69.0	77.6	20.66	22.18
691	69.1	77.7	20.69	22.21
692	69.2	77.8	20.72	22.24
693	69.3	77.9	20.75	22.27
694	69.4	78.0	20.78	22.30
695	69.5	78.1	20.81	22.33
696	69.6	78.2	20.84	22.36
697	69.7	78.3	20.87	22.39
698	69.8	78.5	20.90	22.42
699	69.9	78.6	20.93	22.45
700	70.0	78.7	20.96	22.48
701	70.1	78.8	20.99	22.51
702	70.2	78.9	21.02	22.54
703	70.3	79.0	21.05	22.57
704	70.4	79.1	21.08	22.60

室内ユニット 合計容量	能力 (kW)		入力 (kW)	
	冷房	暖房	冷房	暖房
705	70.5	79.2	21.11	22.63
706	70.6	79.4	21.14	22.66
707	70.7	79.5	21.17	22.69
708	70.8	79.6	21.20	22.72
709	70.9	79.7	21.23	22.75
710	71.0	79.8	21.26	22.78
711	71.1	79.9	21.29	22.81
712	71.2	80.0	21.32	22.84
713	71.3	80.1	21.35	22.87
714	71.4	80.3	21.38	22.90
715	71.5	80.4	21.41	22.93
716	71.6	80.5	21.44	22.96
717	71.7	80.6	21.47	22.99
718	71.8	80.7	21.50	23.02
719	71.9	80.8	21.53	23.05
720	72.0	80.9	21.56	23.08
721	72.1	81.0	21.58	23.11
722	72.2	81.2	21.61	23.14
723	72.3	81.3	21.64	23.17
724	72.4	81.4	21.67	23.20
725	72.5	81.5	21.70	23.23
726	72.6	81.6	21.73	23.26
727	72.7	81.7	21.76	23.29
728	72.8	81.8	21.79	23.32
729	72.9	81.9	21.82	23.35
730	73.0	82.1	21.85	23.38
731	73.1	82.2	21.88	23.41
732	73.2	82.3	21.91	23.44
733	73.3	82.4	21.94	23.47
734	73.4	82.5	21.96	23.49
735	73.5	82.6	21.99	23.52
736	73.6	82.7	22.02	23.55
737	73.7	82.8	22.05	23.58
738	73.8	83.0	22.08	23.61
739	73.9	83.1	22.11	23.64
740	74.0	83.2	22.14	23.67
741	74.1	83.3	22.17	23.70
742	74.2	83.4	22.20	23.73
743	74.3	83.5	22.22	23.76
744	74.4	83.6	22.25	23.79
745	74.5	83.7	22.28	23.82
746	74.6	83.9	22.31	23.84
747	74.7	84.0	22.34	23.87
748	74.8	84.1	22.37	23.90
749	74.9	84.2	22.40	23.93
750	75.0	84.3	22.43	23.96
751	75.1	84.4	22.45	23.99
752	75.2	84.5	22.48	24.02
753	75.3	84.6	22.51	24.05
754	75.4	84.7	22.54	24.07
755	75.5	84.9	22.57	24.10
756	75.6	85.0	22.60	24.13
757	75.7	85.1	22.62	24.16
758	75.8	85.2	22.65	24.19
759	75.9	85.3	22.68	24.22
760	76.0	85.4	22.71	24.25
761	76.1	85.5	22.74	24.27
762	76.2	85.6	22.77	24.30
763	76.3	85.8	22.79	24.33
764	76.4	85.9	22.82	24.36
765	76.5	86.0	22.85	24.39
766	76.6	86.1	22.88	24.42
767	76.7	86.2	22.91	24.44
768	76.8	86.3	22.93	24.47
769	76.9	86.4	22.96	24.50
770	77.0	86.5	22.99	24.53
771	77.1	86.7	23.02	24.56
772	77.2	86.8	23.05	24.59
773	77.3	86.9	23.07	24.61
774	77.4	87.0	23.10	24.64

【PUHY-P1130SKM-E】

室内ユニット 合計容量	能力 (kW)		入力 (kW)	
	冷房	暖房	冷房	暖房
775	77.5	87.1	23.13	24.67
776	77.6	87.2	23.16	24.70
777	77.7	87.3	23.19	24.73
778	77.8	87.4	23.21	24.75
779	77.9	87.6	23.24	24.78
780	78.0	87.7	23.27	24.81
781	78.1	87.8	23.30	24.84
782	78.2	87.9	23.32	24.86
783	78.3	88.0	23.35	24.89
784	78.4	88.1	23.38	24.92
785	78.5	88.2	23.41	24.95
786	78.6	88.3	23.43	24.98
787	78.7	88.5	23.46	25.00
788	78.8	88.6	23.49	25.03
789	78.9	88.7	23.52	25.06
790	79.0	88.8	23.54	25.09
791	79.1	88.9	23.57	25.11
792	79.2	89.0	23.60	25.14
793	79.3	89.1	23.63	25.17
794	79.4	89.2	23.65	25.20
795	79.5	89.4	23.68	25.22
796	79.6	89.5	23.71	25.25
797	79.7	89.6	23.73	25.28
798	79.8	89.7	23.76	25.31
799	79.9	89.8	23.79	25.33
800	80.0	89.9	23.82	25.36
801	80.1	90.0	23.84	25.39
802	80.2	90.1	23.87	25.41
803	80.3	90.3	23.90	25.44
804	80.4	90.4	23.92	25.47
805	80.5	90.5	23.95	25.50
806	80.6	90.6	23.98	25.52
807	80.7	90.7	24.00	25.55
808	80.8	90.8	24.03	25.58
809	80.9	90.9	24.06	25.60
810	81.0	91.0	24.09	25.63
811	81.1	91.2	24.11	25.66
812	81.2	91.3	24.14	25.68
813	81.3	91.4	24.17	25.71
814	81.4	91.5	24.19	25.74
815	81.5	91.6	24.22	25.77
816	81.6	91.7	24.25	25.79
817	81.7	91.8	24.27	25.82
818	81.8	91.9	24.30	25.85
819	81.9	92.1	24.32	25.87
820	82.0	92.2	24.35	25.90
821	82.1	92.3	24.38	25.93
822	82.2	92.4	24.40	25.95
823	82.3	92.5	24.43	25.98
824	82.4	92.6	24.46	26.01
825	82.5	92.7	24.48	26.03
826	82.6	92.8	24.51	26.06
827	82.7	93.0	24.54	26.08
828	82.8	93.1	24.56	26.11
829	82.9	93.2	24.59	26.14
830	83.0	93.3	24.61	26.16
831	83.1	93.4	24.64	26.19
832	83.2	93.5	24.67	26.22
833	83.3	93.6	24.69	26.24
834	83.4	93.7	24.72	26.27
835	83.5	93.9	24.74	26.30
836	83.6	94.0	24.77	26.32
837	83.7	94.1	24.80	26.35
838	83.8	94.2	24.82	26.37
839	83.9	94.3	24.85	26.40
840	84.0	94.4	24.87	26.43
841	84.1	94.5	24.90	26.45
842	84.2	94.6	24.93	26.48
843	84.3	94.8	24.95	26.50
844	84.4	94.9	24.98	26.53

室内ユニット 合計容量	能力 (kW)		入力 (kW)	
	冷房	暖房	冷房	暖房
845	84.5	95.0	25.00	26.56
846	84.6	95.1	25.03	26.58
847	84.7	95.2	25.05	26.61
848	84.8	95.3	25.08	26.63
849	84.9	95.4	25.11	26.66
850	85.0	95.5	25.13	26.68
851	85.1	95.7	25.16	26.71
852	85.2	95.8	25.18	26.74
853	85.3	95.9	25.21	26.76
854	85.4	96.0	25.23	26.79
855	85.5	96.1	25.26	26.81
856	85.6	96.2	25.28	26.84
857	85.7	96.3	25.31	26.86
858	85.8	96.4	25.34	26.89
859	85.9	96.6	25.36	26.91
860	86.0	96.7	25.39	26.94
861	86.1	96.8	25.41	26.97
862	86.2	96.9	25.44	26.99
863	86.3	97.0	25.46	27.02
864	86.4	97.1	25.49	27.04
865	86.5	97.2	25.51	27.07
866	86.6	97.3	25.54	27.09
867	86.7	97.5	25.56	27.12
868	86.8	97.6	25.59	27.14
869	86.9	97.7	25.61	27.17
870	87.0	97.8	25.64	27.19
871	87.1	97.9	25.66	27.22
872	87.2	98.0	25.69	27.24
873	87.3	98.1	25.71	27.27
874	87.4	98.2	25.74	27.29
875	87.5	98.4	25.76	27.32
876	87.6	98.5	25.79	27.34
877	87.7	98.6	25.81	27.37
878	87.8	98.7	25.84	27.39
879	87.9	98.8	25.86	27.42
880	88.0	98.9	25.88	27.44
881	88.1	99.0	25.91	27.47
882	88.2	99.1	25.93	27.49
883	88.3	99.2	25.96	27.52
884	88.4	99.4	25.98	27.54
885	88.5	99.5	26.01	27.57
886	88.6	99.6	26.03	27.59
887	88.7	99.7	26.06	27.61
888	88.8	99.8	26.08	27.64
889	88.9	99.9	26.11	27.66
890	89.0	100.0	26.13	27.69
891	89.1	100.1	26.15	27.71
892	89.2	100.3	26.18	27.74
893	89.3	100.4	26.20	27.76
894	89.4	100.5	26.23	27.79
895	89.5	100.6	26.25	27.81
896	89.6	100.7	26.28	27.83
897	89.7	100.8	26.30	27.86
898	89.8	100.9	26.32	27.88
899	89.9	101.0	26.35	27.91
900	90.0	101.2	26.37	27.93
901	90.1	101.3	26.40	27.96
902	90.2	101.4	26.42	27.98
903	90.3	101.5	26.44	28.00
904	90.4	101.6	26.47	28.03
905	90.5	101.7	26.49	28.05
906	90.6	101.8	26.52	28.08
907	90.7	101.9	26.54	28.10
908	90.8	102.1	26.56	28.12
909	90.9	102.2	26.59	28.15
910	91.0	102.3	26.61	28.17
911	91.1	102.4	26.63	28.20
912	91.2	102.5	26.66	28.22
913	91.3	102.6	26.68	28.24
914	91.4	102.7	26.71	28.27

室内ユニット 合計容量	能力 (kW)		入力 (kW)	
	冷房	暖房	冷房	暖房
915	91.5	102.8	26.73	28.29
916	91.6	103.0	26.75	28.31
917	91.7	103.1	26.78	28.34
918	91.8	103.2	26.80	28.36
919	91.9	103.3	26.82	28.39
920	92.0	103.4	26.85	28.41
921	92.1	103.5	26.87	28.43
922	92.2	103.6	26.89	28.46
923	92.3	103.7	26.92	28.48
924	92.4	103.9	26.94	28.50
925	92.5	104.0	26.96	28.53
926	92.6	104.1	26.99	28.55
927	92.7	104.2	27.01	28.57
928	92.8	104.3	27.03	28.60
929	92.9	104.4	27.06	28.62
930	93.0	104.5	27.08	28.64
931	93.1	104.6	27.10	28.67
932	93.2	104.8	27.13	28.69
933	93.3	104.9	27.15	28.71
934	93.4	105.0	27.17	28.74
935	93.5	105.1	27.20	28.76
936	93.6	105.2	27.22	28.78
937	93.7	105.3	27.24	28.80
938	93.8	105.4	27.26	28.83
939	93.9	105.5	27.29	28.85
940	94.0	105.7	27.31	28.87
941	94.1	105.8	27.33	28.90
942	94.2	105.9	27.36	28.92
943	94.3	106.0	27.38	28.94
944	94.4	106.1	27.40	28.97
945	94.5	106.2	27.42	28.99
946	94.6	106.3	27.45	29.01
947	94.7	106.4	27.47	29.03
948	94.8	106.6	27.49	29.06
949	94.9	106.7	27.51	29.08
950	95.0	106.8	27.54	29.10
951	95.1	106.9	27.56	29.12
952	95.2	107.0	27.58	29.15
953	95.3	107.1	27.61	29.17
954	95.4	107.2	27.63	29.19
955	95.5	107.3	27.65	29.21
956	95.6	107.5	27.67	29.24
957	95.7	107.6	27.69	29.26
958	95.8	107.7	27.72	29.28
959	95.9	107.8	27.74	29.30
960	96.0	107.9	27.76	29.33
961	96.1	108.0	27.78	29.35
962	96.2	108.1	27.81	29.37
963	96.3	108.2	27.83	29.39
964	96.4	108.4	27.85	29.42
965	96.5	108.5	27.87	29.44
966	96.6	108.6	27.89	29.46
967	96.7	108.7	27.92	29.48
968	96.8	108.8	27.94	29.50
969	96.9	108.9	27.96	29.53
970	97.0	109.0	27.98	29.55
971	97.1	109.1	28.00	29.57
972	97.2	109.3	28.03	29.59
973	97.3	109.4	28.05	29.61
974	97.4	109.5	28.07	29.64
975	97.5	109.6	28.09	29.66
976	97.6	109.7	28.11	29.68
977	97.7	109.8	28.14	29.70
978	97.8	109.9	28.16	29.72
979	97.9	110.0	28.18	29.75
980	98.0	110.2	28.20	29.77
981	98.1	110.3	28.22	29.79
982	98.2	110.4	28.24	29.81
983	98.3	110.5	28.27	29.83
984	98.4	110.6	28.29	29.85



【PUHY-P1130SKM-E】

室内ユニット 合計容量	能力 (kW)		入力 (kW)	
	冷房	暖房	冷房	暖房
985	98.5	110.7	28.31	29.88
986	98.6	110.8	28.33	29.90
987	98.7	110.9	28.35	29.92
988	98.8	111.1	28.37	29.94
989	98.9	111.2	28.39	29.96
990	99.0	111.3	28.42	29.98
991	99.1	111.4	28.44	30.00
992	99.2	111.5	28.46	30.03
993	99.3	111.6	28.48	30.05
994	99.4	111.7	28.50	30.07
995	99.5	111.8	28.52	30.09
996	99.6	112.0	28.54	30.11
997	99.7	112.1	28.56	30.13
998	99.8	112.2	28.59	30.15
999	99.9	112.3	28.61	30.17
1000	100.0	112.4	28.63	30.20
1001	100.1	112.5	28.65	30.22
1002	100.2	112.6	28.67	30.24
1003	100.3	112.7	28.69	30.26
1004	100.4	112.8	28.71	30.28
1005	100.5	113.0	28.73	30.30
1006	100.6	113.1	28.75	30.32
1007	100.7	113.2	28.77	30.34
1008	100.8	113.3	28.80	30.36
1009	100.9	113.4	28.82	30.38
1010	101.0	113.5	28.84	30.40
1011	101.1	113.6	28.86	30.43
1012	101.2	113.7	28.88	30.45
1013	101.3	113.9	28.90	30.47
1014	101.4	114.0	28.92	30.49
1015	101.5	114.1	28.94	30.51
1016	101.6	114.2	28.96	30.53
1017	101.7	114.3	28.98	30.55
1018	101.8	114.4	29.00	30.57
1019	101.9	114.5	29.02	30.59
1020	102.0	114.6	29.04	30.61
1021	102.1	114.8	29.06	30.63
1022	102.2	114.9	29.08	30.65
1023	102.3	115.0	29.10	30.67
1024	102.4	115.1	29.12	30.69
1025	102.5	115.2	29.15	30.71
1026	102.6	115.3	29.17	30.73
1027	102.7	115.4	29.19	30.75
1028	102.8	115.5	29.21	30.77
1029	102.9	115.7	29.23	30.79
1030	103.0	115.8	29.25	30.81
1031	103.1	115.9	29.27	30.83
1032	103.2	116.0	29.29	30.85
1033	103.3	116.1	29.31	30.87
1034	103.4	116.2	29.33	30.89
1035	103.5	116.3	29.35	30.91
1036	103.6	116.4	29.37	30.93
1037	103.7	116.6	29.39	30.95
1038	103.8	116.7	29.41	30.97
1039	103.9	116.8	29.43	30.99
1040	104.0	116.9	29.45	31.01
1041	104.1	117.0	29.47	31.03
1042	104.2	117.1	29.49	31.05
1043	104.3	117.2	29.51	31.07
1044	104.4	117.3	29.53	31.09
1045	104.5	117.5	29.55	31.11
1046	104.6	117.6	29.57	31.13
1047	104.7	117.7	29.58	31.15
1048	104.8	117.8	29.60	31.17
1049	104.9	117.9	29.62	31.19
1050	105.0	118.0	29.64	31.21
1051	105.1	118.1	29.66	31.23
1052	105.2	118.2	29.68	31.25
1053	105.3	118.4	29.70	31.27
1054	105.4	118.5	29.72	31.29

室内ユニット 合計容量	能力 (kW)		入力 (kW)	
	冷房	暖房	冷房	暖房
1055	105.5	118.6	29.74	31.31
1056	105.6	118.7	29.76	31.33
1057	105.7	118.8	29.78	31.35
1058	105.8	118.9	29.80	31.37
1059	105.9	119.0	29.82	31.39
1060	106.0	119.1	29.84	31.41
1061	106.1	119.3	29.86	31.42
1062	106.2	119.4	29.88	31.44
1063	106.3	119.5	29.90	31.46
1064	106.4	119.6	29.91	31.48
1065	106.5	119.7	29.93	31.50
1066	106.6	119.8	29.95	31.52
1067	106.7	119.9	29.97	31.54
1068	106.8	120.0	29.99	31.56
1069	106.9	120.2	30.01	31.58
1070	107.0	120.3	30.03	31.60
1071	107.1	120.4	30.05	31.62
1072	107.2	120.5	30.07	31.63
1073	107.3	120.6	30.09	31.65
1074	107.4	120.7	30.10	31.67
1075	107.5	120.8	30.12	31.69
1076	107.6	120.9	30.14	31.71
1077	107.7	121.1	30.16	31.73
1078	107.8	121.2	30.18	31.75
1079	107.9	121.3	30.20	31.77
1080	108.0	121.4	30.22	31.78
1081	108.1	121.5	30.24	31.80
1082	108.2	121.6	30.25	31.82
1083	108.3	121.7	30.27	31.84
1084	108.4	121.8	30.29	31.86
1085	108.5	122.0	30.31	31.88
1086	108.6	122.1	30.33	31.90
1087	108.7	122.2	30.35	31.91
1088	108.8	122.3	30.37	31.93
1089	108.9	122.4	30.38	31.95
1090	109.0	122.5	30.40	31.97
1091	109.1	122.6	30.42	31.99
1092	109.2	122.7	30.44	32.01
1093	109.3	122.9	30.46	32.02
1094	109.4	123.0	30.48	32.04
1095	109.5	123.1	30.49	32.06
1096	109.6	123.2	30.51	32.08
1097	109.7	123.3	30.53	32.10
1098	109.8	123.4	30.55	32.12
1099	109.9	123.5	30.57	32.13
1100	110.0	123.6	30.58	32.15
1101	110.1	123.8	30.60	32.17
1102	110.2	123.9	30.62	32.19
1103	110.3	124.0	30.64	32.21
1104	110.4	124.1	30.66	32.22
1105	110.5	124.2	30.67	32.24
1106	110.6	124.3	30.69	32.26
1107	110.7	124.4	30.71	32.28
1108	110.8	124.5	30.73	32.29
1109	110.9	124.7	30.75	32.31
1110	111.0	124.8	30.76	32.33
1111	111.1	124.9	30.78	32.35
1112	111.2	125.0	30.80	32.37
1113	111.3	125.1	30.82	32.38
1114	111.4	125.2	30.83	32.40
1115	111.5	125.3	30.85	32.42
1116	111.6	125.4	30.87	32.44
1117	111.7	125.6	30.89	32.45
1118	111.8	125.7	30.90	32.47
1119	111.9	125.8	30.92	32.49
1120	112.0	125.9	30.94	32.51
1121	112.1	126.0	30.96	32.52
1122	112.2	126.1	30.97	32.54
1123	112.3	126.2	30.99	32.56
1124	112.4	126.3	31.01	32.58

室内ユニット 合計容量	能力 (kW)		入力 (kW)	
	冷房	暖房	冷房	暖房
1125	112.5	126.5	31.03	32.59
1126	112.6	126.6	31.04	32.61
1127	112.7	126.7	31.06	32.63
1128	112.8	126.8	31.08	32.64
1129	112.9	126.9	31.10	32.66
1130	113.0	127.0	31.11	32.68
1131	113.0	127.0	31.11	32.68
1132	113.1	127.0	31.11	32.67
1133	113.1	127.0	31.12	32.66
1134	113.1	127.0	31.12	32.65
1135	113.1	127.0	31.12	32.65
1136	113.2	127.0	31.12	32.64
1137	113.2	127.0	31.12	32.63
1138	113.2	127.0	31.13	32.62
1139	113.2	127.0	31.13	32.62
1140	113.2	127.1	31.13	32.61
1141	113.3	127.1	31.13	32.60
1142	113.3	127.1	31.13	32.59
1143	113.3	127.1	31.13	32.59
1144	113.3	127.1	31.14	32.58
1145	113.4	127.1	31.14	32.57
1146	113.4	127.1	31.14	32.56
1147	113.4	127.1	31.14	32.56
1148	113.4	127.1	31.14	32.55
1149	113.5	127.1	31.15	32.54
1150	113.5	127.1	31.15	32.53
1151	113.5	127.1	31.15	32.52
1152	113.5	127.1	31.15	32.52
1153	113.6	127.1	31.15	32.51
1154	113.6	127.1	31.16	32.50
1155	113.6	127.1	31.16	32.49
1156	113.6	127.2	31.16	32.49
1157	113.7	127.2	31.16	32.48
1158	113.7	127.2	31.16	32.47
1159	113.7	127.2	31.17	32.46
1160	113.7	127.2	31.17	32.46
1161	113.8	127.2	31.17	32.45
1162	113.8	127.2	31.17	32.44
1163	113.8	127.2	31.17	32.43
1164	113.8	127.2	31.18	32.43
1165	113.8	127.2	31.18	32.42
1166	113.9	127.2	31.18	32.41
1167	113.9	127.2	31.18	32.40
1168	113.9	127.2	31.18	32.40
1169	113.9	127.2	31.19	32.39
1170	114.0	127.2	31.19	32.38
1171	114.0	127.2	31.19	32.37
1172	114.0	127.2	31.19	32.37
1173	114.0	127.3	31.19	32.36
1174	114.1	127.3	31.20	32.35
1175	114.1	127.3	31.20	32.34
1176	114.1	127.3	31.20	32.34
1177	114.1	127.3	31.20	32.33
1178	114.2	127.3	31.20	32.32
1179	114.2	127.3	31.21	32.31
1180	114.2	127.3	31.21	32.31
1181	114.2	127.3	31.21	32.30
1182	114.3	127.3	31.21	32.29
1183	114.3	127.3	31.21	32.28
1184	114.3	127.3	31.22	32.28
1185	114.3	127.3	31.22	32.27
1186	114.4	127.3	31.22	32.26
1187	114.4	127.3	31.22	32.25
1188	114.4	127.3	31.22	32.25
1189	114.4	127.3	31.23	32.24
1190	114.5	127.4	31.23	32.23
1191	114.5	127.4	31.23	32.22
1192	114.5	127.4	31.23	32.22
1193	114.5	127.4	31.23	32.21
1194	114.5	127.4	31.24	32.20

### 【PUHY-P1130SKM-E】

室内ユニット 合計容量	能力 (kW)		入力 (kW)	
	冷房	暖房	冷房	暖房
1195	114.6	127.4	31.24	32.19
1196	114.6	127.4	31.24	32.19
1197	114.6	127.4	31.24	32.18
1198	114.6	127.4	31.24	32.17
1199	114.7	127.4	31.24	32.16
1200	114.7	127.4	31.25	32.16
1201	114.7	127.4	31.25	32.15
1202	114.7	127.4	31.25	32.14
1203	114.8	127.4	31.25	32.13
1204	114.8	127.4	31.25	32.13
1205	114.8	127.4	31.26	32.12
1206	114.8	127.4	31.26	32.11
1207	114.9	127.5	31.26	32.10
1208	114.9	127.5	31.26	32.10
1209	114.9	127.5	31.26	32.09
1210	114.9	127.5	31.27	32.08
1211	115.0	127.5	31.27	32.07
1212	115.0	127.5	31.27	32.07
1213	115.0	127.5	31.27	32.06
1214	115.0	127.5	31.27	32.05
1215	115.1	127.5	31.28	32.04
1216	115.1	127.5	31.28	32.04
1217	115.1	127.5	31.28	32.03
1218	115.1	127.5	31.28	32.02
1219	115.1	127.5	31.28	32.01
1220	115.2	127.5	31.29	32.00
1221	115.2	127.5	31.29	32.00
1222	115.2	127.5	31.29	31.99
1223	115.2	127.5	31.29	31.98
1224	115.3	127.6	31.29	31.97
1225	115.3	127.6	31.30	31.97
1226	115.3	127.6	31.30	31.96
1227	115.3	127.6	31.30	31.95
1228	115.4	127.6	31.30	31.94
1229	115.4	127.6	31.30	31.94
1230	115.4	127.6	31.31	31.93
1231	115.4	127.6	31.31	31.92
1232	115.5	127.6	31.31	31.91
1233	115.5	127.6	31.31	31.91
1234	115.5	127.6	31.31	31.90
1235	115.5	127.6	31.32	31.89
1236	115.6	127.6	31.32	31.88
1237	115.6	127.6	31.32	31.88
1238	115.6	127.6	31.32	31.87
1239	115.6	127.6	31.32	31.86
1240	115.7	127.6	31.33	31.85
1241	115.7	127.7	31.33	31.85
1242	115.7	127.7	31.33	31.84
1243	115.7	127.7	31.33	31.83
1244	115.8	127.7	31.33	31.82
1245	115.8	127.7	31.34	31.82
1246	115.8	127.7	31.34	31.81
1247	115.8	127.7	31.34	31.80
1248	115.8	127.7	31.34	31.79
1249	115.9	127.7	31.34	31.79
1250	115.9	127.7	31.35	31.78
1251	115.9	127.7	31.35	31.77
1252	115.9	127.7	31.35	31.76
1253	116.0	127.7	31.35	31.76
1254	116.0	127.7	31.35	31.75
1255	116.0	127.7	31.35	31.74
1256	116.0	127.7	31.36	31.73
1257	116.1	127.7	31.36	31.73
1258	116.1	127.8	31.36	31.72
1259	116.1	127.8	31.36	31.71
1260	116.1	127.8	31.36	31.70
1261	116.2	127.8	31.37	31.70
1262	116.2	127.8	31.37	31.69
1263	116.2	127.8	31.37	31.68
1264	116.2	127.8	31.37	31.67

室内ユニット 合計容量	能力 (kW)		入力 (kW)	
	冷房	暖房	冷房	暖房
1265	116.3	127.8	31.37	31.67
1266	116.3	127.8	31.38	31.66
1267	116.3	127.8	31.38	31.65
1268	116.3	127.8	31.38	31.64
1269	116.4	127.8	31.38	31.64
1270	116.4	127.8	31.38	31.63
1271	116.4	127.8	31.39	31.62
1272	116.4	127.8	31.39	31.61
1273	116.4	127.8	31.39	31.61
1274	116.5	127.8	31.39	31.60
1275	116.5	127.9	31.39	31.59
1276	116.5	127.9	31.40	31.58
1277	116.5	127.9	31.40	31.58
1278	116.6	127.9	31.40	31.57
1279	116.6	127.9	31.40	31.56
1280	116.6	127.9	31.40	31.55
1281	116.6	127.9	31.41	31.55
1282	116.7	127.9	31.41	31.54
1283	116.7	127.9	31.41	31.53
1284	116.7	127.9	31.41	31.52
1285	116.7	127.9	31.41	31.51
1286	116.8	127.9	31.42	31.51
1287	116.8	127.9	31.42	31.50
1288	116.8	127.9	31.42	31.49
1289	116.8	127.9	31.42	31.48
1290	116.9	127.9	31.42	31.48
1291	116.9	128.0	31.43	31.47
1292	116.9	128.0	31.43	31.46
1293	116.9	128.0	31.43	31.45
1294	117.0	128.0	31.43	31.45
1295	117.0	128.0	31.43	31.44
1296	117.0	128.0	31.44	31.43
1297	117.0	128.0	31.44	31.42
1298	117.0	128.0	31.44	31.42
1299	117.1	128.0	31.44	31.41
1300	117.1	128.0	31.44	31.40
1301	117.1	128.0	31.45	31.39
1302	117.1	128.0	31.45	31.39
1303	117.2	128.0	31.45	31.38
1304	117.2	128.0	31.45	31.37
1305	117.2	128.0	31.45	31.36
1306	117.2	128.0	31.45	31.36
1307	117.3	128.0	31.46	31.35
1308	117.3	128.1	31.46	31.34
1309	117.3	128.1	31.46	31.33
1310	117.3	128.1	31.46	31.33
1311	117.4	128.1	31.46	31.32
1312	117.4	128.1	31.47	31.31
1313	117.4	128.1	31.47	31.30
1314	117.4	128.1	31.47	31.30
1315	117.5	128.1	31.47	31.29
1316	117.5	128.1	31.47	31.28
1317	117.5	128.1	31.48	31.27
1318	117.5	128.1	31.48	31.27
1319	117.6	128.1	31.48	31.26
1320	117.6	128.1	31.48	31.25
1321	117.6	128.1	31.48	31.24
1322	117.6	128.1	31.49	31.24
1323	117.7	128.1	31.49	31.23
1324	117.7	128.1	31.49	31.22
1325	117.7	128.2	31.49	31.21
1326	117.7	128.2	31.49	31.21
1327	117.7	128.2	31.50	31.20
1328	117.8	128.2	31.50	31.19
1329	117.8	128.2	31.50	31.18
1330	117.8	128.2	31.50	31.18
1331	117.8	128.2	31.50	31.17
1332	117.9	128.2	31.51	31.16
1333	117.9	128.2	31.51	31.15
1334	117.9	128.2	31.51	31.15

室内ユニット 合計容量	能力 (kW)		入力 (kW)	
	冷房	暖房	冷房	暖房
1335	117.9	128.2	31.51	31.14
1336	118.0	128.2	31.51	31.13
1337	118.0	128.2	31.52	31.12
1338	118.0	128.2	31.52	31.12
1339	118.0	128.2	31.52	31.11
1340	118.1	128.2	31.52	31.10
1341	118.1	128.2	31.52	31.09
1342	118.1	128.3	31.53	31.09
1343	118.1	128.3	31.53	31.08
1344	118.2	128.3	31.53	31.07
1345	118.2	128.3	31.53	31.06
1346	118.2	128.3	31.53	31.06
1347	118.2	128.3	31.54	31.05
1348	118.3	128.3	31.54	31.04
1349	118.3	128.3	31.54	31.03
1350	118.3	128.3	31.54	31.03
1351	118.3	128.3	31.54	31.02
1352	118.3	128.3	31.55	31.01
1353	118.4	128.3	31.55	31.00
1354	118.4	128.3	31.55	30.99
1355	118.4	128.3	31.55	30.99
1356	118.4	128.3	31.55	30.98
1357	118.5	128.3	31.56	30.97
1358	118.5	128.3	31.56	30.96
1359	118.5	128.4	31.56	30.96
1360	118.5	128.4	31.56	30.95
1361	118.6	128.4	31.56	30.94
1362	118.6	128.4	31.56	30.93
1363	118.6	128.4	31.57	30.93
1364	118.6	128.4	31.57	30.92
1365	118.7	128.4	31.57	30.91
1366	118.7	128.4	31.57	30.90
1367	118.7	128.4	31.57	30.90
1368	118.7	128.4	31.58	30.89
1369	118.8	128.4	31.58	30.88
1370	118.8	128.4	31.58	30.87
1371	118.8	128.4	31.58	30.87
1372	118.8	128.4	31.58	30.86
1373	118.9	128.4	31.59	30.85
1374	118.9	128.4	31.59	30.84
1375	118.9	128.4	31.59	30.84
1376	118.9	128.5	31.59	30.83
1377	119.0	128.5	31.59	30.82
1378	119.0	128.5	31.60	30.81
1379	119.0	128.5	31.60	30.81
1380	119.0	128.5	31.60	30.80
1381	119.0	128.5	31.60	30.79
1382	119.1	128.5	31.60	30.78
1383	119.1	128.5	31.61	30.78
1384	119.1	128.5	31.61	30.77
1385	119.1	128.5	31.61	30.76
1386	119.2	128.5	31.61	30.75
1387	119.2	128.5	31.61	30.75
1388	119.2	128.5	31.62	30.74
1389	119.2	128.5	31.62	30.73
1390	119.3	128.5	31.62	30.72
1391	119.3	128.5	31.62	30.72
1392	119.3	128.5	31.62	30.71
1393	119.3	128.6	31.63	30.70
1394	119.4	128.6	31.63	30.69
1395	119.4	128.6	31.63	30.69
1396	119.4	128.6	31.63	30.68
1397	119.4	128.6	31.63	30.67
1398	119.5	128.6	31.64	30.66
1399	119.5	128.6	31.64	30.66
1400	119.5	128.6	31.64	30.65
1401	119.5	128.6	31.64	30.64
1402	119.6	128.6	31.64	30.63
1403	119.6	128.6	31.65	30.63
1404	119.6	128.6	31.65	30.62

## 【PUHY-P1130SKM-E】

室内ユニット 合計容量	能力 (kW)		入力 (kW)	
	冷房	暖房	冷房	暖房
1405	119.6	128.6	31.65	30.61
1406	119.6	128.6	31.65	30.60
1407	119.7	128.6	31.65	30.60
1408	119.7	128.6	31.66	30.59
1409	119.7	128.6	31.66	30.58
1410	119.7	128.7	31.66	30.57
1411	119.8	128.7	31.66	30.57
1412	119.8	128.7	31.66	30.56
1413	119.8	128.7	31.67	30.55
1414	119.8	128.7	31.67	30.54
1415	119.9	128.7	31.67	30.54
1416	119.9	128.7	31.67	30.53
1417	119.9	128.7	31.67	30.52
1418	119.9	128.7	31.67	30.51
1419	120.0	128.7	31.68	30.50
1420	120.0	128.7	31.68	30.50
1421	120.0	128.7	31.68	30.49
1422	120.0	128.7	31.68	30.48
1423	120.1	128.7	31.68	30.47
1424	120.1	128.7	31.69	30.47
1425	120.1	128.7	31.69	30.46
1426	120.1	128.8	31.69	30.45
1427	120.2	128.8	31.69	30.44
1428	120.2	128.8	31.69	30.44
1429	120.2	128.8	31.70	30.43
1430	120.2	128.8	31.70	30.42
1431	120.2	128.8	31.70	30.41
1432	120.3	128.8	31.70	30.41
1433	120.3	128.8	31.70	30.40
1434	120.3	128.8	31.71	30.39
1435	120.3	128.8	31.71	30.38
1436	120.4	128.8	31.71	30.38
1437	120.4	128.8	31.71	30.37
1438	120.4	128.8	31.71	30.36
1439	120.4	128.8	31.72	30.35
1440	120.5	128.8	31.72	30.35
1441	120.5	128.8	31.72	30.34
1442	120.5	128.8	31.72	30.33
1443	120.5	128.9	31.72	30.32
1444	120.6	128.9	31.73	30.32
1445	120.6	128.9	31.73	30.31
1446	120.6	128.9	31.73	30.30
1447	120.6	128.9	31.73	30.29
1448	120.7	128.9	31.73	30.29
1449	120.7	128.9	31.74	30.28
1450	120.7	128.9	31.74	30.27
1451	120.7	128.9	31.74	30.26
1452	120.8	128.9	31.74	30.26
1453	120.8	128.9	31.74	30.25
1454	120.8	128.9	31.75	30.24
1455	120.8	128.9	31.75	30.23
1456	120.9	128.9	31.75	30.23
1457	120.9	128.9	31.75	30.22
1458	120.9	128.9	31.75	30.21
1459	120.9	128.9	31.76	30.20
1460	120.9	129.0	31.76	30.20
1461	121.0	129.0	31.76	30.19
1462	121.0	129.0	31.76	30.18
1463	121.0	129.0	31.76	30.17
1464	121.0	129.0	31.77	30.17
1465	121.1	129.0	31.77	30.16
1466	121.1	129.0	31.77	30.15
1467	121.1	129.0	31.77	30.14
1468	121.1	129.0	31.77	30.14
1469	121.2	129.0	31.78	30.13

【PUHY-P1180SKM-E】

室内ユニット 合計容量	能力 (kW)		入力 (kW)	
	冷房	暖房	冷房	暖房
590	59.0	66.0	17.29	18.81
591	59.1	66.1	17.32	18.84
592	59.2	66.2	17.36	18.87
593	59.3	66.3	17.39	18.91
594	59.4	66.4	17.42	18.94
595	59.5	66.6	17.45	18.97
596	59.6	66.7	17.49	19.00
597	59.7	66.8	17.52	19.04
598	59.8	66.9	17.55	19.07
599	59.9	67.0	17.58	19.10
600	60.0	67.1	17.61	19.14
601	60.1	67.2	17.65	19.17
602	60.2	67.3	17.68	19.20
603	60.3	67.5	17.71	19.24
604	60.4	67.6	17.74	19.27
605	60.5	67.7	17.78	19.30
606	60.6	67.8	17.81	19.34
607	60.7	67.9	17.84	19.37
608	60.8	68.0	17.87	19.40
609	60.9	68.1	17.90	19.43
610	61.0	68.2	17.94	19.47
611	61.1	68.3	17.97	19.50
612	61.2	68.5	18.00	19.53
613	61.3	68.6	18.03	19.57
614	61.4	68.7	18.06	19.60
615	61.5	68.8	18.10	19.63
616	61.6	68.9	18.13	19.66
617	61.7	69.0	18.16	19.70
618	61.8	69.1	18.19	19.73
619	61.9	69.2	18.22	19.76
620	62.0	69.4	18.26	19.79
621	62.1	69.5	18.29	19.83
622	62.2	69.6	18.32	19.86
623	62.3	69.7	18.35	19.89
624	62.4	69.8	18.38	19.92
625	62.5	69.9	18.41	19.96
626	62.6	70.0	18.45	19.99
627	62.7	70.1	18.48	20.02
628	62.8	70.3	18.51	20.05
629	62.9	70.4	18.54	20.09
630	63.0	70.5	18.57	20.12
631	63.1	70.6	18.60	20.15
632	63.2	70.7	18.64	20.18
633	63.3	70.8	18.67	20.22
634	63.4	70.9	18.70	20.25
635	63.5	71.0	18.73	20.28
636	63.6	71.1	18.76	20.31
637	63.7	71.3	18.79	20.34
638	63.8	71.4	18.83	20.38
639	63.9	71.5	18.86	20.41
640	64.0	71.6	18.89	20.44
641	64.1	71.7	18.92	20.47
642	64.2	71.8	18.95	20.50
643	64.3	71.9	18.98	20.54
644	64.4	72.0	19.02	20.57
645	64.5	72.2	19.05	20.60
646	64.6	72.3	19.08	20.63
647	64.7	72.4	19.11	20.66
648	64.8	72.5	19.14	20.70
649	64.9	72.6	19.17	20.73
650	65.0	72.7	19.20	20.76
651	65.1	72.8	19.24	20.79
652	65.2	72.9	19.27	20.82
653	65.3	73.0	19.30	20.86
654	65.4	73.2	19.33	20.89
655	65.5	73.3	19.36	20.92
656	65.6	73.4	19.39	20.95
657	65.7	73.5	19.42	20.98
658	65.8	73.6	19.45	21.01
659	65.9	73.7	19.49	21.05

室内ユニット 合計容量	能力 (kW)		入力 (kW)	
	冷房	暖房	冷房	暖房
660	66.0	73.8	19.52	21.08
661	66.1	73.9	19.55	21.11
662	66.2	74.1	19.58	21.14
663	66.3	74.2	19.61	21.17
664	66.4	74.3	19.64	21.20
665	66.5	74.4	19.67	21.24
666	66.6	74.5	19.70	21.27
667	66.7	74.6	19.73	21.30
668	66.8	74.7	19.77	21.33
669	66.9	74.8	19.80	21.36
670	67.0	74.9	19.83	21.39
671	67.1	75.1	19.86	21.42
672	67.2	75.2	19.89	21.46
673	67.3	75.3	19.92	21.49
674	67.4	75.4	19.95	21.52
675	67.5	75.5	19.98	21.55
676	67.6	75.6	20.01	21.58
677	67.7	75.7	20.04	21.61
678	67.8	75.8	20.08	21.64
679	67.9	76.0	20.11	21.67
680	68.0	76.1	20.14	21.71
681	68.1	76.2	20.17	21.74
682	68.2	76.3	20.20	21.77
683	68.3	76.4	20.23	21.80
684	68.4	76.5	20.26	21.83
685	68.5	76.6	20.29	21.86
686	68.6	76.7	20.32	21.89
687	68.7	76.9	20.35	21.92
688	68.8	77.0	20.38	21.95
689	68.9	77.1	20.41	21.98
690	69.0	77.2	20.45	22.02
691	69.1	77.3	20.48	22.05
692	69.2	77.4	20.51	22.08
693	69.3	77.5	20.54	22.11
694	69.4	77.6	20.57	22.14
695	69.5	77.7	20.60	22.17
696	69.6	77.9	20.63	22.20
697	69.7	78.0	20.66	22.23
698	69.8	78.1	20.69	22.26
699	69.9	78.2	20.72	22.29
700	70.0	78.3	20.75	22.32
701	70.1	78.4	20.78	22.35
702	70.2	78.5	20.81	22.38
703	70.3	78.6	20.84	22.42
704	70.4	78.8	20.87	22.45
705	70.5	78.9	20.90	22.48
706	70.6	79.0	20.93	22.51
707	70.7	79.1	20.96	22.54
708	70.8	79.2	20.99	22.57
709	70.9	79.3	21.03	22.60
710	71.0	79.4	21.06	22.63
711	71.1	79.5	21.09	22.66
712	71.2	79.6	21.12	22.69
713	71.3	79.8	21.15	22.72
714	71.4	79.9	21.18	22.75
715	71.5	80.0	21.21	22.78
716	71.6	80.1	21.24	22.81
717	71.7	80.2	21.27	22.84
718	71.8	80.3	21.30	22.87
719	71.9	80.4	21.33	22.90
720	72.0	80.5	21.36	22.93
721	72.1	80.7	21.39	22.96
722	72.2	80.8	21.42	22.99
723	72.3	80.9	21.45	23.02
724	72.4	81.0	21.48	23.05
725	72.5	81.1	21.51	23.08
726	72.6	81.2	21.54	23.11
727	72.7	81.3	21.57	23.14
728	72.8	81.4	21.60	23.17
729	72.9	81.5	21.63	23.20

室内ユニット 合計容量	能力 (kW)		入力 (kW)	
	冷房	暖房	冷房	暖房
730	73.0	81.7	21.66	23.23
731	73.1	81.8	21.69	23.26
732	73.2	81.9	21.72	23.29
733	73.3	82.0	21.75	23.32
734	73.4	82.1	21.78	23.35
735	73.5	82.2	21.81	23.38
736	73.6	82.3	21.84	23.41
737	73.7	82.4	21.87	23.44
738	73.8	82.6	21.90	23.47
739	73.9	82.7	21.93	23.50
740	74.0	82.8	21.96	23.53
741	74.1	82.9	21.99	23.56
742	74.2	83.0	22.02	23.59
743	74.3	83.1	22.05	23.62
744	74.4	83.2	22.08	23.65
745	74.5	83.3	22.11	23.68
746	74.6	83.5	22.14	23.71
747	74.7	83.6	22.17	23.74
748	74.8	83.7	22.20	23.77
749	74.9	83.8	22.23	23.80
750	75.0	83.9	22.26	23.83
751	75.1	84.0	22.29	23.86
752	75.2	84.1	22.32	23.88
753	75.3	84.2	22.35	23.91
754	75.4	84.3	22.38	23.94
755	75.5	84.5	22.41	23.97
756	75.6	84.6	22.43	24.00
757	75.7	84.7	22.46	24.03
758	75.8	84.8	22.49	24.06
759	75.9	84.9	22.52	24.09
760	76.0	85.0	22.55	24.12
761	76.1	85.1	22.58	24.15
762	76.2	85.2	22.61	24.18
763	76.3	85.4	22.64	24.21
764	76.4	85.5	22.67	24.24
765	76.5	85.6	22.70	24.26
766	76.6	85.7	22.73	24.29
767	76.7	85.8	22.76	24.32
768	76.8	85.9	22.79	24.35
769	76.9	86.0	22.82	24.38
770	77.0	86.1	22.85	24.41
771	77.1	86.2	22.88	24.44
772	77.2	86.4	22.91	24.47
773	77.3	86.5	22.94	24.50
774	77.4	86.6	22.96	24.52
775	77.5	86.7	22.99	24.55
776	77.6	86.8	23.02	24.58
777	77.7	86.9	23.05	24.61
778	77.8	87.0	23.08	24.64
779	77.9	87.1	23.11	24.67
780	78.0	87.3	23.14	24.70
781	78.1	87.4	23.17	24.73
782	78.2	87.5	23.20	24.75
783	78.3	87.6	23.23	24.78
784	78.4	87.7	23.26	24.81
785	78.5	87.8	23.29	24.84
786	78.6	87.9	23.31	24.87
787	78.7	88.0	23.34	24.90
788	78.8	88.1	23.37	24.93
789	78.9	88.3	23.40	24.95
790	79.0	88.4	23.43	24.98
791	79.1	88.5	23.46	25.01
792	79.2	88.6	23.49	25.04
793	79.3	88.7	23.52	25.07
794	79.4	88.8	23.55	25.10
795	79.5	88.9	23.58	25.13
796	79.6	89.0	23.61	25.15
797	79.7	89.2	23.63	25.18
798	79.8	89.3	23.66	25.21
799	79.9	89.4	23.69	25.24

【PUHY-P1180SKM-E】

室内ユニット 合計容量	能力 (kW)		入力 (kW)	
	冷房	暖房	冷房	暖房
800	80.0	89.5	23.72	25.27
801	80.1	89.6	23.75	25.30
802	80.2	89.7	23.78	25.32
803	80.3	89.8	23.81	25.35
804	80.4	89.9	23.84	25.38
805	80.5	90.1	23.86	25.41
806	80.6	90.2	23.89	25.44
807	80.7	90.3	23.92	25.46
808	80.8	90.4	23.95	25.49
809	80.9	90.5	23.98	25.52
810	81.0	90.6	24.01	25.55
811	81.1	90.7	24.04	25.58
812	81.2	90.8	24.07	25.60
813	81.3	90.9	24.09	25.63
814	81.4	91.1	24.12	25.66
815	81.5	91.2	24.15	25.69
816	81.6	91.3	24.18	25.72
817	81.7	91.4	24.21	25.74
818	81.8	91.5	24.24	25.77
819	81.9	91.6	24.27	25.80
820	82.0	91.7	24.29	25.83
821	82.1	91.8	24.32	25.85
822	82.2	92.0	24.35	25.88
823	82.3	92.1	24.38	25.91
824	82.4	92.2	24.41	25.94
825	82.5	92.3	24.44	25.96
826	82.6	92.4	24.47	25.99
827	82.7	92.5	24.49	26.02
828	82.8	92.6	24.52	26.05
829	82.9	92.7	24.55	26.08
830	83.0	92.8	24.58	26.10
831	83.1	93.0	24.61	26.13
832	83.2	93.1	24.64	26.16
833	83.3	93.2	24.66	26.18
834	83.4	93.3	24.69	26.21
835	83.5	93.4	24.72	26.24
836	83.6	93.5	24.75	26.27
837	83.7	93.6	24.78	26.29
838	83.8	93.7	24.81	26.32
839	83.9	93.9	24.83	26.35
840	84.0	94.0	24.86	26.38
841	84.1	94.1	24.89	26.40
842	84.2	94.2	24.92	26.43
843	84.3	94.3	24.95	26.46
844	84.4	94.4	24.97	26.49
845	84.5	94.5	25.00	26.51
846	84.6	94.6	25.03	26.54
847	84.7	94.7	25.06	26.57
848	84.8	94.9	25.09	26.59
849	84.9	95.0	25.11	26.62
850	85.0	95.1	25.14	26.65
851	85.1	95.2	25.17	26.67
852	85.2	95.3	25.20	26.70
853	85.3	95.4	25.23	26.73
854	85.4	95.5	25.25	26.76
855	85.5	95.6	25.28	26.78
856	85.6	95.8	25.31	26.81
857	85.7	95.9	25.34	26.84
858	85.8	96.0	25.37	26.86
859	85.9	96.1	25.39	26.89
860	86.0	96.2	25.42	26.92
861	86.1	96.3	25.45	26.94
862	86.2	96.4	25.48	26.97
863	86.3	96.5	25.51	27.00
864	86.4	96.7	25.53	27.02
865	86.5	96.8	25.56	27.05
866	86.6	96.9	25.59	27.08
867	86.7	97.0	25.62	27.10
868	86.8	97.1	25.64	27.13
869	86.9	97.2	25.67	27.16

室内ユニット 合計容量	能力 (kW)		入力 (kW)	
	冷房	暖房	冷房	暖房
870	87.0	97.3	25.70	27.18
871	87.1	97.4	25.73	27.21
872	87.2	97.5	25.75	27.24
873	87.3	97.7	25.78	27.26
874	87.4	97.8	25.81	27.29
875	87.5	97.9	25.84	27.32
876	87.6	98.0	25.87	27.34
877	87.7	98.1	25.89	27.37
878	87.8	98.2	25.92	27.39
879	87.9	98.3	25.95	27.42
880	88.0	98.4	25.98	27.45
881	88.1	98.6	26.00	27.47
882	88.2	98.7	26.03	27.50
883	88.3	98.8	26.06	27.53
884	88.4	98.9	26.09	27.55
885	88.5	99.0	26.11	27.58
886	88.6	99.1	26.14	27.60
887	88.7	99.2	26.17	27.63
888	88.8	99.3	26.20	27.66
889	88.9	99.4	26.22	27.68
890	89.0	99.6	26.25	27.71
891	89.1	99.7	26.28	27.73
892	89.2	99.8	26.30	27.76
893	89.3	99.9	26.33	27.79
894	89.4	100.0	26.36	27.81
895	89.5	100.1	26.39	27.84
896	89.6	100.2	26.41	27.86
897	89.7	100.3	26.44	27.89
898	89.8	100.5	26.47	27.92
899	89.9	100.6	26.50	27.94
900	90.0	100.7	26.52	27.97
901	90.1	100.8	26.55	27.99
902	90.2	100.9	26.58	28.02
903	90.3	101.0	26.60	28.04
904	90.4	101.1	26.63	28.07
905	90.5	101.2	26.66	28.10
906	90.6	101.3	26.69	28.12
907	90.7	101.5	26.71	28.15
908	90.8	101.6	26.74	28.17
909	90.9	101.7	26.77	28.20
910	91.0	101.8	26.79	28.22
911	91.1	101.9	26.82	28.25
912	91.2	102.0	26.85	28.28
913	91.3	102.1	26.87	28.30
914	91.4	102.2	26.90	28.33
915	91.5	102.4	26.93	28.35
916	91.6	102.5	26.96	28.38
917	91.7	102.6	26.98	28.40
918	91.8	102.7	27.01	28.43
919	91.9	102.8	27.04	28.45
920	92.0	102.9	27.06	28.48
921	92.1	103.0	27.09	28.50
922	92.2	103.1	27.12	28.53
923	92.3	103.3	27.14	28.55
924	92.4	103.4	27.17	28.58
925	92.5	103.5	27.20	28.61
926	92.6	103.6	27.22	28.63
927	92.7	103.7	27.25	28.66
928	92.8	103.8	27.28	28.68
929	92.9	103.9	27.30	28.71
930	93.0	104.0	27.33	28.73
931	93.1	104.1	27.36	28.76
932	93.2	104.3	27.38	28.78
933	93.3	104.4	27.41	28.81
934	93.4	104.5	27.44	28.83
935	93.5	104.6	27.46	28.86
936	93.6	104.7	27.49	28.88
937	93.7	104.8	27.52	28.91
938	93.8	104.9	27.54	28.93
939	93.9	105.0	27.57	28.96

室内ユニット 合計容量	能力 (kW)		入力 (kW)	
	冷房	暖房	冷房	暖房
940	94.0	105.2	27.60	28.98
941	94.1	105.3	27.62	29.00
942	94.2	105.4	27.65	29.03
943	94.3	105.5	27.68	29.05
944	94.4	105.6	27.70	29.08
945	94.5	105.7	27.73	29.10
946	94.6	105.8	27.76	29.13
947	94.7	105.9	27.78	29.15
948	94.8	106.0	27.81	29.18
949	94.9	106.2	27.83	29.20
950	95.0	106.3	27.86	29.23
951	95.1	106.4	27.89	29.25
952	95.2	106.5	27.91	29.28
953	95.3	106.6	27.94	29.30
954	95.4	106.7	27.97	29.33
955	95.5	106.8	27.99	29.35
956	95.6	106.9	28.02	29.37
957	95.7	107.1	28.04	29.40
958	95.8	107.2	28.07	29.42
959	95.9	107.3	28.10	29.45
960	96.0	107.4	28.12	29.47
961	96.1	107.5	28.15	29.50
962	96.2	107.6	28.18	29.52
963	96.3	107.7	28.20	29.54
964	96.4	107.8	28.23	29.57
965	96.5	107.9	28.25	29.59
966	96.6	108.1	28.28	29.62
967	96.7	108.2	28.31	29.64
968	96.8	108.3	28.33	29.67
969	96.9	108.4	28.36	29.69
970	97.0	108.5	28.38	29.71
971	97.1	108.6	28.41	29.74
972	97.2	108.7	28.44	29.76
973	97.3	108.8	28.46	29.79
974	97.4	109.0	28.49	29.81
975	97.5	109.1	28.51	29.83
976	97.6	109.2	28.54	29.86
977	97.7	109.3	28.57	29.88
978	97.8	109.4	28.59	29.91
979	97.9	109.5	28.62	29.93
980	98.0	109.6	28.64	29.95
981	98.1	109.7	28.67	29.98
982	98.2	109.9	28.70	30.00
983	98.3	110.0	28.72	30.03
984	98.4	110.1	28.75	30.05
985	98.5	110.2	28.77	30.07
986	98.6	110.3	28.80	30.10
987	98.7	110.4	28.82	30.12
988	98.8	110.5	28.85	30.14
989	98.9	110.6	28.88	30.17
990	99.0	110.7	28.90	30.19
991	99.1	110.9	28.93	30.21
992	99.2	111.0	28.95	30.24
993	99.3	111.1	28.98	30.26
994	99.4	111.2	29.00	30.29
995	99.5	111.3	29.03	30.31
996	99.6	111.4	29.05	30.33
997	99.7	111.5	29.08	30.36
998	99.8	111.6	29.11	30.38
999	99.9	111.8	29.13	30.40
1000	100.0	111.9	29.16	30.43
1001	100.1	112.0	29.18	30.45
1002	100.2	112.1	29.21	30.47
1003	100.3	112.2	29.23	30.50
1004	100.4	112.3	29.26	30.52
1005	100.5	112.4	29.28	30.54
1006	100.6	112.5	29.31	30.57
1007	100.7	112.6	29.34	30.59
1008	100.8	112.8	29.36	30.61
1009	100.9	112.9	29.39	30.64

**【PUHY-P1180SKM-E】**

室内ユニット 合計容量	能力 (kW)		入力 (kW)	
	冷房	暖房	冷房	暖房
1010	101.0	113.0	29.41	30.66
1011	101.1	113.1	29.44	30.68
1012	101.2	113.2	29.46	30.70
1013	101.3	113.3	29.49	30.73
1014	101.4	113.4	29.51	30.75
1015	101.5	113.5	29.54	30.77
1016	101.6	113.7	29.56	30.80
1017	101.7	113.8	29.59	30.82
1018	101.8	113.9	29.61	30.84
1019	101.9	114.0	29.64	30.87
1020	102.0	114.1	29.66	30.89
1021	102.1	114.2	29.69	30.91
1022	102.2	114.3	29.71	30.93
1023	102.3	114.4	29.74	30.96
1024	102.4	114.5	29.76	30.98
1025	102.5	114.7	29.79	31.00
1026	102.6	114.8	29.81	31.03
1027	102.7	114.9	29.84	31.05
1028	102.8	115.0	29.86	31.07
1029	102.9	115.1	29.89	31.09
1030	103.0	115.2	29.91	31.12
1031	103.1	115.3	29.94	31.14
1032	103.2	115.4	29.96	31.16
1033	103.3	115.6	29.99	31.18
1034	103.4	115.7	30.01	31.21
1035	103.5	115.8	30.04	31.23
1036	103.6	115.9	30.06	31.25
1037	103.7	116.0	30.09	31.27
1038	103.8	116.1	30.11	31.30
1039	103.9	116.2	30.14	31.32
1040	104.0	116.3	30.16	31.34
1041	104.1	116.5	30.19	31.36
1042	104.2	116.6	30.21	31.39
1043	104.3	116.7	30.24	31.41
1044	104.4	116.8	30.26	31.43
1045	104.5	116.9	30.29	31.45
1046	104.6	117.0	30.31	31.48
1047	104.7	117.1	30.34	31.50
1048	104.8	117.2	30.36	31.52
1049	104.9	117.3	30.39	31.54
1050	105.0	117.5	30.41	31.56
1051	105.1	117.6	30.44	31.59
1052	105.2	117.7	30.46	31.61
1053	105.3	117.8	30.49	31.63
1054	105.4	117.9	30.51	31.65
1055	105.5	118.0	30.53	31.67
1056	105.6	118.1	30.56	31.70
1057	105.7	118.2	30.58	31.72
1058	105.8	118.4	30.61	31.74
1059	105.9	118.5	30.63	31.76
1060	106.0	118.6	30.66	31.78
1061	106.1	118.7	30.68	31.81
1062	106.2	118.8	30.71	31.83
1063	106.3	118.9	30.73	31.85
1064	106.4	119.0	30.76	31.87
1065	106.5	119.1	30.78	31.89
1066	106.6	119.2	30.80	31.92
1067	106.7	119.4	30.83	31.94
1068	106.8	119.5	30.85	31.96
1069	106.9	119.6	30.88	31.98
1070	107.0	119.7	30.90	32.00
1071	107.1	119.8	30.93	32.02
1072	107.2	119.9	30.95	32.05
1073	107.3	120.0	30.97	32.07
1074	107.4	120.1	31.00	32.09
1075	107.5	120.3	31.02	32.11
1076	107.6	120.4	31.05	32.13
1077	107.7	120.5	31.07	32.15
1078	107.8	120.6	31.10	32.18
1079	107.9	120.7	31.12	32.20

室内ユニット 合計容量	能力 (kW)		入力 (kW)	
	冷房	暖房	冷房	暖房
1080	108.0	120.8	31.14	32.22
1081	108.1	120.9	31.17	32.24
1082	108.2	121.0	31.19	32.26
1083	108.3	121.1	31.22	32.28
1084	108.4	121.3	31.24	32.30
1085	108.5	121.4	31.26	32.32
1086	108.6	121.5	31.29	32.35
1087	108.7	121.6	31.31	32.37
1088	108.8	121.7	31.34	32.39
1089	108.9	121.8	31.36	32.41
1090	109.0	121.9	31.38	32.43
1091	109.1	122.0	31.41	32.45
1092	109.2	122.2	31.43	32.47
1093	109.3	122.3	31.46	32.49
1094	109.4	122.4	31.48	32.52
1095	109.5	122.5	31.50	32.54
1096	109.6	122.6	31.53	32.56
1097	109.7	122.7	31.55	32.58
1098	109.8	122.8	31.58	32.60
1099	109.9	122.9	31.60	32.62
1100	110.0	123.1	31.62	32.64
1101	110.1	123.2	31.65	32.66
1102	110.2	123.3	31.67	32.68
1103	110.3	123.4	31.70	32.70
1104	110.4	123.5	31.72	32.73
1105	110.5	123.6	31.74	32.75
1106	110.6	123.7	31.77	32.77
1107	110.7	123.8	31.79	32.79
1108	110.8	123.9	31.81	32.81
1109	110.9	124.1	31.84	32.83
1110	111.0	124.2	31.86	32.85
1111	111.1	124.3	31.89	32.87
1112	111.2	124.4	31.91	32.89
1113	111.3	124.5	31.93	32.91
1114	111.4	124.6	31.96	32.93
1115	111.5	124.7	31.98	32.95
1116	111.6	124.8	32.00	32.97
1117	111.7	125.0	32.03	32.99
1118	111.8	125.1	32.05	33.01
1119	111.9	125.2	32.07	33.04
1120	112.0	125.3	32.10	33.06
1121	112.1	125.4	32.12	33.08
1122	112.2	125.5	32.14	33.10
1123	112.3	125.6	32.17	33.12
1124	112.4	125.7	32.19	33.14
1125	112.5	125.8	32.21	33.16
1126	112.6	126.0	32.24	33.18
1127	112.7	126.1	32.26	33.20
1128	112.8	126.2	32.28	33.22
1129	112.9	126.3	32.31	33.24
1130	113.0	126.4	32.33	33.26
1131	113.1	126.5	32.35	33.28
1132	113.2	126.6	32.38	33.30
1133	113.3	126.7	32.40	33.32
1134	113.4	126.9	32.42	33.34
1135	113.5	127.0	32.45	33.36
1136	113.6	127.1	32.47	33.38
1137	113.7	127.2	32.49	33.40
1138	113.8	127.3	32.52	33.42
1139	113.9	127.4	32.54	33.44
1140	114.0	127.5	32.56	33.46
1141	114.1	127.6	32.59	33.48
1142	114.2	127.7	32.61	33.50
1143	114.3	127.9	32.63	33.52
1144	114.4	128.0	32.66	33.54
1145	114.5	128.1	32.68	33.56
1146	114.6	128.2	32.70	33.58
1147	114.7	128.3	32.73	33.60
1148	114.8	128.4	32.75	33.62
1149	114.9	128.5	32.77	33.64

室内ユニット 合計容量	能力 (kW)		入力 (kW)	
	冷房	暖房	冷房	暖房
1150	115.0	128.6	32.79	33.66
1151	115.1	128.8	32.82	33.68
1152	115.2	128.9	32.84	33.70
1153	115.3	129.0	32.86	33.72
1154	115.4	129.1	32.89	33.74
1155	115.5	129.2	32.91	33.76
1156	115.6	129.3	32.93	33.78
1157	115.7	129.4	32.96	33.80
1158	115.8	129.5	32.98	33.82
1159	115.9	129.7	33.00	33.84
1160	116.0	129.8	33.02	33.85
1161	116.1	129.9	33.05	33.87
1162	116.2	130.0	33.07	33.89
1163	116.3	130.1	33.09	33.91
1164	116.4	130.2	33.12	33.93
1165	116.5	130.3	33.14	33.95
1166	116.6	130.4	33.16	33.97
1167	116.7	130.5	33.18	33.99
1168	116.8	130.7	33.21	34.01
1169	116.9	130.8	33.23	34.03
1170	117.0	130.9	33.25	34.05
1171	117.1	131.0	33.27	34.07
1172	117.2	131.1	33.30	34.09
1173	117.3	131.2	33.32	34.11
1174	117.4	131.3	33.34	34.13
1175	117.5	131.4	33.36	34.14
1176	117.6	131.6	33.39	34.16
1177	117.7	131.7	33.41	34.18
1178	117.8	131.8	33.43	34.20
1179	117.9	131.9	33.45	34.22
1180	118.0	132.0	33.48	34.24
1181	118.0	132.0	33.48	34.23
1182	118.1	132.0	33.48	34.22
1183	118.1	132.0	33.49	34.22
1184	118.1	132.1	33.49	34.21
1185	118.1	132.1	33.49	34.20
1186	118.1	132.1	33.49	34.19
1187	118.2	132.1	33.49	34.18
1188	118.2	132.1	33.50	34.18
1189	118.2	132.1	33.50	34.17
1190	118.2	132.1	33.50	34.16
1191	118.3	132.1	33.50	34.15
1192	118.3	132.1	33.51	34.14
1193	118.3	132.1	33.51	34.14
1194	118.3	132.1	33.51	34.13
1195	118.4	132.1	33.51	34.12
1196	118.4	132.1	33.51	34.11
1197	118.4	132.1	33.52	34.10
1198	118.4	132.1	33.52	34.10
1199	118.5	132.2	33.52	34.09
1200	118.5	132.2	33.52	34.08
1201	118.5	132.2	33.53	34.07
1202	118.5	132.2	33.53	34.06
1203	118.6	132.2	33.53	34.06
1204	118.6	132.2	33.53	34.05
1205	118.6	132.2	33.53	34.04
1206	118.6	132.2	33.54	34.03
1207	118.7	132.2	33.54	34.02
1208	118.7	132.2	33.54	34.02
1209	118.7	132.2	33.54	34.01
1210	118.7	132.2	33.55	34.00
1211	118.8	132.2	33.55	33.99
1212	118.8	132.2	33.55	33.98
1213	118.8	132.2	33.55	33.98
1214	118.8	132.3	33.55	33.97
1215	118.8	132.3	33.56	33.96
1216	118.9	132.3	33.56	33.95
1217	118.9	132.3	33.56	33.94
1218	118.9	132.3	33.56	33.94
1219	118.9	132.3	33.57	33.93

## 【PUHY-P1180SKM-E】

室内ユニット 合計容量	能力 (kW)		入力 (kW)	
	冷房	暖房	冷房	暖房
1220	119.0	132.3	33.57	33.92
1221	119.0	132.3	33.57	33.91
1222	119.0	132.3	33.57	33.90
1223	119.0	132.3	33.57	33.90
1224	119.1	132.3	33.58	33.89
1225	119.1	132.3	33.58	33.88
1226	119.1	132.3	33.58	33.87
1227	119.1	132.3	33.58	33.86
1228	119.2	132.3	33.59	33.86
1229	119.2	132.4	33.59	33.85
1230	119.2	132.4	33.59	33.84
1231	119.2	132.4	33.59	33.83
1232	119.3	132.4	33.59	33.82
1233	119.3	132.4	33.60	33.82
1234	119.3	132.4	33.60	33.81
1235	119.3	132.4	33.60	33.80
1236	119.4	132.4	33.60	33.79
1237	119.4	132.4	33.61	33.78
1238	119.4	132.4	33.61	33.78
1239	119.4	132.4	33.61	33.77
1240	119.5	132.4	33.61	33.76
1241	119.5	132.4	33.61	33.75
1242	119.5	132.4	33.62	33.74
1243	119.5	132.4	33.62	33.74
1244	119.5	132.5	33.62	33.73
1245	119.6	132.5	33.62	33.72
1246	119.6	132.5	33.62	33.71
1247	119.6	132.5	33.63	33.71
1248	119.6	132.5	33.63	33.70
1249	119.7	132.5	33.63	33.69
1250	119.7	132.5	33.63	33.68
1251	119.7	132.5	33.64	33.67
1252	119.7	132.5	33.64	33.67
1253	119.8	132.5	33.64	33.66
1254	119.8	132.5	33.64	33.65
1255	119.8	132.5	33.64	33.64
1256	119.8	132.5	33.65	33.63
1257	119.9	132.5	33.65	33.63
1258	119.9	132.5	33.65	33.62
1259	119.9	132.6	33.65	33.61
1260	119.9	132.6	33.66	33.60
1261	120.0	132.6	33.66	33.59
1262	120.0	132.6	33.66	33.59
1263	120.0	132.6	33.66	33.58
1264	120.0	132.6	33.66	33.57
1265	120.1	132.6	33.67	33.56
1266	120.1	132.6	33.67	33.55
1267	120.1	132.6	33.67	33.55
1268	120.1	132.6	33.67	33.54
1269	120.2	132.6	33.68	33.53
1270	120.2	132.6	33.68	33.52
1271	120.2	132.6	33.68	33.51
1272	120.2	132.6	33.68	33.51
1273	120.2	132.7	33.68	33.50
1274	120.3	132.7	33.69	33.49
1275	120.3	132.7	33.69	33.48
1276	120.3	132.7	33.69	33.47
1277	120.3	132.7	33.69	33.47
1278	120.4	132.7	33.70	33.46
1279	120.4	132.7	33.70	33.45
1280	120.4	132.7	33.70	33.44
1281	120.4	132.7	33.70	33.43
1282	120.5	132.7	33.70	33.43
1283	120.5	132.7	33.71	33.42
1284	120.5	132.7	33.71	33.41
1285	120.5	132.7	33.71	33.40
1286	120.6	132.7	33.71	33.39
1287	120.6	132.7	33.72	33.39
1288	120.6	132.8	33.72	33.38
1289	120.6	132.8	33.72	33.37

室内ユニット 合計容量	能力 (kW)		入力 (kW)	
	冷房	暖房	冷房	暖房
1290	120.7	132.8	33.72	33.36
1291	120.7	132.8	33.72	33.35
1292	120.7	132.8	33.73	33.35
1293	120.7	132.8	33.73	33.34
1294	120.8	132.8	33.73	33.33
1295	120.8	132.8	33.73	33.32
1296	120.8	132.8	33.74	33.31
1297	120.8	132.8	33.74	33.31
1298	120.9	132.8	33.74	33.30
1299	120.9	132.8	33.74	33.29
1300	120.9	132.8	33.74	33.28
1301	120.9	132.8	33.75	33.27
1302	120.9	132.8	33.75	33.27
1303	121.0	132.9	33.75	33.26
1304	121.0	132.9	33.75	33.25
1305	121.0	132.9	33.75	33.24
1306	121.0	132.9	33.76	33.24
1307	121.1	132.9	33.76	33.23
1308	121.1	132.9	33.76	33.22
1309	121.1	132.9	33.76	33.21
1310	121.1	132.9	33.77	33.20
1311	121.2	132.9	33.77	33.20
1312	121.2	132.9	33.77	33.19
1313	121.2	132.9	33.77	33.18
1314	121.2	132.9	33.77	33.17
1315	121.3	132.9	33.78	33.16
1316	121.3	132.9	33.78	33.16
1317	121.3	132.9	33.78	33.15
1318	121.3	133.0	33.78	33.14
1319	121.4	133.0	33.79	33.13
1320	121.4	133.0	33.79	33.12
1321	121.4	133.0	33.79	33.12
1322	121.4	133.0	33.79	33.11
1323	121.5	133.0	33.79	33.10
1324	121.5	133.0	33.80	33.09
1325	121.5	133.0	33.80	33.08
1326	121.5	133.0	33.80	33.08
1327	121.6	133.0	33.80	33.07
1328	121.6	133.0	33.81	33.06
1329	121.6	133.0	33.81	33.05
1330	121.6	133.0	33.81	33.04
1331	121.6	133.0	33.81	33.04
1332	121.7	133.0	33.81	33.03
1333	121.7	133.1	33.82	33.02
1334	121.7	133.1	33.82	33.01
1335	121.7	133.1	33.82	33.00
1336	121.8	133.1	33.82	33.00
1337	121.8	133.1	33.83	32.99
1338	121.8	133.1	33.83	32.98
1339	121.8	133.1	33.83	32.97
1340	121.9	133.1	33.83	32.96
1341	121.9	133.1	33.83	32.96
1342	121.9	133.1	33.84	32.95
1343	121.9	133.1	33.84	32.94
1344	122.0	133.1	33.84	32.93
1345	122.0	133.1	33.84	32.92
1346	122.0	133.1	33.85	32.92
1347	122.0	133.1	33.85	32.91
1348	122.1	133.2	33.85	32.90
1349	122.1	133.2	33.85	32.89
1350	122.1	133.2	33.85	32.88
1351	122.1	133.2	33.86	32.88
1352	122.2	133.2	33.86	32.87
1353	122.2	133.2	33.86	32.86
1354	122.2	133.2	33.86	32.85
1355	122.2	133.2	33.87	32.84
1356	122.3	133.2	33.87	32.84
1357	122.3	133.2	33.87	32.83
1358	122.3	133.2	33.87	32.82
1359	122.3	133.2	33.87	32.81

室内ユニット 合計容量	能力 (kW)		入力 (kW)	
	冷房	暖房	冷房	暖房
1360	122.3	133.2	33.88	32.80
1361	122.4	133.2	33.88	32.80
1362	122.4	133.2	33.88	32.79
1363	122.4	133.3	33.88	32.78
1364	122.4	133.3	33.88	32.77
1365	122.5	133.3	33.89	32.77
1366	122.5	133.3	33.89	32.76
1367	122.5	133.3	33.89	32.75
1368	122.5	133.3	33.89	32.74
1369	122.6	133.3	33.90	32.73
1370	122.6	133.3	33.90	32.73
1371	122.6	133.3	33.90	32.72
1372	122.6	133.3	33.90	32.71
1373	122.7	133.3	33.90	32.70
1374	122.7	133.3	33.91	32.69
1375	122.7	133.3	33.91	32.69
1376	122.7	133.3	33.91	32.68
1377	122.8	133.3	33.91	32.67
1378	122.8	133.4	33.92	32.66
1379	122.8	133.4	33.92	32.65
1380	122.8	133.4	33.92	32.65
1381	122.9	133.4	33.92	32.64
1382	122.9	133.4	33.92	32.63
1383	122.9	133.4	33.93	32.62
1384	122.9	133.4	33.93	32.61
1385	123.0	133.4	33.93	32.61
1386	123.0	133.4	33.93	32.60
1387	123.0	133.4	33.94	32.59
1388	123.0	133.4	33.94	32.58
1389	123.0	133.4	33.94	32.57
1390	123.1	133.4	33.94	32.57
1391	123.1	133.4	33.94	32.56
1392	123.1	133.4	33.95	32.55
1393	123.1	133.5	33.95	32.54
1394	123.2	133.5	33.95	32.53
1395	123.2	133.5	33.95	32.53
1396	123.2	133.5	33.96	32.52
1397	123.2	133.5	33.96	32.51
1398	123.3	133.5	33.96	32.50
1399	123.3	133.5	33.96	32.49
1400	123.3	133.5	33.96	32.49
1401	123.3	133.5	33.97	32.48
1402	123.4	133.5	33.97	32.47
1403	123.4	133.5	33.97	32.46
1404	123.4	133.5	33.97	32.45
1405	123.4	133.5	33.98	32.45
1406	123.5	133.5	33.98	32.44
1407	123.5	133.5	33.98	32.43
1408	123.5	133.6	33.98	32.42
1409	123.5	133.6	33.98	32.41
1410	123.6	133.6	33.99	32.41
1411	123.6	133.6	33.99	32.40
1412	123.6	133.6	33.99	32.39
1413	123.6	133.6	33.99	32.38
1414	123.6	133.6	34.00	32.37
1415	123.7	133.6	34.00	32.37
1416	123.7	133.6	34.00	32.36
1417	123.7	133.6	34.00	32.35
1418	123.7	133.6	34.00	32.34
1419	123.8	133.6	34.01	32.33
1420	123.8	133.6	34.01	32.33
1421	123.8	133.6	34.01	32.32
1422	123.8	133.7	34.01	32.31
1423	123.9	133.7	34.01	32.30
1424	123.9	133.7	34.02	32.29
1425	123.9	133.7	34.02	32.29
1426	123.9	133.7	34.02	32.28
1427	124.0	133.7	34.02	32.27
1428	124.0	133.7	34.03	32.26
1429	124.0	133.7	34.03	32.26

### 【PUHY-P1180SKM-E】

室内ユニット 合計容量	能力 (kW)		入力 (kW)	
	冷房	暖房	冷房	暖房
1430	124.0	133.7	34.03	32.25
1431	124.1	133.7	34.03	32.24
1432	124.1	133.7	34.03	32.23
1433	124.1	133.7	34.04	32.22
1434	124.1	133.7	34.04	32.22
1435	124.2	133.7	34.04	32.21
1436	124.2	133.7	34.04	32.20
1437	124.2	133.8	34.05	32.19
1438	124.2	133.8	34.05	32.18
1439	124.3	133.8	34.05	32.18
1440	124.3	133.8	34.05	32.17
1441	124.3	133.8	34.05	32.16
1442	124.3	133.8	34.06	32.15
1443	124.3	133.8	34.06	32.14
1444	124.4	133.8	34.06	32.14
1445	124.4	133.8	34.06	32.13
1446	124.4	133.8	34.07	32.12
1447	124.4	133.8	34.07	32.11
1448	124.5	133.8	34.07	32.10
1449	124.5	133.8	34.07	32.10
1450	124.5	133.8	34.07	32.09
1451	124.5	133.8	34.08	32.08
1452	124.6	133.9	34.08	32.07
1453	124.6	133.9	34.08	32.06
1454	124.6	133.9	34.08	32.06
1455	124.6	133.9	34.09	32.05
1456	124.7	133.9	34.09	32.04
1457	124.7	133.9	34.09	32.03
1458	124.7	133.9	34.09	32.02
1459	124.7	133.9	34.09	32.02
1460	124.8	133.9	34.10	32.01
1461	124.8	133.9	34.10	32.00
1462	124.8	133.9	34.10	31.99
1463	124.8	133.9	34.10	31.98
1464	124.9	133.9	34.11	31.98
1465	124.9	133.9	34.11	31.97
1466	124.9	133.9	34.11	31.96
1467	124.9	134.0	34.11	31.95
1468	125.0	134.0	34.11	31.94
1469	125.0	134.0	34.12	31.94
1470	125.0	134.0	34.12	31.93
1471	125.0	134.0	34.12	31.92
1472	125.0	134.0	34.12	31.91
1473	125.1	134.0	34.13	31.90
1474	125.1	134.0	34.13	31.90
1475	125.1	134.0	34.13	31.89
1476	125.1	134.0	34.13	31.88
1477	125.2	134.0	34.13	31.87
1478	125.2	134.0	34.14	31.86
1479	125.2	134.0	34.14	31.86
1480	125.2	134.0	34.14	31.85
1481	125.3	134.0	34.14	31.84
1482	125.3	134.1	34.14	31.83
1483	125.3	134.1	34.15	31.82
1484	125.3	134.1	34.15	31.82
1485	125.4	134.1	34.15	31.81
1486	125.4	134.1	34.15	31.80
1487	125.4	134.1	34.16	31.79
1488	125.4	134.1	34.16	31.79
1489	125.5	134.1	34.16	31.78
1490	125.5	134.1	34.16	31.77
1491	125.5	134.1	34.16	31.76
1492	125.5	134.1	34.17	31.75
1493	125.6	134.1	34.17	31.75
1494	125.6	134.1	34.17	31.74
1495	125.6	134.1	34.17	31.73
1496	125.6	134.1	34.18	31.72
1497	125.7	134.2	34.18	31.71
1498	125.7	134.2	34.18	31.71
1499	125.7	134.2	34.18	31.70

室内ユニット 合計容量	能力 (kW)		入力 (kW)	
	冷房	暖房	冷房	暖房
1500	125.7	134.2	34.18	31.69
1501	125.7	134.2	34.19	31.68
1502	125.8	134.2	34.19	31.67
1503	125.8	134.2	34.19	31.67
1504	125.8	134.2	34.19	31.66
1505	125.8	134.2	34.20	31.65
1506	125.9	134.2	34.20	31.64
1507	125.9	134.2	34.20	31.63
1508	125.9	134.2	34.20	31.63
1509	125.9	134.2	34.20	31.62
1510	126.0	134.2	34.21	31.61
1511	126.0	134.2	34.21	31.60
1512	126.0	134.3	34.21	31.59
1513	126.0	134.3	34.21	31.59
1514	126.1	134.3	34.22	31.58
1515	126.1	134.3	34.22	31.57
1516	126.1	134.3	34.22	31.56
1517	126.1	134.3	34.22	31.55
1518	126.2	134.3	34.22	31.55
1519	126.2	134.3	34.23	31.54
1520	126.2	134.3	34.23	31.53
1521	126.2	134.3	34.23	31.52
1522	126.3	134.3	34.23	31.51
1523	126.3	134.3	34.24	31.51
1524	126.3	134.3	34.24	31.50
1525	126.3	134.3	34.24	31.49
1526	126.4	134.3	34.24	31.48
1527	126.4	134.4	34.24	31.47
1528	126.4	134.4	34.25	31.47
1529	126.4	134.4	34.25	31.46
1530	126.4	134.4	34.25	31.45
1531	126.5	134.4	34.25	31.44
1532	126.5	134.4	34.25	31.43
1533	126.5	134.4	34.26	31.43
1534	126.5	134.4	34.26	31.42



【PUHY-P1240SKM-E】

室内ユニット 合計容量	能力 (kW)		入力 (kW)	
	冷房	暖房	冷房	暖房
620	62.0	70.0	18.09	19.64
621	62.1	70.1	18.12	19.67
622	62.2	70.2	18.15	19.70
623	62.3	70.3	18.18	19.73
624	62.4	70.4	18.21	19.76
625	62.5	70.6	18.24	19.80
626	62.6	70.7	18.27	19.83
627	62.7	70.8	18.31	19.86
628	62.8	70.9	18.34	19.89
629	62.9	71.0	18.37	19.92
630	63.0	71.1	18.40	19.95
631	63.1	71.2	18.43	19.98
632	63.2	71.4	18.46	20.01
633	63.3	71.5	18.49	20.04
634	63.4	71.6	18.52	20.07
635	63.5	71.7	18.55	20.10
636	63.6	71.8	18.58	20.13
637	63.7	71.9	18.61	20.16
638	63.8	72.0	18.64	20.19
639	63.9	72.1	18.67	20.22
640	64.0	72.3	18.70	20.25
641	64.1	72.4	18.73	20.29
642	64.2	72.5	18.76	20.32
643	64.3	72.6	18.79	20.35
644	64.4	72.7	18.82	20.38
645	64.5	72.8	18.85	20.41
646	64.6	72.9	18.88	20.44
647	64.7	73.0	18.91	20.47
648	64.8	73.2	18.94	20.50
649	64.9	73.3	18.97	20.53
650	65.0	73.4	19.00	20.56
651	65.1	73.5	19.03	20.59
652	65.2	73.6	19.06	20.62
653	65.3	73.7	19.09	20.65
654	65.4	73.8	19.12	20.68
655	65.5	73.9	19.15	20.71
656	65.6	74.1	19.18	20.74
657	65.7	74.2	19.21	20.77
658	65.8	74.3	19.24	20.80
659	65.9	74.4	19.28	20.83
660	66.0	74.5	19.31	20.86
661	66.1	74.6	19.34	20.89
662	66.2	74.7	19.37	20.92
663	66.3	74.9	19.40	20.96
664	66.4	75.0	19.43	20.99
665	66.5	75.1	19.46	21.02
666	66.6	75.2	19.49	21.05
667	66.7	75.3	19.52	21.08
668	66.8	75.4	19.55	21.11
669	66.9	75.5	19.58	21.14
670	67.0	75.6	19.61	21.17
671	67.1	75.8	19.64	21.20
672	67.2	75.9	19.67	21.23
673	67.3	76.0	19.70	21.26
674	67.4	76.1	19.73	21.29
675	67.5	76.2	19.76	21.32
676	67.6	76.3	19.79	21.35
677	67.7	76.4	19.82	21.38
678	67.8	76.5	19.85	21.41
679	67.9	76.7	19.88	21.44
680	68.0	76.8	19.91	21.47
681	68.1	76.9	19.94	21.50
682	68.2	77.0	19.97	21.53
683	68.3	77.1	20.00	21.56
684	68.4	77.2	20.03	21.59
685	68.5	77.3	20.06	21.62
686	68.6	77.4	20.09	21.65
687	68.7	77.6	20.12	21.68
688	68.8	77.7	20.15	21.71
689	68.9	77.8	20.18	21.74

室内ユニット 合計容量	能力 (kW)		入力 (kW)	
	冷房	暖房	冷房	暖房
690	69.0	77.9	20.21	21.77
691	69.1	78.0	20.24	21.80
692	69.2	78.1	20.27	21.83
693	69.3	78.2	20.30	21.86
694	69.4	78.4	20.33	21.89
695	69.5	78.5	20.36	21.92
696	69.6	78.6	20.39	21.95
697	69.7	78.7	20.42	21.98
698	69.8	78.8	20.45	22.01
699	69.9	78.9	20.48	22.04
700	70.0	79.0	20.51	22.07
701	70.1	79.1	20.54	22.10
702	70.2	79.3	20.57	22.13
703	70.3	79.4	20.60	22.16
704	70.4	79.5	20.63	22.19
705	70.5	79.6	20.66	22.22
706	70.6	79.7	20.69	22.25
707	70.7	79.8	20.72	22.28
708	70.8	79.9	20.75	22.31
709	70.9	80.0	20.79	22.34
710	71.0	80.2	20.82	22.37
711	71.1	80.3	20.85	22.40
712	71.2	80.4	20.88	22.43
713	71.3	80.5	20.91	22.46
714	71.4	80.6	20.94	22.49
715	71.5	80.7	20.97	22.52
716	71.6	80.8	21.00	22.55
717	71.7	80.9	21.03	22.58
718	71.8	81.1	21.06	22.61
719	71.9	81.2	21.09	22.64
720	72.0	81.3	21.12	22.67
721	72.1	81.4	21.15	22.70
722	72.2	81.5	21.18	22.73
723	72.3	81.6	21.21	22.76
724	72.4	81.7	21.24	22.79
725	72.5	81.9	21.27	22.82
726	72.6	82.0	21.30	22.85
727	72.7	82.1	21.33	22.88
728	72.8	82.2	21.36	22.91
729	72.9	82.3	21.39	22.94
730	73.0	82.4	21.42	22.97
731	73.1	82.5	21.45	23.00
732	73.2	82.6	21.48	23.03
733	73.3	82.8	21.51	23.06
734	73.4	82.9	21.54	23.09
735	73.5	83.0	21.57	23.12
736	73.6	83.1	21.60	23.15
737	73.7	83.2	21.63	23.18
738	73.8	83.3	21.66	23.20
739	73.9	83.4	21.69	23.23
740	74.0	83.5	21.72	23.26
741	74.1	83.7	21.75	23.29
742	74.2	83.8	21.78	23.32
743	74.3	83.9	21.81	23.35
744	74.4	84.0	21.84	23.38
745	74.5	84.1	21.87	23.41
746	74.6	84.2	21.90	23.44
747	74.7	84.3	21.93	23.47
748	74.8	84.4	21.96	23.50
749	74.9	84.6	21.99	23.53
750	75.0	84.7	22.02	23.56
751	75.1	84.8	22.05	23.59
752	75.2	84.9	22.08	23.62
753	75.3	85.0	22.11	23.65
754	75.4	85.1	22.14	23.68
755	75.5	85.2	22.17	23.71
756	75.6	85.4	22.20	23.74
757	75.7	85.5	22.23	23.77
758	75.8	85.6	22.26	23.80
759	75.9	85.7	22.29	23.83

室内ユニット 合計容量	能力 (kW)		入力 (kW)	
	冷房	暖房	冷房	暖房
760	76.0	85.8	22.32	23.85
761	76.1	85.9	22.35	23.88
762	76.2	86.0	22.38	23.91
763	76.3	86.1	22.41	23.94
764	76.4	86.3	22.44	23.97
765	76.5	86.4	22.47	24.00
766	76.6	86.5	22.50	24.03
767	76.7	86.6	22.53	24.06
768	76.8	86.7	22.56	24.09
769	76.9	86.8	22.59	24.12
770	77.0	86.9	22.62	24.15
771	77.1	87.0	22.65	24.18
772	77.2	87.2	22.68	24.21
773	77.3	87.3	22.71	24.24
774	77.4	87.4	22.74	24.27
775	77.5	87.5	22.77	24.30
776	77.6	87.6	22.80	24.32
777	77.7	87.7	22.83	24.35
778	77.8	87.8	22.86	24.38
779	77.9	87.9	22.89	24.41
780	78.0	88.1	22.92	24.44
781	78.1	88.2	22.95	24.47
782	78.2	88.3	22.98	24.50
783	78.3	88.4	23.01	24.53
784	78.4	88.5	23.04	24.56
785	78.5	88.6	23.07	24.59
786	78.6	88.7	23.10	24.62
787	78.7	88.9	23.13	24.65
788	78.8	89.0	23.16	24.68
789	78.9	89.1	23.19	24.71
790	79.0	89.2	23.22	24.73
791	79.1	89.3	23.25	24.76
792	79.2	89.4	23.28	24.79
793	79.3	89.5	23.31	24.82
794	79.4	89.6	23.34	24.85
795	79.5	89.8	23.37	24.88
796	79.6	89.9	23.40	24.91
797	79.7	90.0	23.43	24.94
798	79.8	90.1	23.46	24.97
799	79.9	90.2	23.49	25.00
800	80.0	90.3	23.52	25.03
801	80.1	90.4	23.55	25.05
802	80.2	90.5	23.57	25.08
803	80.3	90.7	23.60	25.11
804	80.4	90.8	23.63	25.14
805	80.5	90.9	23.66	25.17
806	80.6	91.0	23.69	25.20
807	80.7	91.1	23.72	25.23
808	80.8	91.2	23.75	25.26
809	80.9	91.3	23.78	25.29
810	81.0	91.4	23.81	25.32
811	81.1	91.6	23.84	25.34
812	81.2	91.7	23.87	25.37
813	81.3	91.8	23.90	25.40
814	81.4	91.9	23.93	25.43
815	81.5	92.0	23.96	25.46
816	81.6	92.1	23.99	25.49
817	81.7	92.2	24.02	25.52
818	81.8	92.4	24.05	25.55
819	81.9	92.5	24.08	25.58
820	82.0	92.6	24.11	25.61
821	82.1	92.7	24.14	25.63
822	82.2	92.8	24.17	25.66
823	82.3	92.9	24.20	25.69
824	82.4	93.0	24.23	25.72
825	82.5	93.1	24.26	25.75
826	82.6	93.3	24.29	25.78
827	82.7	93.4	24.32	25.81
828	82.8	93.5	24.35	25.84
829	82.9	93.6	24.38	25.86

【PUHY-P1240SKM-E】

室内ユニット 合計容量	能力 (kW)		入力 (kW)	
	冷房	暖房	冷房	暖房
830	83.0	93.7	24.41	25.89
831	83.1	93.8	24.44	25.92
832	83.2	93.9	24.47	25.95
833	83.3	94.0	24.50	25.98
834	83.4	94.2	24.53	26.01
835	83.5	94.3	24.56	26.04
836	83.6	94.4	24.59	26.07
837	83.7	94.5	24.62	26.10
838	83.8	94.6	24.65	26.12
839	83.9	94.7	24.68	26.15
840	84.0	94.8	24.71	26.18
841	84.1	94.9	24.74	26.21
842	84.2	95.1	24.77	26.24
843	84.3	95.2	24.80	26.27
844	84.4	95.3	24.83	26.30
845	84.5	95.4	24.86	26.32
846	84.6	95.5	24.89	26.35
847	84.7	95.6	24.92	26.38
848	84.8	95.7	24.95	26.41
849	84.9	95.9	24.98	26.44
850	85.0	96.0	25.01	26.47
851	85.1	96.1	25.04	26.50
852	85.2	96.2	25.07	26.53
853	85.3	96.3	25.09	26.55
854	85.4	96.4	25.12	26.58
855	85.5	96.5	25.15	26.61
856	85.6	96.6	25.18	26.64
857	85.7	96.8	25.21	26.67
858	85.8	96.9	25.24	26.70
859	85.9	97.0	25.27	26.73
860	86.0	97.1	25.30	26.75
861	86.1	97.2	25.33	26.78
862	86.2	97.3	25.36	26.81
863	86.3	97.4	25.39	26.84
864	86.4	97.5	25.42	26.87
865	86.5	97.7	25.45	26.90
866	86.6	97.8	25.48	26.92
867	86.7	97.9	25.51	26.95
868	86.8	98.0	25.54	26.98
869	86.9	98.1	25.57	27.01
870	87.0	98.2	25.60	27.04
871	87.1	98.3	25.63	27.07
872	87.2	98.4	25.66	27.10
873	87.3	98.6	25.69	27.12
874	87.4	98.7	25.72	27.15
875	87.5	98.8	25.75	27.18
876	87.6	98.9	25.78	27.21
877	87.7	99.0	25.81	27.24
878	87.8	99.1	25.84	27.27
879	87.9	99.2	25.87	27.29
880	88.0	99.4	25.90	27.32
881	88.1	99.5	25.93	27.35
882	88.2	99.6	25.96	27.38
883	88.3	99.7	25.99	27.41
884	88.4	99.8	26.02	27.44
885	88.5	99.9	26.04	27.46
886	88.6	100.0	26.07	27.49
887	88.7	100.1	26.10	27.52
888	88.8	100.3	26.13	27.55
889	88.9	100.4	26.16	27.58
890	89.0	100.5	26.19	27.61
891	89.1	100.6	26.22	27.63
892	89.2	100.7	26.25	27.66
893	89.3	100.8	26.28	27.69
894	89.4	100.9	26.31	27.72
895	89.5	101.0	26.34	27.75
896	89.6	101.2	26.37	27.77
897	89.7	101.3	26.40	27.80
898	89.8	101.4	26.43	27.83
899	89.9	101.5	26.46	27.86

室内ユニット 合計容量	能力 (kW)		入力 (kW)	
	冷房	暖房	冷房	暖房
900	90.0	101.6	26.49	27.89
901	90.1	101.7	26.52	27.92
902	90.2	101.8	26.55	27.94
903	90.3	101.9	26.58	27.97
904	90.4	102.1	26.61	28.00
905	90.5	102.2	26.64	28.03
906	90.6	102.3	26.67	28.06
907	90.7	102.4	26.70	28.08
908	90.8	102.5	26.73	28.11
909	90.9	102.6	26.76	28.14
910	91.0	102.7	26.78	28.17
911	91.1	102.9	26.81	28.20
912	91.2	103.0	26.84	28.22
913	91.3	103.1	26.87	28.25
914	91.4	103.2	26.90	28.28
915	91.5	103.3	26.93	28.31
916	91.6	103.4	26.96	28.34
917	91.7	103.5	26.99	28.37
918	91.8	103.6	27.02	28.39
919	91.9	103.8	27.05	28.42
920	92.0	103.9	27.08	28.45
921	92.1	104.0	27.11	28.48
922	92.2	104.1	27.14	28.51
923	92.3	104.2	27.17	28.53
924	92.4	104.3	27.20	28.56
925	92.5	104.4	27.23	28.59
926	92.6	104.5	27.26	28.62
927	92.7	104.7	27.29	28.64
928	92.8	104.8	27.32	28.67
929	92.9	104.9	27.35	28.70
930	93.0	105.0	27.38	28.73
931	93.1	105.1	27.41	28.76
932	93.2	105.2	27.43	28.78
933	93.3	105.3	27.46	28.81
934	93.4	105.4	27.49	28.84
935	93.5	105.6	27.52	28.87
936	93.6	105.7	27.55	28.90
937	93.7	105.8	27.58	28.92
938	93.8	105.9	27.61	28.95
939	93.9	106.0	27.64	28.98
940	94.0	106.1	27.67	29.01
941	94.1	106.2	27.70	29.03
942	94.2	106.4	27.73	29.06
943	94.3	106.5	27.76	29.09
944	94.4	106.6	27.79	29.12
945	94.5	106.7	27.82	29.15
946	94.6	106.8	27.85	29.17
947	94.7	106.9	27.88	29.20
948	94.8	107.0	27.91	29.23
949	94.9	107.1	27.94	29.26
950	95.0	107.3	27.97	29.28
951	95.1	107.4	27.99	29.31
952	95.2	107.5	28.02	29.34
953	95.3	107.6	28.05	29.37
954	95.4	107.7	28.08	29.40
955	95.5	107.8	28.11	29.42
956	95.6	107.9	28.14	29.45
957	95.7	108.0	28.17	29.48
958	95.8	108.2	28.20	29.51
959	95.9	108.3	28.23	29.53
960	96.0	108.4	28.26	29.56
961	96.1	108.5	28.29	29.59
962	96.2	108.6	28.32	29.62
963	96.3	108.7	28.35	29.64
964	96.4	108.8	28.38	29.67
965	96.5	108.9	28.41	29.70
966	96.6	109.1	28.44	29.73
967	96.7	109.2	28.47	29.75
968	96.8	109.3	28.50	29.78
969	96.9	109.4	28.52	29.81

室内ユニット 合計容量	能力 (kW)		入力 (kW)	
	冷房	暖房	冷房	暖房
970	97.0	109.5	28.55	29.84
971	97.1	109.6	28.58	29.86
972	97.2	109.7	28.61	29.89
973	97.3	109.9	28.64	29.92
974	97.4	110.0	28.67	29.95
975	97.5	110.1	28.70	29.97
976	97.6	110.2	28.73	30.00
977	97.7	110.3	28.76	30.03
978	97.8	110.4	28.79	30.06
979	97.9	110.5	28.82	30.08
980	98.0	110.6	28.85	30.11
981	98.1	110.8	28.88	30.14
982	98.2	110.9	28.91	30.17
983	98.3	111.0	28.94	30.19
984	98.4	111.1	28.97	30.22
985	98.5	111.2	28.99	30.25
986	98.6	111.3	29.02	30.28
987	98.7	111.4	29.05	30.30
988	98.8	111.5	29.08	30.33
989	98.9	111.7	29.11	30.36
990	99.0	111.8	29.14	30.39
991	99.1	111.9	29.17	30.41
992	99.2	112.0	29.20	30.44
993	99.3	112.1	29.23	30.47
994	99.4	112.2	29.26	30.49
995	99.5	112.3	29.29	30.52
996	99.6	112.4	29.32	30.55
997	99.7	112.6	29.35	30.58
998	99.8	112.7	29.38	30.60
999	99.9	112.8	29.41	30.63
1000	100.0	112.9	29.44	30.66
1001	100.1	113.0	29.46	30.69
1002	100.2	113.1	29.49	30.71
1003	100.3	113.2	29.52	30.74
1004	100.4	113.4	29.55	30.77
1005	100.5	113.5	29.58	30.79
1006	100.6	113.6	29.61	30.82
1007	100.7	113.7	29.64	30.85
1008	100.8	113.8	29.67	30.88
1009	100.9	113.9	29.70	30.90
1010	101.0	114.0	29.73	30.93
1011	101.1	114.1	29.76	30.96
1012	101.2	114.3	29.79	30.98
1013	101.3	114.4	29.82	31.01
1014	101.4	114.5	29.85	31.04
1015	101.5	114.6	29.87	31.07
1016	101.6	114.7	29.90	31.09
1017	101.7	114.8	29.93	31.12
1018	101.8	114.9	29.96	31.15
1019	101.9	115.0	29.99	31.17
1020	102.0	115.2	30.02	31.20
1021	102.1	115.3	30.05	31.23
1022	102.2	115.4	30.08	31.26
1023	102.3	115.5	30.11	31.28
1024	102.4	115.6	30.14	31.31
1025	102.5	115.7	30.17	31.34
1026	102.6	115.8	30.20	31.36
1027	102.7	115.9	30.23	31.39
1028	102.8	116.1	30.25	31.42
1029	102.9	116.2	30.28	31.44
1030	103.0	116.3	30.31	31.47
1031	103.1	116.4	30.34	31.50
1032	103.2	116.5	30.37	31.53
1033	103.3	116.6	30.40	31.55
1034	103.4	116.7	30.43	31.58
1035	103.5	116.9	30.46	31.61
1036	103.6	117.0	30.49	31.63
1037	103.7	117.1	30.52	31.66
1038	103.8	117.2	30.55	31.69
1039	103.9	117.3	30.58	31.71

【PUHY-P1240SKM-E】

室内ユニット 合計容量	能力 (kW)		入力 (kW)	
	冷房	暖房	冷房	暖房
1040	104.0	117.4	30.61	31.74
1041	104.1	117.5	30.63	31.77
1042	104.2	117.6	30.66	31.79
1043	104.3	117.8	30.69	31.82
1044	104.4	117.9	30.72	31.85
1045	104.5	118.0	30.75	31.87
1046	104.6	118.1	30.78	31.90
1047	104.7	118.2	30.81	31.93
1048	104.8	118.3	30.84	31.96
1049	104.9	118.4	30.87	31.98
1050	105.0	118.5	30.90	32.01
1051	105.1	118.7	30.93	32.04
1052	105.2	118.8	30.96	32.06
1053	105.3	118.9	30.99	32.09
1054	105.4	119.0	31.01	32.12
1055	105.5	119.1	31.04	32.14
1056	105.6	119.2	31.07	32.17
1057	105.7	119.3	31.10	32.20
1058	105.8	119.4	31.13	32.22
1059	105.9	119.6	31.16	32.25
1060	106.0	119.7	31.19	32.28
1061	106.1	119.8	31.22	32.30
1062	106.2	119.9	31.25	32.33
1063	106.3	120.0	31.28	32.36
1064	106.4	120.1	31.31	32.38
1065	106.5	120.2	31.34	32.41
1066	106.6	120.4	31.36	32.44
1067	106.7	120.5	31.39	32.46
1068	106.8	120.6	31.42	32.49
1069	106.9	120.7	31.45	32.52
1070	107.0	120.8	31.48	32.54
1071	107.1	120.9	31.51	32.57
1072	107.2	121.0	31.54	32.60
1073	107.3	121.1	31.57	32.62
1074	107.4	121.3	31.60	32.65
1075	107.5	121.4	31.63	32.68
1076	107.6	121.5	31.66	32.70
1077	107.7	121.6	31.68	32.73
1078	107.8	121.7	31.71	32.76
1079	107.9	121.8	31.74	32.78
1080	108.0	121.9	31.77	32.81
1081	108.1	122.0	31.80	32.83
1082	108.2	122.2	31.83	32.86
1083	108.3	122.3	31.86	32.89
1084	108.4	122.4	31.89	32.91
1085	108.5	122.5	31.92	32.94
1086	108.6	122.6	31.95	32.97
1087	108.7	122.7	31.98	32.99
1088	108.8	122.8	32.00	33.02
1089	108.9	122.9	32.03	33.05
1090	109.0	123.1	32.06	33.07
1091	109.1	123.2	32.09	33.10
1092	109.2	123.3	32.12	33.13
1093	109.3	123.4	32.15	33.15
1094	109.4	123.5	32.18	33.18
1095	109.5	123.6	32.21	33.20
1096	109.6	123.7	32.24	33.23
1097	109.7	123.9	32.27	33.26
1098	109.8	124.0	32.30	33.28
1099	109.9	124.1	32.32	33.31
1100	110.0	124.2	32.35	33.34
1101	110.1	124.3	32.38	33.36
1102	110.2	124.4	32.41	33.39
1103	110.3	124.5	32.44	33.42
1104	110.4	124.6	32.47	33.44
1105	110.5	124.8	32.50	33.47
1106	110.6	124.9	32.53	33.49
1107	110.7	125.0	32.56	33.52
1108	110.8	125.1	32.59	33.55
1109	110.9	125.2	32.61	33.57

室内ユニット 合計容量	能力 (kW)		入力 (kW)	
	冷房	暖房	冷房	暖房
1110	111.0	125.3	32.64	33.60
1111	111.1	125.4	32.67	33.63
1112	111.2	125.5	32.70	33.65
1113	111.3	125.7	32.73	33.68
1114	111.4	125.8	32.76	33.70
1115	111.5	125.9	32.79	33.73
1116	111.6	126.0	32.82	33.76
1117	111.7	126.1	32.85	33.78
1118	111.8	126.2	32.88	33.81
1119	111.9	126.3	32.90	33.83
1120	112.0	126.4	32.93	33.86
1121	112.1	126.6	32.96	33.89
1122	112.2	126.7	32.99	33.91
1123	112.3	126.8	33.02	33.94
1124	112.4	126.9	33.05	33.97
1125	112.5	127.0	33.08	33.99
1126	112.6	127.1	33.11	34.02
1127	112.7	127.2	33.14	34.04
1128	112.8	127.4	33.17	34.07
1129	112.9	127.5	33.19	34.10
1130	113.0	127.6	33.22	34.12
1131	113.1	127.7	33.25	34.15
1132	113.2	127.8	33.28	34.17
1133	113.3	127.9	33.31	34.20
1134	113.4	128.0	33.34	34.23
1135	113.5	128.1	33.37	34.25
1136	113.6	128.3	33.40	34.28
1137	113.7	128.4	33.43	34.30
1138	113.8	128.5	33.46	34.33
1139	113.9	128.6	33.48	34.36
1140	114.0	128.7	33.51	34.38
1141	114.1	128.8	33.54	34.41
1142	114.2	128.9	33.57	34.43
1143	114.3	129.0	33.60	34.46
1144	114.4	129.2	33.63	34.49
1145	114.5	129.3	33.66	34.51
1146	114.6	129.4	33.69	34.54
1147	114.7	129.5	33.72	34.56
1148	114.8	129.6	33.74	34.59
1149	114.9	129.7	33.77	34.62
1150	115.0	129.8	33.80	34.64
1151	115.1	129.9	33.83	34.67
1152	115.2	130.1	33.86	34.69
1153	115.3	130.2	33.89	34.72
1154	115.4	130.3	33.92	34.74
1155	115.5	130.4	33.95	34.77
1156	115.6	130.5	33.98	34.80
1157	115.7	130.6	34.00	34.82
1158	115.8	130.7	34.03	34.85
1159	115.9	130.9	34.06	34.87
1160	116.0	131.0	34.09	34.90
1161	116.1	131.1	34.12	34.93
1162	116.2	131.2	34.15	34.95
1163	116.3	131.3	34.18	34.98
1164	116.4	131.4	34.21	35.00
1165	116.5	131.5	34.24	35.03
1166	116.6	131.6	34.26	35.05
1167	116.7	131.8	34.29	35.08
1168	116.8	131.9	34.32	35.11
1169	116.9	132.0	34.35	35.13
1170	117.0	132.1	34.38	35.16
1171	117.1	132.2	34.41	35.18
1172	117.2	132.3	34.44	35.21
1173	117.3	132.4	34.47	35.23
1174	117.4	132.5	34.50	35.26
1175	117.5	132.7	34.52	35.29
1176	117.6	132.8	34.55	35.31
1177	117.7	132.9	34.58	35.34
1178	117.8	133.0	34.61	35.36
1179	117.9	133.1	34.64	35.39

室内ユニット 合計容量	能力 (kW)		入力 (kW)	
	冷房	暖房	冷房	暖房
1180	118.0	133.2	34.67	35.41
1181	118.1	133.3	34.70	35.44
1182	118.2	133.4	34.73	35.46
1183	118.3	133.6	34.75	35.49
1184	118.4	133.7	34.78	35.52
1185	118.5	133.8	34.81	35.54
1186	118.6	133.9	34.84	35.57
1187	118.7	134.0	34.87	35.59
1188	118.8	134.1	34.90	35.62
1189	118.9	134.2	34.93	35.64
1190	119.0	134.4	34.96	35.67
1191	119.1	134.5	34.99	35.69
1192	119.2	134.6	35.01	35.72
1193	119.3	134.7	35.04	35.75
1194	119.4	134.8	35.07	35.77
1195	119.5	134.9	35.10	35.80
1196	119.6	135.0	35.13	35.82
1197	119.7	135.1	35.16	35.85
1198	119.8	135.3	35.19	35.87
1199	119.9	135.4	35.22	35.90
1200	120.0	135.5	35.24	35.92
1201	120.1	135.6	35.27	35.95
1202	120.2	135.7	35.30	35.97
1203	120.3	135.8	35.33	36.00
1204	120.4	135.9	35.36	36.02
1205	120.5	136.0	35.39	36.05
1206	120.6	136.2	35.42	36.08
1207	120.7	136.3	35.45	36.10
1208	120.8	136.4	35.47	36.13
1209	120.9	136.5	35.50	36.15
1210	121.0	136.6	35.53	36.18
1211	121.1	136.7	35.56	36.20
1212	121.2	136.8	35.59	36.23
1213	121.3	136.9	35.62	36.25
1214	121.4	137.1	35.65	36.28
1215	121.5	137.2	35.68	36.30
1216	121.6	137.3	35.70	36.33
1217	121.7	137.4	35.73	36.35
1218	121.8	137.5	35.76	36.38
1219	121.9	137.6	35.79	36.40
1220	122.0	137.7	35.82	36.43
1221	122.1	137.9	35.85	36.45
1222	122.2	138.0	35.88	36.48
1223	122.3	138.1	35.90	36.51
1224	122.4	138.2	35.93	36.53
1225	122.5	138.3	35.96	36.56
1226	122.6	138.4	35.99	36.58
1227	122.7	138.5	36.02	36.61
1228	122.8	138.6	36.05	36.63
1229	122.9	138.8	36.08	36.66
1230	123.0	138.9	36.11	36.68
1231	123.1	139.0	36.13	36.71
1232	123.2	139.1	36.16	36.73
1233	123.3	139.2	36.19	36.76
1234	123.4	139.3	36.22	36.78
1235	123.5	139.4	36.25	36.81
1236	123.6	139.5	36.28	36.83
1237	123.7	139.7	36.31	36.86
1238	123.8	139.8	36.34	36.88
1239	123.9	139.9	36.36	36.91
1240	124.0	140.0	36.39	36.93
1241	124.0	140.0	36.39	36.92
1242	124.0	140.1	36.40	36.91
1243	124.1	140.1	36.40	36.90
1244	124.1	140.1	36.40	36.89
1245	124.1	140.1	36.41	36.88
1246	124.1	140.1	36.41	36.88
1247	124.2	140.1	36.41	36.87
1248	124.2	140.1	36.42	36.86
1249	124.2	140.1	36.42	36.85

# 【PUHY-P1240SKM-E】

室内ユニット 合計容量	能力 (kW)		入力 (kW)	
	冷房	暖房	冷房	暖房
1250	124.2	140.1	36.42	36.84
1251	124.3	140.1	36.43	36.83
1252	124.3	140.1	36.43	36.82
1253	124.3	140.1	36.43	36.81
1254	124.3	140.1	36.44	36.80
1255	124.4	140.1	36.44	36.79
1256	124.4	140.1	36.44	36.78
1257	124.4	140.1	36.45	36.77
1258	124.4	140.1	36.45	36.77
1259	124.5	140.1	36.45	36.76
1260	124.5	140.1	36.46	36.75
1261	124.5	140.1	36.46	36.74
1262	124.5	140.1	36.46	36.73
1263	124.5	140.1	36.47	36.72
1264	124.6	140.1	36.47	36.71
1265	124.6	140.1	36.47	36.70
1266	124.6	140.1	36.48	36.69
1267	124.6	140.1	36.48	36.68
1268	124.7	140.1	36.48	36.67
1269	124.7	140.1	36.49	36.67
1270	124.7	140.1	36.49	36.66
1271	124.7	140.1	36.49	36.65
1272	124.8	140.1	36.50	36.64
1273	124.8	140.1	36.50	36.63
1274	124.8	140.1	36.50	36.62
1275	124.8	140.1	36.51	36.61
1276	124.9	140.1	36.51	36.60
1277	124.9	140.1	36.51	36.59
1278	124.9	140.1	36.52	36.58
1279	124.9	140.1	36.52	36.57
1280	125.0	140.1	36.53	36.57
1281	125.0	140.1	36.53	36.56
1282	125.0	140.1	36.53	36.55
1283	125.0	140.2	36.54	36.54
1284	125.1	140.2	36.54	36.53
1285	125.1	140.2	36.54	36.52
1286	125.1	140.2	36.55	36.51
1287	125.1	140.2	36.55	36.50
1288	125.2	140.2	36.55	36.49
1289	125.2	140.2	36.56	36.48
1290	125.2	140.2	36.56	36.47
1291	125.2	140.2	36.56	36.47
1292	125.2	140.2	36.57	36.46
1293	125.3	140.2	36.57	36.45
1294	125.3	140.2	36.57	36.44
1295	125.3	140.2	36.58	36.43
1296	125.3	140.2	36.58	36.42
1297	125.4	140.2	36.58	36.41
1298	125.4	140.2	36.59	36.40
1299	125.4	140.2	36.59	36.39
1300	125.4	140.2	36.59	36.38
1301	125.5	140.2	36.60	36.37
1302	125.5	140.2	36.60	36.36
1303	125.5	140.2	36.60	36.36
1304	125.5	140.2	36.61	36.35
1305	125.6	140.2	36.61	36.34
1306	125.6	140.2	36.61	36.33
1307	125.6	140.2	36.62	36.32
1308	125.6	140.2	36.62	36.31
1309	125.7	140.2	36.62	36.30
1310	125.7	140.2	36.63	36.29
1311	125.7	140.2	36.63	36.28
1312	125.7	140.2	36.63	36.27
1313	125.8	140.2	36.64	36.26
1314	125.8	140.2	36.64	36.26
1315	125.8	140.2	36.64	36.25
1316	125.8	140.2	36.65	36.24
1317	125.8	140.2	36.65	36.23
1318	125.9	140.2	36.65	36.22
1319	125.9	140.2	36.66	36.21

室内ユニット 合計容量	能力 (kW)		入力 (kW)	
	冷房	暖房	冷房	暖房
1320	125.9	140.2	36.66	36.20
1321	125.9	140.2	36.67	36.19
1322	126.0	140.2	36.67	36.18
1323	126.0	140.3	36.67	36.17
1324	126.0	140.3	36.68	36.16
1325	126.0	140.3	36.68	36.16
1326	126.1	140.3	36.68	36.15
1327	126.1	140.3	36.69	36.14
1328	126.1	140.3	36.69	36.13
1329	126.1	140.3	36.69	36.12
1330	126.2	140.3	36.70	36.11
1331	126.2	140.3	36.70	36.10
1332	126.2	140.3	36.70	36.09
1333	126.2	140.3	36.71	36.08
1334	126.3	140.3	36.71	36.07
1335	126.3	140.3	36.71	36.06
1336	126.3	140.3	36.72	36.06
1337	126.3	140.3	36.72	36.05
1338	126.4	140.3	36.72	36.04
1339	126.4	140.3	36.73	36.03
1340	126.4	140.3	36.73	36.02
1341	126.4	140.3	36.73	36.01
1342	126.5	140.3	36.74	36.00
1343	126.5	140.3	36.74	35.99
1344	126.5	140.3	36.74	35.98
1345	126.5	140.3	36.75	35.97
1346	126.5	140.3	36.75	35.96
1347	126.6	140.3	36.75	35.95
1348	126.6	140.3	36.76	35.95
1349	126.6	140.3	36.76	35.94
1350	126.6	140.3	36.76	35.93
1351	126.7	140.3	36.77	35.92
1352	126.7	140.3	36.77	35.91
1353	126.7	140.3	36.77	35.90
1354	126.7	140.3	36.78	35.89
1355	126.8	140.3	36.78	35.88
1356	126.8	140.3	36.78	35.87
1357	126.8	140.3	36.79	35.86
1358	126.8	140.3	36.79	35.85
1359	126.9	140.3	36.80	35.85
1360	126.9	140.3	36.80	35.84
1361	126.9	140.3	36.80	35.83
1362	126.9	140.3	36.81	35.82
1363	127.0	140.3	36.81	35.81
1364	127.0	140.4	36.81	35.80
1365	127.0	140.4	36.82	35.79
1366	127.0	140.4	36.82	35.78
1367	127.1	140.4	36.82	35.77
1368	127.1	140.4	36.83	35.76
1369	127.1	140.4	36.83	35.75
1370	127.1	140.4	36.83	35.75
1371	127.2	140.4	36.84	35.74
1372	127.2	140.4	36.84	35.73
1373	127.2	140.4	36.84	35.72
1374	127.2	140.4	36.85	35.71
1375	127.2	140.4	36.85	35.70
1376	127.3	140.4	36.85	35.69
1377	127.3	140.4	36.86	35.68
1378	127.3	140.4	36.86	35.67
1379	127.3	140.4	36.86	35.66
1380	127.4	140.4	36.87	35.65
1381	127.4	140.4	36.87	35.64
1382	127.4	140.4	36.87	35.64
1383	127.4	140.4	36.88	35.63
1384	127.5	140.4	36.88	35.62
1385	127.5	140.4	36.88	35.61
1386	127.5	140.4	36.89	35.60
1387	127.5	140.4	36.89	35.59
1388	127.6	140.4	36.89	35.58
1389	127.6	140.4	36.90	35.57

室内ユニット 合計容量	能力 (kW)		入力 (kW)	
	冷房	暖房	冷房	暖房
1390	127.6	140.4	36.90	35.56
1391	127.6	140.4	36.90	35.55
1392	127.7	140.4	36.91	35.54
1393	127.7	140.4	36.91	35.54
1394	127.7	140.4	36.91	35.53
1395	127.7	140.4	36.92	35.52
1396	127.8	140.4	36.92	35.51
1397	127.8	140.4	36.92	35.50
1398	127.8	140.4	36.93	35.49
1399	127.8	140.4	36.93	35.48
1400	127.9	140.4	36.94	35.47
1401	127.9	140.4	36.94	35.46
1402	127.9	140.4	36.94	35.45
1403	127.9	140.4	36.95	35.44
1404	127.9	140.4	36.95	35.44
1405	128.0	140.5	36.95	35.43
1406	128.0	140.5	36.96	35.42
1407	128.0	140.5	36.96	35.41
1408	128.0	140.5	36.96	35.40
1409	128.1	140.5	36.97	35.39
1410	128.1	140.5	36.97	35.38
1411	128.1	140.5	36.97	35.37
1412	128.1	140.5	36.98	35.36
1413	128.2	140.5	36.98	35.35
1414	128.2	140.5	36.98	35.34
1415	128.2	140.5	36.99	35.34
1416	128.2	140.5	36.99	35.33
1417	128.3	140.5	36.99	35.32
1418	128.3	140.5	37.00	35.31
1419	128.3	140.5	37.00	35.30
1420	128.3	140.5	37.00	35.29
1421	128.4	140.5	37.01	35.28
1422	128.4	140.5	37.01	35.27
1423	128.4	140.5	37.01	35.26
1424	128.4	140.5	37.02	35.25
1425	128.5	140.5	37.02	35.24
1426	128.5	140.5	37.02	35.23
1427	128.5	140.5	37.03	35.23
1428	128.5	140.5	37.03	35.22
1429	128.5	140.5	37.03	35.21
1430	128.6	140.5	37.04	35.20
1431	128.6	140.5	37.04	35.19
1432	128.6	140.5	37.04	35.18
1433	128.6	140.5	37.05	35.17
1434	128.7	140.5	37.05	35.16
1435	128.7	140.5	37.05	35.15
1436	128.7	140.5	37.06	35.14
1437	128.7	140.5	37.06	35.13
1438	128.8	140.5	37.07	35.13
1439	128.8	140.5	37.07	35.12
1440	128.8	140.5	37.07	35.11
1441	128.8	140.5	37.08	35.10
1442	128.9	140.5	37.08	35.09
1443	128.9	140.5	37.08	35.08
1444	128.9	140.5	37.09	35.07
1445	128.9	140.6	37.09	35.06
1446	129.0	140.6	37.09	35.05
1447	129.0	140.6	37.10	35.04
1448	129.0	140.6	37.10	35.03
1449	129.0	140.6	37.10	35.03
1450	129.1	140.6	37.11	35.02
1451	129.1	140.6	37.11	35.01
1452	129.1	140.6	37.11	35.00
1453	129.1	140.6	37.12	34.99
1454	129.2	140.6	37.12	34.98
1455	129.2	140.6	37.12	34.97
1456	129.2	140.6	37.13	34.96
1457	129.2	140.6	37.13	34.95
1458	129.2	140.6	37.13	34.94
1459	129.3	140.6	37.14	34.93

## 【PUHY-P1240SKM-E】

室内ユニット 合計容量	能力 (kW)		入力 (kW)	
	冷房	暖房	冷房	暖房
1460	129.3	140.6	37.14	34.93
1461	129.3	140.6	37.14	34.92
1462	129.3	140.6	37.15	34.91
1463	129.4	140.6	37.15	34.90
1464	129.4	140.6	37.15	34.89
1465	129.4	140.6	37.16	34.88
1466	129.4	140.6	37.16	34.87
1467	129.5	140.6	37.16	34.86
1468	129.5	140.6	37.17	34.85
1469	129.5	140.6	37.17	34.84
1470	129.5	140.6	37.17	34.83
1471	129.6	140.6	37.18	34.82
1472	129.6	140.6	37.18	34.82
1473	129.6	140.6	37.18	34.81
1474	129.6	140.6	37.19	34.80
1475	129.7	140.6	37.19	34.79
1476	129.7	140.6	37.19	34.78
1477	129.7	140.6	37.20	34.77
1478	129.7	140.6	37.20	34.76
1479	129.8	140.6	37.21	34.75
1480	129.8	140.6	37.21	34.74
1481	129.8	140.6	37.21	34.73
1482	129.8	140.6	37.22	34.72
1483	129.9	140.6	37.22	34.72
1484	129.9	140.6	37.22	34.71
1485	129.9	140.6	37.23	34.70
1486	129.9	140.7	37.23	34.69
1487	129.9	140.7	37.23	34.68
1488	130.0	140.7	37.24	34.67
1489	130.0	140.7	37.24	34.66
1490	130.0	140.7	37.24	34.65
1491	130.0	140.7	37.25	34.64
1492	130.1	140.7	37.25	34.63
1493	130.1	140.7	37.25	34.62
1494	130.1	140.7	37.26	34.62
1495	130.1	140.7	37.26	34.61
1496	130.2	140.7	37.26	34.60
1497	130.2	140.7	37.27	34.59
1498	130.2	140.7	37.27	34.58
1499	130.2	140.7	37.27	34.57
1500	130.3	140.7	37.28	34.56
1501	130.3	140.7	37.28	34.55
1502	130.3	140.7	37.28	34.54
1503	130.3	140.7	37.29	34.53
1504	130.4	140.7	37.29	34.52
1505	130.4	140.7	37.29	34.51
1506	130.4	140.7	37.30	34.51
1507	130.4	140.7	37.30	34.50
1508	130.5	140.7	37.30	34.49
1509	130.5	140.7	37.31	34.48
1510	130.5	140.7	37.31	34.47
1511	130.5	140.7	37.31	34.46
1512	130.5	140.7	37.32	34.45
1513	130.6	140.7	37.32	34.44
1514	130.6	140.7	37.32	34.43
1515	130.6	140.7	37.33	34.42
1516	130.6	140.7	37.33	34.41
1517	130.7	140.7	37.34	34.41
1518	130.7	140.7	37.34	34.40
1519	130.7	140.7	37.34	34.39
1520	130.7	140.7	37.35	34.38
1521	130.8	140.7	37.35	34.37
1522	130.8	140.7	37.35	34.36
1523	130.8	140.7	37.36	34.35
1524	130.8	140.7	37.36	34.34
1525	130.9	140.7	37.36	34.33
1526	130.9	140.7	37.37	34.32
1527	130.9	140.8	37.37	34.31
1528	130.9	140.8	37.37	34.31
1529	131.0	140.8	37.38	34.30

室内ユニット 合計容量	能力 (kW)		入力 (kW)	
	冷房	暖房	冷房	暖房
1530	131.0	140.8	37.38	34.29
1531	131.0	140.8	37.38	34.28
1532	131.0	140.8	37.39	34.27
1533	131.1	140.8	37.39	34.26
1534	131.1	140.8	37.39	34.25
1535	131.1	140.8	37.40	34.24
1536	131.1	140.8	37.40	34.23
1537	131.2	140.8	37.40	34.22
1538	131.2	140.8	37.41	34.21
1539	131.2	140.8	37.41	34.21
1540	131.2	140.8	37.41	34.20
1541	131.2	140.8	37.42	34.19
1542	131.3	140.8	37.42	34.18
1543	131.3	140.8	37.42	34.17
1544	131.3	140.8	37.43	34.16
1545	131.3	140.8	37.43	34.15
1546	131.4	140.8	37.43	34.14
1547	131.4	140.8	37.44	34.13
1548	131.4	140.8	37.44	34.12
1549	131.4	140.8	37.44	34.11
1550	131.5	140.8	37.45	34.10
1551	131.5	140.8	37.45	34.10
1552	131.5	140.8	37.45	34.09
1553	131.5	140.8	37.46	34.08
1554	131.6	140.8	37.46	34.07
1555	131.6	140.8	37.46	34.06
1556	131.6	140.8	37.47	34.05
1557	131.6	140.8	37.47	34.04
1558	131.7	140.8	37.48	34.03
1559	131.7	140.8	37.48	34.02
1560	131.7	140.8	37.48	34.01
1561	131.7	140.8	37.49	34.00
1562	131.8	140.8	37.49	34.00
1563	131.8	140.8	37.49	33.99
1564	131.8	140.8	37.50	33.98
1565	131.8	140.8	37.50	33.97
1566	131.9	140.8	37.50	33.96
1567	131.9	140.9	37.51	33.95
1568	131.9	140.9	37.51	33.94
1569	131.9	140.9	37.51	33.93
1570	131.9	140.9	37.52	33.92
1571	132.0	140.9	37.52	33.91
1572	132.0	140.9	37.52	33.90
1573	132.0	140.9	37.53	33.90
1574	132.0	140.9	37.53	33.89
1575	132.1	140.9	37.53	33.88
1576	132.1	140.9	37.54	33.87
1577	132.1	140.9	37.54	33.86
1578	132.1	140.9	37.54	33.85
1579	132.2	140.9	37.55	33.84
1580	132.2	140.9	37.55	33.83
1581	132.2	140.9	37.55	33.82
1582	132.2	140.9	37.56	33.81
1583	132.3	140.9	37.56	33.80
1584	132.3	140.9	37.56	33.80
1585	132.3	140.9	37.57	33.79
1586	132.3	140.9	37.57	33.78
1587	132.4	140.9	37.57	33.77
1588	132.4	140.9	37.58	33.76
1589	132.4	140.9	37.58	33.75
1590	132.4	140.9	37.58	33.74
1591	132.5	140.9	37.59	33.73
1592	132.5	140.9	37.59	33.72
1593	132.5	140.9	37.59	33.71
1594	132.5	140.9	37.60	33.70
1595	132.5	140.9	37.60	33.69
1596	132.6	140.9	37.61	33.69
1597	132.6	140.9	37.61	33.68
1598	132.6	140.9	37.61	33.67
1599	132.6	140.9	37.62	33.66

室内ユニット 合計容量	能力 (kW)		入力 (kW)	
	冷房	暖房	冷房	暖房
1600	132.7	140.9	37.62	33.65
1601	132.7	140.9	37.62	33.64
1602	132.7	140.9	37.63	33.63
1603	132.7	140.9	37.63	33.62
1604	132.8	140.9	37.63	33.61
1605	132.8	140.9	37.64	33.60
1606	132.8	140.9	37.64	33.59
1607	132.8	140.9	37.64	33.59
1608	132.9	141.0	37.65	33.58
1609	132.9	141.0	37.65	33.57
1610	132.9	141.0	37.65	33.56
1611	132.9	141.0	37.66	33.55
1612	133.0	141.0	37.66	33.54

## 【PUHY-P1300SKM-E】

室内ユニット 合計容量	能力 (kW)		入力 (kW)	
	冷房	暖房	冷房	暖房
650	65.0	72.5	18.89	20.48
651	65.1	72.6	18.92	20.51
652	65.2	72.7	18.95	20.54
653	65.3	72.8	18.98	20.57
654	65.4	72.9	19.00	20.60
655	65.5	73.0	19.03	20.63
656	65.6	73.1	19.06	20.66
657	65.7	73.3	19.09	20.69
658	65.8	73.4	19.11	20.72
659	65.9	73.5	19.14	20.75
660	66.0	73.6	19.17	20.78
661	66.1	73.7	19.20	20.81
662	66.2	73.8	19.22	20.84
663	66.3	73.9	19.25	20.87
664	66.4	74.0	19.28	20.90
665	66.5	74.1	19.31	20.93
666	66.6	74.3	19.34	20.96
667	66.7	74.4	19.36	20.99
668	66.8	74.5	19.39	21.02
669	66.9	74.6	19.42	21.05
670	67.0	74.7	19.45	21.08
671	67.1	74.8	19.47	21.11
672	67.2	74.9	19.50	21.14
673	67.3	75.0	19.53	21.17
674	67.4	75.2	19.56	21.20
675	67.5	75.3	19.59	21.23
676	67.6	75.4	19.61	21.26
677	67.7	75.5	19.64	21.29
678	67.8	75.6	19.67	21.32
679	67.9	75.7	19.70	21.35
680	68.0	75.8	19.73	21.38
681	68.1	75.9	19.75	21.41
682	68.2	76.0	19.78	21.44
683	68.3	76.2	19.81	21.47
684	68.4	76.3	19.84	21.50
685	68.5	76.4	19.87	21.53
686	68.6	76.5	19.89	21.56
687	68.7	76.6	19.92	21.59
688	68.8	76.7	19.95	21.62
689	68.9	76.8	19.98	21.65
690	69.0	76.9	20.01	21.68
691	69.1	77.0	20.03	21.71
692	69.2	77.2	20.06	21.74
693	69.3	77.3	20.09	21.77
694	69.4	77.4	20.12	21.80
695	69.5	77.5	20.15	21.83
696	69.6	77.6	20.18	21.86
697	69.7	77.7	20.20	21.89
698	69.8	77.8	20.23	21.92
699	69.9	77.9	20.26	21.95
700	70.0	78.1	20.29	21.98
701	70.1	78.2	20.32	22.01
702	70.2	78.3	20.35	22.04
703	70.3	78.4	20.37	22.07
704	70.4	78.5	20.40	22.10
705	70.5	78.6	20.43	22.13
706	70.6	78.7	20.46	22.16
707	70.7	78.8	20.49	22.19
708	70.8	78.9	20.52	22.22
709	70.9	79.1	20.54	22.25
710	71.0	79.2	20.57	22.28
711	71.1	79.3	20.60	22.31
712	71.2	79.4	20.63	22.34
713	71.3	79.5	20.66	22.37
714	71.4	79.6	20.69	22.40
715	71.5	79.7	20.71	22.43
716	71.6	79.8	20.74	22.46
717	71.7	79.9	20.77	22.49
718	71.8	80.1	20.80	22.51
719	71.9	80.2	20.83	22.54

室内ユニット 合計容量	能力 (kW)		入力 (kW)	
	冷房	暖房	冷房	暖房
720	72.0	80.3	20.86	22.57
721	72.1	80.4	20.89	22.60
722	72.2	80.5	20.91	22.63
723	72.3	80.6	20.94	22.66
724	72.4	80.7	20.97	22.69
725	72.5	80.8	21.00	22.72
726	72.6	80.9	21.03	22.75
727	72.7	81.1	21.06	22.78
728	72.8	81.2	21.09	22.81
729	72.9	81.3	21.12	22.84
730	73.0	81.4	21.14	22.87
731	73.1	81.5	21.17	22.90
732	73.2	81.6	21.20	22.93
733	73.3	81.7	21.23	22.96
734	73.4	81.8	21.26	22.99
735	73.5	82.0	21.29	23.02
736	73.6	82.1	21.32	23.05
737	73.7	82.2	21.35	23.08
738	73.8	82.3	21.37	23.11
739	73.9	82.4	21.40	23.14
740	74.0	82.5	21.43	23.17
741	74.1	82.6	21.46	23.19
742	74.2	82.7	21.49	23.22
743	74.3	82.8	21.52	23.25
744	74.4	83.0	21.55	23.28
745	74.5	83.1	21.58	23.31
746	74.6	83.2	21.61	23.34
747	74.7	83.3	21.63	23.37
748	74.8	83.4	21.66	23.40
749	74.9	83.5	21.69	23.43
750	75.0	83.6	21.72	23.46
751	75.1	83.7	21.75	23.49
752	75.2	83.8	21.78	23.52
753	75.3	84.0	21.81	23.55
754	75.4	84.1	21.84	23.58
755	75.5	84.2	21.87	23.61
756	75.6	84.3	21.90	23.64
757	75.7	84.4	21.93	23.67
758	75.8	84.5	21.95	23.69
759	75.9	84.6	21.98	23.72
760	76.0	84.7	22.01	23.75
761	76.1	84.9	22.04	23.78
762	76.2	85.0	22.07	23.81
763	76.3	85.1	22.10	23.84
764	76.4	85.2	22.13	23.87
765	76.5	85.3	22.16	23.90
766	76.6	85.4	22.19	23.93
767	76.7	85.5	22.22	23.96
768	76.8	85.6	22.25	23.99
769	76.9	85.7	22.28	24.02
770	77.0	85.9	22.31	24.05
771	77.1	86.0	22.34	24.08
772	77.2	86.1	22.36	24.10
773	77.3	86.2	22.39	24.13
774	77.4	86.3	22.42	24.16
775	77.5	86.4	22.45	24.19
776	77.6	86.5	22.48	24.22
777	77.7	86.6	22.51	24.25
778	77.8	86.7	22.54	24.28
779	77.9	86.9	22.57	24.31
780	78.0	87.0	22.60	24.34
781	78.1	87.1	22.63	24.37
782	78.2	87.2	22.66	24.40
783	78.3	87.3	22.69	24.43
784	78.4	87.4	22.72	24.46
785	78.5	87.5	22.75	24.48
786	78.6	87.6	22.78	24.51
787	78.7	87.8	22.81	24.54
788	78.8	87.9	22.84	24.57
789	78.9	88.0	22.87	24.60

室内ユニット 合計容量	能力 (kW)		入力 (kW)	
	冷房	暖房	冷房	暖房
790	79.0	88.1	22.90	24.63
791	79.1	88.2	22.93	24.66
792	79.2	88.3	22.96	24.69
793	79.3	88.4	22.98	24.72
794	79.4	88.5	23.01	24.75
795	79.5	88.6	23.04	24.78
796	79.6	88.8	23.07	24.80
797	79.7	88.9	23.10	24.83
798	79.8	89.0	23.13	24.86
799	79.9	89.1	23.16	24.89
800	80.0	89.2	23.19	24.92
801	80.1	89.3	23.22	24.95
802	80.2	89.4	23.25	24.98
803	80.3	89.5	23.28	25.01
804	80.4	89.6	23.31	25.04
805	80.5	89.8	23.34	25.07
806	80.6	89.9	23.37	25.09
807	80.7	90.0	23.40	25.12
808	80.8	90.1	23.43	25.15
809	80.9	90.2	23.46	25.18
810	81.0	90.3	23.49	25.21
811	81.1	90.4	23.52	25.24
812	81.2	90.5	23.55	25.27
813	81.3	90.6	23.58	25.30
814	81.4	90.8	23.61	25.33
815	81.5	90.9	23.64	25.35
816	81.6	91.0	23.67	25.38
817	81.7	91.1	23.70	25.41
818	81.8	91.2	23.73	25.44
819	81.9	91.3	23.76	25.47
820	82.0	91.4	23.79	25.50
821	82.1	91.5	23.82	25.53
822	82.2	91.7	23.85	25.56
823	82.3	91.8	23.88	25.59
824	82.4	91.9	23.91	25.61
825	82.5	92.0	23.94	25.64
826	82.6	92.1	23.97	25.67
827	82.7	92.2	24.00	25.70
828	82.8	92.3	24.03	25.73
829	82.9	92.4	24.06	25.76
830	83.0	92.5	24.09	25.79
831	83.1	92.7	24.12	25.82
832	83.2	92.8	24.15	25.85
833	83.3	92.9	24.18	25.87
834	83.4	93.0	24.21	25.90
835	83.5	93.1	24.24	25.93
836	83.6	93.2	24.28	25.96
837	83.7	93.3	24.31	25.99
838	83.8	93.4	24.34	26.02
839	83.9	93.5	24.37	26.05
840	84.0	93.7	24.40	26.08
841	84.1	93.8	24.43	26.10
842	84.2	93.9	24.46	26.13
843	84.3	94.0	24.49	26.16
844	84.4	94.1	24.52	26.19
845	84.5	94.2	24.55	26.22
846	84.6	94.3	24.58	26.25
847	84.7	94.4	24.61	26.28
848	84.8	94.6	24.64	26.30
849	84.9	94.7	24.67	26.33
850	85.0	94.8	24.70	26.36
851	85.1	94.9	24.73	26.39
852	85.2	95.0	24.76	26.42
853	85.3	95.1	24.79	26.45
854	85.4	95.2	24.82	26.48
855	85.5	95.3	24.85	26.50
856	85.6	95.4	24.88	26.53
857	85.7	95.6	24.92	26.56
858	85.8	95.7	24.95	26.59
859	85.9	95.8	24.98	26.62

【PUHY-P1300SKM-E】

室内ユニット 合計容量	能力 (kW)		入力 (kW)	
	冷房	暖房	冷房	暖房
860	86.0	95.9	25.01	26.65
861	86.1	96.0	25.04	26.68
862	86.2	96.1	25.07	26.70
863	86.3	96.2	25.10	26.73
864	86.4	96.3	25.13	26.76
865	86.5	96.4	25.16	26.79
866	86.6	96.6	25.19	26.82
867	86.7	96.7	25.22	26.85
868	86.8	96.8	25.25	26.88
869	86.9	96.9	25.28	26.90
870	87.0	97.0	25.32	26.93
871	87.1	97.1	25.35	26.96
872	87.2	97.2	25.38	26.99
873	87.3	97.3	25.41	27.02
874	87.4	97.5	25.44	27.05
875	87.5	97.6	25.47	27.08
876	87.6	97.7	25.50	27.10
877	87.7	97.8	25.53	27.13
878	87.8	97.9	25.56	27.16
879	87.9	98.0	25.59	27.19
880	88.0	98.1	25.62	27.22
881	88.1	98.2	25.66	27.25
882	88.2	98.3	25.69	27.27
883	88.3	98.5	25.72	27.30
884	88.4	98.6	25.75	27.33
885	88.5	98.7	25.78	27.36
886	88.6	98.8	25.81	27.39
887	88.7	98.9	25.84	27.42
888	88.8	99.0	25.87	27.44
889	88.9	99.1	25.90	27.47
890	89.0	99.2	25.94	27.50
891	89.1	99.3	25.97	27.53
892	89.2	99.5	26.00	27.56
893	89.3	99.6	26.03	27.59
894	89.4	99.7	26.06	27.61
895	89.5	99.8	26.09	27.64
896	89.6	99.9	26.12	27.67
897	89.7	100.0	26.15	27.70
898	89.8	100.1	26.18	27.73
899	89.9	100.2	26.22	27.76
900	90.0	100.4	26.25	27.78
901	90.1	100.5	26.28	27.81
902	90.2	100.6	26.31	27.84
903	90.3	100.7	26.34	27.87
904	90.4	100.8	26.37	27.90
905	90.5	100.9	26.40	27.92
906	90.6	101.0	26.44	27.95
907	90.7	101.1	26.47	27.98
908	90.8	101.2	26.50	28.01
909	90.9	101.4	26.53	28.04
910	91.0	101.5	26.56	28.07
911	91.1	101.6	26.59	28.09
912	91.2	101.7	26.62	28.12
913	91.3	101.8	26.66	28.15
914	91.4	101.9	26.69	28.18
915	91.5	102.0	26.72	28.21
916	91.6	102.1	26.75	28.23
917	91.7	102.2	26.78	28.26
918	91.8	102.4	26.81	28.29
919	91.9	102.5	26.84	28.32
920	92.0	102.6	26.88	28.35
921	92.1	102.7	26.91	28.38
922	92.2	102.8	26.94	28.40
923	92.3	102.9	26.97	28.43
924	92.4	103.0	27.00	28.46
925	92.5	103.1	27.03	28.49
926	92.6	103.2	27.07	28.52
927	92.7	103.4	27.10	28.54
928	92.8	103.5	27.13	28.57
929	92.9	103.6	27.16	28.60

室内ユニット 合計容量	能力 (kW)		入力 (kW)	
	冷房	暖房	冷房	暖房
930	93.0	103.7	27.19	28.63
931	93.1	103.8	27.22	28.66
932	93.2	103.9	27.26	28.68
933	93.3	104.0	27.29	28.71
934	93.4	104.1	27.32	28.74
935	93.5	104.3	27.35	28.77
936	93.6	104.4	27.38	28.80
937	93.7	104.5	27.42	28.82
938	93.8	104.6	27.45	28.85
939	93.9	104.7	27.48	28.88
940	94.0	104.8	27.51	28.91
941	94.1	104.9	27.54	28.94
942	94.2	105.0	27.58	28.96
943	94.3	105.1	27.61	28.99
944	94.4	105.3	27.64	29.02
945	94.5	105.4	27.67	29.05
946	94.6	105.5	27.70	29.08
947	94.7	105.6	27.73	29.10
948	94.8	105.7	27.77	29.13
949	94.9	105.8	27.80	29.16
950	95.0	105.9	27.83	29.19
951	95.1	106.0	27.86	29.21
952	95.2	106.1	27.90	29.24
953	95.3	106.3	27.93	29.27
954	95.4	106.4	27.96	29.30
955	95.5	106.5	27.99	29.33
956	95.6	106.6	28.02	29.35
957	95.7	106.7	28.06	29.38
958	95.8	106.8	28.09	29.41
959	95.9	106.9	28.12	29.44
960	96.0	107.0	28.15	29.46
961	96.1	107.2	28.18	29.49
962	96.2	107.3	28.22	29.52
963	96.3	107.4	28.25	29.55
964	96.4	107.5	28.28	29.58
965	96.5	107.6	28.31	29.60
966	96.6	107.7	28.35	29.63
967	96.7	107.8	28.38	29.66
968	96.8	107.9	28.41	29.69
969	96.9	108.0	28.44	29.71
970	97.0	108.2	28.47	29.74
971	97.1	108.3	28.51	29.77
972	97.2	108.4	28.54	29.80
973	97.3	108.5	28.57	29.83
974	97.4	108.6	28.60	29.85
975	97.5	108.7	28.64	29.88
976	97.6	108.8	28.67	29.91
977	97.7	108.9	28.70	29.94
978	97.8	109.0	28.73	29.96
979	97.9	109.2	28.77	29.99
980	98.0	109.3	28.80	30.02
981	98.1	109.4	28.83	30.05
982	98.2	109.5	28.86	30.07
983	98.3	109.6	28.90	30.10
984	98.4	109.7	28.93	30.13
985	98.5	109.8	28.96	30.16
986	98.6	109.9	28.99	30.18
987	98.7	110.1	29.03	30.21
988	98.8	110.2	29.06	30.24
989	98.9	110.3	29.09	30.27
990	99.0	110.4	29.12	30.30
991	99.1	110.5	29.16	30.32
992	99.2	110.6	29.19	30.35
993	99.3	110.7	29.22	30.38
994	99.4	110.8	29.26	30.41
995	99.5	110.9	29.29	30.43
996	99.6	111.1	29.32	30.46
997	99.7	111.2	29.35	30.49
998	99.8	111.3	29.39	30.52
999	99.9	111.4	29.42	30.54

室内ユニット 合計容量	能力 (kW)		入力 (kW)	
	冷房	暖房	冷房	暖房
1000	100.0	111.5	29.45	30.57
1001	100.1	111.6	29.48	30.60
1002	100.2	111.7	29.52	30.63
1003	100.3	111.8	29.55	30.65
1004	100.4	111.9	29.58	30.68
1005	100.5	112.1	29.62	30.71
1006	100.6	112.2	29.65	30.73
1007	100.7	112.3	29.68	30.76
1008	100.8	112.4	29.71	30.79
1009	100.9	112.5	29.75	30.82
1010	101.0	112.6	29.78	30.84
1011	101.1	112.7	29.81	30.87
1012	101.2	112.8	29.85	30.90
1013	101.3	112.9	29.88	30.93
1014	101.4	113.1	29.91	30.95
1015	101.5	113.2	29.95	30.98
1016	101.6	113.3	29.98	31.01
1017	101.7	113.4	30.01	31.04
1018	101.8	113.5	30.04	31.06
1019	101.9	113.6	30.08	31.09
1020	102.0	113.7	30.11	31.12
1021	102.1	113.8	30.14	31.15
1022	102.2	114.0	30.18	31.17
1023	102.3	114.1	30.21	31.20
1024	102.4	114.2	30.24	31.23
1025	102.5	114.3	30.28	31.25
1026	102.6	114.4	30.31	31.28
1027	102.7	114.5	30.34	31.31
1028	102.8	114.6	30.38	31.34
1029	102.9	114.7	30.41	31.36
1030	103.0	114.8	30.44	31.39
1031	103.1	115.0	30.48	31.42
1032	103.2	115.1	30.51	31.45
1033	103.3	115.2	30.54	31.47
1034	103.4	115.3	30.58	31.50
1035	103.5	115.4	30.61	31.53
1036	103.6	115.5	30.64	31.55
1037	103.7	115.6	30.68	31.58
1038	103.8	115.7	30.71	31.61
1039	103.9	115.8	30.74	31.64
1040	104.0	116.0	30.78	31.66
1041	104.1	116.1	30.81	31.69
1042	104.2	116.2	30.84	31.72
1043	104.3	116.3	30.88	31.74
1044	104.4	116.4	30.91	31.77
1045	104.5	116.5	30.94	31.80
1046	104.6	116.6	30.98	31.83
1047	104.7	116.7	31.01	31.85
1048	104.8	116.9	31.04	31.88
1049	104.9	117.0	31.08	31.91
1050	105.0	117.1	31.11	31.93
1051	105.1	117.2	31.14	31.96
1052	105.2	117.3	31.18	31.99
1053	105.3	117.4	31.21	32.02
1054	105.4	117.5	31.24	32.04
1055	105.5	117.6	31.28	32.07
1056	105.6	117.7	31.31	32.10
1057	105.7	117.9	31.35	32.12
1058	105.8	118.0	31.38	32.15
1059	105.9	118.1	31.41	32.18
1060	106.0	118.2	31.45	32.20
1061	106.1	118.3	31.48	32.23
1062	106.2	118.4	31.51	32.26
1063	106.3	118.5	31.55	32.29
1064	106.4	118.6	31.58	32.31
1065	106.5	118.7	31.62	32.34
1066	106.6	118.9	31.65	32.37
1067	106.7	119.0	31.68	32.39
1068	106.8	119.1	31.72	32.42
1069	106.9	119.2	31.75	32.45

【PUHY-P1300SKM-E】

室内ユニット 合計容量	能力 (kW)		入力 (kW)	
	冷房	暖房	冷房	暖房
1070	107.0	119.3	31.78	32.47
1071	107.1	119.4	31.82	32.50
1072	107.2	119.5	31.85	32.53
1073	107.3	119.6	31.89	32.56
1074	107.4	119.8	31.92	32.58
1075	107.5	119.9	31.95	32.61
1076	107.6	120.0	31.99	32.64
1077	107.7	120.1	32.02	32.66
1078	107.8	120.2	32.06	32.69
1079	107.9	120.3	32.09	32.72
1080	108.0	120.4	32.12	32.74
1081	108.1	120.5	32.16	32.77
1082	108.2	120.6	32.19	32.80
1083	108.3	120.8	32.23	32.82
1084	108.4	120.9	32.26	32.85
1085	108.5	121.0	32.29	32.88
1086	108.6	121.1	32.33	32.90
1087	108.7	121.2	32.36	32.93
1088	108.8	121.3	32.40	32.96
1089	108.9	121.4	32.43	32.99
1090	109.0	121.5	32.46	33.01
1091	109.1	121.6	32.50	33.04
1092	109.2	121.8	32.53	33.07
1093	109.3	121.9	32.57	33.09
1094	109.4	122.0	32.60	33.12
1095	109.5	122.1	32.64	33.15
1096	109.6	122.2	32.67	33.17
1097	109.7	122.3	32.70	33.20
1098	109.8	122.4	32.74	33.23
1099	109.9	122.5	32.77	33.25
1100	110.0	122.7	32.81	33.28
1101	110.1	122.8	32.84	33.31
1102	110.2	122.9	32.88	33.33
1103	110.3	123.0	32.91	33.36
1104	110.4	123.1	32.94	33.39
1105	110.5	123.2	32.98	33.41
1106	110.6	123.3	33.01	33.44
1107	110.7	123.4	33.05	33.47
1108	110.8	123.5	33.08	33.49
1109	110.9	123.7	33.12	33.52
1110	111.0	123.8	33.15	33.55
1111	111.1	123.9	33.18	33.57
1112	111.2	124.0	33.22	33.60
1113	111.3	124.1	33.25	33.63
1114	111.4	124.2	33.29	33.65
1115	111.5	124.3	33.32	33.68
1116	111.6	124.4	33.36	33.71
1117	111.7	124.5	33.39	33.73
1118	111.8	124.7	33.43	33.76
1119	111.9	124.8	33.46	33.79
1120	112.0	124.9	33.50	33.81
1121	112.1	125.0	33.53	33.84
1122	112.2	125.1	33.56	33.87
1123	112.3	125.2	33.60	33.89
1124	112.4	125.3	33.63	33.92
1125	112.5	125.4	33.67	33.94
1126	112.6	125.5	33.70	33.97
1127	112.7	125.7	33.74	34.00
1128	112.8	125.8	33.77	34.02
1129	112.9	125.9	33.81	34.05
1130	113.0	126.0	33.84	34.08
1131	113.1	126.1	33.88	34.10
1132	113.2	126.2	33.91	34.13
1133	113.3	126.3	33.95	34.16
1134	113.4	126.4	33.98	34.18
1135	113.5	126.6	34.02	34.21
1136	113.6	126.7	34.05	34.24
1137	113.7	126.8	34.09	34.26
1138	113.8	126.9	34.12	34.29
1139	113.9	127.0	34.16	34.32

室内ユニット 合計容量	能力 (kW)		入力 (kW)	
	冷房	暖房	冷房	暖房
1140	114.0	127.1	34.19	34.34
1141	114.1	127.2	34.23	34.37
1142	114.2	127.3	34.26	34.39
1143	114.3	127.4	34.30	34.42
1144	114.4	127.6	34.33	34.45
1145	114.5	127.7	34.37	34.47
1146	114.6	127.8	34.40	34.50
1147	114.7	127.9	34.44	34.53
1148	114.8	128.0	34.47	34.55
1149	114.9	128.1	34.51	34.58
1150	115.0	128.2	34.54	34.61
1151	115.1	128.3	34.58	34.63
1152	115.2	128.4	34.61	34.66
1153	115.3	128.6	34.65	34.68
1154	115.4	128.7	34.68	34.71
1155	115.5	128.8	34.72	34.74
1156	115.6	128.9	34.75	34.76
1157	115.7	129.0	34.79	34.79
1158	115.8	129.1	34.82	34.82
1159	115.9	129.2	34.86	34.84
1160	116.0	129.3	34.89	34.87
1161	116.1	129.5	34.93	34.89
1162	116.2	129.6	34.96	34.92
1163	116.3	129.7	35.00	34.95
1164	116.4	129.8	35.03	34.97
1165	116.5	129.9	35.07	35.00
1166	116.6	130.0	35.10	35.03
1167	116.7	130.1	35.14	35.05
1168	116.8	130.2	35.17	35.08
1169	116.9	130.3	35.21	35.10
1170	117.0	130.5	35.24	35.13
1171	117.1	130.6	35.28	35.16
1172	117.2	130.7	35.31	35.18
1173	117.3	130.8	35.35	35.21
1174	117.4	130.9	35.39	35.23
1175	117.5	131.0	35.42	35.26
1176	117.6	131.1	35.46	35.29
1177	117.7	131.2	35.49	35.31
1178	117.8	131.3	35.53	35.34
1179	117.9	131.5	35.56	35.37
1180	118.0	131.6	35.60	35.39
1181	118.1	131.7	35.63	35.42
1182	118.2	131.8	35.67	35.44
1183	118.3	131.9	35.70	35.47
1184	118.4	132.0	35.74	35.50
1185	118.5	132.1	35.78	35.52
1186	118.6	132.2	35.81	35.55
1187	118.7	132.4	35.85	35.57
1188	118.8	132.5	35.88	35.60
1189	118.9	132.6	35.92	35.63
1190	119.0	132.7	35.95	35.65
1191	119.1	132.8	35.99	35.68
1192	119.2	132.9	36.03	35.70
1193	119.3	133.0	36.06	35.73
1194	119.4	133.1	36.10	35.76
1195	119.5	133.2	36.13	35.78
1196	119.6	133.4	36.17	35.81
1197	119.7	133.5	36.20	35.83
1198	119.8	133.6	36.24	35.86
1199	119.9	133.7	36.28	35.89
1200	120.0	133.8	36.31	35.91
1201	120.1	133.9	36.35	35.94
1202	120.2	134.0	36.38	35.96
1203	120.3	134.1	36.42	35.99
1204	120.4	134.2	36.45	36.02
1205	120.5	134.4	36.49	36.04
1206	120.6	134.5	36.53	36.07
1207	120.7	134.6	36.56	36.09
1208	120.8	134.7	36.60	36.12
1209	120.9	134.8	36.63	36.14

室内ユニット 合計容量	能力 (kW)		入力 (kW)	
	冷房	暖房	冷房	暖房
1210	121.0	134.9	36.67	36.17
1211	121.1	135.0	36.71	36.20
1212	121.2	135.1	36.74	36.22
1213	121.3	135.2	36.78	36.25
1214	121.4	135.4	36.81	36.27
1215	121.5	135.5	36.85	36.30
1216	121.6	135.6	36.89	36.33
1217	121.7	135.7	36.92	36.35
1218	121.8	135.8	36.96	36.38
1219	121.9	135.9	36.99	36.40
1220	122.0	136.0	37.03	36.43
1221	122.1	136.1	37.07	36.45
1222	122.2	136.3	37.10	36.48
1223	122.3	136.4	37.14	36.51
1224	122.4	136.5	37.17	36.53
1225	122.5	136.6	37.21	36.56
1226	122.6	136.7	37.25	36.58
1227	122.7	136.8	37.28	36.61
1228	122.8	136.9	37.32	36.63
1229	122.9	137.0	37.36	36.66
1230	123.0	137.1	37.39	36.69
1231	123.1	137.3	37.43	36.71
1232	123.2	137.4	37.46	36.74
1233	123.3	137.5	37.50	36.76
1234	123.4	137.6	37.54	36.79
1235	123.5	137.7	37.57	36.81
1236	123.6	137.8	37.61	36.84
1237	123.7	137.9	37.65	36.87
1238	123.8	138.0	37.68	36.89
1239	123.9	138.1	37.72	36.92
1240	124.0	138.3	37.76	36.94
1241	124.1	138.4	37.79	36.97
1242	124.2	138.5	37.83	36.99
1243	124.3	138.6	37.86	37.02
1244	124.4	138.7	37.90	37.05
1245	124.5	138.8	37.94	37.07
1246	124.6	138.9	37.97	37.10
1247	124.7	139.0	38.01	37.12
1248	124.8	139.2	38.05	37.15
1249	124.9	139.3	38.08	37.17
1250	125.0	139.4	38.12	37.20
1251	125.1	139.5	38.16	37.22
1252	125.2	139.6	38.19	37.25
1253	125.3	139.7	38.23	37.28
1254	125.4	139.8	38.27	37.30
1255	125.5	139.9	38.30	37.33
1256	125.6	140.0	38.34	37.35
1257	125.7	140.2	38.38	37.38
1258	125.8	140.3	38.41	37.40
1259	125.9	140.4	38.45	37.43
1260	126.0	140.5	38.49	37.45
1261	126.1	140.6	38.52	37.48
1262	126.2	140.7	38.56	37.50
1263	126.3	140.8	38.60	37.53
1264	126.4	140.9	38.63	37.56
1265	126.5	141.0	38.67	37.58
1266	126.6	141.2	38.71	37.61
1267	126.7	141.3	38.74	37.63
1268	126.8	141.4	38.78	37.66
1269	126.9	141.5	38.82	37.68
1270	127.0	141.6	38.85	37.71
1271	127.1	141.7	38.89	37.73
1272	127.2	141.8	38.93	37.76
1273	127.3	141.9	38.96	37.78
1274	127.4	142.1	39.00	37.81
1275	127.5	142.2	39.04	37.84
1276	127.6	142.3	39.08	37.86
1277	127.7	142.4	39.11	37.89
1278	127.8	142.5	39.15	37.91
1279	127.9	142.6	39.19	37.94



### 【PUHY-P1300SKM-E】

室内ユニット 合計容量	能力 (kW)		入力 (kW)	
	冷房	暖房	冷房	暖房
1280	128.0	142.7	39.22	37.96
1281	128.1	142.8	39.26	37.99
1282	128.2	142.9	39.30	38.01
1283	128.3	143.1	39.33	38.04
1284	128.4	143.2	39.37	38.06
1285	128.5	143.3	39.41	38.09
1286	128.6	143.4	39.45	38.11
1287	128.7	143.5	39.48	38.14
1288	128.8	143.6	39.52	38.16
1289	128.9	143.7	39.56	38.19
1290	129.0	143.8	39.59	38.21
1291	129.1	143.9	39.63	38.24
1292	129.2	144.1	39.67	38.26
1293	129.3	144.2	39.71	38.29
1294	129.4	144.3	39.74	38.32
1295	129.5	144.4	39.78	38.34
1296	129.6	144.5	39.82	38.37
1297	129.7	144.6	39.85	38.39
1298	129.8	144.7	39.89	38.42
1299	129.9	144.8	39.93	38.44
1300	130.0	145.0	39.96	38.46
1301	130.0	145.0	39.96	38.45
1302	130.0	145.0	39.97	38.44
1303	130.1	145.0	39.97	38.44
1304	130.1	145.0	39.97	38.43
1305	130.1	145.0	39.98	38.42
1306	130.1	145.0	39.98	38.41
1307	130.2	145.0	39.99	38.41
1308	130.2	145.0	39.99	38.40
1309	130.2	145.0	39.99	38.39
1310	130.2	145.0	40.00	38.38
1311	130.3	145.0	40.00	38.38
1312	130.3	145.0	40.01	38.37
1313	130.3	145.0	40.01	38.36
1314	130.3	145.1	40.02	38.35
1315	130.4	145.1	40.02	38.35
1316	130.4	145.1	40.02	38.34
1317	130.4	145.1	40.03	38.33
1318	130.4	145.1	40.03	38.32
1319	130.5	145.1	40.04	38.32
1320	130.5	145.1	40.04	38.31
1321	130.5	145.1	40.04	38.30
1322	130.5	145.1	40.05	38.29
1323	130.6	145.1	40.05	38.29
1324	130.6	145.1	40.06	38.28
1325	130.6	145.1	40.06	38.27
1326	130.6	145.1	40.06	38.26
1327	130.7	145.1	40.07	38.26
1328	130.7	145.1	40.07	38.25
1329	130.7	145.1	40.08	38.24
1330	130.7	145.2	40.08	38.23
1331	130.8	145.2	40.08	38.23
1332	130.8	145.2	40.09	38.22
1333	130.8	145.2	40.09	38.21
1334	130.8	145.2	40.10	38.20
1335	130.9	145.2	40.10	38.20
1336	130.9	145.2	40.10	38.19
1337	130.9	145.2	40.11	38.18
1338	130.9	145.2	40.11	38.17
1339	130.9	145.2	40.12	38.17
1340	131.0	145.2	40.12	38.16
1341	131.0	145.2	40.12	38.15
1342	131.0	145.2	40.13	38.14
1343	131.0	145.2	40.13	38.14
1344	131.1	145.2	40.14	38.13
1345	131.1	145.2	40.14	38.12
1346	131.1	145.3	40.14	38.11
1347	131.1	145.3	40.15	38.10
1348	131.2	145.3	40.15	38.10
1349	131.2	145.3	40.16	38.09

室内ユニット 合計容量	能力 (kW)		入力 (kW)	
	冷房	暖房	冷房	暖房
1350	131.2	145.3	40.16	38.08
1351	131.2	145.3	40.16	38.07
1352	131.3	145.3	40.17	38.07
1353	131.3	145.3	40.17	38.06
1354	131.3	145.3	40.18	38.05
1355	131.3	145.3	40.18	38.04
1356	131.4	145.3	40.19	38.04
1357	131.4	145.3	40.19	38.03
1358	131.4	145.3	40.19	38.02
1359	131.4	145.3	40.20	38.01
1360	131.5	145.3	40.20	38.01
1361	131.5	145.3	40.21	38.00
1362	131.5	145.4	40.21	37.99
1363	131.5	145.4	40.21	37.98
1364	131.6	145.4	40.22	37.98
1365	131.6	145.4	40.22	37.97
1366	131.6	145.4	40.23	37.96
1367	131.6	145.4	40.23	37.95
1368	131.7	145.4	40.23	37.95
1369	131.7	145.4	40.24	37.94
1370	131.7	145.4	40.24	37.93
1371	131.7	145.4	40.25	37.92
1372	131.8	145.4	40.25	37.92
1373	131.8	145.4	40.25	37.91
1374	131.8	145.4	40.26	37.90
1375	131.8	145.4	40.26	37.89
1376	131.9	145.4	40.27	37.89
1377	131.9	145.5	40.27	37.88
1378	131.9	145.5	40.27	37.87
1379	131.9	145.5	40.28	37.86
1380	131.9	145.5	40.28	37.86
1381	132.0	145.5	40.29	37.85
1382	132.0	145.5	40.29	37.84
1383	132.0	145.5	40.29	37.83
1384	132.0	145.5	40.30	37.83
1385	132.1	145.5	40.30	37.82
1386	132.1	145.5	40.31	37.81
1387	132.1	145.5	40.31	37.80
1388	132.1	145.5	40.31	37.80
1389	132.2	145.5	40.32	37.79
1390	132.2	145.5	40.32	37.78
1391	132.2	145.5	40.33	37.77
1392	132.2	145.5	40.33	37.77
1393	132.3	145.6	40.33	37.76
1394	132.3	145.6	40.34	37.75
1395	132.3	145.6	40.34	37.74
1396	132.3	145.6	40.35	37.74
1397	132.4	145.6	40.35	37.73
1398	132.4	145.6	40.35	37.72
1399	132.4	145.6	40.36	37.71
1400	132.4	145.6	40.36	37.71
1401	132.5	145.6	40.37	37.70
1402	132.5	145.6	40.37	37.69
1403	132.5	145.6	40.38	37.68
1404	132.5	145.6	40.38	37.68
1405	132.6	145.6	40.38	37.67
1406	132.6	145.6	40.39	37.66
1407	132.6	145.6	40.39	37.65
1408	132.6	145.6	40.40	37.65
1409	132.7	145.7	40.40	37.64
1410	132.7	145.7	40.40	37.63
1411	132.7	145.7	40.41	37.62
1412	132.7	145.7	40.41	37.61
1413	132.8	145.7	40.42	37.61
1414	132.8	145.7	40.42	37.60
1415	132.8	145.7	40.42	37.59
1416	132.8	145.7	40.43	37.58
1417	132.9	145.7	40.43	37.58
1418	132.9	145.7	40.44	37.57
1419	132.9	145.7	40.44	37.56

室内ユニット 合計容量	能力 (kW)		入力 (kW)	
	冷房	暖房	冷房	暖房
1420	132.9	145.7	40.44	37.55
1421	132.9	145.7	40.45	37.55
1422	133.0	145.7	40.45	37.54
1423	133.0	145.7	40.46	37.53
1424	133.0	145.7	40.46	37.52
1425	133.0	145.8	40.46	37.52
1426	133.1	145.8	40.47	37.51
1427	133.1	145.8	40.47	37.50
1428	133.1	145.8	40.48	37.49
1429	133.1	145.8	40.48	37.49
1430	133.2	145.8	40.48	37.48
1431	133.2	145.8	40.49	37.47
1432	133.2	145.8	40.49	37.46
1433	133.2	145.8	40.50	37.46
1434	133.3	145.8	40.50	37.45
1435	133.3	145.8	40.50	37.44
1436	133.3	145.8	40.51	37.43
1437	133.3	145.8	40.51	37.43
1438	133.4	145.8	40.52	37.42
1439	133.4	145.8	40.52	37.41
1440	133.4	145.8	40.52	37.40
1441	133.4	145.9	40.53	37.40
1442	133.5	145.9	40.53	37.39
1443	133.5	145.9	40.54	37.38
1444	133.5	145.9	40.54	37.37
1445	133.5	145.9	40.55	37.37
1446	133.6	145.9	40.55	37.36
1447	133.6	145.9	40.55	37.35
1448	133.6	145.9	40.56	37.34
1449	133.6	145.9	40.56	37.34
1450	133.7	145.9	40.57	37.33
1451	133.7	145.9	40.57	37.32
1452	133.7	145.9	40.57	37.31
1453	133.7	145.9	40.58	37.31
1454	133.8	145.9	40.58	37.30
1455	133.8	145.9	40.59	37.29
1456	133.8	145.9	40.59	37.28
1457	133.8	146.0	40.59	37.28
1458	133.9	146.0	40.60	37.27
1459	133.9	146.0	40.60	37.26
1460	133.9	146.0	40.61	37.25
1461	133.9	146.0	40.61	37.25
1462	133.9	146.0	40.61	37.24
1463	134.0	146.0	40.62	37.23
1464	134.0	146.0	40.62	37.22
1465	134.0	146.0	40.63	37.22
1466	134.0	146.0	40.63	37.21
1467	134.1	146.0	40.63	37.20
1468	134.1	146.0	40.64	37.19
1469	134.1	146.0	40.64	37.19
1470	134.1	146.0	40.65	37.18
1471	134.2	146.0	40.65	37.17
1472	134.2	146.0	40.65	37.16
1473	134.2	146.1	40.66	37.16
1474	134.2	146.1	40.66	37.15
1475	134.3	146.1	40.67	37.14
1476	134.3	146.1	40.67	37.13
1477	134.3	146.1	40.67	37.12
1478	134.3	146.1	40.68	37.12
1479	134.4	146.1	40.68	37.11
1480	134.4	146.1	40.69	37.10
1481	134.4	146.1	40.69	37.09
1482	134.4	146.1	40.69	37.09
1483	134.5	146.1	40.70	37.08
1484	134.5	146.1	40.70	37.07
1485	134.5	146.1	40.71	37.06
1486	134.5	146.1	40.71	37.06
1487	134.6	146.1	40.71	37.05
1488	134.6	146.1	40.72	37.04
1489	134.6	146.2	40.72	37.03

## 【PUHY-P1300SKM-E】

室内ユニット 合計容量	能力 (kW)		入力 (kW)	
	冷房	暖房	冷房	暖房
1490	134.6	146.2	40.73	37.03
1491	134.7	146.2	40.73	37.02
1492	134.7	146.2	40.74	37.01
1493	134.7	146.2	40.74	37.00
1494	134.7	146.2	40.74	37.00
1495	134.8	146.2	40.75	36.99
1496	134.8	146.2	40.75	36.98
1497	134.8	146.2	40.76	36.97
1498	134.8	146.2	40.76	36.97
1499	134.9	146.2	40.76	36.96
1500	134.9	146.2	40.77	36.95
1501	134.9	146.2	40.77	36.94
1502	134.9	146.2	40.78	36.94
1503	134.9	146.2	40.78	36.93
1504	135.0	146.2	40.78	36.92
1505	135.0	146.3	40.79	36.91
1506	135.0	146.3	40.79	36.91
1507	135.0	146.3	40.80	36.90
1508	135.1	146.3	40.80	36.89
1509	135.1	146.3	40.80	36.88
1510	135.1	146.3	40.81	36.88
1511	135.1	146.3	40.81	36.87
1512	135.2	146.3	40.82	36.86
1513	135.2	146.3	40.82	36.85
1514	135.2	146.3	40.82	36.85
1515	135.2	146.3	40.83	36.84
1516	135.3	146.3	40.83	36.83
1517	135.3	146.3	40.84	36.82
1518	135.3	146.3	40.84	36.82
1519	135.3	146.3	40.84	36.81
1520	135.4	146.3	40.85	36.80
1521	135.4	146.4	40.85	36.79
1522	135.4	146.4	40.86	36.79
1523	135.4	146.4	40.86	36.78
1524	135.5	146.4	40.86	36.77
1525	135.5	146.4	40.87	36.76
1526	135.5	146.4	40.87	36.76
1527	135.5	146.4	40.88	36.75
1528	135.6	146.4	40.88	36.74
1529	135.6	146.4	40.88	36.73
1530	135.6	146.4	40.89	36.73
1531	135.6	146.4	40.89	36.72
1532	135.7	146.4	40.90	36.71
1533	135.7	146.4	40.90	36.70
1534	135.7	146.4	40.91	36.70
1535	135.7	146.4	40.91	36.69
1536	135.8	146.4	40.91	36.68
1537	135.8	146.5	40.92	36.67
1538	135.8	146.5	40.92	36.67
1539	135.8	146.5	40.93	36.66
1540	135.9	146.5	40.93	36.65
1541	135.9	146.5	40.93	36.64
1542	135.9	146.5	40.94	36.63
1543	135.9	146.5	40.94	36.63
1544	135.9	146.5	40.95	36.62
1545	136.0	146.5	40.95	36.61
1546	136.0	146.5	40.95	36.60
1547	136.0	146.5	40.96	36.60
1548	136.0	146.5	40.96	36.59
1549	136.1	146.5	40.97	36.58
1550	136.1	146.5	40.97	36.57
1551	136.1	146.5	40.97	36.57
1552	136.1	146.5	40.98	36.56
1553	136.2	146.6	40.98	36.55
1554	136.2	146.6	40.99	36.54
1555	136.2	146.6	40.99	36.54
1556	136.2	146.6	40.99	36.53
1557	136.3	146.6	41.00	36.52
1558	136.3	146.6	41.00	36.51
1559	136.3	146.6	41.01	36.51

室内ユニット 合計容量	能力 (kW)		入力 (kW)	
	冷房	暖房	冷房	暖房
1560	136.3	146.6	41.01	36.50
1561	136.4	146.6	41.01	36.49
1562	136.4	146.6	41.02	36.48
1563	136.4	146.6	41.02	36.48
1564	136.4	146.6	41.03	36.47
1565	136.5	146.6	41.03	36.46
1566	136.5	146.6	41.03	36.45
1567	136.5	146.6	41.04	36.45
1568	136.5	146.7	41.04	36.44
1569	136.6	146.7	41.05	36.43
1570	136.6	146.7	41.05	36.42
1571	136.6	146.7	41.05	36.42
1572	136.6	146.7	41.06	36.41
1573	136.7	146.7	41.06	36.40
1574	136.7	146.7	41.07	36.39
1575	136.7	146.7	41.07	36.39
1576	136.7	146.7	41.07	36.38
1577	136.8	146.7	41.08	36.37
1578	136.8	146.7	41.08	36.36
1579	136.8	146.7	41.09	36.36
1580	136.8	146.7	41.09	36.35
1581	136.9	146.7	41.10	36.34
1582	136.9	146.7	41.10	36.33
1583	136.9	146.7	41.10	36.33
1584	136.9	146.8	41.11	36.32
1585	136.9	146.8	41.11	36.31
1586	137.0	146.8	41.12	36.30
1587	137.0	146.8	41.12	36.30
1588	137.0	146.8	41.12	36.29
1589	137.0	146.8	41.13	36.28
1590	137.1	146.8	41.13	36.27
1591	137.1	146.8	41.14	36.27
1592	137.1	146.8	41.14	36.26
1593	137.1	146.8	41.14	36.25
1594	137.2	146.8	41.15	36.24
1595	137.2	146.8	41.15	36.24
1596	137.2	146.8	41.16	36.23
1597	137.2	146.8	41.16	36.22
1598	137.3	146.8	41.16	36.21
1599	137.3	146.8	41.17	36.21
1600	137.3	146.9	41.17	36.20
1601	137.3	146.9	41.18	36.19
1602	137.4	146.9	41.18	36.18
1603	137.4	146.9	41.18	36.17
1604	137.4	146.9	41.19	36.17
1605	137.4	146.9	41.19	36.16
1606	137.5	146.9	41.20	36.15
1607	137.5	146.9	41.20	36.14
1608	137.5	146.9	41.20	36.14
1609	137.5	146.9	41.21	36.13
1610	137.6	146.9	41.21	36.12
1611	137.6	146.9	41.22	36.11
1612	137.6	146.9	41.22	36.11
1613	137.6	146.9	41.22	36.10
1614	137.7	146.9	41.23	36.09
1615	137.7	146.9	41.23	36.08
1616	137.7	147.0	41.24	36.08
1617	137.7	147.0	41.24	36.07
1618	137.8	147.0	41.24	36.06
1619	137.8	147.0	41.25	36.05
1620	137.8	147.0	41.25	36.05
1621	137.8	147.0	41.26	36.04
1622	137.9	147.0	41.26	36.03
1623	137.9	147.0	41.27	36.02
1624	137.9	147.0	41.27	36.02
1625	137.9	147.0	41.27	36.01
1626	137.9	147.0	41.28	36.00
1627	138.0	147.0	41.28	35.99
1628	138.0	147.0	41.29	35.99
1629	138.0	147.0	41.29	35.98

室内ユニット 合計容量	能力 (kW)		入力 (kW)	
	冷房	暖房	冷房	暖房
1630	138.0	147.0	41.29	35.97
1631	138.1	147.0	41.30	35.96
1632	138.1	147.1	41.30	35.96
1633	138.1	147.1	41.31	35.95
1634	138.1	147.1	41.31	35.94
1635	138.2	147.1	41.31	35.93
1636	138.2	147.1	41.32	35.93
1637	138.2	147.1	41.32	35.92
1638	138.2	147.1	41.33	35.91
1639	138.3	147.1	41.33	35.90
1640	138.3	147.1	41.33	35.90
1641	138.3	147.1	41.34	35.89
1642	138.3	147.1	41.34	35.88
1643	138.4	147.1	41.35	35.87
1644	138.4	147.1	41.35	35.87
1645	138.4	147.1	41.35	35.86
1646	138.4	147.1	41.36	35.85
1647	138.5	147.1	41.36	35.84
1648	138.5	147.2	41.37	35.84
1649	138.5	147.2	41.37	35.83
1650	138.5	147.2	41.37	35.82
1651	138.6	147.2	41.38	35.81
1652	138.6	147.2	41.38	35.81
1653	138.6	147.2	41.39	35.80
1654	138.6	147.2	41.39	35.79
1655	138.7	147.2	41.39	35.78
1656	138.7	147.2	41.40	35.78
1657	138.7	147.2	41.40	35.77
1658	138.7	147.2	41.41	35.76
1659	138.8	147.2	41.41	35.75
1660	138.8	147.2	41.41	35.75
1661	138.8	147.2	41.42	35.74
1662	138.8	147.2	41.42	35.73
1663	138.9	147.2	41.43	35.72
1664	138.9	147.3	41.43	35.72
1665	138.9	147.3	41.43	35.71
1666	138.9	147.3	41.44	35.70
1667	138.9	147.3	41.44	35.69
1668	139.0	147.3	41.45	35.68
1669	139.0	147.3	41.45	35.68
1670	139.0	147.3	41.46	35.67
1671	139.0	147.3	41.46	35.66
1672	139.1	147.3	41.46	35.65
1673	139.1	147.3	41.47	35.65
1674	139.1	147.3	41.47	35.64
1675	139.1	147.3	41.48	35.63
1676	139.2	147.3	41.48	35.62
1677	139.2	147.3	41.48	35.62
1678	139.2	147.3	41.49	35.61
1679	139.2	147.3	41.49	35.60
1680	139.3	147.4	41.50	35.59
1681	139.3	147.4	41.50	35.59
1682	139.3	147.4	41.50	35.58
1683	139.3	147.4	41.51	35.57
1684	139.4	147.4	41.51	35.56
1685	139.4	147.4	41.52	35.56
1686	139.4	147.4	41.52	35.55
1687	139.4	147.4	41.52	35.54
1688	139.5	147.4	41.53	35.53
1689	139.5	147.4	41.53	35.53
1690	139.5	147.4	41.54	35.52

**【PUHY-P1360SKM-E】**

室内ユニット 合計容量	能力 (kW)		入力 (kW)	
	冷房	暖房	冷房	暖房
680	68.0	75.0	19.69	21.31
681	68.1	75.1	19.71	21.34
682	68.2	75.2	19.73	21.37
683	68.3	75.3	19.76	21.40
684	68.4	75.4	19.78	21.43
685	68.5	75.6	19.80	21.46
686	68.6	75.7	19.83	21.49
687	68.7	75.8	19.85	21.52
688	68.8	75.9	19.88	21.55
689	68.9	76.0	19.90	21.58
690	69.0	76.1	19.92	21.61
691	69.1	76.2	19.95	21.64
692	69.2	76.3	19.97	21.67
693	69.3	76.4	20.00	21.70
694	69.4	76.5	20.02	21.73
695	69.5	76.7	20.05	21.76
696	69.6	76.8	20.07	21.79
697	69.7	76.9	20.09	21.82
698	69.8	77.0	20.12	21.85
699	69.9	77.1	20.14	21.88
700	70.0	77.2	20.17	21.91
701	70.1	77.3	20.19	21.94
702	70.2	77.4	20.22	21.97
703	70.3	77.5	20.24	22.00
704	70.4	77.7	20.26	22.03
705	70.5	77.8	20.29	22.06
706	70.6	77.9	20.31	22.09
707	70.7	78.0	20.34	22.12
708	70.8	78.1	20.36	22.15
709	70.9	78.2	20.39	22.18
710	71.0	78.3	20.41	22.21
711	71.1	78.4	20.44	22.24
712	71.2	78.5	20.46	22.27
713	71.3	78.6	20.49	22.30
714	71.4	78.8	20.51	22.33
715	71.5	78.9	20.54	22.36
716	71.6	79.0	20.56	22.39
717	71.7	79.1	20.59	22.42
718	71.8	79.2	20.61	22.45
719	71.9	79.3	20.64	22.48
720	72.0	79.4	20.66	22.51
721	72.1	79.5	20.69	22.54
722	72.2	79.6	20.71	22.56
723	72.3	79.7	20.74	22.59
724	72.4	79.9	20.76	22.62
725	72.5	80.0	20.79	22.65
726	72.6	80.1	20.81	22.68
727	72.7	80.2	20.84	22.71
728	72.8	80.3	20.86	22.74
729	72.9	80.4	20.89	22.77
730	73.0	80.5	20.92	22.80
731	73.1	80.6	20.94	22.83
732	73.2	80.7	20.97	22.86
733	73.3	80.8	20.99	22.89
734	73.4	81.0	21.02	22.92
735	73.5	81.1	21.04	22.95
736	73.6	81.2	21.07	22.98
737	73.7	81.3	21.10	23.01
738	73.8	81.4	21.12	23.04
739	73.9	81.5	21.15	23.07
740	74.0	81.6	21.17	23.10
741	74.1	81.7	21.20	23.13
742	74.2	81.8	21.22	23.16
743	74.3	82.0	21.25	23.19
744	74.4	82.1	21.28	23.22
745	74.5	82.2	21.30	23.25
746	74.6	82.3	21.33	23.27
747	74.7	82.4	21.36	23.30
748	74.8	82.5	21.38	23.33
749	74.9	82.6	21.41	23.36

室内ユニット 合計容量	能力 (kW)		入力 (kW)	
	冷房	暖房	冷房	暖房
750	75.0	82.7	21.43	23.39
751	75.1	82.8	21.46	23.42
752	75.2	82.9	21.49	23.45
753	75.3	83.1	21.51	23.48
754	75.4	83.2	21.54	23.51
755	75.5	83.3	21.57	23.54
756	75.6	83.4	21.59	23.57
757	75.7	83.5	21.62	23.60
758	75.8	83.6	21.65	23.63
759	75.9	83.7	21.67	23.66
760	76.0	83.8	21.70	23.69
761	76.1	83.9	21.73	23.72
762	76.2	84.0	21.75	23.74
763	76.3	84.2	21.78	23.77
764	76.4	84.3	21.81	23.80
765	76.5	84.4	21.83	23.83
766	76.6	84.5	21.86	23.86
767	76.7	84.6	21.89	23.89
768	76.8	84.7	21.91	23.92
769	76.9	84.8	21.94	23.95
770	77.0	84.9	21.97	23.98
771	77.1	85.0	21.99	24.01
772	77.2	85.2	22.02	24.04
773	77.3	85.3	22.05	24.07
774	77.4	85.4	22.08	24.10
775	77.5	85.5	22.10	24.13
776	77.6	85.6	22.13	24.15
777	77.7	85.7	22.16	24.18
778	77.8	85.8	22.18	24.21
779	77.9	85.9	22.21	24.24
780	78.0	86.0	22.24	24.27
781	78.1	86.1	22.27	24.30
782	78.2	86.3	22.29	24.33
783	78.3	86.4	22.32	24.36
784	78.4	86.5	22.35	24.39
785	78.5	86.6	22.38	24.42
786	78.6	86.7	22.40	24.45
787	78.7	86.8	22.43	24.48
788	78.8	86.9	22.46	24.50
789	78.9	87.0	22.49	24.53
790	79.0	87.1	22.51	24.56
791	79.1	87.2	22.54	24.59
792	79.2	87.4	22.57	24.62
793	79.3	87.5	22.60	24.65
794	79.4	87.6	22.63	24.68
795	79.5	87.7	22.65	24.71
796	79.6	87.8	22.68	24.74
797	79.7	87.9	22.71	24.77
798	79.8	88.0	22.74	24.80
799	79.9	88.1	22.77	24.82
800	80.0	88.2	22.79	24.85
801	80.1	88.4	22.82	24.88
802	80.2	88.5	22.85	24.91
803	80.3	88.6	22.88	24.94
804	80.4	88.7	22.91	24.97
805	80.5	88.8	22.94	25.00
806	80.6	88.9	22.96	25.03
807	80.7	89.0	22.99	25.06
808	80.8	89.1	23.02	25.08
809	80.9	89.2	23.05	25.11
810	81.0	89.3	23.08	25.14
811	81.1	89.5	23.11	25.17
812	81.2	89.6	23.13	25.20
813	81.3	89.7	23.16	25.23
814	81.4	89.8	23.19	25.26
815	81.5	89.9	23.22	25.29
816	81.6	90.0	23.25	25.32
817	81.7	90.1	23.28	25.34
818	81.8	90.2	23.31	25.37
819	81.9	90.3	23.34	25.40

室内ユニット 合計容量	能力 (kW)		入力 (kW)	
	冷房	暖房	冷房	暖房
820	82.0	90.4	23.36	25.43
821	82.1	90.6	23.39	25.46
822	82.2	90.7	23.42	25.49
823	82.3	90.8	23.45	25.52
824	82.4	90.9	23.48	25.55
825	82.5	91.0	23.51	25.58
826	82.6	91.1	23.54	25.60
827	82.7	91.2	23.57	25.63
828	82.8	91.3	23.60	25.66
829	82.9	91.4	23.63	25.69
830	83.0	91.5	23.66	25.72
831	83.1	91.7	23.68	25.75
832	83.2	91.8	23.71	25.78
833	83.3	91.9	23.74	25.81
834	83.4	92.0	23.77	25.83
835	83.5	92.1	23.80	25.86
836	83.6	92.2	23.83	25.89
837	83.7	92.3	23.86	25.92
838	83.8	92.4	23.89	25.95
839	83.9	92.5	23.92	25.98
840	84.0	92.7	23.95	26.01
841	84.1	92.8	23.98	26.03
842	84.2	92.9	24.01	26.06
843	84.3	93.0	24.04	26.09
844	84.4	93.1	24.07	26.12
845	84.5	93.2	24.10	26.15
846	84.6	93.3	24.13	26.18
847	84.7	93.4	24.16	26.21
848	84.8	93.5	24.19	26.23
849	84.9	93.6	24.22	26.26
850	85.0	93.8	24.25	26.29
851	85.1	93.9	24.28	26.32
852	85.2	94.0	24.31	26.35
853	85.3	94.1	24.34	26.38
854	85.4	94.2	24.37	26.41
855	85.5	94.3	24.40	26.43
856	85.6	94.4	24.43	26.46
857	85.7	94.5	24.46	26.49
858	85.8	94.6	24.49	26.52
859	85.9	94.7	24.52	26.55
860	86.0	94.9	24.55	26.58
861	86.1	95.0	24.58	26.61
862	86.2	95.1	24.61	26.63
863	86.3	95.2	24.64	26.66
864	86.4	95.3	24.67	26.69
865	86.5	95.4	24.70	26.72
866	86.6	95.5	24.73	26.75
867	86.7	95.6	24.76	26.78
868	86.8	95.7	24.79	26.80
869	86.9	95.9	24.82	26.83
870	87.0	96.0	24.86	26.86
871	87.1	96.1	24.89	26.89
872	87.2	96.2	24.92	26.92
873	87.3	96.3	24.95	26.95
874	87.4	96.4	24.98	26.97
875	87.5	96.5	25.01	27.00
876	87.6	96.6	25.04	27.03
877	87.7	96.7	25.07	27.06
878	87.8	96.8	25.10	27.09
879	87.9	97.0	25.13	27.12
880	88.0	97.1	25.16	27.14
881	88.1	97.2	25.20	27.17
882	88.2	97.3	25.23	27.20
883	88.3	97.4	25.26	27.23
884	88.4	97.5	25.29	27.26
885	88.5	97.6	25.32	27.29
886	88.6	97.7	25.35	27.31
887	88.7	97.8	25.38	27.34
888	88.8	97.9	25.41	27.37
889	88.9	98.1	25.45	27.40

【PUHY-P1360SKM-E】

室内ユニット 合計容量	能力 (kW)		入力 (kW)	
	冷房	暖房	冷房	暖房
890	89.0	98.2	25.48	27.43
891	89.1	98.3	25.51	27.46
892	89.2	98.4	25.54	27.48
893	89.3	98.5	25.57	27.51
894	89.4	98.6	25.60	27.54
895	89.5	98.7	25.64	27.57
896	89.6	98.8	25.67	27.60
897	89.7	98.9	25.70	27.62
898	89.8	99.0	25.73	27.65
899	89.9	99.2	25.76	27.68
900	90.0	99.3	25.79	27.71
901	90.1	99.4	25.83	27.74
902	90.2	99.5	25.86	27.77
903	90.3	99.6	25.89	27.79
904	90.4	99.7	25.92	27.82
905	90.5	99.8	25.95	27.85
906	90.6	99.9	25.99	27.88
907	90.7	100.0	26.02	27.91
908	90.8	100.2	26.05	27.93
909	90.9	100.3	26.08	27.96
910	91.0	100.4	26.11	27.99
911	91.1	100.5	26.15	28.02
912	91.2	100.6	26.18	28.05
913	91.3	100.7	26.21	28.07
914	91.4	100.8	26.24	28.10
915	91.5	100.9	26.28	28.13
916	91.6	101.0	26.31	28.16
917	91.7	101.1	26.34	28.19
918	91.8	101.3	26.37	28.21
919	91.9	101.4	26.41	28.24
920	92.0	101.5	26.44	28.27
921	92.1	101.6	26.47	28.30
922	92.2	101.7	26.50	28.33
923	92.3	101.8	26.54	28.35
924	92.4	101.9	26.57	28.38
925	92.5	102.0	26.60	28.41
926	92.6	102.1	26.64	28.44
927	92.7	102.2	26.67	28.47
928	92.8	102.4	26.70	28.49
929	92.9	102.5	26.73	28.52
930	93.0	102.6	26.77	28.55
931	93.1	102.7	26.80	28.58
932	93.2	102.8	26.83	28.60
933	93.3	102.9	26.87	28.63
934	93.4	103.0	26.90	28.66
935	93.5	103.1	26.93	28.69
936	93.6	103.2	26.97	28.72
937	93.7	103.4	27.00	28.74
938	93.8	103.5	27.03	28.77
939	93.9	103.6	27.07	28.80
940	94.0	103.7	27.10	28.83
941	94.1	103.8	27.13	28.85
942	94.2	103.9	27.17	28.88
943	94.3	104.0	27.20	28.91
944	94.4	104.1	27.23	28.94
945	94.5	104.2	27.27	28.97
946	94.6	104.3	27.30	28.99
947	94.7	104.5	27.33	29.02
948	94.8	104.6	27.37	29.05
949	94.9	104.7	27.40	29.08
950	95.0	104.8	27.43	29.10
951	95.1	104.9	27.47	29.13
952	95.2	105.0	27.50	29.16
953	95.3	105.1	27.54	29.19
954	95.4	105.2	27.57	29.22
955	95.5	105.3	27.60	29.24
956	95.6	105.4	27.64	29.27
957	95.7	105.6	27.67	29.30
958	95.8	105.7	27.71	29.33
959	95.9	105.8	27.74	29.35

室内ユニット 合計容量	能力 (kW)		入力 (kW)	
	冷房	暖房	冷房	暖房
960	96.0	105.9	27.77	29.38
961	96.1	106.0	27.81	29.41
962	96.2	106.1	27.84	29.44
963	96.3	106.2	27.88	29.46
964	96.4	106.3	27.91	29.49
965	96.5	106.4	27.94	29.52
966	96.6	106.5	27.98	29.55
967	96.7	106.7	28.01	29.57
968	96.8	106.8	28.05	29.60
969	96.9	106.9	28.08	29.63
970	97.0	107.0	28.12	29.66
971	97.1	107.1	28.15	29.68
972	97.2	107.2	28.19	29.71
973	97.3	107.3	28.22	29.74
974	97.4	107.4	28.25	29.77
975	97.5	107.5	28.29	29.79
976	97.6	107.7	28.32	29.82
977	97.7	107.8	28.36	29.85
978	97.8	107.9	28.39	29.88
979	97.9	108.0	28.43	29.90
980	98.0	108.1	28.46	29.93
981	98.1	108.2	28.50	29.96
982	98.2	108.3	28.53	29.99
983	98.3	108.4	28.57	30.01
984	98.4	108.5	28.60	30.04
985	98.5	108.6	28.64	30.07
986	98.6	108.8	28.67	30.10
987	98.7	108.9	28.71	30.12
988	98.8	109.0	28.74	30.15
989	98.9	109.1	28.78	30.18
990	99.0	109.2	28.81	30.21
991	99.1	109.3	28.85	30.23
992	99.2	109.4	28.88	30.26
993	99.3	109.5	28.92	30.29
994	99.4	109.6	28.95	30.31
995	99.5	109.7	28.99	30.34
996	99.6	109.9	29.02	30.37
997	99.7	110.0	29.06	30.40
998	99.8	110.1	29.10	30.42
999	99.9	110.2	29.13	30.45
1000	100.0	110.3	29.17	30.48
1001	100.1	110.4	29.20	30.51
1002	100.2	110.5	29.24	30.53
1003	100.3	110.6	29.27	30.56
1004	100.4	110.7	29.31	30.59
1005	100.5	110.9	29.35	30.61
1006	100.6	111.0	29.38	30.64
1007	100.7	111.1	29.42	30.67
1008	100.8	111.2	29.45	30.70
1009	100.9	111.3	29.49	30.72
1010	101.0	111.4	29.52	30.75
1011	101.1	111.5	29.56	30.78
1012	101.2	111.6	29.60	30.80
1013	101.3	111.7	29.63	30.83
1014	101.4	111.8	29.67	30.86
1015	101.5	112.0	29.70	30.89
1016	101.6	112.1	29.74	30.91
1017	101.7	112.2	29.78	30.94
1018	101.8	112.3	29.81	30.97
1019	101.9	112.4	29.85	30.99
1020	102.0	112.5	29.89	31.02
1021	102.1	112.6	29.92	31.05
1022	102.2	112.7	29.96	31.08
1023	102.3	112.8	30.00	31.10
1024	102.4	112.9	30.03	31.13
1025	102.5	113.1	30.07	31.16
1026	102.6	113.2	30.10	31.18
1027	102.7	113.3	30.14	31.21
1028	102.8	113.4	30.18	31.24
1029	102.9	113.5	30.21	31.26

室内ユニット 合計容量	能力 (kW)		入力 (kW)	
	冷房	暖房	冷房	暖房
1030	103.0	113.6	30.25	31.29
1031	103.1	113.7	30.29	31.32
1032	103.2	113.8	30.32	31.35
1033	103.3	113.9	30.36	31.37
1034	103.4	114.1	30.40	31.40
1035	103.5	114.2	30.44	31.43
1036	103.6	114.3	30.47	31.45
1037	103.7	114.4	30.51	31.48
1038	103.8	114.5	30.55	31.51
1039	103.9	114.6	30.58	31.53
1040	104.0	114.7	30.62	31.56
1041	104.1	114.8	30.66	31.59
1042	104.2	114.9	30.69	31.61
1043	104.3	115.0	30.73	31.64
1044	104.4	115.2	30.77	31.67
1045	104.5	115.3	30.81	31.70
1046	104.6	115.4	30.84	31.72
1047	104.7	115.5	30.88	31.75
1048	104.8	115.6	30.92	31.78
1049	104.9	115.7	30.96	31.80
1050	105.0	115.8	30.99	31.83
1051	105.1	115.9	31.03	31.86
1052	105.2	116.0	31.07	31.88
1053	105.3	116.1	31.11	31.91
1054	105.4	116.3	31.14	31.94
1055	105.5	116.4	31.18	31.96
1056	105.6	116.5	31.22	31.99
1057	105.7	116.6	31.26	32.02
1058	105.8	116.7	31.29	32.04
1059	105.9	116.8	31.33	32.07
1060	106.0	116.9	31.37	32.10
1061	106.1	117.0	31.41	32.12
1062	106.2	117.1	31.44	32.15
1063	106.3	117.2	31.48	32.18
1064	106.4	117.4	31.52	32.20
1065	106.5	117.5	31.56	32.23
1066	106.6	117.6	31.60	32.26
1067	106.7	117.7	31.63	32.28
1068	106.8	117.8	31.67	32.31
1069	106.9	117.9	31.71	32.34
1070	107.0	118.0	31.75	32.36
1071	107.1	118.1	31.79	32.39
1072	107.2	118.2	31.83	32.42
1073	107.3	118.4	31.86	32.44
1074	107.4	118.5	31.90	32.47
1075	107.5	118.6	31.94	32.50
1076	107.6	118.7	31.98	32.52
1077	107.7	118.8	32.02	32.55
1078	107.8	118.9	32.06	32.58
1079	107.9	119.0	32.09	32.60
1080	108.0	119.1	32.13	32.63
1081	108.1	119.2	32.17	32.66
1082	108.2	119.3	32.21	32.68
1083	108.3	119.5	32.25	32.71
1084	108.4	119.6	32.29	32.74
1085	108.5	119.7	32.33	32.76
1086	108.6	119.8	32.37	32.79
1087	108.7	119.9	32.40	32.82
1088	108.8	120.0	32.44	32.84
1089	108.9	120.1	32.48	32.87
1090	109.0	120.2	32.52	32.90
1091	109.1	120.3	32.56	32.92
1092	109.2	120.4	32.60	32.95
1093	109.3	120.6	32.64	32.97
1094	109.4	120.7	32.68	33.00
1095	109.5	120.8	32.72	33.03
1096	109.6	120.9	32.75	33.05
1097	109.7	121.0	32.79	33.08
1098	109.8	121.1	32.83	33.11
1099	109.9	121.2	32.87	33.13

## 【PUHY-P1360SKM-E】

室内ユニット 合計容量	能力 (kW)		入力 (kW)	
	冷房	暖房	冷房	暖房
1100	110.0	121.3	32.91	33.16
1101	110.1	121.4	32.95	33.19
1102	110.2	121.6	32.99	33.21
1103	110.3	121.7	33.03	33.24
1104	110.4	121.8	33.07	33.27
1105	110.5	121.9	33.11	33.29
1106	110.6	122.0	33.15	33.32
1107	110.7	122.1	33.19	33.34
1108	110.8	122.2	33.23	33.37
1109	110.9	122.3	33.27	33.40
1110	111.0	122.4	33.31	33.42
1111	111.1	122.5	33.35	33.45
1112	111.2	122.7	33.39	33.48
1113	111.3	122.8	33.43	33.50
1114	111.4	122.9	33.47	33.53
1115	111.5	123.0	33.51	33.55
1116	111.6	123.1	33.55	33.58
1117	111.7	123.2	33.59	33.61
1118	111.8	123.3	33.63	33.63
1119	111.9	123.4	33.67	33.66
1120	112.0	123.5	33.71	33.69
1121	112.1	123.6	33.75	33.71
1122	112.2	123.8	33.79	33.74
1123	112.3	123.9	33.83	33.76
1124	112.4	124.0	33.87	33.79
1125	112.5	124.1	33.91	33.82
1126	112.6	124.2	33.95	33.84
1127	112.7	124.3	33.99	33.87
1128	112.8	124.4	34.03	33.90
1129	112.9	124.5	34.07	33.92
1130	113.0	124.6	34.11	33.95
1131	113.1	124.7	34.15	33.97
1132	113.2	124.9	34.19	34.00
1133	113.3	125.0	34.23	34.03
1134	113.4	125.1	34.27	34.05
1135	113.5	125.2	34.31	34.08
1136	113.6	125.3	34.35	34.10
1137	113.7	125.4	34.39	34.13
1138	113.8	125.5	34.43	34.16
1139	113.9	125.6	34.47	34.18
1140	114.0	125.7	34.51	34.21
1141	114.1	125.9	34.55	34.23
1142	114.2	126.0	34.60	34.26
1143	114.3	126.1	34.64	34.29
1144	114.4	126.2	34.68	34.31
1145	114.5	126.3	34.72	34.34
1146	114.6	126.4	34.76	34.36
1147	114.7	126.5	34.80	34.39
1148	114.8	126.6	34.84	34.42
1149	114.9	126.7	34.88	34.44
1150	115.0	126.8	34.92	34.47
1151	115.1	127.0	34.97	34.49
1152	115.2	127.1	35.01	34.52
1153	115.3	127.2	35.05	34.55
1154	115.4	127.3	35.09	34.57
1155	115.5	127.4	35.13	34.60
1156	115.6	127.5	35.17	34.62
1157	115.7	127.6	35.21	34.65
1158	115.8	127.7	35.25	34.68
1159	115.9	127.8	35.30	34.70
1160	116.0	127.9	35.34	34.73
1161	116.1	128.1	35.38	34.75
1162	116.2	128.2	35.42	34.78
1163	116.3	128.3	35.46	34.80
1164	116.4	128.4	35.50	34.83
1165	116.5	128.5	35.55	34.86
1166	116.6	128.6	35.59	34.88
1167	116.7	128.7	35.63	34.91
1168	116.8	128.8	35.67	34.93
1169	116.9	128.9	35.71	34.96

室内ユニット 合計容量	能力 (kW)		入力 (kW)	
	冷房	暖房	冷房	暖房
1170	117.0	129.1	35.75	34.99
1171	117.1	129.2	35.80	35.01
1172	117.2	129.3	35.84	35.04
1173	117.3	129.4	35.88	35.06
1174	117.4	129.5	35.92	35.09
1175	117.5	129.6	35.96	35.11
1176	117.6	129.7	36.01	35.14
1177	117.7	129.8	36.05	35.17
1178	117.8	129.9	36.09	35.19
1179	117.9	130.0	36.13	35.22
1180	118.0	130.2	36.18	35.24
1181	118.1	130.3	36.22	35.27
1182	118.2	130.4	36.26	35.29
1183	118.3	130.5	36.30	35.32
1184	118.4	130.6	36.35	35.35
1185	118.5	130.7	36.39	35.37
1186	118.6	130.8	36.43	35.40
1187	118.7	130.9	36.47	35.42
1188	118.8	131.0	36.52	35.45
1189	118.9	131.1	36.56	35.47
1190	119.0	131.3	36.60	35.50
1191	119.1	131.4	36.64	35.52
1192	119.2	131.5	36.69	35.55
1193	119.3	131.6	36.73	35.58
1194	119.4	131.7	36.77	35.60
1195	119.5	131.8	36.81	35.63
1196	119.6	131.9	36.86	35.65
1197	119.7	132.0	36.90	35.68
1198	119.8	132.1	36.94	35.70
1199	119.9	132.2	36.99	35.73
1200	120.0	132.4	37.03	35.75
1201	120.1	132.5	37.07	35.78
1202	120.2	132.6	37.12	35.81
1203	120.3	132.7	37.16	35.83
1204	120.4	132.8	37.20	35.86
1205	120.5	132.9	37.24	35.88
1206	120.6	133.0	37.29	35.91
1207	120.7	133.1	37.33	35.93
1208	120.8	133.2	37.37	35.96
1209	120.9	133.4	37.42	35.98
1210	121.0	133.5	37.46	36.01
1211	121.1	133.6	37.50	36.03
1212	121.2	133.7	37.55	36.06
1213	121.3	133.8	37.59	36.09
1214	121.4	133.9	37.64	36.11
1215	121.5	134.0	37.68	36.14
1216	121.6	134.1	37.72	36.16
1217	121.7	134.2	37.77	36.19
1218	121.8	134.3	37.81	36.21
1219	121.9	134.5	37.85	36.24
1220	122.0	134.6	37.90	36.26
1221	122.1	134.7	37.94	36.29
1222	122.2	134.8	37.98	36.31
1223	122.3	134.9	38.03	36.34
1224	122.4	135.0	38.07	36.36
1225	122.5	135.1	38.12	36.39
1226	122.6	135.2	38.16	36.42
1227	122.7	135.3	38.20	36.44
1228	122.8	135.4	38.25	36.47
1229	122.9	135.6	38.29	36.49
1230	123.0	135.7	38.34	36.52
1231	123.1	135.8	38.38	36.54
1232	123.2	135.9	38.43	36.57
1233	123.3	136.0	38.47	36.59
1234	123.4	136.1	38.51	36.62
1235	123.5	136.2	38.56	36.64
1236	123.6	136.3	38.60	36.67
1237	123.7	136.4	38.65	36.69
1238	123.8	136.6	38.69	36.72
1239	123.9	136.7	38.74	36.74

室内ユニット 合計容量	能力 (kW)		入力 (kW)	
	冷房	暖房	冷房	暖房
1240	124.0	136.8	38.78	36.77
1241	124.1	136.9	38.82	36.79
1242	124.2	137.0	38.87	36.82
1243	124.3	137.1	38.91	36.84
1244	124.4	137.2	38.96	36.87
1245	124.5	137.3	39.00	36.89
1246	124.6	137.4	39.05	36.92
1247	124.7	137.5	39.09	36.94
1248	124.8	137.7	39.14	36.97
1249	124.9	137.8	39.18	36.99
1250	125.0	137.9	39.23	37.02
1251	125.1	138.0	39.27	37.04
1252	125.2	138.1	39.32	37.07
1253	125.3	138.2	39.36	37.09
1254	125.4	138.3	39.41	37.12
1255	125.5	138.4	39.45	37.14
1256	125.6	138.5	39.50	37.17
1257	125.7	138.6	39.54	37.19
1258	125.8	138.8	39.59	37.22
1259	125.9	138.9	39.63	37.24
1260	126.0	139.0	39.68	37.27
1261	126.1	139.1	39.72	37.29
1262	126.2	139.2	39.77	37.32
1263	126.3	139.3	39.81	37.34
1264	126.4	139.4	39.86	37.37
1265	126.5	139.5	39.91	37.39
1266	126.6	139.6	39.95	37.42
1267	126.7	139.8	40.00	37.44
1268	126.8	139.9	40.04	37.47
1269	126.9	140.0	40.09	37.49
1270	127.0	140.1	40.13	37.52
1271	127.1	140.2	40.18	37.54
1272	127.2	140.3	40.22	37.57
1273	127.3	140.4	40.27	37.59
1274	127.4	140.5	40.32	37.62
1275	127.5	140.6	40.36	37.64
1276	127.6	140.7	40.41	37.67
1277	127.7	140.9	40.45	37.69
1278	127.8	141.0	40.50	37.72
1279	127.9	141.1	40.55	37.74
1280	128.0	141.2	40.59	37.77
1281	128.1	141.3	40.64	37.79
1282	128.2	141.4	40.68	37.82
1283	128.3	141.5	40.73	37.84
1284	128.4	141.6	40.78	37.87
1285	128.5	141.7	40.82	37.89
1286	128.6	141.8	40.87	37.92
1287	128.7	142.0	40.91	37.94
1288	128.8	142.1	40.96	37.97
1289	128.9	142.2	41.01	37.99
1290	129.0	142.3	41.05	38.02
1291	129.1	142.4	41.10	38.04
1292	129.2	142.5	41.15	38.07
1293	129.3	142.6	41.19	38.09
1294	129.4	142.7	41.24	38.11
1295	129.5	142.8	41.29	38.14
1296	129.6	142.9	41.33	38.16
1297	129.7	143.1	41.38	38.19
1298	129.8	143.2	41.43	38.21
1299	129.9	143.3	41.47	38.24
1300	130.0	143.4	41.52	38.26
1301	130.1	143.5	41.57	38.29
1302	130.2	143.6	41.61	38.31
1303	130.3	143.7	41.66	38.34
1304	130.4	143.8	41.71	38.36
1305	130.5	143.9	41.75	38.39
1306	130.6	144.1	41.80	38.41
1307	130.7	144.2	41.85	38.43
1308	130.8	144.3	41.89	38.46
1309	130.9	144.4	41.94	38.48

【PUHY-P1360SKM-E】

室内ユニット 合計容量	能力 (kW)		入力 (kW)	
	冷房	暖房	冷房	暖房
1310	131.0	144.5	41.99	38.51
1311	131.1	144.6	42.04	38.53
1312	131.2	144.7	42.08	38.56
1313	131.3	144.8	42.13	38.58
1314	131.4	144.9	42.18	38.61
1315	131.5	145.0	42.22	38.63
1316	131.6	145.2	42.27	38.66
1317	131.7	145.3	42.32	38.68
1318	131.8	145.4	42.37	38.70
1319	131.9	145.5	42.41	38.73
1320	132.0	145.6	42.46	38.75
1321	132.1	145.7	42.51	38.78
1322	132.2	145.8	42.56	38.80
1323	132.3	145.9	42.60	38.83
1324	132.4	146.0	42.65	38.85
1325	132.5	146.1	42.70	38.88
1326	132.6	146.3	42.75	38.90
1327	132.7	146.4	42.79	38.92
1328	132.8	146.5	42.84	38.95
1329	132.9	146.6	42.89	38.97
1330	133.0	146.7	42.94	39.00
1331	133.1	146.8	42.99	39.02
1332	133.2	146.9	43.03	39.05
1333	133.3	147.0	43.08	39.07
1334	133.4	147.1	43.13	39.10
1335	133.5	147.3	43.18	39.12
1336	133.6	147.4	43.23	39.14
1337	133.7	147.5	43.27	39.17
1338	133.8	147.6	43.32	39.19
1339	133.9	147.7	43.37	39.22
1340	134.0	147.8	43.42	39.24
1341	134.1	147.9	43.47	39.27
1342	134.2	148.0	43.52	39.29
1343	134.3	148.1	43.56	39.31
1344	134.4	148.2	43.61	39.34
1345	134.5	148.4	43.66	39.36
1346	134.6	148.5	43.71	39.39
1347	134.7	148.6	43.76	39.41
1348	134.8	148.7	43.81	39.44
1349	134.9	148.8	43.85	39.46
1350	135.0	148.9	43.90	39.48
1351	135.1	149.0	43.95	39.51
1352	135.2	149.1	44.00	39.53
1353	135.3	149.2	44.05	39.56
1354	135.4	149.3	44.10	39.58
1355	135.5	149.5	44.15	39.60
1356	135.6	149.6	44.20	39.63
1357	135.7	149.7	44.24	39.65
1358	135.8	149.8	44.29	39.68
1359	135.9	149.9	44.34	39.70
1360	136.0	150.0	44.40	39.73
1361	136.0	150.0	44.40	39.72
1362	136.0	150.0	44.40	39.72
1363	136.1	150.0	44.41	39.71
1364	136.1	150.0	44.41	39.71
1365	136.1	150.0	44.42	39.70
1366	136.1	150.0	44.42	39.70
1367	136.2	150.1	44.42	39.69
1368	136.2	150.1	44.43	39.69
1369	136.2	150.1	44.43	39.68
1370	136.2	150.1	44.43	39.68
1371	136.3	150.1	44.44	39.67
1372	136.3	150.1	44.44	39.67
1373	136.3	150.1	44.44	39.66
1374	136.3	150.1	44.45	39.66
1375	136.4	150.1	44.45	39.65
1376	136.4	150.1	44.46	39.65
1377	136.4	150.2	44.46	39.64
1378	136.4	150.2	44.46	39.63
1379	136.5	150.2	44.47	39.63

室内ユニット 合計容量	能力 (kW)		入力 (kW)	
	冷房	暖房	冷房	暖房
1380	136.5	150.2	44.47	39.62
1381	136.5	150.2	44.47	39.62
1382	136.5	150.2	44.48	39.61
1383	136.6	150.2	44.48	39.61
1384	136.6	150.2	44.48	39.60
1385	136.6	150.2	44.49	39.60
1386	136.6	150.2	44.49	39.59
1387	136.7	150.3	44.50	39.59
1388	136.7	150.3	44.50	39.58
1389	136.7	150.3	44.50	39.58
1390	136.7	150.3	44.51	39.57
1391	136.8	150.3	44.51	39.57
1392	136.8	150.3	44.51	39.56
1393	136.8	150.3	44.52	39.56
1394	136.8	150.3	44.52	39.55
1395	136.9	150.3	44.53	39.55
1396	136.9	150.3	44.53	39.54
1397	136.9	150.3	44.53	39.53
1398	136.9	150.4	44.54	39.53
1399	137.0	150.4	44.54	39.52
1400	137.0	150.4	44.54	39.52
1401	137.0	150.4	44.55	39.51
1402	137.0	150.4	44.55	39.51
1403	137.1	150.4	44.55	39.50
1404	137.1	150.4	44.56	39.50
1405	137.1	150.4	44.56	39.49
1406	137.1	150.4	44.57	39.49
1407	137.1	150.4	44.57	39.48
1408	137.2	150.5	44.57	39.48
1409	137.2	150.5	44.58	39.47
1410	137.2	150.5	44.58	39.47
1411	137.2	150.5	44.58	39.46
1412	137.3	150.5	44.59	39.46
1413	137.3	150.5	44.59	39.45
1414	137.3	150.5	44.59	39.45
1415	137.3	150.5	44.60	39.44
1416	137.4	150.5	44.60	39.43
1417	137.4	150.5	44.61	39.43
1418	137.4	150.6	44.61	39.42
1419	137.4	150.6	44.61	39.42
1420	137.5	150.6	44.62	39.41
1421	137.5	150.6	44.62	39.41
1422	137.5	150.6	44.62	39.40
1423	137.5	150.6	44.63	39.40
1424	137.6	150.6	44.63	39.39
1425	137.6	150.6	44.63	39.39
1426	137.6	150.6	44.64	39.38
1427	137.6	150.6	44.64	39.38
1428	137.7	150.7	44.65	39.37
1429	137.7	150.7	44.65	39.37
1430	137.7	150.7	44.65	39.36
1431	137.7	150.7	44.66	39.36
1432	137.8	150.7	44.66	39.35
1433	137.8	150.7	44.66	39.35
1434	137.8	150.7	44.67	39.34
1435	137.8	150.7	44.67	39.33
1436	137.9	150.7	44.67	39.33
1437	137.9	150.7	44.68	39.32
1438	137.9	150.8	44.68	39.32
1439	137.9	150.8	44.69	39.31
1440	138.0	150.8	44.69	39.31
1441	138.0	150.8	44.69	39.30
1442	138.0	150.8	44.70	39.30
1443	138.0	150.8	44.70	39.29
1444	138.1	150.8	44.70	39.29
1445	138.1	150.8	44.71	39.28
1446	138.1	150.8	44.71	39.28
1447	138.1	150.8	44.71	39.27
1448	138.2	150.9	44.72	39.27
1449	138.2	150.9	44.72	39.26

室内ユニット 合計容量	能力 (kW)		入力 (kW)	
	冷房	暖房	冷房	暖房
1450	138.2	150.9	44.73	39.26
1451	138.2	150.9	44.73	39.25
1452	138.3	150.9	44.73	39.25
1453	138.3	150.9	44.74	39.24
1454	138.3	150.9	44.74	39.23
1455	138.3	150.9	44.74	39.23
1456	138.4	150.9	44.75	39.22
1457	138.4	150.9	44.75	39.22
1458	138.4	150.9	44.75	39.21
1459	138.4	151.0	44.76	39.21
1460	138.5	151.0	44.76	39.20
1461	138.5	151.0	44.77	39.20
1462	138.5	151.0	44.77	39.19
1463	138.5	151.0	44.77	39.19
1464	138.6	151.0	44.78	39.18
1465	138.6	151.0	44.78	39.18
1466	138.6	151.0	44.78	39.17
1467	138.6	151.0	44.79	39.17
1468	138.7	151.0	44.79	39.16
1469	138.7	151.1	44.79	39.16
1470	138.7	151.1	44.80	39.15
1471	138.7	151.1	44.80	39.15
1472	138.8	151.1	44.81	39.14
1473	138.8	151.1	44.81	39.13
1474	138.8	151.1	44.81	39.13
1475	138.8	151.1	44.82	39.12
1476	138.9	151.1	44.82	39.12
1477	138.9	151.1	44.82	39.11
1478	138.9	151.1	44.83	39.11
1479	138.9	151.2	44.83	39.10
1480	139.0	151.2	44.83	39.10
1481	139.0	151.2	44.84	39.09
1482	139.0	151.2	44.84	39.09
1483	139.0	151.2	44.85	39.08
1484	139.1	151.2	44.85	39.08
1485	139.1	151.2	44.85	39.07
1486	139.1	151.2	44.86	39.07
1487	139.1	151.2	44.86	39.06
1488	139.2	151.2	44.86	39.06
1489	139.2	151.3	44.87	39.05
1490	139.2	151.3	44.87	39.05
1491	139.2	151.3	44.87	39.04
1492	139.3	151.3	44.88	39.03
1493	139.3	151.3	44.88	39.03
1494	139.3	151.3	44.89	39.02
1495	139.3	151.3	44.89	39.02
1496	139.4	151.3	44.89	39.01
1497	139.4	151.3	44.90	39.01
1498	139.4	151.3	44.90	39.00
1499	139.4	151.4	44.90	39.00
1500	139.5	151.4	44.91	38.99
1501	139.5	151.4	44.91	38.99
1502	139.5	151.4	44.91	38.98
1503	139.5	151.4	44.92	38.98
1504	139.6	151.4	44.92	38.97
1505	139.6	151.4	44.93	38.97
1506	139.6	151.4	44.93	38.96
1507	139.6	151.4	44.93	38.96
1508	139.7	151.4	44.94	38.95
1509	139.7	151.5	44.94	38.95
1510	139.7	151.5	44.94	38.94
1511	139.7	151.5	44.95	38.93
1512	139.8	151.5	44.95	38.93
1513	139.8	151.5	44.95	38.92
1514	139.8	151.5	44.96	38.92
1515	139.8	151.5	44.96	38.91
1516	139.9	151.5	44.97	38.91
1517	139.9	151.5	44.97	38.90
1518	139.9	151.5	44.97	38.90
1519	139.9	151.5	44.98	38.89

【PUHY-P1360SKM-E】

室内ユニット 合計容量	能力 (kW)		入力 (kW)	
	冷房	暖房	冷房	暖房
1520	140.0	151.6	44.98	38.89
1521	140.0	151.6	44.98	38.88
1522	140.0	151.6	44.99	38.88
1523	140.0	151.6	44.99	38.87
1524	140.1	151.6	44.99	38.87
1525	140.1	151.6	45.00	38.86
1526	140.1	151.6	45.00	38.86
1527	140.1	151.6	45.01	38.85
1528	140.2	151.6	45.01	38.85
1529	140.2	151.6	45.01	38.84
1530	140.2	151.7	45.02	38.83
1531	140.2	151.7	45.02	38.83
1532	140.3	151.7	45.02	38.82
1533	140.3	151.7	45.03	38.82
1534	140.3	151.7	45.03	38.81
1535	140.3	151.7	45.03	38.81
1536	140.4	151.7	45.04	38.80
1537	140.4	151.7	45.04	38.80
1538	140.4	151.7	45.05	38.79
1539	140.4	151.7	45.05	38.79
1540	140.5	151.8	45.05	38.78
1541	140.5	151.8	45.06	38.78
1542	140.5	151.8	45.06	38.77
1543	140.5	151.8	45.06	38.77
1544	140.6	151.8	45.07	38.76
1545	140.6	151.8	45.07	38.76
1546	140.6	151.8	45.07	38.75
1547	140.6	151.8	45.08	38.75
1548	140.7	151.8	45.08	38.74
1549	140.7	151.8	45.09	38.73
1550	140.7	151.9	45.09	38.73
1551	140.7	151.9	45.09	38.72
1552	140.8	151.9	45.10	38.72
1553	140.8	151.9	45.10	38.71
1554	140.8	151.9	45.10	38.71
1555	140.8	151.9	45.11	38.70
1556	140.9	151.9	45.11	38.70
1557	140.9	151.9	45.11	38.69
1558	140.9	151.9	45.12	38.69
1559	140.9	151.9	45.12	38.68
1560	141.0	152.0	45.13	38.68
1561	141.0	152.0	45.13	38.67
1562	141.0	152.0	45.13	38.67
1563	141.0	152.0	45.14	38.66
1564	141.0	152.0	45.14	38.66
1565	141.1	152.0	45.14	38.65
1566	141.1	152.0	45.15	38.65
1567	141.1	152.0	45.15	38.64
1568	141.1	152.0	45.15	38.63
1569	141.2	152.0	45.16	38.63
1570	141.2	152.1	45.16	38.62
1571	141.2	152.1	45.17	38.62
1572	141.2	152.1	45.17	38.61
1573	141.3	152.1	45.17	38.61
1574	141.3	152.1	45.18	38.60
1575	141.3	152.1	45.18	38.60
1576	141.3	152.1	45.18	38.59
1577	141.4	152.1	45.19	38.59
1578	141.4	152.1	45.19	38.58
1579	141.4	152.1	45.19	38.58
1580	141.4	152.2	45.20	38.57
1581	141.5	152.2	45.20	38.57
1582	141.5	152.2	45.21	38.56
1583	141.5	152.2	45.21	38.56
1584	141.5	152.2	45.21	38.55
1585	141.6	152.2	45.22	38.54
1586	141.6	152.2	45.22	38.54
1587	141.6	152.2	45.22	38.53
1588	141.6	152.2	45.23	38.53
1589	141.7	152.2	45.23	38.52

室内ユニット 合計容量	能力 (kW)		入力 (kW)	
	冷房	暖房	冷房	暖房
1590	141.7	152.2	45.23	38.52
1591	141.7	152.3	45.24	38.51
1592	141.7	152.3	45.24	38.51
1593	141.8	152.3	45.25	38.50
1594	141.8	152.3	45.25	38.50
1595	141.8	152.3	45.25	38.49
1596	141.8	152.3	45.26	38.49
1597	141.9	152.3	45.26	38.48
1598	141.9	152.3	45.26	38.48
1599	141.9	152.3	45.27	38.47
1600	141.9	152.3	45.27	38.47
1601	142.0	152.4	45.27	38.46
1602	142.0	152.4	45.28	38.46
1603	142.0	152.4	45.28	38.45
1604	142.0	152.4	45.29	38.44
1605	142.1	152.4	45.29	38.44
1606	142.1	152.4	45.29	38.43
1607	142.1	152.4	45.30	38.43
1608	142.1	152.4	45.30	38.42
1609	142.2	152.4	45.30	38.42
1610	142.2	152.4	45.31	38.41
1611	142.2	152.5	45.31	38.41
1612	142.2	152.5	45.31	38.40
1613	142.3	152.5	45.32	38.40
1614	142.3	152.5	45.32	38.39
1615	142.3	152.5	45.33	38.39
1616	142.3	152.5	45.33	38.38
1617	142.4	152.5	45.33	38.38
1618	142.4	152.5	45.34	38.37
1619	142.4	152.5	45.34	38.37
1620	142.4	152.5	45.34	38.36
1621	142.5	152.6	45.35	38.36
1622	142.5	152.6	45.35	38.35
1623	142.5	152.6	45.35	38.34
1624	142.5	152.6	45.36	38.34
1625	142.6	152.6	45.36	38.33
1626	142.6	152.6	45.37	38.33
1627	142.6	152.6	45.37	38.32
1628	142.6	152.6	45.37	38.32
1629	142.7	152.6	45.38	38.31
1630	142.7	152.6	45.38	38.31
1631	142.7	152.7	45.38	38.30
1632	142.7	152.7	45.39	38.30
1633	142.8	152.7	45.39	38.29
1634	142.8	152.7	45.39	38.29
1635	142.8	152.7	45.40	38.28
1636	142.8	152.7	45.40	38.28
1637	142.9	152.7	45.41	38.27
1638	142.9	152.7	45.41	38.27
1639	142.9	152.7	45.41	38.26
1640	142.9	152.7	45.42	38.26
1641	143.0	152.8	45.42	38.25
1642	143.0	152.8	45.42	38.24
1643	143.0	152.8	45.43	38.24
1644	143.0	152.8	45.43	38.23
1645	143.1	152.8	45.43	38.23
1646	143.1	152.8	45.44	38.22
1647	143.1	152.8	45.44	38.22
1648	143.1	152.8	45.45	38.21
1649	143.2	152.8	45.45	38.21
1650	143.2	152.8	45.45	38.20
1651	143.2	152.8	45.46	38.20
1652	143.2	152.9	45.46	38.19
1653	143.3	152.9	45.46	38.19
1654	143.3	152.9	45.47	38.18
1655	143.3	152.9	45.47	38.18
1656	143.3	152.9	45.47	38.17
1657	143.4	152.9	45.48	38.17
1658	143.4	152.9	45.48	38.16
1659	143.4	152.9	45.49	38.16

室内ユニット 合計容量	能力 (kW)		入力 (kW)	
	冷房	暖房	冷房	暖房
1660	143.4	152.9	45.49	38.15
1661	143.5	152.9	45.49	38.14
1662	143.5	153.0	45.50	38.14
1663	143.5	153.0	45.50	38.13
1664	143.5	153.0	45.50	38.13
1665	143.6	153.0	45.51	38.12
1666	143.6	153.0	45.51	38.12
1667	143.6	153.0	45.51	38.11
1668	143.6	153.0	45.52	38.11
1669	143.7	153.0	45.52	38.10
1670	143.7	153.0	45.53	38.10
1671	143.7	153.0	45.53	38.09
1672	143.7	153.1	45.53	38.09
1673	143.8	153.1	45.54	38.08
1674	143.8	153.1	45.54	38.08
1675	143.8	153.1	45.54	38.07
1676	143.8	153.1	45.55	38.07
1677	143.9	153.1	45.55	38.06
1678	143.9	153.1	45.55	38.06
1679	143.9	153.1	45.56	38.05
1680	143.9	153.1	45.56	38.04
1681	144.0	153.1	45.57	38.04
1682	144.0	153.2	45.57	38.03
1683	144.0	153.2	45.57	38.03
1684	144.0	153.2	45.58	38.02
1685	144.1	153.2	45.58	38.02
1686	144.1	153.2	45.58	38.01
1687	144.1	153.2	45.59	38.01
1688	144.1	153.2	45.59	38.00
1689	144.2	153.2	45.59	38.00
1690	144.2	153.2	45.60	37.99
1691	144.2	153.2	45.60	37.99
1692	144.2	153.3	45.61	37.98
1693	144.3	153.3	45.61	37.98
1694	144.3	153.3	45.61	37.97
1695	144.3	153.3	45.62	37.97
1696	144.3	153.3	45.62	37.96
1697	144.4	153.3	45.62	37.96
1698	144.4	153.3	45.63	37.95
1699	144.4	153.3	45.63	37.94
1700	144.4	153.3	45.63	37.94
1701	144.5	153.3	45.64	37.93
1702	144.5	153.4	45.64	37.93
1703	144.5	153.4	45.65	37.92
1704	144.5	153.4	45.65	37.92
1705	144.6	153.4	45.65	37.91
1706	144.6	153.4	45.66	37.91
1707	144.6	153.4	45.66	37.90
1708	144.6	153.4	45.66	37.90
1709	144.7	153.4	45.67	37.89
1710	144.7	153.4	45.67	37.89
1711	144.7	153.4	45.67	37.88
1712	144.7	153.4	45.68	37.88
1713	144.8	153.5	45.68	37.87
1714	144.8	153.5	45.69	37.87
1715	144.8	153.5	45.69	37.86
1716	144.8	153.5	45.69	37.86
1717	144.9	153.5	45.70	37.85
1718	144.9	153.5	45.70	37.84
1719	144.9	153.5	45.70	37.84
1720	144.9	153.5	45.71	37.83
1721	144.9	153.5	45.71	37.83
1722	145.0	153.5	45.71	37.82
1723	145.0	153.6	45.72	37.82
1724	145.0	153.6	45.72	37.81
1725	145.0	153.6	45.73	37.81
1726	145.1	153.6	45.73	37.80
1727	145.1	153.6	45.73	37.80
1728	145.1	153.6	45.74	37.79
1729	145.1	153.6	45.74	37.79

### 【PUHY-P1360SKM-E】

室内ユニット 合計容量	能力 (kW)		入力 (kW)	
	冷房	暖房	冷房	暖房
1730	145.2	153.6	45.74	37.78
1731	145.2	153.6	45.75	37.78
1732	145.2	153.6	45.75	37.77
1733	145.2	153.7	45.75	37.77
1734	145.3	153.7	45.76	37.76
1735	145.3	153.7	45.76	37.76
1736	145.3	153.7	45.77	37.75
1737	145.3	153.7	45.77	37.74
1738	145.4	153.7	45.77	37.74
1739	145.4	153.7	45.78	37.73
1740	145.4	153.7	45.78	37.73
1741	145.4	153.7	45.78	37.72
1742	145.5	153.7	45.79	37.72
1743	145.5	153.8	45.79	37.71
1744	145.5	153.8	45.79	37.71
1745	145.5	153.8	45.80	37.70
1746	145.6	153.8	45.80	37.70
1747	145.6	153.8	45.81	37.69
1748	145.6	153.8	45.81	37.69
1749	145.6	153.8	45.81	37.68
1750	145.7	153.8	45.82	37.68
1751	145.7	153.8	45.82	37.67
1752	145.7	153.8	45.82	37.67
1753	145.7	153.9	45.83	37.66
1754	145.8	153.9	45.83	37.66
1755	145.8	153.9	45.83	37.65
1756	145.8	153.9	45.84	37.64
1757	145.8	153.9	45.84	37.64
1758	145.9	153.9	45.85	37.63
1759	145.9	153.9	45.85	37.63
1760	145.9	153.9	45.85	37.62
1761	145.9	153.9	45.86	37.62
1762	146.0	153.9	45.86	37.61
1763	146.0	154.0	45.86	37.61
1764	146.0	154.0	45.87	37.60
1765	146.0	154.0	45.87	37.60
1766	146.1	154.0	45.87	37.59
1767	146.1	154.0	45.88	37.59
1768	146.1	154.0	45.88	37.58



【PUHY-P1400SKM-E】

室内ユニット 合計容量	能力 (kW)		入力 (kW)	
	冷房	暖房	冷房	暖房
700	70.0	78.3	21.40	22.28
701	70.1	78.4	21.43	22.31
702	70.2	78.5	21.46	22.34
703	70.3	78.6	21.49	22.37
704	70.4	78.7	21.52	22.40
705	70.5	78.8	21.55	22.43
706	70.6	79.0	21.58	22.46
707	70.7	79.1	21.61	22.49
708	70.8	79.2	21.64	22.52
709	70.9	79.3	21.67	22.55
710	71.0	79.4	21.70	22.58
711	71.1	79.5	21.73	22.61
712	71.2	79.6	21.76	22.64
713	71.3	79.7	21.79	22.66
714	71.4	79.9	21.82	22.69
715	71.5	80.0	21.85	22.72
716	71.6	80.1	21.88	22.75
717	71.7	80.2	21.91	22.78
718	71.8	80.3	21.93	22.81
719	71.9	80.4	21.96	22.84
720	72.0	80.5	21.99	22.87
721	72.1	80.6	22.02	22.90
722	72.2	80.7	22.05	22.93
723	72.3	80.9	22.08	22.96
724	72.4	81.0	22.11	22.99
725	72.5	81.1	22.14	23.02
726	72.6	81.2	22.17	23.05
727	72.7	81.3	22.20	23.08
728	72.8	81.4	22.23	23.11
729	72.9	81.5	22.26	23.14
730	73.0	81.6	22.29	23.16
731	73.1	81.8	22.32	23.19
732	73.2	81.9	22.35	23.22
733	73.3	82.0	22.38	23.25
734	73.4	82.1	22.41	23.28
735	73.5	82.2	22.44	23.31
736	73.6	82.3	22.48	23.34
737	73.7	82.4	22.51	23.37
738	73.8	82.5	22.54	23.40
739	73.9	82.6	22.57	23.43
740	74.0	82.8	22.60	23.46
741	74.1	82.9	22.63	23.49
742	74.2	83.0	22.66	23.52
743	74.3	83.1	22.69	23.55
744	74.4	83.2	22.72	23.58
745	74.5	83.3	22.75	23.61
746	74.6	83.4	22.78	23.64
747	74.7	83.5	22.81	23.66
748	74.8	83.7	22.84	23.69
749	74.9	83.8	22.87	23.72
750	75.0	83.9	22.90	23.75
751	75.1	84.0	22.93	23.78
752	75.2	84.1	22.96	23.81
753	75.3	84.2	22.99	23.84
754	75.4	84.3	23.02	23.87
755	75.5	84.4	23.05	23.90
756	75.6	84.5	23.08	23.93
757	75.7	84.7	23.11	23.96
758	75.8	84.8	23.15	23.99
759	75.9	84.9	23.18	24.02
760	76.0	85.0	23.21	24.05
761	76.1	85.1	23.24	24.08
762	76.2	85.2	23.27	24.11
763	76.3	85.3	23.30	24.13
764	76.4	85.4	23.33	24.16
765	76.5	85.6	23.36	24.19
766	76.6	85.7	23.39	24.22
767	76.7	85.8	23.42	24.25
768	76.8	85.9	23.45	24.28
769	76.9	86.0	23.48	24.31

室内ユニット 合計容量	能力 (kW)		入力 (kW)	
	冷房	暖房	冷房	暖房
770	77.0	86.1	23.52	24.34
771	77.1	86.2	23.55	24.37
772	77.2	86.3	23.58	24.40
773	77.3	86.4	23.61	24.43
774	77.4	86.6	23.64	24.46
775	77.5	86.7	23.67	24.49
776	77.6	86.8	23.70	24.52
777	77.7	86.9	23.73	24.55
778	77.8	87.0	23.76	24.57
779	77.9	87.1	23.80	24.60
780	78.0	87.2	23.83	24.63
781	78.1	87.3	23.86	24.66
782	78.2	87.4	23.89	24.69
783	78.3	87.6	23.92	24.72
784	78.4	87.7	23.95	24.75
785	78.5	87.8	23.98	24.78
786	78.6	87.9	24.01	24.81
787	78.7	88.0	24.05	24.84
788	78.8	88.1	24.08	24.87
789	78.9	88.2	24.11	24.90
790	79.0	88.3	24.14	24.93
791	79.1	88.5	24.17	24.96
792	79.2	88.6	24.20	24.99
793	79.3	88.7	24.23	25.02
794	79.4	88.8	24.27	25.04
795	79.5	88.9	24.30	25.07
796	79.6	89.0	24.33	25.10
797	79.7	89.1	24.36	25.13
798	79.8	89.2	24.39	25.16
799	79.9	89.3	24.42	25.19
800	80.0	89.5	24.46	25.22
801	80.1	89.6	24.49	25.25
802	80.2	89.7	24.52	25.28
803	80.3	89.8	24.55	25.31
804	80.4	89.9	24.58	25.34
805	80.5	90.0	24.61	25.37
806	80.6	90.1	24.65	25.40
807	80.7	90.2	24.68	25.43
808	80.8	90.4	24.71	25.46
809	80.9	90.5	24.74	25.48
810	81.0	90.6	24.77	25.51
811	81.1	90.7	24.81	25.54
812	81.2	90.8	24.84	25.57
813	81.3	90.9	24.87	25.60
814	81.4	91.0	24.90	25.63
815	81.5	91.1	24.93	25.66
816	81.6	91.2	24.97	25.69
817	81.7	91.4	25.00	25.72
818	81.8	91.5	25.03	25.75
819	81.9	91.6	25.06	25.78
820	82.0	91.7	25.09	25.81
821	82.1	91.8	25.13	25.84
822	82.2	91.9	25.16	25.87
823	82.3	92.0	25.19	25.89
824	82.4	92.1	25.22	25.92
825	82.5	92.3	25.26	25.95
826	82.6	92.4	25.29	25.98
827	82.7	92.5	25.32	26.01
828	82.8	92.6	25.35	26.04
829	82.9	92.7	25.38	26.07
830	83.0	92.8	25.42	26.10
831	83.1	92.9	25.45	26.13
832	83.2	93.0	25.48	26.16
833	83.3	93.1	25.51	26.19
834	83.4	93.3	25.55	26.22
835	83.5	93.4	25.58	26.25
836	83.6	93.5	25.61	26.28
837	83.7	93.6	25.64	26.31
838	83.8	93.7	25.68	26.33
839	83.9	93.8	25.71	26.36

室内ユニット 合計容量	能力 (kW)		入力 (kW)	
	冷房	暖房	冷房	暖房
840	84.0	93.9	25.74	26.39
841	84.1	94.0	25.77	26.42
842	84.2	94.2	25.81	26.45
843	84.3	94.3	25.84	26.48
844	84.4	94.4	25.87	26.51
845	84.5	94.5	25.90	26.54
846	84.6	94.6	25.94	26.57
847	84.7	94.7	25.97	26.60
848	84.8	94.8	26.00	26.63
849	84.9	94.9	26.04	26.66
850	85.0	95.0	26.07	26.69
851	85.1	95.2	26.10	26.72
852	85.2	95.3	26.13	26.74
853	85.3	95.4	26.17	26.77
854	85.4	95.5	26.20	26.80
855	85.5	95.6	26.23	26.83
856	85.6	95.7	26.27	26.86
857	85.7	95.8	26.30	26.89
858	85.8	95.9	26.33	26.92
859	85.9	96.1	26.36	26.95
860	86.0	96.2	26.40	26.98
861	86.1	96.3	26.43	27.01
862	86.2	96.4	26.46	27.04
863	86.3	96.5	26.50	27.07
864	86.4	96.6	26.53	27.10
865	86.5	96.7	26.56	27.12
866	86.6	96.8	26.60	27.15
867	86.7	96.9	26.63	27.18
868	86.8	97.1	26.66	27.21
869	86.9	97.2	26.70	27.24
870	87.0	97.3	26.73	27.27
871	87.1	97.4	26.76	27.30
872	87.2	97.5	26.80	27.33
873	87.3	97.6	26.83	27.36
874	87.4	97.7	26.86	27.39
875	87.5	97.8	26.90	27.42
876	87.6	97.9	26.93	27.45
877	87.7	98.1	26.96	27.48
878	87.8	98.2	27.00	27.51
879	87.9	98.3	27.03	27.53
880	88.0	98.4	27.06	27.56
881	88.1	98.5	27.10	27.59
882	88.2	98.6	27.13	27.62
883	88.3	98.7	27.16	27.65
884	88.4	98.8	27.20	27.68
885	88.5	99.0	27.23	27.71
886	88.6	99.1	27.26	27.74
887	88.7	99.2	27.30	27.77
888	88.8	99.3	27.33	27.80
889	88.9	99.4	27.37	27.83
890	89.0	99.5	27.40	27.86
891	89.1	99.6	27.43	27.89
892	89.2	99.7	27.47	27.91
893	89.3	99.8	27.50	27.94
894	89.4	100.0	27.53	27.97
895	89.5	100.1	27.57	28.00
896	89.6	100.2	27.60	28.03
897	89.7	100.3	27.64	28.06
898	89.8	100.4	27.67	28.09
899	89.9	100.5	27.70	28.12
900	90.0	100.6	27.74	28.15
901	90.1	100.7	27.77	28.18
902	90.2	100.9	27.81	28.21
903	90.3	101.0	27.84	28.24
904	90.4	101.1	27.87	28.27
905	90.5	101.2	27.91	28.29
906	90.6	101.3	27.94	28.32
907	90.7	101.4	27.98	28.35
908	90.8	101.5	28.01	28.38
909	90.9	101.6	28.04	28.41

### 【PUHY-P1400SKM-E】

室内ユニット 合計容量	能力 (kW)		入力 (kW)	
	冷房	暖房	冷房	暖房
910	91.0	101.7	28.08	28.44
911	91.1	101.9	28.11	28.47
912	91.2	102.0	28.15	28.50
913	91.3	102.1	28.18	28.53
914	91.4	102.2	28.22	28.56
915	91.5	102.3	28.25	28.59
916	91.6	102.4	28.28	28.62
917	91.7	102.5	28.32	28.64
918	91.8	102.6	28.35	28.67
919	91.9	102.8	28.39	28.70
920	92.0	102.9	28.42	28.73
921	92.1	103.0	28.46	28.76
922	92.2	103.1	28.49	28.79
923	92.3	103.2	28.53	28.82
924	92.4	103.3	28.56	28.85
925	92.5	103.4	28.59	28.88
926	92.6	103.5	28.63	28.91
927	92.7	103.6	28.66	28.94
928	92.8	103.8	28.70	28.97
929	92.9	103.9	28.73	29.00
930	93.0	104.0	28.77	29.02
931	93.1	104.1	28.80	29.05
932	93.2	104.2	28.84	29.08
933	93.3	104.3	28.87	29.11
934	93.4	104.4	28.91	29.14
935	93.5	104.5	28.94	29.17
936	93.6	104.7	28.98	29.20
937	93.7	104.8	29.01	29.23
938	93.8	104.9	29.04	29.26
939	93.9	105.0	29.08	29.29
940	94.0	105.1	29.11	29.32
941	94.1	105.2	29.15	29.35
942	94.2	105.3	29.18	29.37
943	94.3	105.4	29.22	29.40
944	94.4	105.5	29.25	29.43
945	94.5	105.7	29.29	29.46
946	94.6	105.8	29.32	29.49
947	94.7	105.9	29.36	29.52
948	94.8	106.0	29.39	29.55
949	94.9	106.1	29.43	29.58
950	95.0	106.2	29.46	29.61
951	95.1	106.3	29.50	29.64
952	95.2	106.4	29.53	29.67
953	95.3	106.6	29.57	29.70
954	95.4	106.7	29.61	29.72
955	95.5	106.8	29.64	29.75
956	95.6	106.9	29.68	29.78
957	95.7	107.0	29.71	29.81
958	95.8	107.1	29.75	29.84
959	95.9	107.2	29.78	29.87
960	96.0	107.3	29.82	29.90
961	96.1	107.4	29.85	29.93
962	96.2	107.6	29.89	29.96
963	96.3	107.7	29.92	29.99
964	96.4	107.8	29.96	30.02
965	96.5	107.9	29.99	30.05
966	96.6	108.0	30.03	30.07
967	96.7	108.1	30.06	30.10
968	96.8	108.2	30.10	30.13
969	96.9	108.3	30.14	30.16
970	97.0	108.4	30.17	30.19
971	97.1	108.6	30.21	30.22
972	97.2	108.7	30.24	30.25
973	97.3	108.8	30.28	30.28
974	97.4	108.9	30.31	30.31
975	97.5	109.0	30.35	30.34
976	97.6	109.1	30.38	30.37
977	97.7	109.2	30.42	30.40
978	97.8	109.3	30.46	30.42
979	97.9	109.5	30.49	30.45

室内ユニット 合計容量	能力 (kW)		入力 (kW)	
	冷房	暖房	冷房	暖房
980	98.0	109.6	30.53	30.48
981	98.1	109.7	30.56	30.51
982	98.2	109.8	30.60	30.54
983	98.3	109.9	30.64	30.57
984	98.4	110.0	30.67	30.60
985	98.5	110.1	30.71	30.63
986	98.6	110.2	30.74	30.66
987	98.7	110.3	30.78	30.69
988	98.8	110.5	30.81	30.72
989	98.9	110.6	30.85	30.74
990	99.0	110.7	30.89	30.77
991	99.1	110.8	30.92	30.80
992	99.2	110.9	30.96	30.83
993	99.3	111.0	30.99	30.86
994	99.4	111.1	31.03	30.89
995	99.5	111.2	31.07	30.92
996	99.6	111.4	31.10	30.95
997	99.7	111.5	31.14	30.98
998	99.8	111.6	31.18	31.01
999	99.9	111.7	31.21	31.04
1000	100.0	111.8	31.25	31.07
1001	100.1	111.9	31.28	31.09
1002	100.2	112.0	31.32	31.12
1003	100.3	112.1	31.36	31.15
1004	100.4	112.2	31.39	31.18
1005	100.5	112.4	31.43	31.21
1006	100.6	112.5	31.47	31.24
1007	100.7	112.6	31.50	31.27
1008	100.8	112.7	31.54	31.30
1009	100.9	112.8	31.58	31.33
1010	101.0	112.9	31.61	31.36
1011	101.1	113.0	31.65	31.39
1012	101.2	113.1	31.68	31.41
1013	101.3	113.3	31.72	31.44
1014	101.4	113.4	31.76	31.47
1015	101.5	113.5	31.79	31.50
1016	101.6	113.6	31.83	31.53
1017	101.7	113.7	31.87	31.56
1018	101.8	113.8	31.90	31.59
1019	101.9	113.9	31.94	31.62
1020	102.0	114.0	31.98	31.65
1021	102.1	114.1	32.01	31.68
1022	102.2	114.3	32.05	31.71
1023	102.3	114.4	32.09	31.73
1024	102.4	114.5	32.12	31.76
1025	102.5	114.6	32.16	31.79
1026	102.6	114.7	32.20	31.82
1027	102.7	114.8	32.23	31.85
1028	102.8	114.9	32.27	31.88
1029	102.9	115.0	32.31	31.91
1030	103.0	115.2	32.35	31.94
1031	103.1	115.3	32.38	31.97
1032	103.2	115.4	32.42	32.00
1033	103.3	115.5	32.46	32.03
1034	103.4	115.6	32.49	32.05
1035	103.5	115.7	32.53	32.08
1036	103.6	115.8	32.57	32.11
1037	103.7	115.9	32.60	32.14
1038	103.8	116.0	32.64	32.17
1039	103.9	116.2	32.68	32.20
1040	104.0	116.3	32.72	32.23
1041	104.1	116.4	32.75	32.26
1042	104.2	116.5	32.79	32.29
1043	104.3	116.6	32.83	32.32
1044	104.4	116.7	32.86	32.35
1045	104.5	116.8	32.90	32.37
1046	104.6	116.9	32.94	32.40
1047	104.7	117.0	32.98	32.43
1048	104.8	117.2	33.01	32.46
1049	104.9	117.3	33.05	32.49

室内ユニット 合計容量	能力 (kW)		入力 (kW)	
	冷房	暖房	冷房	暖房
1050	105.0	117.4	33.09	32.52
1051	105.1	117.5	33.13	32.55
1052	105.2	117.6	33.16	32.58
1053	105.3	117.7	33.20	32.61
1054	105.4	117.8	33.24	32.64
1055	105.5	117.9	33.28	32.66
1056	105.6	118.1	33.31	32.69
1057	105.7	118.2	33.35	32.72
1058	105.8	118.3	33.39	32.75
1059	105.9	118.4	33.43	32.78
1060	106.0	118.5	33.46	32.81
1061	106.1	118.6	33.50	32.84
1062	106.2	118.7	33.54	32.87
1063	106.3	118.8	33.58	32.90
1064	106.4	118.9	33.61	32.93
1065	106.5	119.1	33.65	32.96
1066	106.6	119.2	33.69	32.98
1067	106.7	119.3	33.73	33.01
1068	106.8	119.4	33.77	33.04
1069	106.9	119.5	33.80	33.07
1070	107.0	119.6	33.84	33.10
1071	107.1	119.7	33.88	33.13
1072	107.2	119.8	33.92	33.16
1073	107.3	120.0	33.95	33.19
1074	107.4	120.1	33.99	33.22
1075	107.5	120.2	34.03	33.25
1076	107.6	120.3	34.07	33.27
1077	107.7	120.4	34.11	33.30
1078	107.8	120.5	34.14	33.33
1079	107.9	120.6	34.18	33.36
1080	108.0	120.7	34.22	33.39
1081	108.1	120.8	34.26	33.42
1082	108.2	121.0	34.30	33.45
1083	108.3	121.1	34.33	33.48
1084	108.4	121.2	34.37	33.51
1085	108.5	121.3	34.41	33.54
1086	108.6	121.4	34.45	33.56
1087	108.7	121.5	34.49	33.59
1088	108.8	121.6	34.53	33.62
1089	108.9	121.7	34.56	33.65
1090	109.0	121.9	34.60	33.68
1091	109.1	122.0	34.64	33.71
1092	109.2	122.1	34.68	33.74
1093	109.3	122.2	34.72	33.77
1094	109.4	122.3	34.76	33.80
1095	109.5	122.4	34.79	33.83
1096	109.6	122.5	34.83	33.86
1097	109.7	122.6	34.87	33.88
1098	109.8	122.7	34.91	33.91
1099	109.9	122.9	34.95	33.94
1100	110.0	123.0	34.99	33.97
1101	110.1	123.1	35.02	34.00
1102	110.2	123.2	35.06	34.03
1103	110.3	123.3	35.10	34.06
1104	110.4	123.4	35.14	34.09
1105	110.5	123.5	35.18	34.12
1106	110.6	123.6	35.22	34.15
1107	110.7	123.8	35.26	34.17
1108	110.8	123.9	35.29	34.20
1109	110.9	124.0	35.33	34.23
1110	111.0	124.1	35.37	34.26
1111	111.1	124.2	35.41	34.29
1112	111.2	124.3	35.45	34.32
1113	111.3	124.4	35.49	34.35
1114	111.4	124.5	35.53	34.38
1115	111.5	124.6	35.57	34.41
1116	111.6	124.8	35.61	34.44
1117	111.7	124.9	35.64	34.46
1118	111.8	125.0	35.68	34.49
1119	111.9	125.1	35.72	34.52

## 【PUHY-P1400SKM-E】

室内ユニット 合計容量	能力 (kW)		入力 (kW)	
	冷房	暖房	冷房	暖房
1120	112.0	125.2	35.76	34.55
1121	112.1	125.3	35.80	34.58
1122	112.2	125.4	35.84	34.61
1123	112.3	125.5	35.88	34.64
1124	112.4	125.7	35.92	34.67
1125	112.5	125.8	35.96	34.70
1126	112.6	125.9	36.00	34.72
1127	112.7	126.0	36.03	34.75
1128	112.8	126.1	36.07	34.78
1129	112.9	126.2	36.11	34.81
1130	113.0	126.3	36.15	34.84
1131	113.1	126.4	36.19	34.87
1132	113.2	126.5	36.23	34.90
1133	113.3	126.7	36.27	34.93
1134	113.4	126.8	36.31	34.96
1135	113.5	126.9	36.35	34.99
1136	113.6	127.0	36.39	35.01
1137	113.7	127.1	36.43	35.04
1138	113.8	127.2	36.47	35.07
1139	113.9	127.3	36.51	35.10
1140	114.0	127.4	36.55	35.13
1141	114.1	127.5	36.58	35.16
1142	114.2	127.7	36.62	35.19
1143	114.3	127.8	36.66	35.22
1144	114.4	127.9	36.70	35.25
1145	114.5	128.0	36.74	35.28
1146	114.6	128.1	36.78	35.30
1147	114.7	128.2	36.82	35.33
1148	114.8	128.3	36.86	35.36
1149	114.9	128.4	36.90	35.39
1150	115.0	128.6	36.94	35.42
1151	115.1	128.7	36.98	35.45
1152	115.2	128.8	37.02	35.48
1153	115.3	128.9	37.06	35.51
1154	115.4	129.0	37.10	35.54
1155	115.5	129.1	37.14	35.56
1156	115.6	129.2	37.18	35.59
1157	115.7	129.3	37.22	35.62
1158	115.8	129.4	37.26	35.65
1159	115.9	129.6	37.30	35.68
1160	116.0	129.7	37.34	35.71
1161	116.1	129.8	37.38	35.74
1162	116.2	129.9	37.42	35.77
1163	116.3	130.0	37.46	35.80
1164	116.4	130.1	37.50	35.83
1165	116.5	130.2	37.54	35.85
1166	116.6	130.3	37.58	35.88
1167	116.7	130.5	37.62	35.91
1168	116.8	130.6	37.66	35.94
1169	116.9	130.7	37.70	35.97
1170	117.0	130.8	37.74	36.00
1171	117.1	130.9	37.78	36.03
1172	117.2	131.0	37.82	36.06
1173	117.3	131.1	37.86	36.09
1174	117.4	131.2	37.90	36.11
1175	117.5	131.3	37.94	36.14
1176	117.6	131.5	37.98	36.17
1177	117.7	131.6	38.02	36.20
1178	117.8	131.7	38.06	36.23
1179	117.9	131.8	38.10	36.26
1180	118.0	131.9	38.14	36.29
1181	118.1	132.0	38.18	36.32
1182	118.2	132.1	38.22	36.35
1183	118.3	132.2	38.26	36.37
1184	118.4	132.4	38.30	36.40
1185	118.5	132.5	38.34	36.43
1186	118.6	132.6	38.38	36.46
1187	118.7	132.7	38.42	36.49
1188	118.8	132.8	38.46	36.52
1189	118.9	132.9	38.50	36.55

室内ユニット 合計容量	能力 (kW)		入力 (kW)	
	冷房	暖房	冷房	暖房
1190	119.0	133.0	38.55	36.58
1191	119.1	133.1	38.59	36.61
1192	119.2	133.2	38.63	36.64
1193	119.3	133.4	38.67	36.66
1194	119.4	133.5	38.71	36.69
1195	119.5	133.6	38.75	36.72
1196	119.6	133.7	38.79	36.75
1197	119.7	133.8	38.83	36.78
1198	119.8	133.9	38.87	36.81
1199	119.9	134.0	38.91	36.84
1200	120.0	134.1	38.95	36.87
1201	120.1	134.3	38.99	36.90
1202	120.2	134.4	39.03	36.92
1203	120.3	134.5	39.07	36.95
1204	120.4	134.6	39.12	36.98
1205	120.5	134.7	39.16	37.01
1206	120.6	134.8	39.20	37.04
1207	120.7	134.9	39.24	37.07
1208	120.8	135.0	39.28	37.10
1209	120.9	135.1	39.32	37.13
1210	121.0	135.3	39.36	37.16
1211	121.1	135.4	39.40	37.18
1212	121.2	135.5	39.44	37.21
1213	121.3	135.6	39.48	37.24
1214	121.4	135.7	39.53	37.27
1215	121.5	135.8	39.57	37.30
1216	121.6	135.9	39.61	37.33
1217	121.7	136.0	39.65	37.36
1218	121.8	136.2	39.69	37.39
1219	121.9	136.3	39.73	37.42
1220	122.0	136.4	39.77	37.44
1221	122.1	136.5	39.81	37.47
1222	122.2	136.6	39.86	37.50
1223	122.3	136.7	39.90	37.53
1224	122.4	136.8	39.94	37.56
1225	122.5	136.9	39.98	37.59
1226	122.6	137.0	40.02	37.62
1227	122.7	137.2	40.06	37.65
1228	122.8	137.3	40.10	37.67
1229	122.9	137.4	40.14	37.70
1230	123.0	137.5	40.19	37.73
1231	123.1	137.6	40.23	37.76
1232	123.2	137.7	40.27	37.79
1233	123.3	137.8	40.31	37.82
1234	123.4	137.9	40.35	37.85
1235	123.5	138.0	40.39	37.88
1236	123.6	138.2	40.44	37.91
1237	123.7	138.3	40.48	37.93
1238	123.8	138.4	40.52	37.96
1239	123.9	138.5	40.56	37.99
1240	124.0	138.6	40.60	38.02
1241	124.1	138.7	40.64	38.05
1242	124.2	138.8	40.69	38.08
1243	124.3	138.9	40.73	38.11
1244	124.4	139.1	40.77	38.14
1245	124.5	139.2	40.81	38.17
1246	124.6	139.3	40.85	38.19
1247	124.7	139.4	40.89	38.22
1248	124.8	139.5	40.94	38.25
1249	124.9	139.6	40.98	38.28
1250	125.0	139.7	41.02	38.31
1251	125.1	139.8	41.06	38.34
1252	125.2	139.9	41.10	38.37
1253	125.3	140.1	41.15	38.40
1254	125.4	140.2	41.19	38.43
1255	125.5	140.3	41.23	38.45
1256	125.6	140.4	41.27	38.48
1257	125.7	140.5	41.31	38.51
1258	125.8	140.6	41.36	38.54
1259	125.9	140.7	41.40	38.57

室内ユニット 合計容量	能力 (kW)		入力 (kW)	
	冷房	暖房	冷房	暖房
1260	126.0	140.8	41.44	38.60
1261	126.1	141.0	41.48	38.63
1262	126.2	141.1	41.53	38.66
1263	126.3	141.2	41.57	38.68
1264	126.4	141.3	41.61	38.71
1265	126.5	141.4	41.65	38.74
1266	126.6	141.5	41.69	38.77
1267	126.7	141.6	41.74	38.80
1268	126.8	141.7	41.78	38.83
1269	126.9	141.8	41.82	38.86
1270	127.0	142.0	41.86	38.89
1271	127.1	142.1	41.91	38.92
1272	127.2	142.2	41.95	38.94
1273	127.3	142.3	41.99	38.97
1274	127.4	142.4	42.03	39.00
1275	127.5	142.5	42.08	39.03
1276	127.6	142.6	42.12	39.06
1277	127.7	142.7	42.16	39.09
1278	127.8	142.9	42.20	39.12
1279	127.9	143.0	42.25	39.15
1280	128.0	143.1	42.29	39.17
1281	128.1	143.2	42.33	39.20
1282	128.2	143.3	42.37	39.23
1283	128.3	143.4	42.42	39.26
1284	128.4	143.5	42.46	39.29
1285	128.5	143.6	42.50	39.32
1286	128.6	143.7	42.55	39.35
1287	128.7	143.9	42.59	39.38
1288	128.8	144.0	42.63	39.40
1289	128.9	144.1	42.67	39.43
1290	129.0	144.2	42.72	39.46
1291	129.1	144.3	42.76	39.49
1292	129.2	144.4	42.80	39.52
1293	129.3	144.5	42.84	39.55
1294	129.4	144.6	42.89	39.58
1295	129.5	144.8	42.93	39.61
1296	129.6	144.9	42.97	39.64
1297	129.7	145.0	43.02	39.66
1298	129.8	145.1	43.06	39.69
1299	129.9	145.2	43.10	39.72
1300	130.0	145.3	43.15	39.75
1301	130.1	145.4	43.19	39.78
1302	130.2	145.5	43.23	39.81
1303	130.3	145.6	43.28	39.84
1304	130.4	145.8	43.32	39.87
1305	130.5	145.9	43.36	39.89
1306	130.6	146.0	43.40	39.92
1307	130.7	146.1	43.45	39.95
1308	130.8	146.2	43.49	39.98
1309	130.9	146.3	43.53	40.01
1310	131.0	146.4	43.58	40.04
1311	131.1	146.5	43.62	40.07
1312	131.2	146.7	43.66	40.10
1313	131.3	146.8	43.71	40.12
1314	131.4	146.9	43.75	40.15
1315	131.5	147.0	43.79	40.18
1316	131.6	147.1	43.84	40.21
1317	131.7	147.2	43.88	40.24
1318	131.8	147.3	43.93	40.27
1319	131.9	147.4	43.97	40.30
1320	132.0	147.5	44.01	40.33
1321	132.1	147.7	44.06	40.35
1322	132.2	147.8	44.10	40.38
1323	132.3	147.9	44.14	40.41
1324	132.4	148.0	44.19	40.44
1325	132.5	148.1	44.23	40.47
1326	132.6	148.2	44.27	40.50
1327	132.7	148.3	44.32	40.53
1328	132.8	148.4	44.36	40.56
1329	132.9	148.5	44.40	40.58

**【PUHY-P1400SKM-E】**

室内ユニット 合計容量	能力 (kW)		入力 (kW)	
	冷房	暖房	冷房	暖房
1330	133.0	148.7	44.45	40.61
1331	133.1	148.8	44.49	40.64
1332	133.2	148.9	44.54	40.67
1333	133.3	149.0	44.58	40.70
1334	133.4	149.1	44.62	40.73
1335	133.5	149.2	44.67	40.76
1336	133.6	149.3	44.71	40.79
1337	133.7	149.4	44.76	40.81
1338	133.8	149.6	44.80	40.84
1339	133.9	149.7	44.84	40.87
1340	134.0	149.8	44.89	40.90
1341	134.1	149.9	44.93	40.93
1342	134.2	150.0	44.98	40.96
1343	134.3	150.1	45.02	40.99
1344	134.4	150.2	45.06	41.02
1345	134.5	150.3	45.11	41.04
1346	134.6	150.4	45.15	41.07
1347	134.7	150.6	45.20	41.10
1348	134.8	150.7	45.24	41.13
1349	134.9	150.8	45.28	41.16
1350	135.0	150.9	45.33	41.19
1351	135.1	151.0	45.37	41.22
1352	135.2	151.1	45.42	41.25
1353	135.3	151.2	45.46	41.27
1354	135.4	151.3	45.51	41.30
1355	135.5	151.5	45.55	41.33
1356	135.6	151.6	45.59	41.36
1357	135.7	151.7	45.64	41.39
1358	135.8	151.8	45.68	41.42
1359	135.9	151.9	45.73	41.45
1360	136.0	152.0	45.77	41.48
1361	136.1	152.1	45.82	41.50
1362	136.2	152.2	45.86	41.53
1363	136.3	152.3	45.91	41.56
1364	136.4	152.5	45.95	41.59
1365	136.5	152.6	45.99	41.62
1366	136.6	152.7	46.04	41.65
1367	136.7	152.8	46.08	41.68
1368	136.8	152.9	46.13	41.71
1369	136.9	153.0	46.17	41.73
1370	137.0	153.1	46.22	41.76
1371	137.1	153.2	46.26	41.79
1372	137.2	153.4	46.31	41.82
1373	137.3	153.5	46.35	41.85
1374	137.4	153.6	46.40	41.88
1375	137.5	153.7	46.44	41.91
1376	137.6	153.8	46.49	41.94
1377	137.7	153.9	46.53	41.96
1378	137.8	154.0	46.58	41.99
1379	137.9	154.1	46.62	42.02
1380	138.0	154.2	46.67	42.05
1381	138.1	154.4	46.71	42.08
1382	138.2	154.5	46.76	42.11
1383	138.3	154.6	46.80	42.14
1384	138.4	154.7	46.85	42.16
1385	138.5	154.8	46.89	42.19
1386	138.6	154.9	46.94	42.22
1387	138.7	155.0	46.98	42.25
1388	138.8	155.1	47.03	42.28
1389	138.9	155.3	47.07	42.31
1390	139.0	155.4	47.12	42.34
1391	139.1	155.5	47.16	42.37
1392	139.2	155.6	47.21	42.39
1393	139.3	155.7	47.25	42.42
1394	139.4	155.8	47.30	42.45
1395	139.5	155.9	47.34	42.48
1396	139.6	156.0	47.39	42.51
1397	139.7	156.1	47.43	42.54
1398	139.8	156.3	47.48	42.57
1399	139.9	156.4	47.52	42.60

室内ユニット 合計容量	能力 (kW)		入力 (kW)	
	冷房	暖房	冷房	暖房
1400	140.0	156.5	47.56	42.63
1401	140.0	156.5	47.56	42.62
1402	140.1	156.5	47.57	42.61
1403	140.1	156.5	47.57	42.61
1404	140.1	156.5	47.57	42.60
1405	140.1	156.5	47.58	42.59
1406	140.2	156.5	47.58	42.58
1407	140.2	156.5	47.58	42.57
1408	140.2	156.6	47.59	42.56
1409	140.2	156.6	47.59	42.55
1410	140.3	156.6	47.59	42.54
1411	140.3	156.6	47.60	42.54
1412	140.3	156.6	47.60	42.53
1413	140.3	156.6	47.60	42.52
1414	140.4	156.6	47.61	42.51
1415	140.4	156.6	47.61	42.50
1416	140.4	156.6	47.62	42.49
1417	140.4	156.6	47.62	42.48
1418	140.5	156.6	47.62	42.48
1419	140.5	156.6	47.63	42.47
1420	140.5	156.6	47.63	42.46
1421	140.5	156.6	47.63	42.45
1422	140.6	156.6	47.64	42.44
1423	140.6	156.6	47.64	42.43
1424	140.6	156.6	47.64	42.42
1425	140.6	156.6	47.65	42.42
1426	140.7	156.6	47.65	42.41
1427	140.7	156.6	47.65	42.40
1428	140.7	156.6	47.66	42.39
1429	140.7	156.6	47.66	42.38
1430	140.8	156.7	47.67	42.37
1431	140.8	156.7	47.67	42.36
1432	140.8	156.7	47.67	42.35
1433	140.8	156.7	47.68	42.35
1434	140.9	156.7	47.68	42.34
1435	140.9	156.7	47.68	42.33
1436	140.9	156.7	47.69	42.32
1437	140.9	156.7	47.69	42.31
1438	141.0	156.7	47.69	42.30
1439	141.0	156.7	47.70	42.29
1440	141.0	156.7	47.70	42.29
1441	141.0	156.7	47.70	42.28
1442	141.1	156.7	47.71	42.27
1443	141.1	156.7	47.71	42.26
1444	141.1	156.7	47.71	42.25
1445	141.1	156.7	47.72	42.24
1446	141.2	156.7	47.72	42.23
1447	141.2	156.7	47.73	42.23
1448	141.2	156.7	47.73	42.22
1449	141.2	156.7	47.73	42.21
1450	141.3	156.7	47.74	42.20
1451	141.3	156.7	47.74	42.19
1452	141.3	156.8	47.74	42.18
1453	141.3	156.8	47.75	42.17
1454	141.4	156.8	47.75	42.16
1455	141.4	156.8	47.75	42.16
1456	141.4	156.8	47.76	42.15
1457	141.4	156.8	47.76	42.14
1458	141.5	156.8	47.76	42.13
1459	141.5	156.8	47.77	42.12
1460	141.5	156.8	47.77	42.11
1461	141.6	156.8	47.78	42.10
1462	141.6	156.8	47.78	42.10
1463	141.6	156.8	47.78	42.09
1464	141.6	156.8	47.79	42.08
1465	141.7	156.8	47.79	42.07
1466	141.7	156.8	47.79	42.06
1467	141.7	156.8	47.80	42.05
1468	141.7	156.8	47.80	42.04
1469	141.8	156.8	47.80	42.04

室内ユニット 合計容量	能力 (kW)		入力 (kW)	
	冷房	暖房	冷房	暖房
1470	141.8	156.8	47.81	42.03
1471	141.8	156.8	47.81	42.02
1472	141.8	156.8	47.81	42.01
1473	141.9	156.8	47.82	42.00
1474	141.9	156.9	47.82	41.99
1475	141.9	156.9	47.83	41.98
1476	141.9	156.9	47.83	41.97
1477	142.0	156.9	47.83	41.97
1478	142.0	156.9	47.84	41.96
1479	142.0	156.9	47.84	41.95
1480	142.0	156.9	47.84	41.94
1481	142.1	156.9	47.85	41.93
1482	142.1	156.9	47.85	41.92
1483	142.1	156.9	47.85	41.91
1484	142.1	156.9	47.86	41.91
1485	142.2	156.9	47.86	41.90
1486	142.2	156.9	47.86	41.89
1487	142.2	156.9	47.87	41.88
1488	142.2	156.9	47.87	41.87
1489	142.3	156.9	47.87	41.86
1490	142.3	156.9	47.88	41.85
1491	142.3	156.9	47.88	41.85
1492	142.3	156.9	47.89	41.84
1493	142.4	156.9	47.89	41.83
1494	142.4	156.9	47.89	41.82
1495	142.4	156.9	47.90	41.81
1496	142.4	157.0	47.90	41.80
1497	142.5	157.0	47.90	41.79
1498	142.5	157.0	47.91	41.78
1499	142.5	157.0	47.91	41.78
1500	142.5	157.0	47.91	41.77
1501	142.6	157.0	47.92	41.76
1502	142.6	157.0	47.92	41.75
1503	142.6	157.0	47.92	41.74
1504	142.6	157.0	47.93	41.73
1505	142.7	157.0	47.93	41.72
1506	142.7	157.0	47.94	41.72
1507	142.7	157.0	47.94	41.71
1508	142.7	157.0	47.94	41.70
1509	142.8	157.0	47.95	41.69
1510	142.8	157.0	47.95	41.68
1511	142.8	157.0	47.95	41.67
1512	142.8	157.0	47.96	41.66
1513	142.9	157.0	47.96	41.66
1514	142.9	157.0	47.96	41.65
1515	142.9	157.0	47.97	41.64
1516	142.9	157.0	47.97	41.63
1517	143.0	157.0	47.97	41.62
1518	143.0	157.1	47.98	41.61
1519	143.0	157.1	47.98	41.60
1520	143.0	157.1	47.99	41.59
1521	143.1	157.1	47.99	41.59
1522	143.1	157.1	47.99	41.58
1523	143.1	157.1	48.00	41.57
1524	143.1	157.1	48.00	41.56
1525	143.2	157.1	48.00	41.55
1526	143.2	157.1	48.01	41.54
1527	143.2	157.1	48.01	41.53
1528	143.3	157.1	48.01	41.53
1529	143.3	157.1	48.02	41.52
1530	143.3	157.1	48.02	41.51
1531	143.3	157.1	48.02	41.50
1532	143.4	157.1	48.03	41.49
1533	143.4	157.1	48.03	41.48
1534	143.4	157.1	48.03	41.47
1535	143.4	157.1	48.04	41.47
1536	143.5	157.1	48.04	41.46
1537	143.5	157.1	48.05	41.45
1538	143.5	157.1	48.05	41.44
1539	143.5	157.1	48.05	41.43

【PUHY-P1400SKM-E】

室内ユニット 合計容量	能力 (kW)		入力 (kW)	
	冷房	暖房	冷房	暖房
1540	143.6	157.2	48.06	41.42
1541	143.6	157.2	48.06	41.41
1542	143.6	157.2	48.06	41.40
1543	143.6	157.2	48.07	41.40
1544	143.7	157.2	48.07	41.39
1545	143.7	157.2	48.07	41.38
1546	143.7	157.2	48.08	41.37
1547	143.7	157.2	48.08	41.36
1548	143.8	157.2	48.08	41.35
1549	143.8	157.2	48.09	41.34
1550	143.8	157.2	48.09	41.34
1551	143.8	157.2	48.10	41.33
1552	143.9	157.2	48.10	41.32
1553	143.9	157.2	48.10	41.31
1554	143.9	157.2	48.11	41.30
1555	143.9	157.2	48.11	41.29
1556	144.0	157.2	48.11	41.28
1557	144.0	157.2	48.12	41.28
1558	144.0	157.2	48.12	41.27
1559	144.0	157.2	48.12	41.26
1560	144.1	157.2	48.13	41.25
1561	144.1	157.2	48.13	41.24
1562	144.1	157.2	48.13	41.23
1563	144.1	157.3	48.14	41.22
1564	144.2	157.3	48.14	41.21
1565	144.2	157.3	48.15	41.21
1566	144.2	157.3	48.15	41.20
1567	144.2	157.3	48.15	41.19
1568	144.3	157.3	48.16	41.18
1569	144.3	157.3	48.16	41.17
1570	144.3	157.3	48.16	41.16
1571	144.3	157.3	48.17	41.15
1572	144.4	157.3	48.17	41.15
1573	144.4	157.3	48.17	41.14
1574	144.4	157.3	48.18	41.13
1575	144.4	157.3	48.18	41.12
1576	144.5	157.3	48.18	41.11
1577	144.5	157.3	48.19	41.10
1578	144.5	157.3	48.19	41.09
1579	144.5	157.3	48.19	41.09
1580	144.6	157.3	48.20	41.08
1581	144.6	157.3	48.20	41.07
1582	144.6	157.3	48.21	41.06
1583	144.6	157.3	48.21	41.05
1584	144.7	157.3	48.21	41.04
1585	144.7	157.4	48.22	41.03
1586	144.7	157.4	48.22	41.02
1587	144.7	157.4	48.22	41.02
1588	144.8	157.4	48.23	41.01
1589	144.8	157.4	48.23	41.00
1590	144.8	157.4	48.23	40.99
1591	144.8	157.4	48.24	40.98
1592	144.9	157.4	48.24	40.97
1593	144.9	157.4	48.24	40.96
1594	144.9	157.4	48.25	40.96
1595	144.9	157.4	48.25	40.95
1596	145.0	157.4	48.26	40.94
1597	145.0	157.4	48.26	40.93
1598	145.0	157.4	48.26	40.92
1599	145.1	157.4	48.27	40.91
1600	145.1	157.4	48.27	40.90
1601	145.1	157.4	48.27	40.90
1602	145.1	157.4	48.28	40.89
1603	145.2	157.4	48.28	40.88
1604	145.2	157.4	48.28	40.87
1605	145.2	157.4	48.29	40.86
1606	145.2	157.4	48.29	40.85
1607	145.3	157.5	48.29	40.84
1608	145.3	157.5	48.30	40.83
1609	145.3	157.5	48.30	40.83

室内ユニット 合計容量	能力 (kW)		入力 (kW)	
	冷房	暖房	冷房	暖房
1610	145.3	157.5	48.31	40.82
1611	145.4	157.5	48.31	40.81
1612	145.4	157.5	48.31	40.80
1613	145.4	157.5	48.32	40.79
1614	145.4	157.5	48.32	40.78
1615	145.5	157.5	48.32	40.77
1616	145.5	157.5	48.33	40.77
1617	145.5	157.5	48.33	40.76
1618	145.5	157.5	48.33	40.75
1619	145.6	157.5	48.34	40.74
1620	145.6	157.5	48.34	40.73
1621	145.6	157.5	48.34	40.72
1622	145.6	157.5	48.35	40.71
1623	145.7	157.5	48.35	40.71
1624	145.7	157.5	48.35	40.70
1625	145.7	157.5	48.36	40.69
1626	145.7	157.5	48.36	40.68
1627	145.8	157.5	48.37	40.67
1628	145.8	157.5	48.37	40.66
1629	145.8	157.6	48.37	40.65
1630	145.8	157.6	48.38	40.64
1631	145.9	157.6	48.38	40.64
1632	145.9	157.6	48.38	40.63
1633	145.9	157.6	48.39	40.62
1634	145.9	157.6	48.39	40.61
1635	146.0	157.6	48.39	40.60
1636	146.0	157.6	48.40	40.59
1637	146.0	157.6	48.40	40.58
1638	146.0	157.6	48.40	40.58
1639	146.1	157.6	48.41	40.57
1640	146.1	157.6	48.41	40.56
1641	146.1	157.6	48.42	40.55
1642	146.1	157.6	48.42	40.54
1643	146.2	157.6	48.42	40.53
1644	146.2	157.6	48.43	40.52
1645	146.2	157.6	48.43	40.52
1646	146.2	157.6	48.43	40.51
1647	146.3	157.6	48.44	40.50
1648	146.3	157.6	48.44	40.49
1649	146.3	157.6	48.44	40.48
1650	146.3	157.6	48.45	40.47
1651	146.4	157.7	48.45	40.46
1652	146.4	157.7	48.45	40.45
1653	146.4	157.7	48.46	40.45
1654	146.4	157.7	48.46	40.44
1655	146.5	157.7	48.47	40.43
1656	146.5	157.7	48.47	40.42
1657	146.5	157.7	48.47	40.41
1658	146.5	157.7	48.48	40.40
1659	146.6	157.7	48.48	40.39
1660	146.6	157.7	48.48	40.39
1661	146.6	157.7	48.49	40.38
1662	146.6	157.7	48.49	40.37
1663	146.7	157.7	48.49	40.36
1664	146.7	157.7	48.50	40.35
1665	146.7	157.7	48.50	40.34
1666	146.7	157.7	48.50	40.33
1667	146.8	157.7	48.51	40.33
1668	146.8	157.7	48.51	40.32
1669	146.8	157.7	48.51	40.31
1670	146.9	157.7	48.52	40.30
1671	146.9	157.7	48.52	40.29
1672	146.9	157.7	48.53	40.28
1673	146.9	157.8	48.53	40.27
1674	147.0	157.8	48.53	40.27
1675	147.0	157.8	48.54	40.26
1676	147.0	157.8	48.54	40.25
1677	147.0	157.8	48.54	40.24
1678	147.1	157.8	48.55	40.23
1679	147.1	157.8	48.55	40.22

室内ユニット 合計容量	能力 (kW)		入力 (kW)	
	冷房	暖房	冷房	暖房
1680	147.1	157.8	48.55	40.21
1681	147.1	157.8	48.56	40.20
1682	147.2	157.8	48.56	40.20
1683	147.2	157.8	48.56	40.19
1684	147.2	157.8	48.57	40.18
1685	147.2	157.8	48.57	40.17
1686	147.3	157.8	48.58	40.16
1687	147.3	157.8	48.58	40.15
1688	147.3	157.8	48.58	40.14
1689	147.3	157.8	48.59	40.14
1690	147.4	157.8	48.59	40.13
1691	147.4	157.8	48.59	40.12
1692	147.4	157.8	48.60	40.11
1693	147.4	157.8	48.60	40.10
1694	147.5	157.8	48.60	40.09
1695	147.5	157.8	48.61	40.08
1696	147.5	157.9	48.61	40.08
1697	147.5	157.9	48.61	40.07
1698	147.6	157.9	48.62	40.06
1699	147.6	157.9	48.62	40.05
1700	147.6	157.9	48.63	40.04
1701	147.6	157.9	48.63	40.03
1702	147.7	157.9	48.63	40.02
1703	147.7	157.9	48.64	40.01
1704	147.7	157.9	48.64	40.01
1705	147.7	157.9	48.64	40.00
1706	147.8	157.9	48.65	39.99
1707	147.8	157.9	48.65	39.98
1708	147.8	157.9	48.65	39.97
1709	147.8	157.9	48.66	39.96
1710	147.9	157.9	48.66	39.95
1711	147.9	157.9	48.66	39.95
1712	147.9	157.9	48.67	39.94
1713	147.9	157.9	48.67	39.93
1714	148.0	157.9	48.67	39.92
1715	148.0	157.9	48.68	39.91
1716	148.0	157.9	48.68	39.90
1717	148.0	157.9	48.69	39.89
1718	148.1	158.0	48.69	39.89
1719	148.1	158.0	48.69	39.88
1720	148.1	158.0	48.70	39.87
1721	148.1	158.0	48.70	39.86
1722	148.2	158.0	48.70	39.85
1723	148.2	158.0	48.71	39.84
1724	148.2	158.0	48.71	39.83
1725	148.2	158.0	48.71	39.82
1726	148.3	158.0	48.72	39.82
1727	148.3	158.0	48.72	39.81
1728	148.3	158.0	48.72	39.80
1729	148.3	158.0	48.73	39.79
1730	148.4	158.0	48.73	39.78
1731	148.4	158.0	48.74	39.77
1732	148.4	158.0	48.74	39.76
1733	148.4	158.0	48.74	39.76
1734	148.5	158.0	48.75	39.75
1735	148.5	158.0	48.75	39.74
1736	148.5	158.0	48.75	39.73
1737	148.6	158.0	48.76	39.72
1738	148.6	158.0	48.76	39.71
1739	148.6	158.0	48.76	39.70
1740	148.6	158.1	48.77	39.70
1741	148.7	158.1	48.77	39.69
1742	148.7	158.1	48.77	39.68
1743	148.7	158.1	48.78	39.67
1744	148.7	158.1	48.78	39.66
1745	148.8	158.1	48.79	39.65
1746	148.8	158.1	48.79	39.64
1747	148.8	158.1	48.79	39.63
1748	148.8	158.1	48.80	39.63
1749	148.9	158.1	48.80	39.62

## 【PUHY-P1400SKM-E】

室内ユニット 合計容量	能力 (kW)		入力 (kW)	
	冷房	暖房	冷房	暖房
1750	148.9	158.1	48.80	39.61
1751	148.9	158.1	48.81	39.60
1752	148.9	158.1	48.81	39.59
1753	149.0	158.1	48.81	39.58
1754	149.0	158.1	48.82	39.57
1755	149.0	158.1	48.82	39.57
1756	149.0	158.1	48.82	39.56
1757	149.1	158.1	48.83	39.55
1758	149.1	158.1	48.83	39.54
1759	149.1	158.1	48.84	39.53
1760	149.1	158.1	48.84	39.52
1761	149.2	158.1	48.84	39.51
1762	149.2	158.2	48.85	39.51
1763	149.2	158.2	48.85	39.50
1764	149.2	158.2	48.85	39.49
1765	149.3	158.2	48.86	39.48
1766	149.3	158.2	48.86	39.47
1767	149.3	158.2	48.86	39.46
1768	149.3	158.2	48.87	39.45
1769	149.4	158.2	48.87	39.44
1770	149.4	158.2	48.87	39.44
1771	149.4	158.2	48.88	39.43
1772	149.4	158.2	48.88	39.42
1773	149.5	158.2	48.88	39.41
1774	149.5	158.2	48.89	39.40
1775	149.5	158.2	48.89	39.39
1776	149.5	158.2	48.90	39.38
1777	149.6	158.2	48.90	39.38
1778	149.6	158.2	48.90	39.37
1779	149.6	158.2	48.91	39.36
1780	149.6	158.2	48.91	39.35
1781	149.7	158.2	48.91	39.34
1782	149.7	158.2	48.92	39.33
1783	149.7	158.2	48.92	39.32
1784	149.7	158.3	48.92	39.32
1785	149.8	158.3	48.93	39.31
1786	149.8	158.3	48.93	39.30
1787	149.8	158.3	48.93	39.29
1788	149.8	158.3	48.94	39.28
1789	149.9	158.3	48.94	39.27
1790	149.9	158.3	48.95	39.26
1791	149.9	158.3	48.95	39.25
1792	149.9	158.3	48.95	39.25
1793	150.0	158.3	48.96	39.24
1794	150.0	158.3	48.96	39.23
1795	150.0	158.3	48.96	39.22
1796	150.0	158.3	48.97	39.21
1797	150.1	158.3	48.97	39.20
1798	150.1	158.3	48.97	39.19
1799	150.1	158.3	48.98	39.19
1800	150.1	158.3	48.98	39.18
1801	150.2	158.3	48.98	39.17
1802	150.2	158.3	48.99	39.16
1803	150.2	158.3	48.99	39.15
1804	150.2	158.3	49.00	39.14
1805	150.3	158.3	49.00	39.13
1806	150.3	158.4	49.00	39.13
1807	150.3	158.4	49.01	39.12
1808	150.4	158.4	49.01	39.11
1809	150.4	158.4	49.01	39.10
1810	150.4	158.4	49.02	39.09
1811	150.4	158.4	49.02	39.08
1812	150.5	158.4	49.02	39.07
1813	150.5	158.4	49.03	39.06
1814	150.5	158.4	49.03	39.06
1815	150.5	158.4	49.03	39.05
1816	150.6	158.4	49.04	39.04
1817	150.6	158.4	49.04	39.03
1818	150.6	158.4	49.04	39.02
1819	150.6	158.4	49.05	39.01

室内ユニット 合計容量	能力 (kW)		入力 (kW)	
	冷房	暖房	冷房	暖房
1820	150.6	158.4	49.05	39.00

## b. 空気条件変化による補正

[PUHY-P960・P1010・P1080・P1130・P1180・P1240・P1300・P1360・P1400SKM-E]

・冷房能力・入力補正

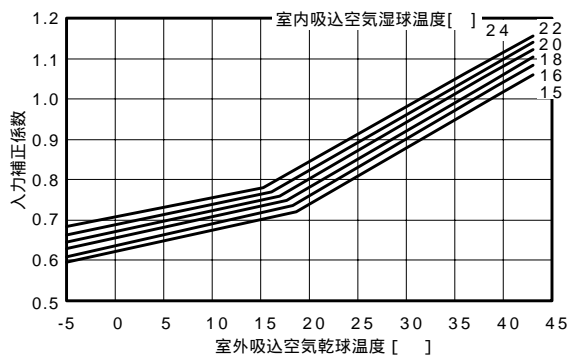
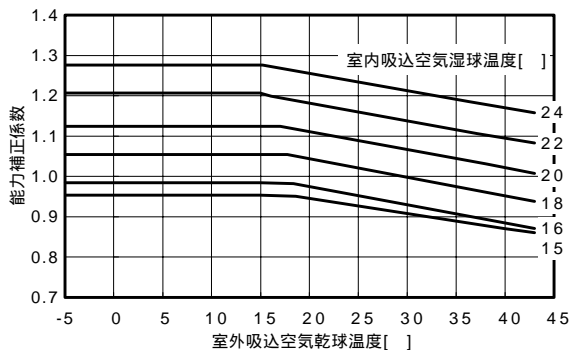

・暖房能力・入力補正

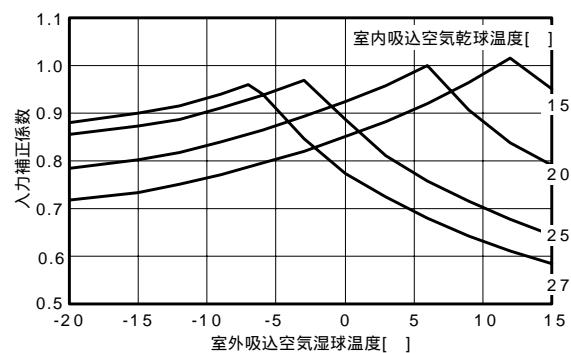
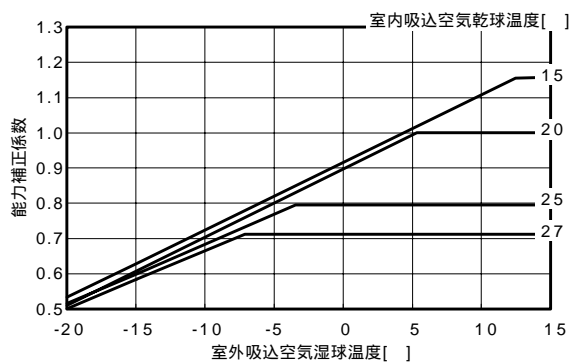

・冷房能力・入力補正（オールフレッシュ）

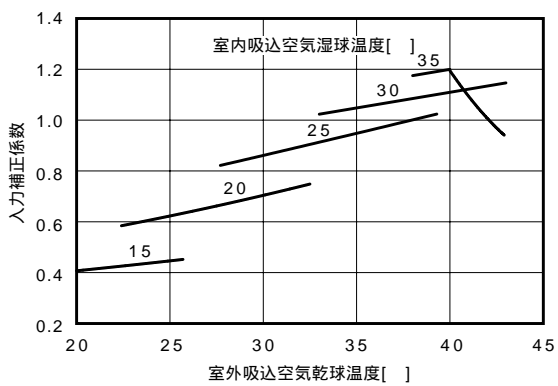
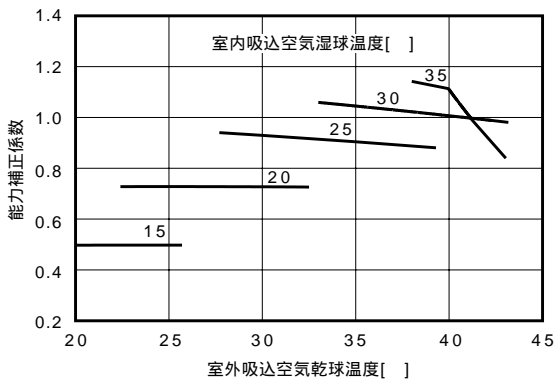

・暖房能力・入力補正（オールフレッシュ）

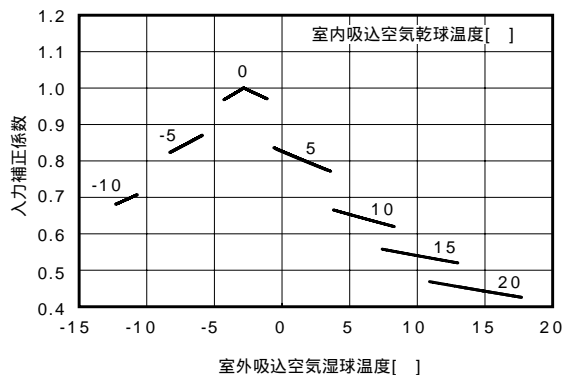
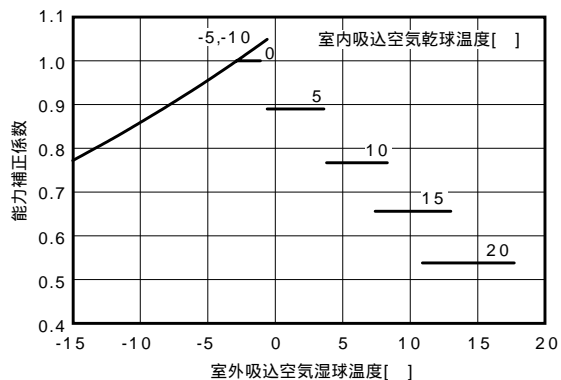

c. 冷媒配管長補正

【冷房能力補正係数】

【PUHY-P960SKM-E】

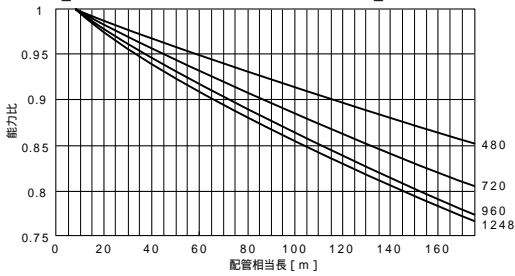

【PUHY-P1010SKM-E】

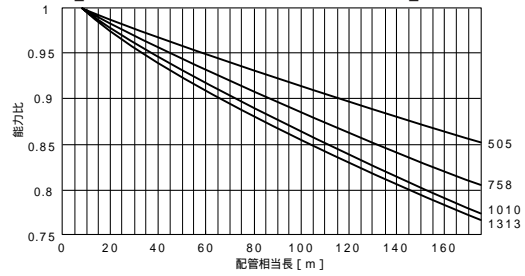

【PUHY-P1080SKM-E】

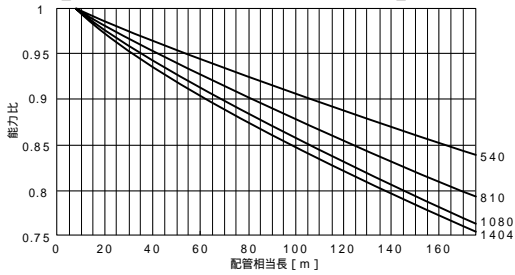

【PUHY-P1130SKM-E】

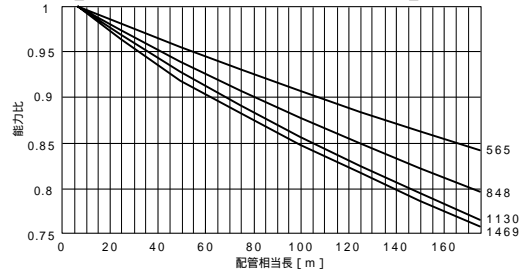

【PUHY-P1180SKM-E】

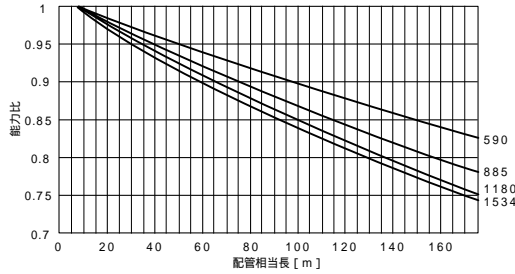

【PUHY-P1240SKM-E】

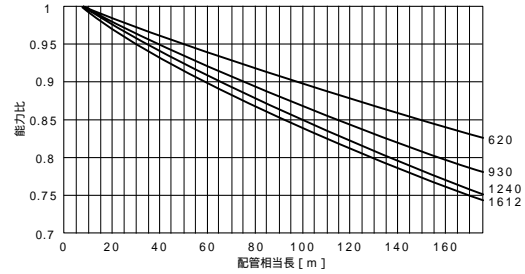

【PUHY-P1300SKM-E】

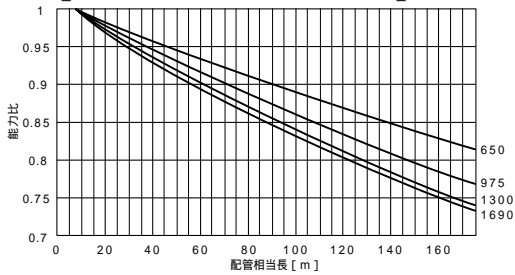

【PUHY-P1360SKM-E】

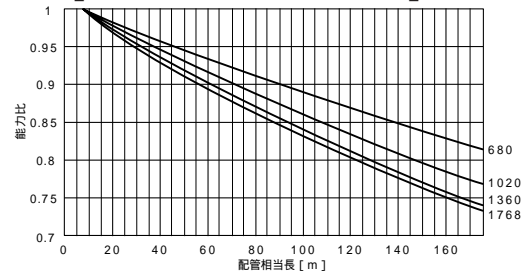

【PUHY-P1400SKM-E】

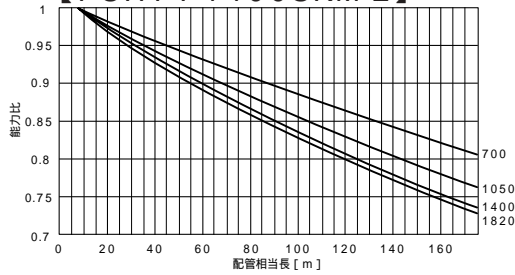

【暖房能力補正係数】

【PUHY-P960・P1010・P1080・P1130SKM-E】

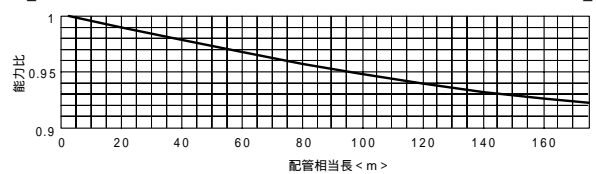

【PUHY-P1180・P1240・P1360・P1400SKM-E】

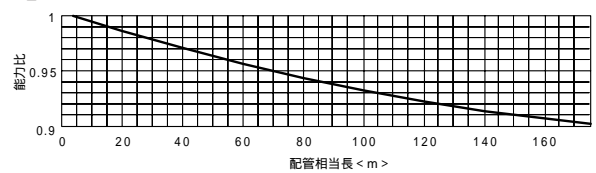

【配管相当長の求め方】

PUHY-P960~P1400SKM-E形 相当長 = (最遠室内ユニットまでの配管実長) + (0.80 × 配管途中のベンド数) m

d. 霜取補正

室外吸込空気温度 < 湿球温度 >	6	4	2	1	0	-2	-4	-6	-8	-10	
霜取補正係数	P960-P1400形	1.0	0.94	0.87	0.86	0.87	0.88	0.90	0.90	0.93	0.93



## 2. 室外ユニットの騒音

### (1) 騒音レベル

P140～P450

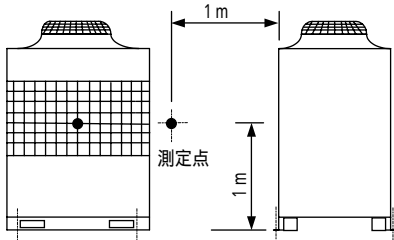

形名	騒音値(dB[A特性])
PUHY-P140M-E(-BS,-BSG)	55
PUHY-P160M-E(-BS,-BSG)	56
PUHY-P224M-E(-BS,-BSG)	56
PUHY-P280M-E(-BS,-BSG)	57
PUHY-P335M-E(-BS,-BSG)	59
PUHY-P355M-E(-BS,-BSG)	60
PUHY-P400M-E(-BS,-BSG)	60
PUHY-P450M-E(-BS,-BSG)	61

P500～P730

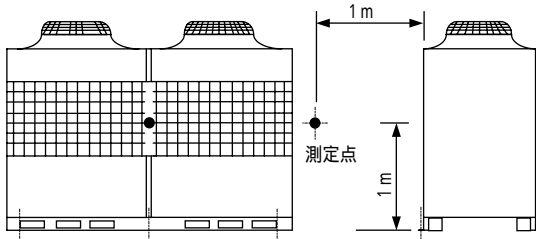

形名	騒音値(dB[A特性])
PUHY-P500M-E(-BS,-BSG)	60/61
PUHY-P560M-E(-BS,-BSG)	60/61
PUHY-P630M-E(-BS,-BSG)	61/62
PUHY-P674M-E(-BS,-BSG)	61/62
PUHY-P730M-E(-BS,-BSG)	62/62.5

P784～P900

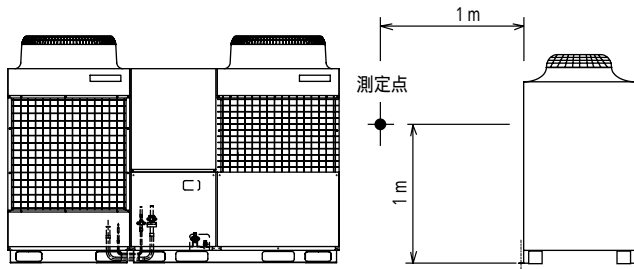

形名	騒音値(dB[A特性])
PUHY-P784SM-E(-BS,-BSG)	62
PUHY-P840SM-E(-BS,-BSG)	63
PUHY-P900SM-E(-BS,-BSG)	64

P960～P1400

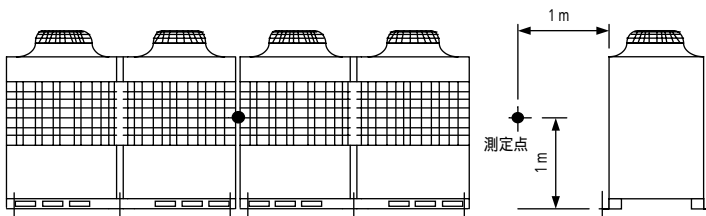

形名	騒音値(dB[A特性])
PUHY-P960SKM-E(-BS,-BSG)	63 / 64
PUHY-P1010SKM-E(-BS,-BSG)	63 / 64
PUHY-P1080SKM-E(-BS,-BSG)	63 / 64
PUHY-P1130SKM-E(-BS,-BSG)	63 / 64
PUHY-P1180SKM-E(-BS,-BSG)	63.5 / 64.5
PUHY-P1240SKM-E(-BS,-BSG)	64 / 65
PUHY-P1300SKM-E(-BS,-BSG)	64 / 65
PUHY-P1360SKM-E(-BS,-BSG)	64 / 65
PUHY-P1400SKM-E(-BS,-BSG)	65 / 65.5

## (2) NC曲線

PUHY-P140M-E(-BS,-BSG)形

63Hz	125Hz	250Hz	500Hz	1000Hz	2000Hz	4000Hz	8000Hz	A特性(dB)
67.5	62	56.5	52.5	48	45.5	38.5	36	55

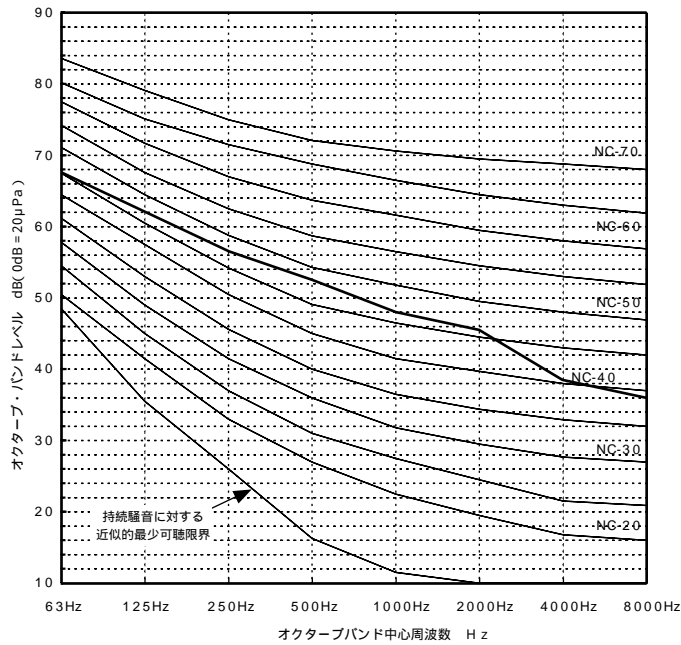

PUHY-P160M-E(-BS,-BSG)形

63Hz	125Hz	250Hz	500Hz	1000Hz	2000Hz	4000Hz	8000Hz	A特性(dB)
63	59.5	57	53	50	48	40.5	40	56

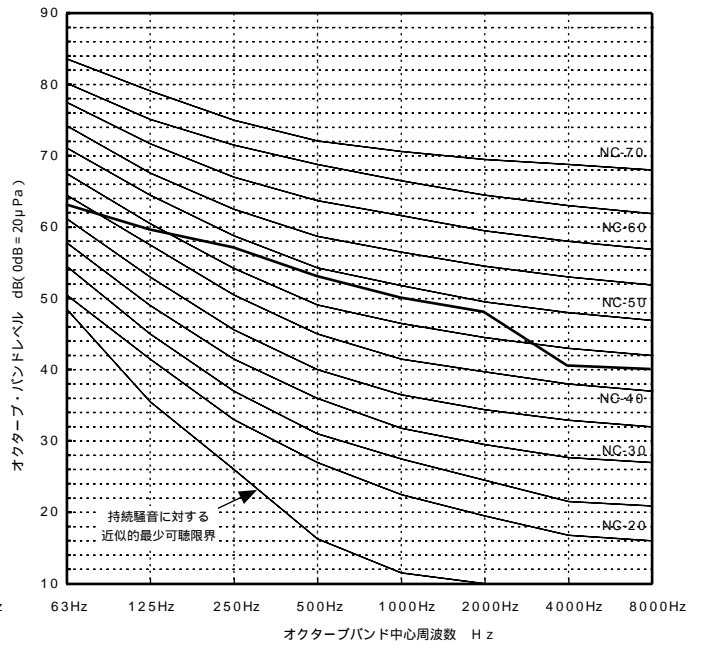

PUHY-P224M-E(-BS,-BSG)形

63Hz	125Hz	250Hz	500Hz	1000Hz	2000Hz	4000Hz	8000Hz	A特性(dB)
62	58	56	52.5	49.5	50	41.5	38	56

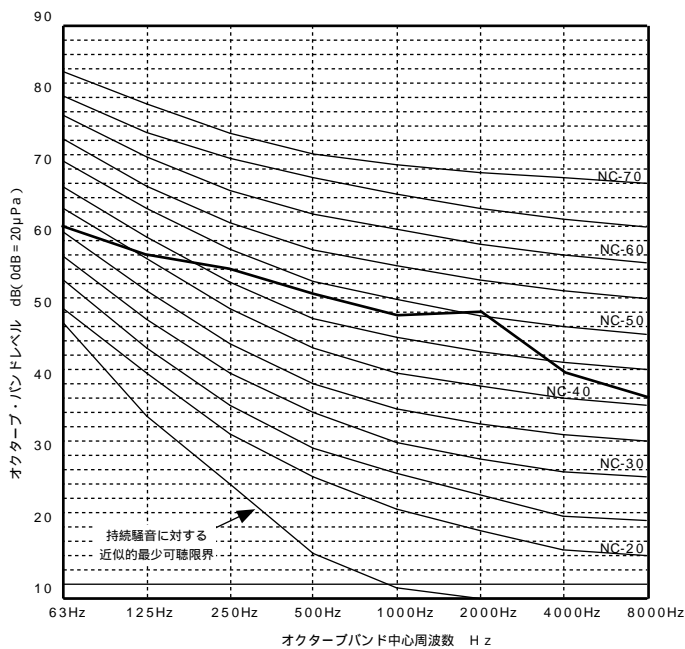

PUHY-P280M-E(-BS,-BSG)形

63Hz	125Hz	250Hz	500Hz	1000Hz	2000Hz	4000Hz	8000Hz	A特性(dB)
62.5	58.5	55.5	53	49.5	49	49	43	57

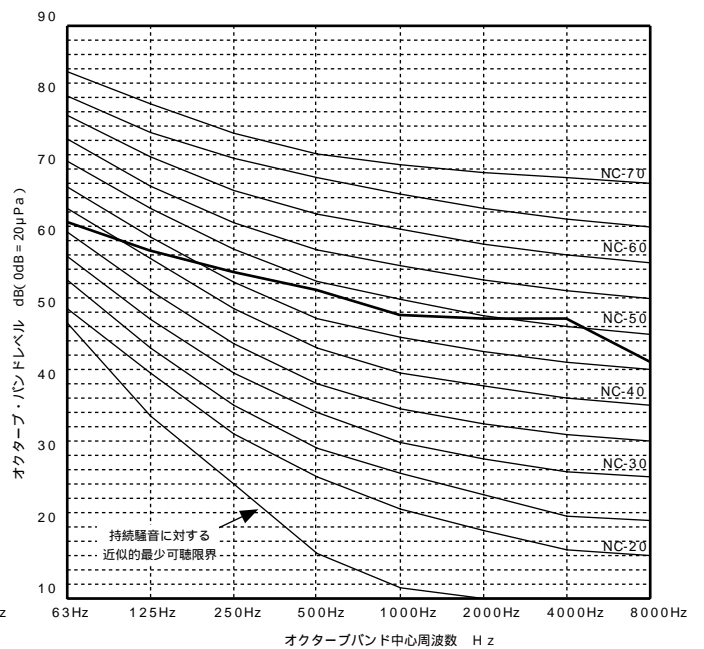

PUHY-P335M-E(-BS,-BSG)形

63Hz	125Hz	250Hz	500Hz	1000Hz	2000Hz	4000Hz	8000Hz	A特性(dB)
65	61	58	55	51.5	51	51	45.5	59

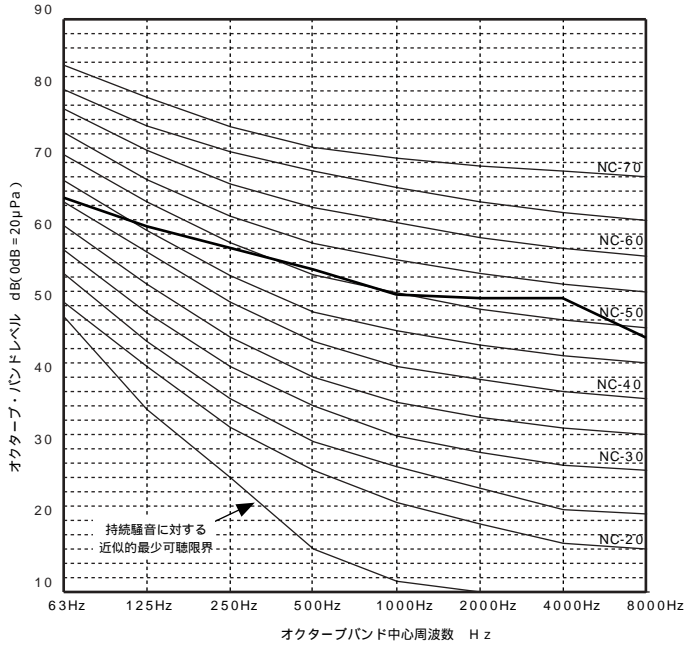

PUHY-P355EM-E(-BS,-BSG)形

63Hz	125Hz	250Hz	500Hz	1000Hz	2000Hz	4000Hz	8000Hz	A特性(dB)
63	64	57.5	55	50.5	50.5	54	50	60

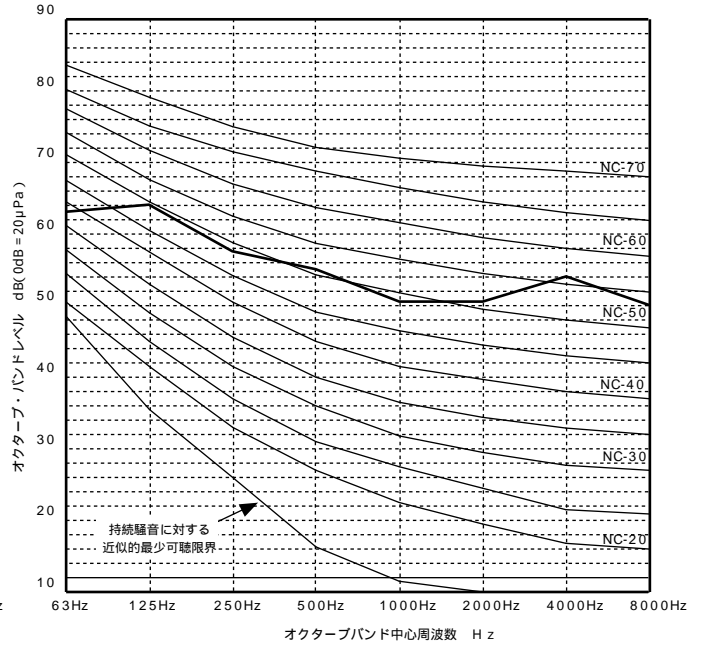

PUHY-P400M-E(-BS,-BSG)形

63Hz	125Hz	250Hz	500Hz	1000Hz	2000Hz	4000Hz	8000Hz	A特性(dB)
63	64	57.5	55	50.5	50.5	54	50	60

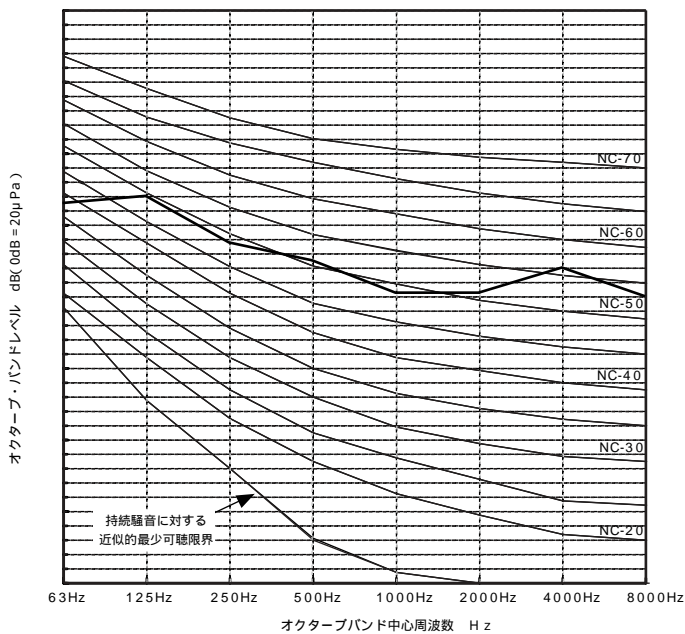

PUHY-P450M-E(-BS,-BSG)形

63Hz	125Hz	250Hz	500Hz	1000Hz	2000Hz	4000Hz	8000Hz	A特性(dB)
67.5	68.5	60.5	58.5	54.5	50.5	48.5	43	61

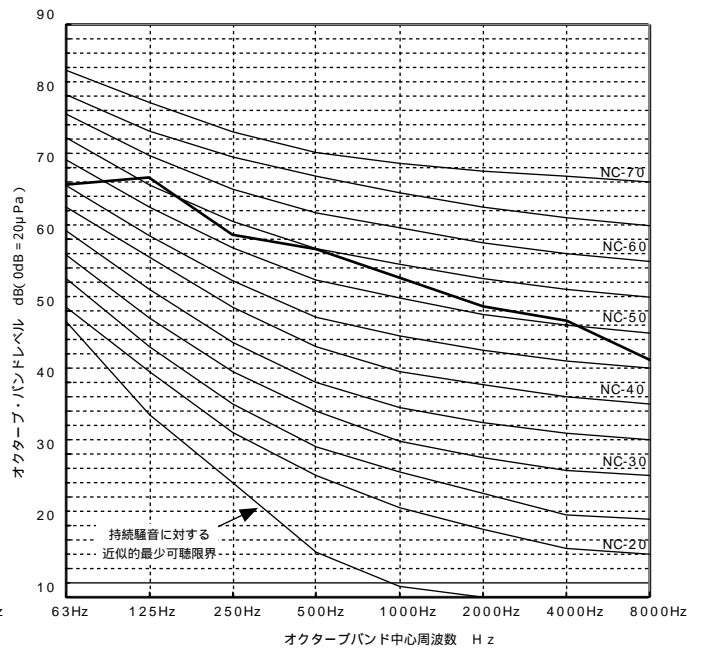

PUHY-P500M-E(-BS,-BSG)形

	63Hz	125Hz	250Hz	500Hz	1000Hz	2000Hz	4000Hz	8000Hz	A特性(dB)
50Hz	66.5	62.5	60.5	58	53.5	50.5	46	41.5	60
60Hz	70.5	64.5	61	59.5	54.5	51	47	41	61

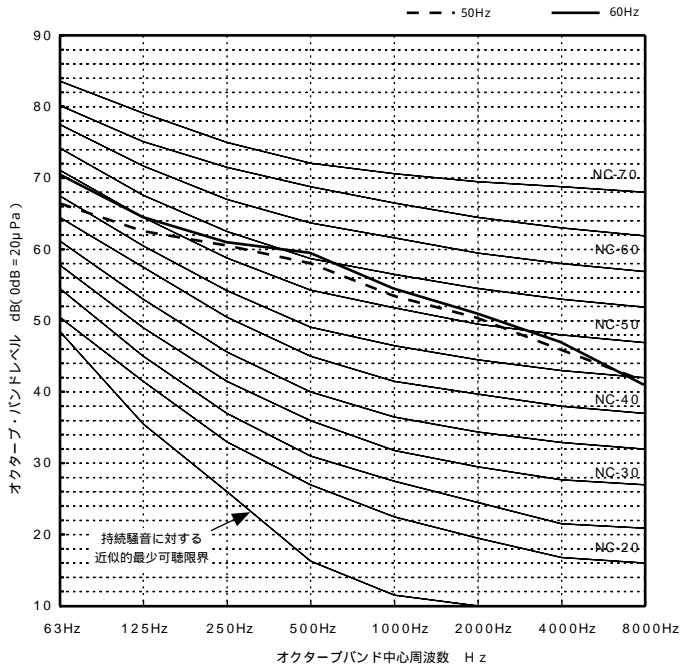

PUHY-P560M-E(-BS,-BSG)形

	63Hz	125Hz	250Hz	500Hz	1000Hz	2000Hz	4000Hz	8000Hz	A特性(dB)
50Hz	67	61.5	60.5	58	53.5	50.5	48	43	60
60Hz	68	65	60.5	59	54	51.5	49	43.5	61

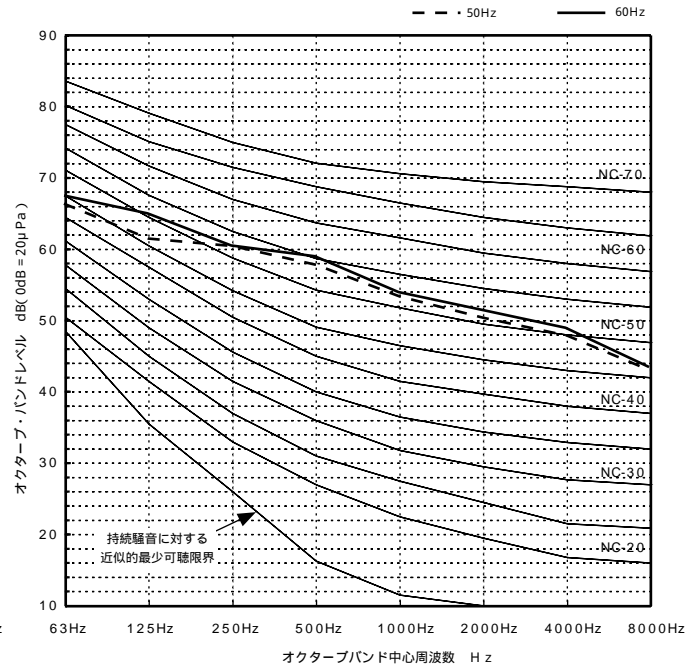

PUHY-P630M-E(-BS,-BSG)形

	63Hz	125Hz	250Hz	500Hz	1000Hz	2000Hz	4000Hz	8000Hz	A特性(dB)
50Hz	67	61	62	59	54	52.5	49.5	44	61
60Hz	66.5	65.5	61.5	60	55	51.5	51.5	46	62

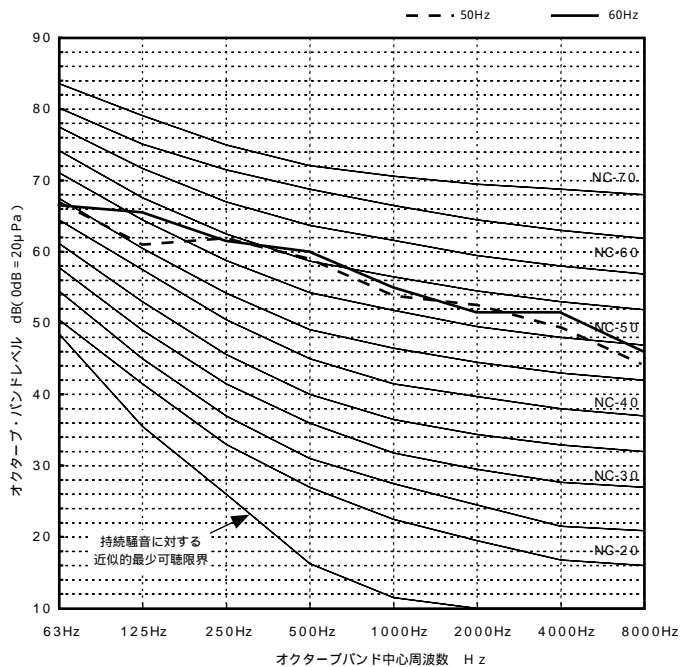

PUHY-P674M-E(-BS,-BSG)形

	63Hz	125Hz	250Hz	500Hz	1000Hz	2000Hz	4000Hz	8000Hz	A特性(dB)
50Hz	69	66.5	62	58	53.5	51.5	51	46	61
60Hz	65	66.5	63	59	54	52.5	51.5	46.5	62

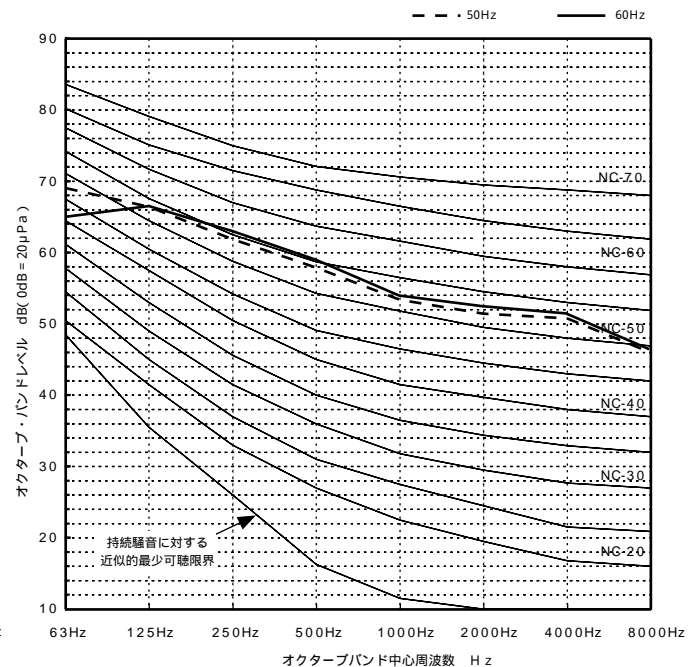

PUHY-P730M-E(-BS,-BSG)形

	63Hz	125Hz	250Hz	500Hz	1000Hz	2000Hz	4000Hz	8000Hz	A特性(dB)
標準	69.5	63	61.5	59.5	54.5	52.5	54	47	62
ナイトモード	65	67	62	59.5	55	53	54.5	49	62.5

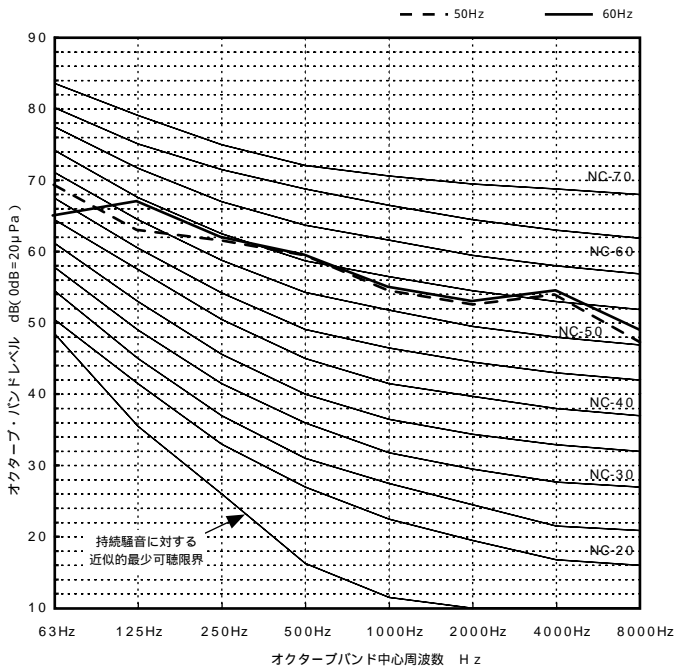

PUHY-P784SM-E(-BS,-BSG)形

	63Hz	125Hz	250Hz	500Hz	1000Hz	2000Hz	4000Hz	8000Hz	A特性(dB)
標準	65.5	63	64	60	55	52	50.5	47	62
ナイトモード	58	55.5	57	53	44.5	41.5	41.5	42	54

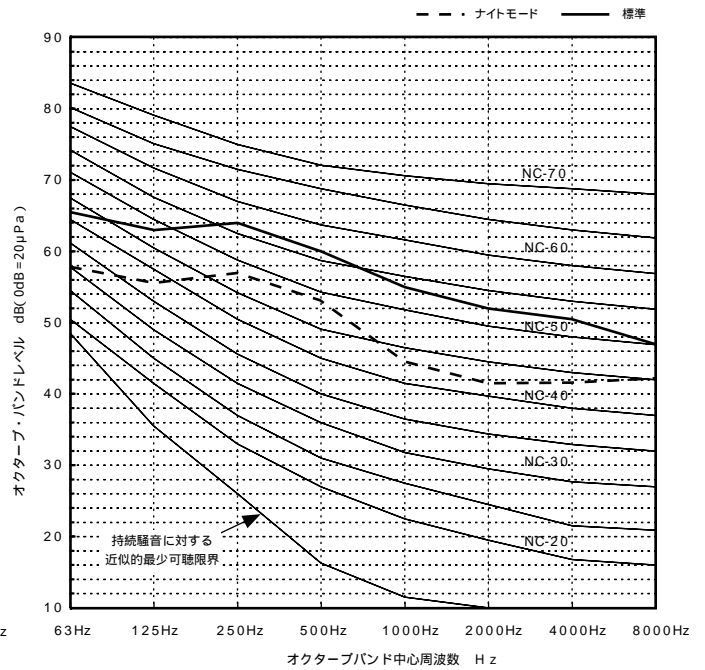

PUHY-P840SM-E(-BS,-BSG)形

	63Hz	125Hz	250Hz	500Hz	1000Hz	2000Hz	4000Hz	8000Hz	A特性(dB)
標準	65	63.5	64.5	61	56.5	53	51	47	63
ナイトモード	58	57	58	54	45.5	43	43	43.5	55

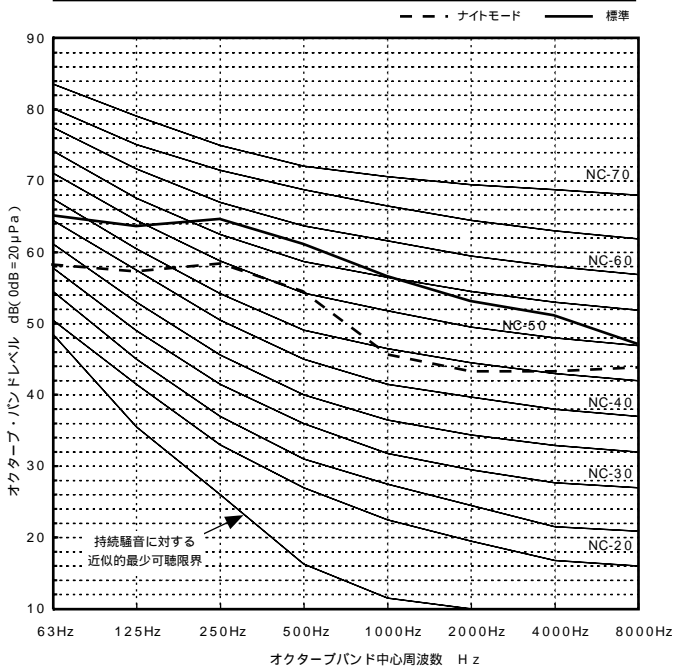

PUHY-P900SM-E(-BS,-BSG)形

	63Hz	125Hz	250Hz	500Hz	1000Hz	2000Hz	4000Hz	8000Hz	A特性(dB)
標準	62.5	65.5	64.5	61	58	55	53.5	50	64
ナイトモード	58	58.5	56	51.5	49	47	48	45	56

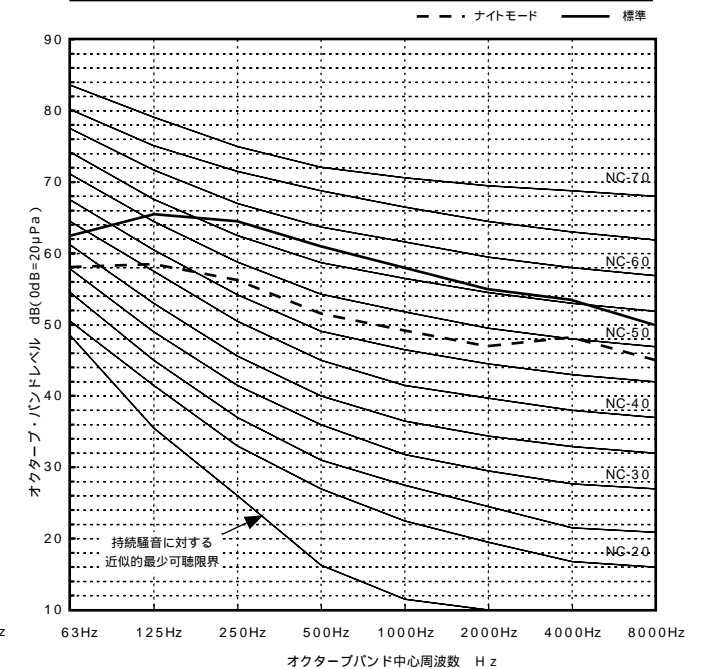

PVHN-P100SM-E(-BS,-BSG)形

	63Hz	125Hz	250Hz	500Hz	1000Hz	2000Hz	4000Hz	8000Hz	A特性(dB)	
標準	50/60Hz	61	55.5	57.5	55.5	51	48	42	34	57

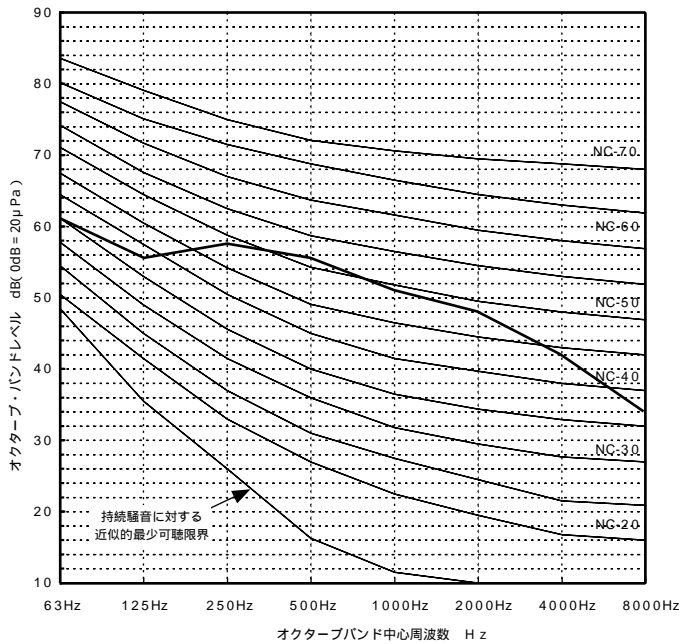

PUHY-P684SM-E(-BS,-BSG)形

	63Hz	125Hz	250Hz	500Hz	1000Hz	2000Hz	4000Hz	8000Hz	A特性(dB)	
標準	50/60Hz	62.5	62	61.5	59	53.5	50.5	50	43.5	60.5

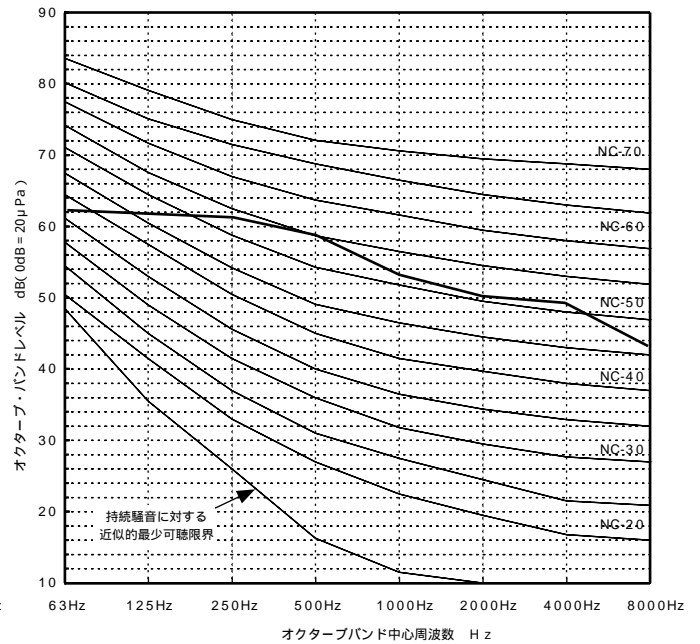

PUHY-P740SM-E(-BS,-BSG)形

	63Hz	125Hz	250Hz	500Hz	1000Hz	2000Hz	4000Hz	8000Hz	A特性(dB)	
標準	50/60Hz	62.5	63	63.5	60	55.5	52	50	46.5	62

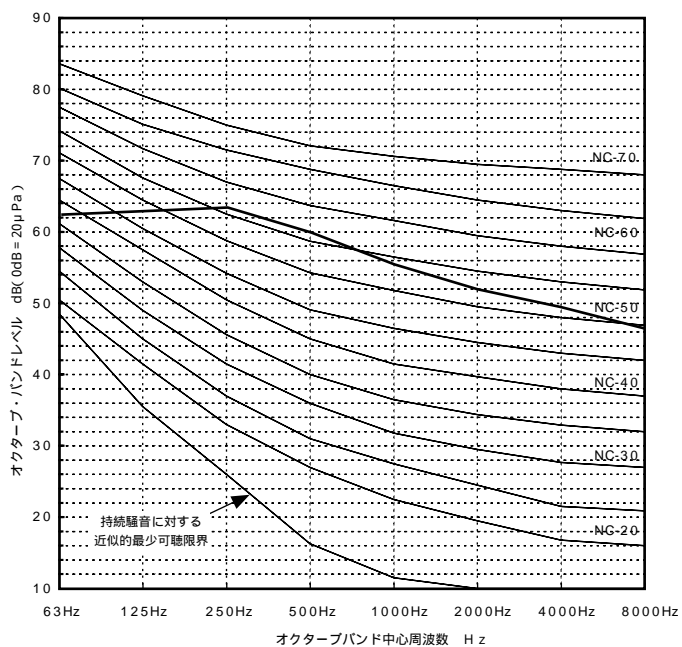

PUHY-P800SM-E(-BS,-BSG)形

	63Hz	125Hz	250Hz	500Hz	1000Hz	2000Hz	4000Hz	8000Hz	A特性(dB)	
標準	50/60Hz	62.5	65.5	63	60	56.5	54	54	50.5	63

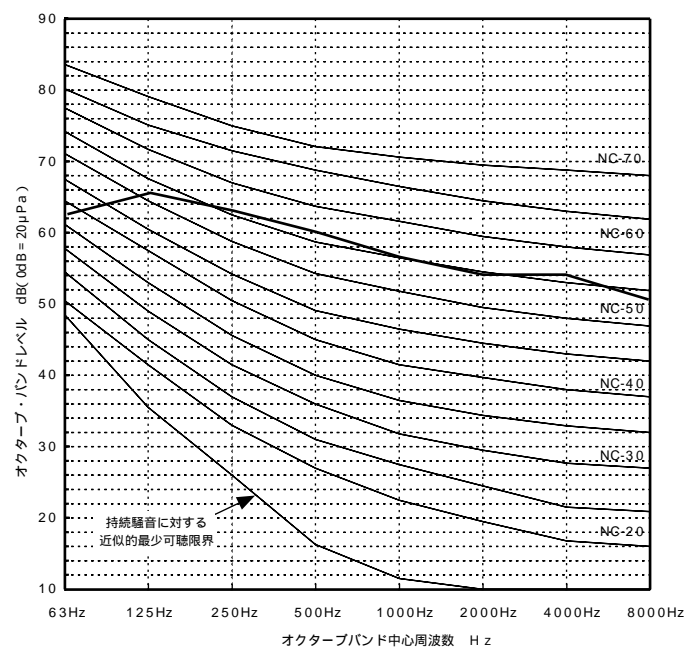

### PUHY-P960SKM-E(-BS,-BSG)形

		63Hz	125Hz	250Hz	500Hz	1000Hz	2000Hz	4000Hz	8000Hz	A特性 dB	
標準	50Hz	70	66	64	61.5	56.5	53.5	49	44.5	63	
	60Hz	73.5	67.5	64	62.5	57.5	54	50	44	64	
ナイトモード		50/60Hz	65	64	55	54.5	49.5	44	39.5	42.5	56

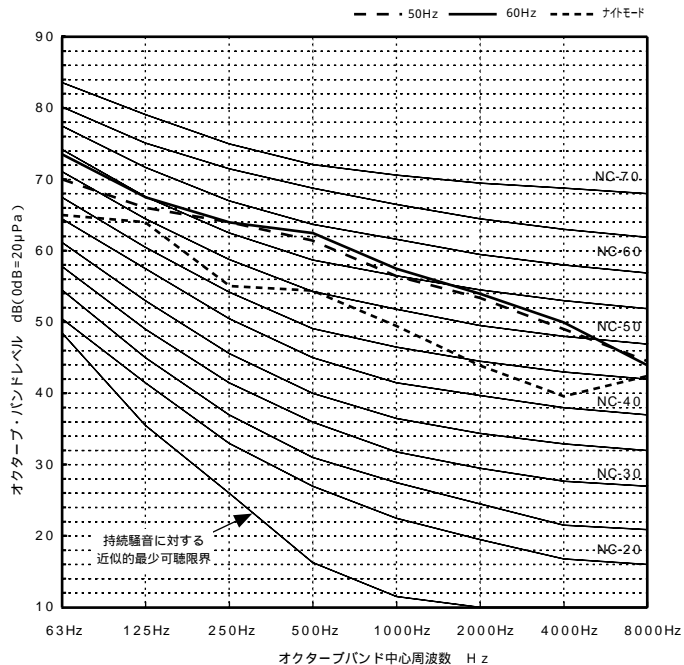

### PUHY-P1010SKM-E(-BS,-BSG)形

		63Hz	125Hz	250Hz	500Hz	1000Hz	2000Hz	4000Hz	8000Hz	A特性 dB	
標準	50Hz	70	65	63.5	61	57	54	50.5	45.5	63	
	60Hz	72.5	68	64	62.5	57.5	54.5	51.5	45.5	64	
ナイトモード		50/60Hz	64	61	55	55	49	46	41	42	56

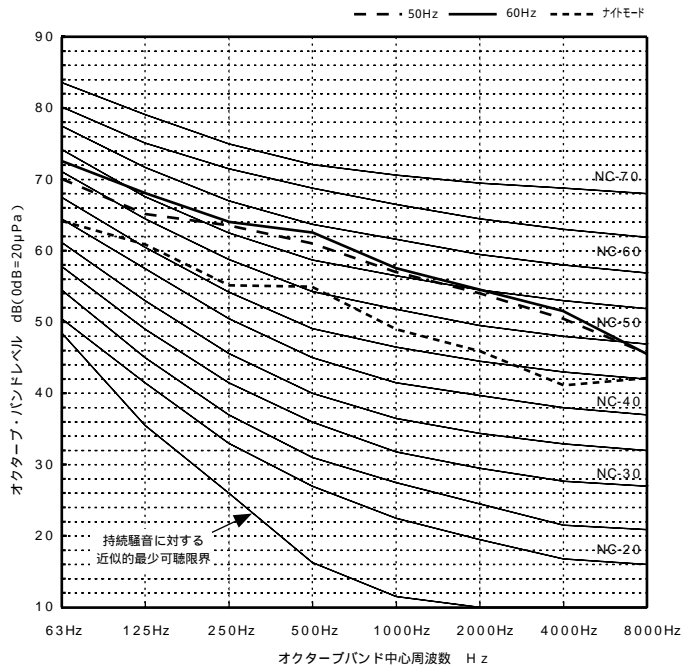

### PUHY-P1080SKM-E(-BS,-BSG)形

		63Hz	125Hz	250Hz	500Hz	1000Hz	2000Hz	4000Hz	8000Hz	A特性 dB	
標準	50Hz	69.5	64.5	64	61	56.5	54	51	45.5	63	
	60Hz	72	67.5	64	62.5	57.5	54	52.5	47	64	
ナイトモード		50/60Hz	64	62	55.5	56	49	47.5	43	41.5	57

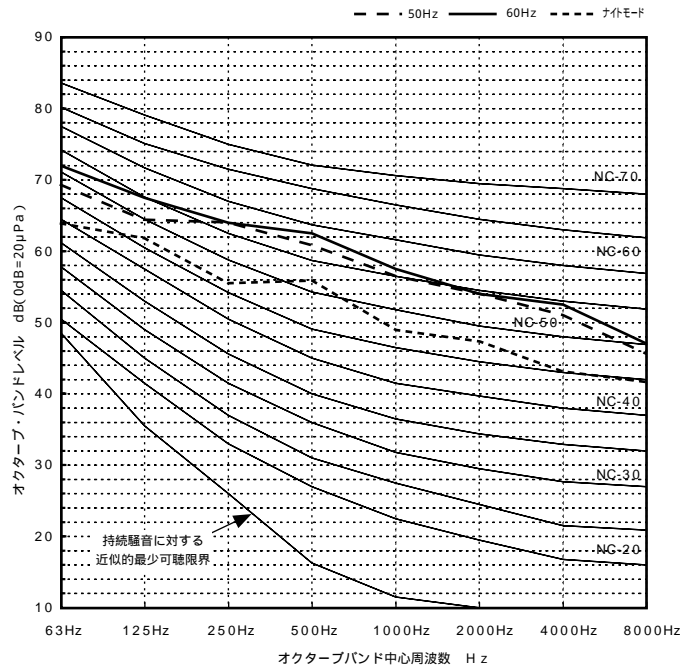

### PUHY-P1130SKM-E(-BS,-BSG)形

		63Hz	125Hz	250Hz	500Hz	1000Hz	2000Hz	4000Hz	8000Hz	A特性 dB	
標準	50Hz	70.5	67.5	64	60.5	56	54	52	47	63	
	60Hz	71.5	68.5	65	62	57	54.5	52.5	47.5	64	
ナイトモード		50/60Hz	64.5	62.5	56	55	51	47	44	42	57

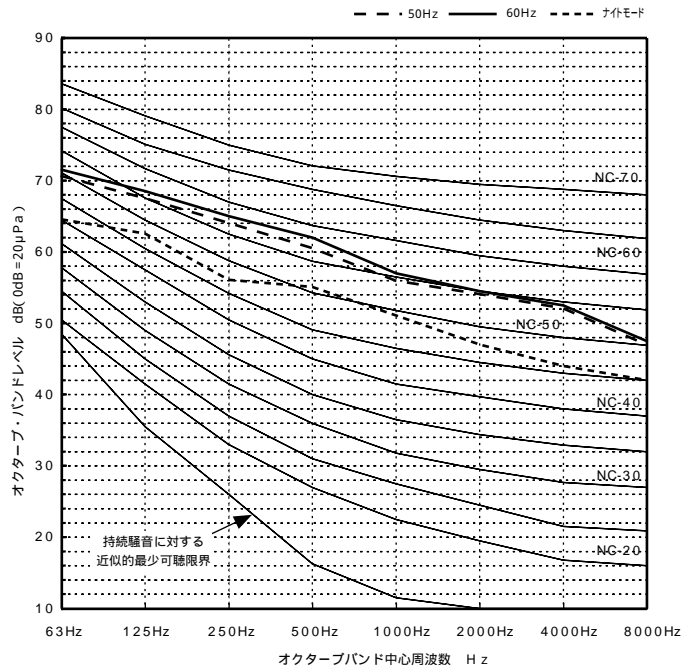

PUHY-P1180SKM-E(-BS,-BSG)形

		63Hz	125Hz	250Hz	500Hz	1000Hz	2000Hz	4000Hz	8000Hz	A特性(dB)	
標準	50Hz	71	65.5	63.5	61.5	56.5	54	54	48	63.5	
	60Hz	71.5	68.5	64.5	62	57.5	55	55	49.5	64.5	
ナイトモード		50/60Hz	64.5	62.5	57	56	49	45	45	42.5	57

--- 50Hz    — 60Hz    - - - ナイトモード

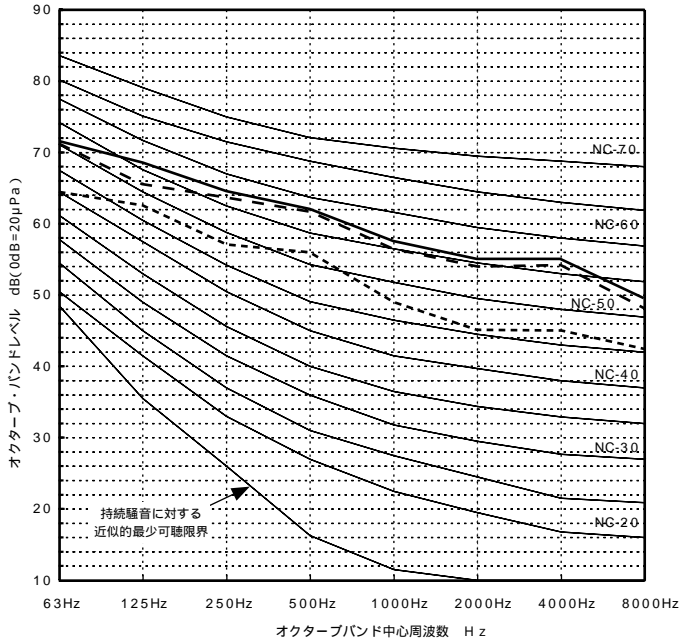

PUHY-P1240SKM-E(-BS,-BSG)形

		63Hz	125Hz	250Hz	500Hz	1000Hz	2000Hz	4000Hz	8000Hz	A特性(dB)	
標準	50Hz	71.5	65.5	64	62	57	54.5	54.5	48.5	64	
	60Hz	72	69	64.5	62.5	58	55.5	56	50	65	
ナイトモード		50/60Hz	64.5	62	57	56	49	45	45	42	57

--- 50Hz    — 60Hz    - - - ナイトモード

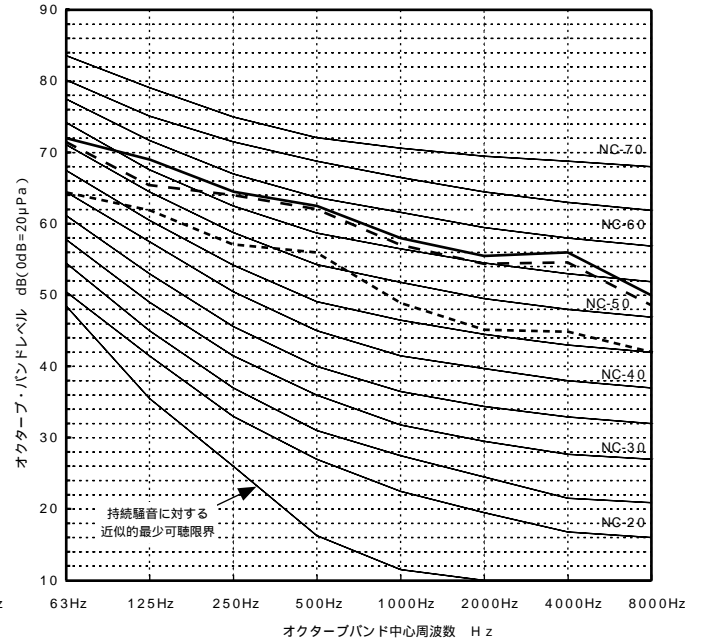

PUHY-P1300SKM-E(-BS,-BSG)形

		63Hz	125Hz	250Hz	500Hz	1000Hz	2000Hz	4000Hz	8000Hz	A特性(dB)	
標準	50Hz	71.5	65.5	64	62	57	54.5	54.5	48.5	64	
	60Hz	70	69.5	64.5	62.5	58	55.5	56	51	65	
ナイトモード		50/60Hz	63	59	56.5	56.5	48	47.5	46	41	57

--- 50Hz    — 60Hz    - - - ナイトモード

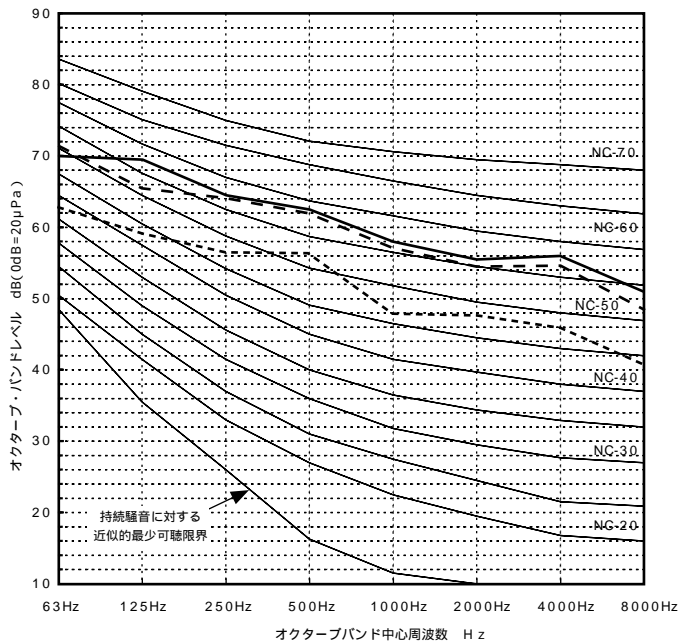

PUHY-P1360SKM-E(-BS,-BSG)形

		63Hz	125Hz	250Hz	500Hz	1000Hz	2000Hz	4000Hz	8000Hz	A特性(dB)	
標準	50Hz	70.5	64.5	64.5	61.5	57	55	54.5	48	64	
	60Hz	69	69.5	65	62.5	58	55	56	51	65	
ナイトモード		50/60Hz	63	59	56.5	56.5	48	47.5	46	41	57

--- 50Hz    — 60Hz    - - - ナイトモード

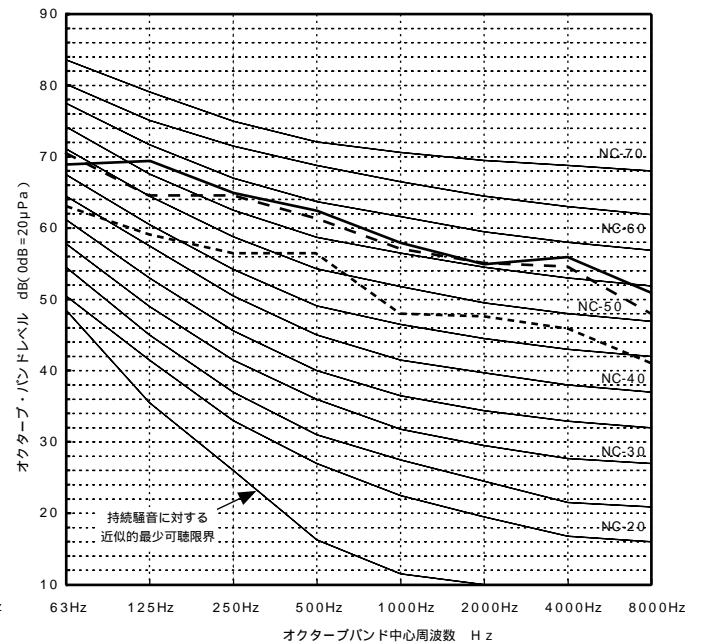



### PUHY-P1400SKM-E(-BS,-BSG)形

標準	50Hz	63Hz	125Hz	250Hz	500Hz	1000Hz	2000Hz	4000Hz	8000Hz	A特性 dB
		60Hz	73	69	65.5	62.5	57.5	55.5	56	50
ナイトモード	50/60Hz	64	60	57.5	56.5	51	48	47	42	58

---・50Hz ———60Hz - - - - ナイトモード

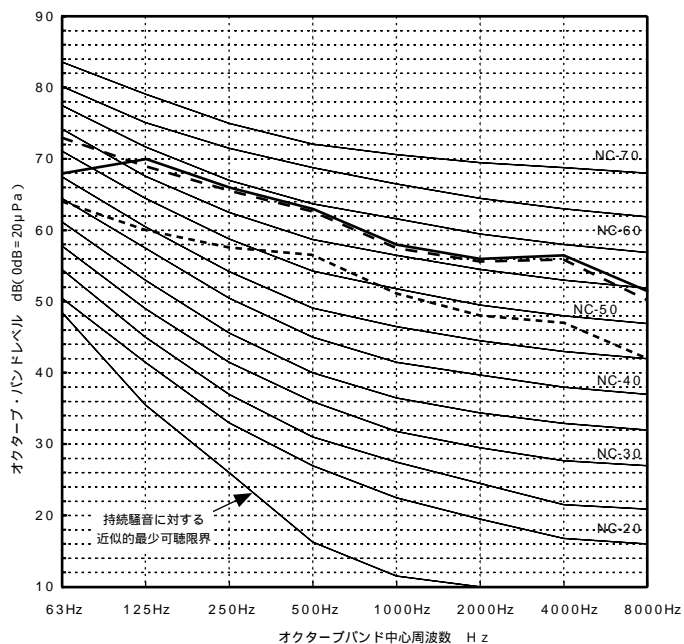

### PUHY-P500SM-E(-BS,-BSG)形

標準	50Hz	63Hz	125Hz	250Hz	500Hz	1000Hz	2000Hz	4000Hz	8000Hz	A特性 dB
		60Hz	67.5	63.5	61.5	59	53.5	51.5	47	42.5
ナイトモード	50/60Hz	62.5	61	62.5	52	47.5	41.5	37	40	54

---・50Hz ———60Hz - - - - ナイトモード

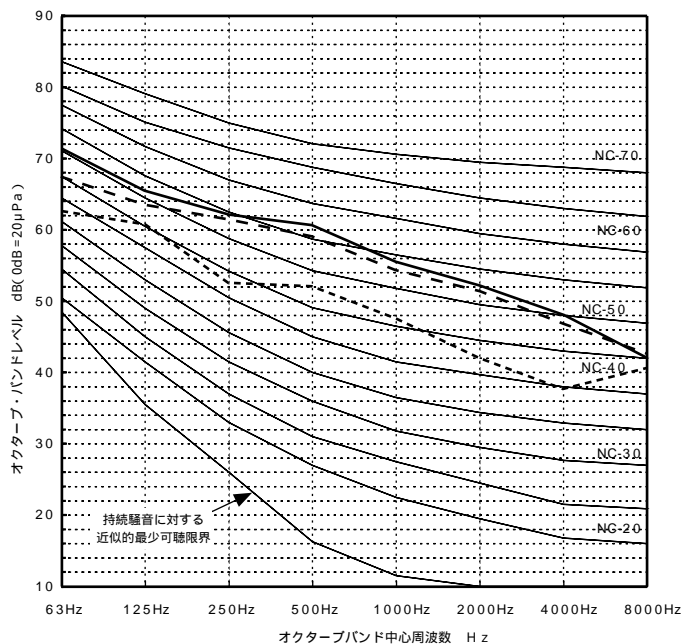

### PUHY-P560SM-E(-BS,-BSG)形

標準	50Hz	63Hz	125Hz	250Hz	500Hz	1000Hz	2000Hz	4000Hz	8000Hz	A特性 dB
		60Hz	68	62.5	61.5	59	54.5	51.5	49	44
ナイトモード	50/60Hz	61	53.5	53	53.5	46	43.5	39.5	39	54

---・50Hz ———60Hz - - - - ナイトモード

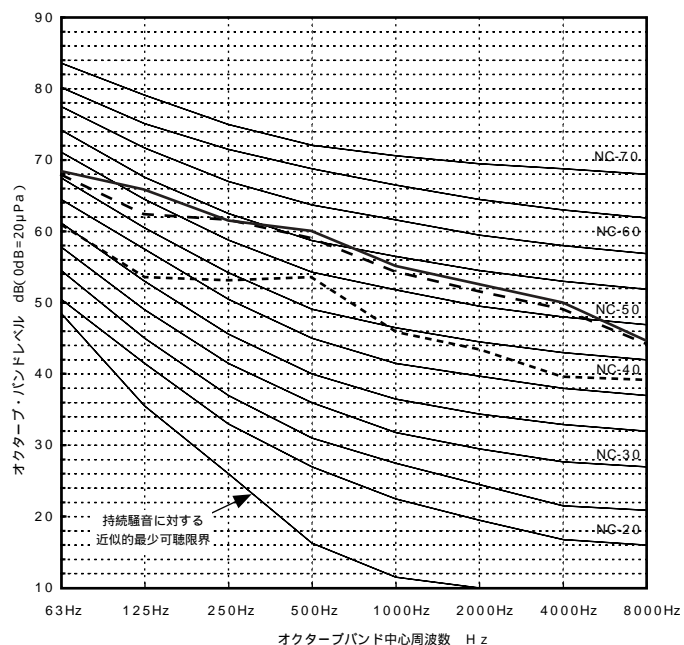

### PUHY-P630SM-E(-BS,-BSG)形

標準	50Hz	63Hz	125Hz	250Hz	500Hz	1000Hz	2000Hz	4000Hz	8000Hz	A特性 dB
		60Hz	67	61	62	59	54	52.5	49.5	44
ナイトモード	50/60Hz	58.5	54.5	51.5	53.5	44.5	45.5	41	35.5	54

---・50Hz ———60Hz - - - - ナイトモード

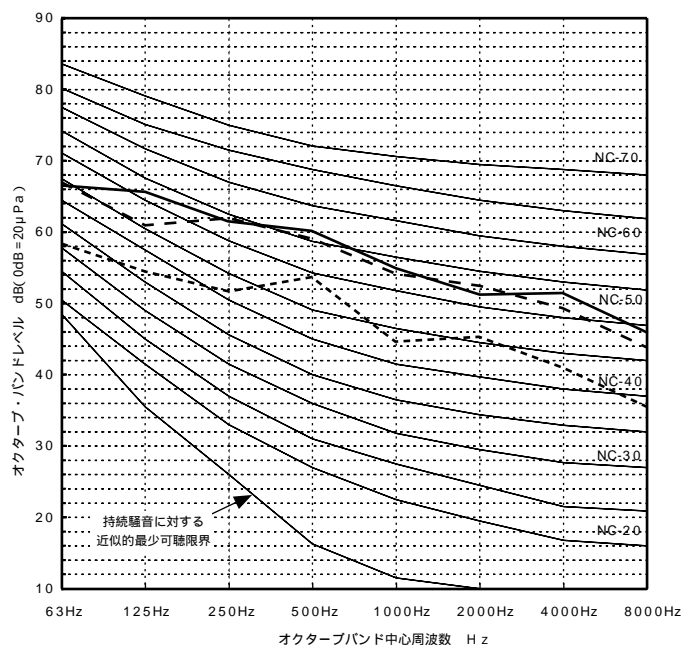

PUHY-P670SM-E (-BS,-BSG)形

		63Hz	125Hz	250Hz	500Hz	1000Hz	2000Hz	4000Hz	8000Hz	A特性 (dB)	
標準	50Hz	70	67.5	63	59	54.5	52.5	52	47	62	
	60Hz	66	67.5	64	60	55	53	52	47	62.5	
ナイトモード		50/60Hz	59.5	55.5	51	52	48	44.5	42.5	37.5	54

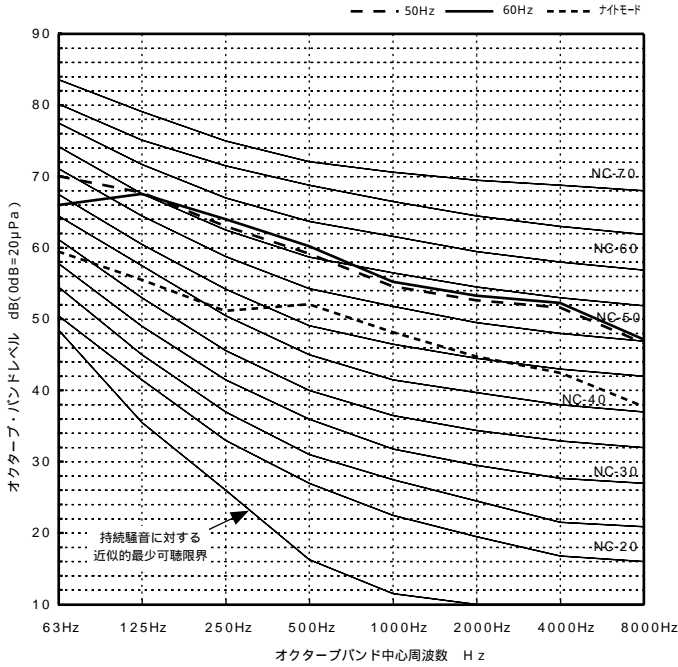

PUHY-P730SM-E (-BS,-BSG)形

		63Hz	125Hz	250Hz	500Hz	1000Hz	2000Hz	4000Hz	8000Hz	A特性 (dB)	
標準	50Hz	69.5	63	61.5	59.5	54.5	52.5	54	47	62	
	60Hz	65	67	62	59.5	55	53	54.5	49	62.5	
ナイトモード		50/60Hz	60.5	55.5	54.5	53	44.5	42	43.5	38.5	54

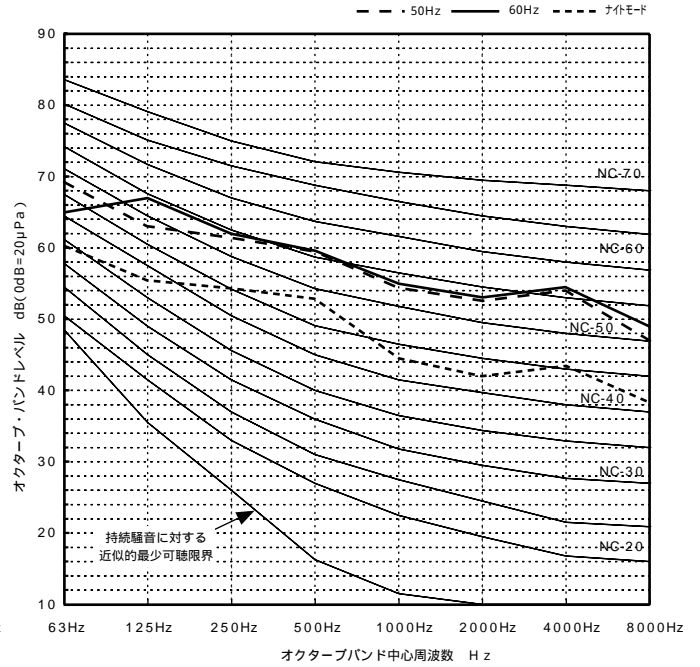

PUHY-P450KM-E (-BS,-BSG)形

		63Hz	125Hz	250Hz	500Hz	1000Hz	2000Hz	4000Hz	8000Hz	A特性 (dB)	
標準	50Hz	67.5	63.5	61.5	59	54	51	46.5	42	60.5	
	60Hz	71.5	65.5	62	60	55	51.5	47.5	41.5	61.5	
ナイトモード		50/60Hz	62.5	61	52.5	52	47.5	42	36.5	39.5	53.5

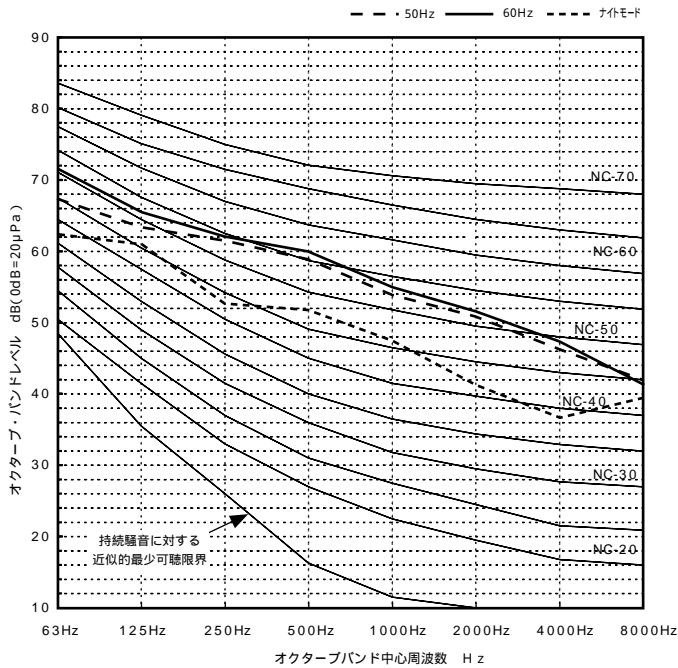

PUHY-P730KM-E (-BS,-BSG)形

		63Hz	125Hz	250Hz	500Hz	1000Hz	2000Hz	4000Hz	8000Hz	A特性 (dB)	
標準	50Hz	69.5	63	61.5	59.5	54.5	52.5	54	47	62	
	60Hz	65	67	62	59.5	55	53	54.5	49	62.5	
ナイトモード		50/60Hz	60.5	55.5	54.5	53	44.5	42	43.5	38.5	54

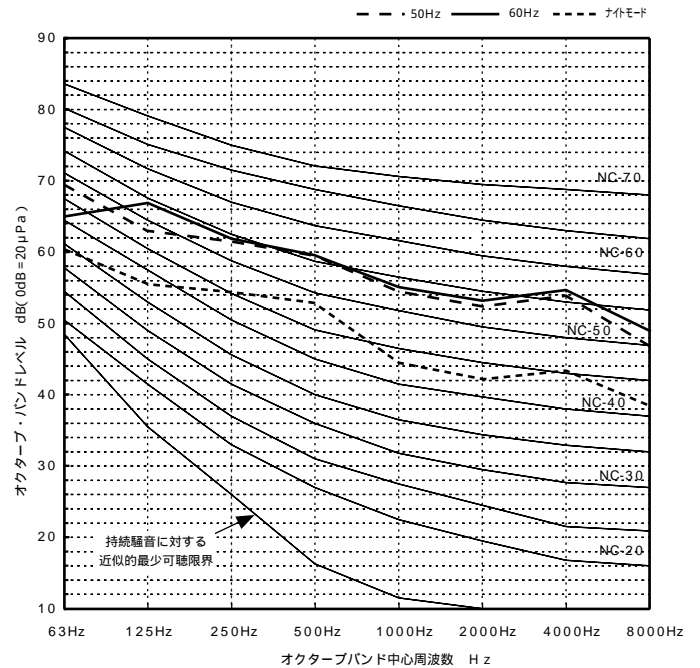

### 3. 送風機特性線図

#### (1) ビルトインカセット形

PDFY-P22・28・36M-E1

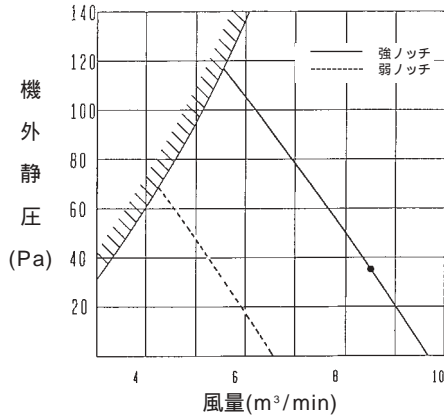

PDFY-P45・56M-E1

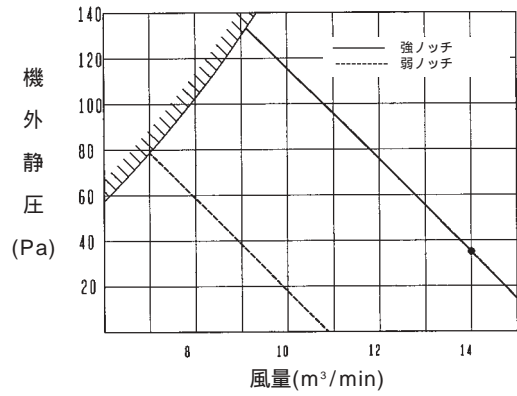

PDFY-P71M-E1

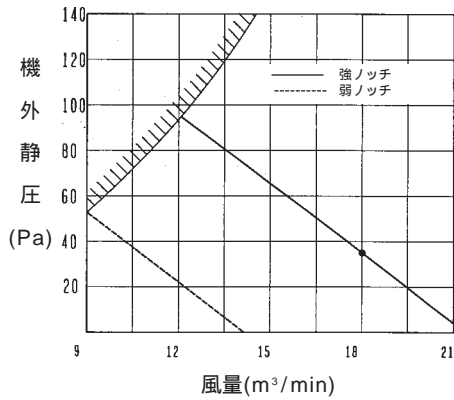

PDFY-P80M-E1

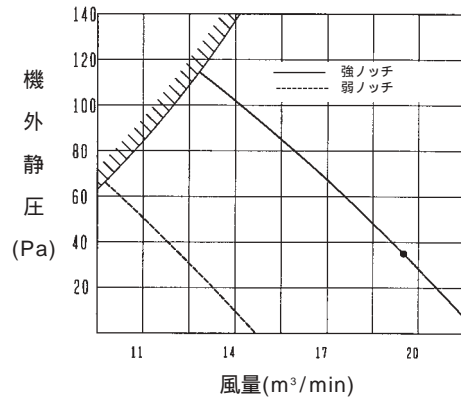

PDFY-P90M-E1

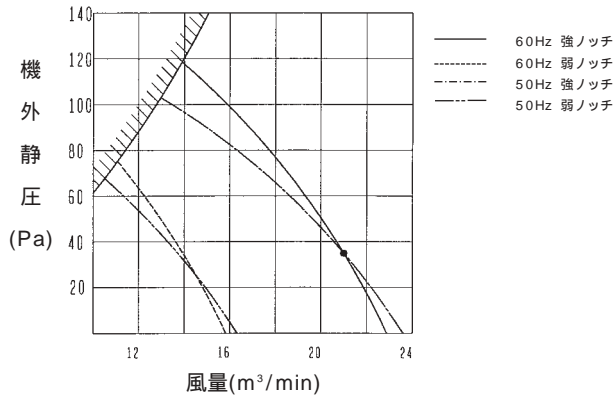

PDFY-P112M-E1

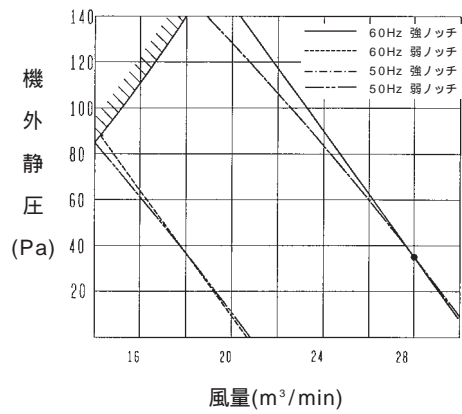

PDFY-P140M-E1

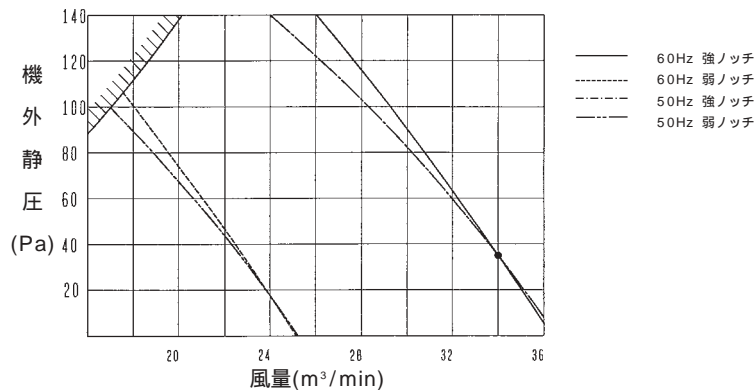

(2) 天井埋込形

PEFY-P45・56M-E1

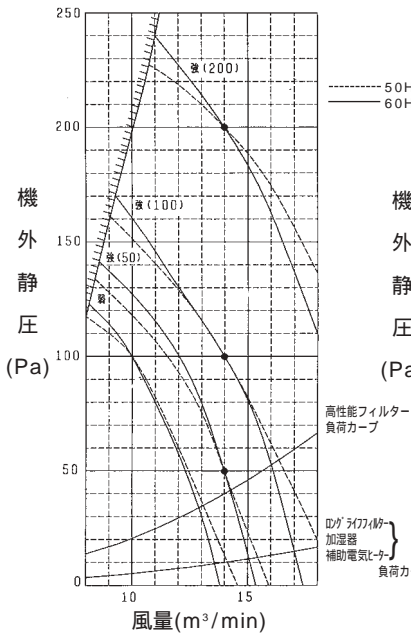

PEFY-P71M-E1

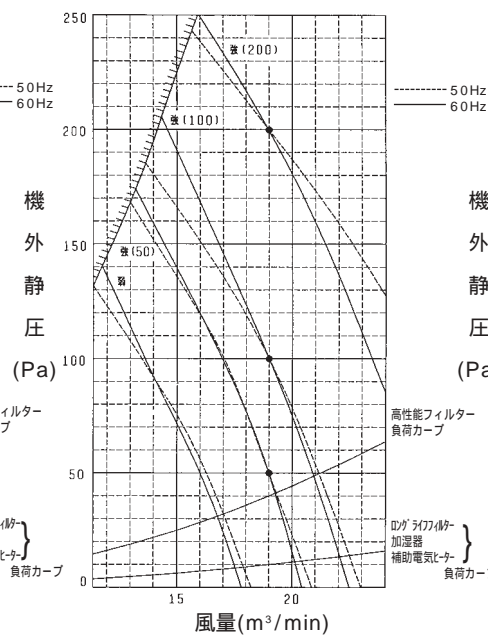

PEFY-P80M-E1

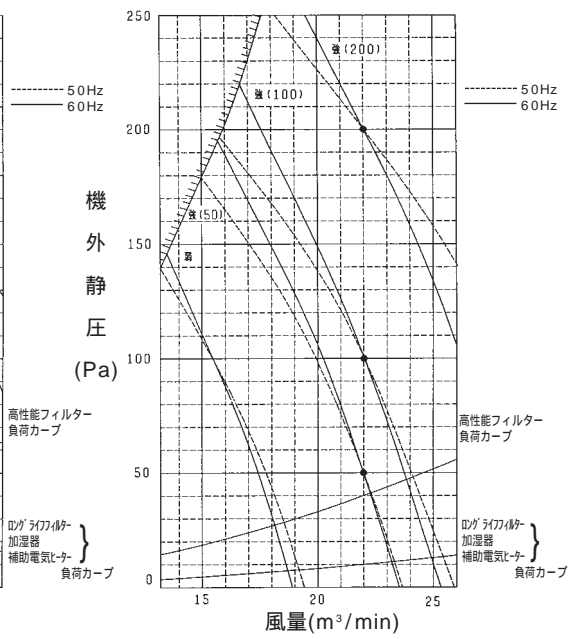

PEFY-P90M-E1

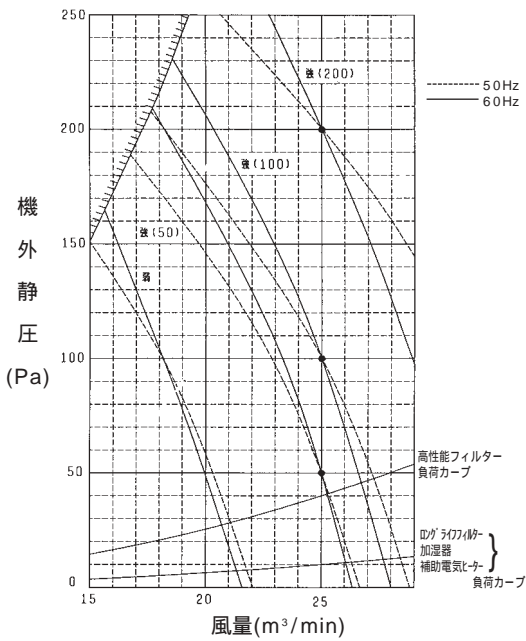

PEFY-P112・140M-E1

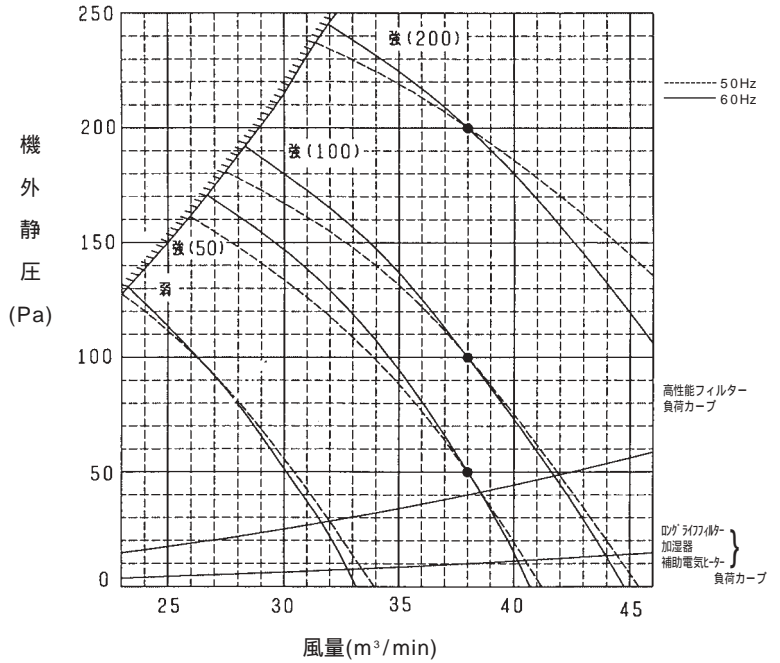

PEFY-P160M-E1

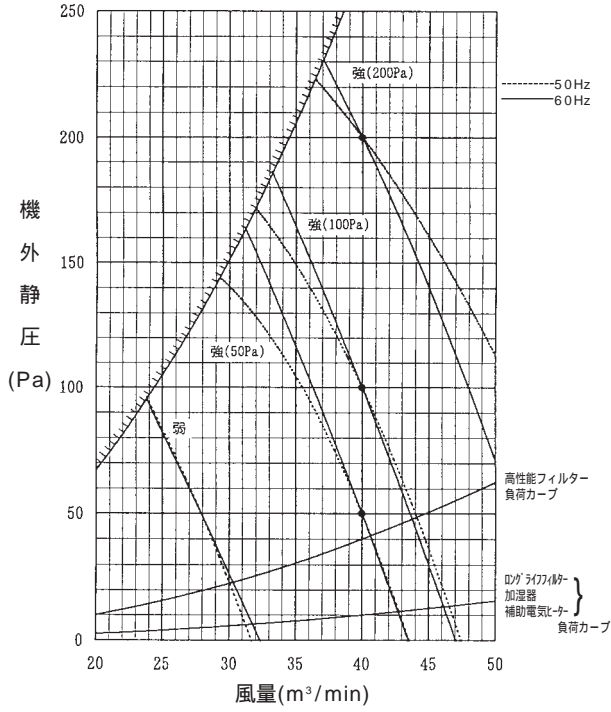

PEFY-P224M-E1

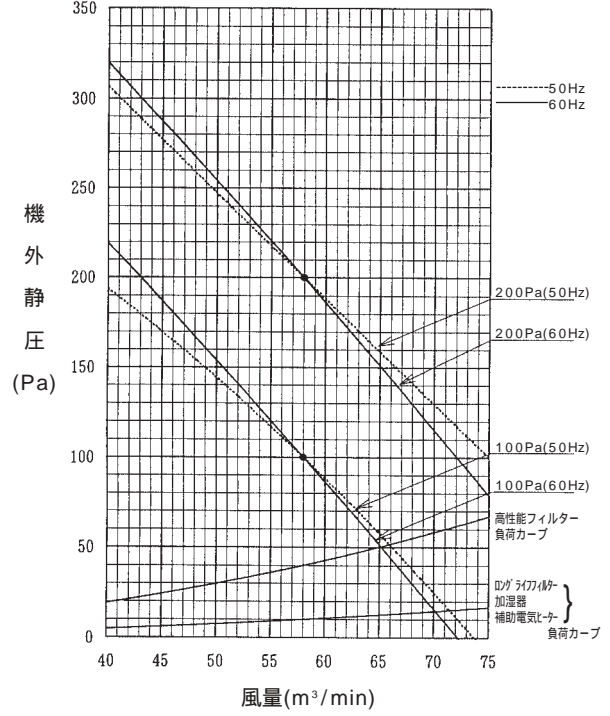

PEFY-P280M-E1

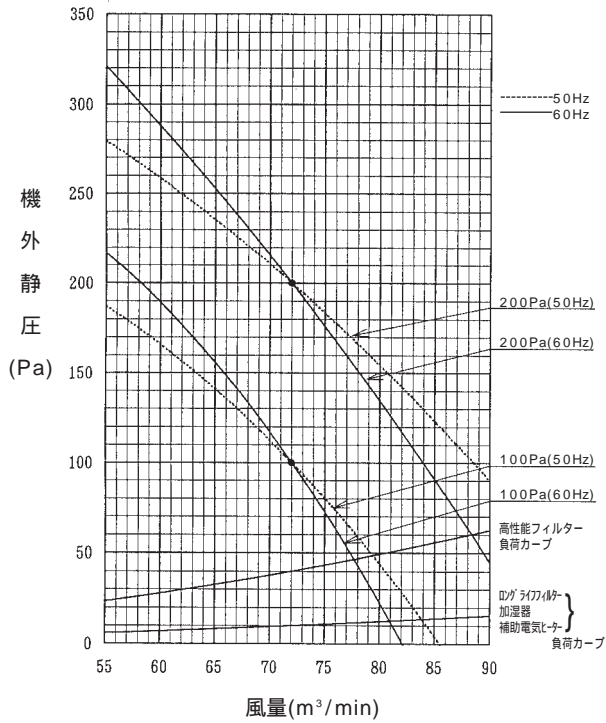

(3) 床置形  
PFFY-P224DM-E1

50Hz

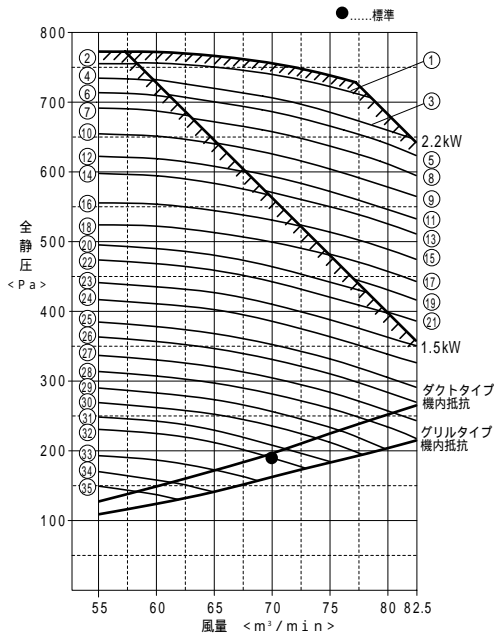

標準点は、モーターブリー径(可変ブリー)を 140(出荷時は 116.7)に調整した値を示します。  
①～⑳ は静風圧部品選定表の組合せ を示します。

標準仕様

電動機	モーターブリー	ファンブリー	Vベルト	51F設定値
1.5kW全閉形	A可変24 (出荷時PC 116.7)	A224-20	A56	6.5A

No.	回転数 (rpm)	モーター1.5kW (標準) 用 A1 (A形1本掛け) レッドラベル		V ベルト	モーター2.2kW (別売PAC-CJ64MR) 用 A1 (A形1本掛け) レッドラベル		V ベルト	
		モーターブリー 形名	ファンブリー 形名		モーターブリー 形名	ファンブリー 形名		
1677	標準	3/4	PAC-CT02SP( 118)	49	PAC-CT10MP	2・3/4	PAC-CT02SP( 118)	50
1675	標準	3/4	PAC-CT02SP( 118)	49	PAC-CT10MP	3・1/4	PAC-CT02SP( 118)	50
1648	標準	1・1/4	PAC-CT02SP( 118)	49	PAC-CT10MP	1/2	PAC-CT03SP( 132)	51
1645	標準	1・1/4	PAC-CT02SP( 118)	49	PAC-CT10MP	1・1/4	PAC-CT03SP( 132)	51
1620	標準	2・1/4	PAC-CT02SP( 118)	49	PAC-CT10MP	2	PAC-CT03SP( 132)	51
1615	標準	0	PAC-CT03SP( 132)	50	PAC-CT10MP	2・3/4	PAC-CT03SP( 132)	51
1585	標準	3/4	PAC-CT03SP( 132)	50	PAC-CT10MP	3・1/2	PAC-CT03SP( 132)	51
1581	標準	1・1/2	PAC-CT03SP( 132)	50	PAC-CT10MP	4・1/4	PAC-CT03SP( 132)	51
1540	標準	2・1/4	PAC-CT03SP( 132)	49	PAC-CT10MP	1・1/2	PAC-CT04SP( 150)	52
1538	標準	3	PAC-CT03SP( 132)	49	PAC-CT10MP	2・1/4	PAC-CT04SP( 150)	52
1499	標準	3・3/4	PAC-CT03SP( 132)	49	PAC-CT10MP	3	PAC-CT04SP( 150)	52
1497	標準	1	PAC-CT04SP( 150)	51				
1459	標準	2	PAC-CT04SP( 150)	51				
1457	標準	3	PAC-CT04SP( 150)	51				
1459	標準	4	PAC-CT04SP( 150)	51				
1457	標準	5	PAC-CT04SP( 150)	51				
1418	標準	6	PAC-CT04SP( 150)	51				
1417	標準	7	PAC-CT04SP( 150)	51				
1378	標準	8	PAC-CT04SP( 150)	51				
1376	標準	9	PAC-CT04SP( 150)	51				
1344	標準	10	PAC-CT04SP( 150)	51				
1336	標準	11	PAC-CT04SP( 150)	51				
1308	標準	12	PAC-CT04SP( 150)	51				
1306	標準	13	PAC-CT04SP( 150)	51				
1259	標準	14	PAC-CT04SP( 150)	51				
1223	標準	15	PAC-CT04SP( 150)	51				
1175	標準	16	PAC-CT04SP( 150)	51				
1140	標準	17	PAC-CT04SP( 150)	51				
1098	標準	18	PAC-CT04SP( 150)	51				
1059	標準	19	PAC-CT04SP( 150)	51				
1019	標準	20	PAC-CT04SP( 150)	51				
980	標準	21	PAC-CT04SP( 150)	51				
940	標準	22	PAC-CT04SP( 150)	51				
906	標準	23	標準( 224)	56				
858	標準	24	標準( 224)	56				
819	標準	25	標準( 224)	56				
787	標準	26	標準( 224)	56				

注1. モーターを2.2kWにした場合、51F (過電流継電器) の設定値は9.0Aとなります。

注2. Vベルトは上表に示すサイズの別売部品を手配してください。

Vベルト別売形名一覧表 形名は「PAC-CJ\*\*VB」で、\*\*部を下表の形名欄に示します。

サイズ	44	45	46	47	49	50	51	52	53	54	55	56	58	59
形名	14	15	16	17	49	50	51	52	53	54	55	56	58	59

注3. 標準仕様は機内抵抗165Pa、機外静圧30Pa、風量70m³/minです。

注4. 50Hz地区の場合、上記標準仕様にてご使用される時は、電動機ブリーPC (可変ブリー)を140 (スライドビス回転数: 0) にしてください。

注5. 別売プレナムは機外静圧30Paです。上記3. に示すブリー仕様にてご使用ください。(風量70m³/min)

注6. 機内抵抗はフィルドフィルターなど別売部品を組み込んだ場合に変わりますので補正が必要です。該当する部品の圧損線図を参照の上、補正をしてください。

60Hz

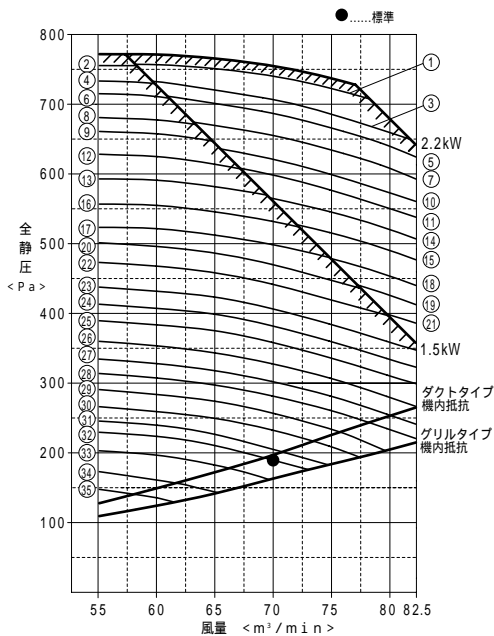

①～⑳ は静風圧部品選定表の組合せ を示します。

標準仕様

電動機	モーターブリー	ファンブリー	Vベルト	51F設定値
1.5kW全閉形	A可変24 (出荷時PC 116.7)	A224-20	A56	6.5A

No.	回転数 (rpm)	モーター1.5kW (標準) 用 A1 (A形1本掛け) レッドラベル		V ベルト	モーター2.2kW (別売PAC-CJ64MR) 用 A1 (A形1本掛け) レッドラベル		V ベルト	
		モーターブリー 形名	ファンブリー 形名		モーターブリー 形名	ファンブリー 形名		
1679	標準	2・3/4	PAC-CT03SP( 132)	49	PAC-CT10MP	1・1/4	PAC-CT04SP( 150)	52
1677	標準	2・3/4	PAC-CT03SP( 132)	49	PAC-CT10MP	1・3/4	PAC-CT04SP( 150)	52
1650	標準	3・1/4	PAC-CT03SP( 132)	49	PAC-CT10MP	2・1/4	PAC-CT04SP( 150)	52
1645	標準	3・1/4	PAC-CT03SP( 132)	49	PAC-CT10MP	3	PAC-CT04SP( 150)	52
1622	標準	4	PAC-CT03SP( 132)	49	PAC-CT10MP	4・1/4	PAC-CT04SP( 150)	52
1619	標準	1/4	PAC-CT04SP( 150)	51	PAC-CT10MP	0	PAC-CT05SP( 180)	54
1579	標準	1/4	PAC-CT04SP( 150)	51	PAC-CT10MP	3/4	PAC-CT05SP( 180)	54
1576	標準	1	PAC-CT04SP( 150)	51				
1547	標準	1・1/2	PAC-CT04SP( 150)	51				
1535	標準	2・1/4	PAC-CT04SP( 150)	51				
1506	標準	3	PAC-CT04SP( 150)	51				
1462	標準	3・3/4	PAC-CT04SP( 150)	51				
1458	標準	4	PAC-CT04SP( 150)	51				
1422	標準	5	PAC-CT04SP( 150)	51				
1419	標準	6	PAC-CT04SP( 150)	51				
1376	標準	7	PAC-CT04SP( 150)	51				
1375	標準	8	PAC-CT04SP( 150)	51				
1339	標準	9	PAC-CT04SP( 150)	51				
1337	標準	10	PAC-CT04SP( 150)	51				
1304	標準	11	PAC-CT04SP( 150)	51				
1302	標準	12	PAC-CT04SP( 150)	51				
1254	標準	13	PAC-CT04SP( 150)	51				
1218	標準	14	PAC-CT04SP( 150)	51				
1182	標準	15	PAC-CT04SP( 150)	51				
1135	標準	16	PAC-CT04SP( 150)	51				
1094	標準	17	標準( 224)	56				
1055	標準	18	標準( 224)	56				
1017	標準	19	標準( 224)	56				
979	標準	20	標準( 224)	56				
941	標準	21	標準( 224)	56				
912	標準	22	標準( 224)	56				
877	標準	23	PAC-CT07SP( 250)	58				
825	標準	24	PAC-CT07SP( 250)	58				
783	標準	25	PAC-CT08SP( 280)	59				

注1. モーターを2.2kWにした場合、51F (過電流継電器) の設定値は9.0Aとなります。

注2. Vベルトは上表に示すサイズの別売部品を手配してください。

Vベルト別売形名一覧表 形名は「PAC-CJ\*\*VB」で、\*\*部を下表の形名欄に示します。

サイズ	44	45	46	47	49	50	51	52	53	54	55	56	58	59
形名	14	15	16	17	49	50	51	52	53	54	55	56	58	59

注3. 標準仕様は機内抵抗165Pa、機外静圧30Pa、風量70m³/minです。

注4. 別売プレナムは機外静圧30Paです。標準仕様のブリーのままご使用ください。(風量70m³/min)

注5. 機内抵抗はフィルドフィルターなど別売部品を組み込んだ場合に変わりますので補正が必要です。該当する部品の圧損線図を参照の上、補正をしてください。

# PFFY-P280DM-E1

50Hz

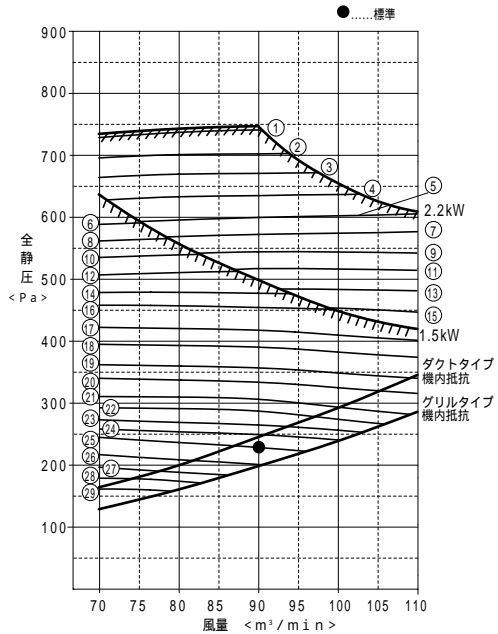

標準点は、モーターブリー径(可変ブリー)を140(出荷時は116.7)に調整した値を示します。  
①-⑳ は静風圧部品選定表の組合せ を示します。

標準仕様

電動機		モーターブリー		ファンブリー	Vベルト	51F設定値		
1.5kW全閉形		A可変24 (出荷時PC 116.7)		A212-20	A55	6.5A		
No.	回転数 (rpm)	モーター1.5kW (標準) 用 A1 (A形1本掛け) レッドラベル			モーター2.2kW (別売PAC-CJ64MR) 用 A1 (A形1本掛け) レッドラベル			
		モーターブリー 形名	ファンブリー スライドビス 回転数	V ベルト	モーターブリー 形名	ファンブリー スライドビス 回転数	V ベルト	
1663					PAC-CT10MP	3	PAC-CT02SP( 118)	50
1620					PAC-CT10MP	1/2	PAC-CT03SP( 132)	51
1581					PAC-CT10MP	1・1/4	PAC-CT03SP( 132)	51
1540					PAC-CT10MP	2	PAC-CT03SP( 132)	51
1499					PAC-CT10MP	2・3/4	PAC-CT03SP( 132)	51
1497		標準	3/4	PAC-CT03SP( 132)	50			
1459					PAC-CT10MP	3・1/2	PAC-CT03SP( 132)	51
1457		標準	1・1/4	PAC-CT03SP( 132)	50			
1418					PAC-CT10MP	4・1/4	PAC-CT03SP( 132)	51
1417		標準	2・1/4	PAC-CT03SP( 132)	49			
1378					PAC-CT10MP	1・1/2	PAC-CT04SP( 150)	52
1376		標準	3	PAC-CT03SP( 132)	49			
1344					PAC-CT10MP	2・1/2	PAC-CT04SP( 150)	52
1336		標準	3・3/4	PAC-CT03SP( 132)	49			
1308					PAC-CT10MP	3	PAC-CT04SP( 150)	52
1306		標準	1	PAC-CT04SP( 150)	51			
1259		標準	2	PAC-CT04SP( 150)	51			
1223		標準	2・3/4	PAC-CT04SP( 150)	51			
1175		標準	3・3/4	PAC-CT04SP( 150)	51			
1140		標準	4・1/2	PAC-CT04SP( 150)	51			
① 1098		標準	3/4	PAC-CT05SP( 180)	53			
② 1059		標準	1・3/4	PAC-CT05SP( 180)	53			
③ 1019		標準	2・3/4	PAC-CT05SP( 180)	53			
④ 989		標準	3・1/2	PAC-CT05SP( 180)	53			
⑤ 958		標準	0	標準( 212)	55			
⑥ 907		標準	1・1/2	標準( 212)	55			
⑦ 865		標準	2・3/4	標準( 212)	55			
⑧ 823		標準	4	標準( 212)	55			
⑨ 787		標準	3・3/4	PAC-CT06SP( 224)	56			

注1. モーターを2.2kWにした場合、51F (過電流継電器) の設定値は9.0Aとなります。  
2. Vベルトは上表に示すサイズの別売部品を手配してください。

Vベルト別売部品一覧表 形名は「PAC-CJ\*\*VB」で、\*\*部を下表の形名欄に示します。

寸径	44	45	46	47	49	50	51	52	53	54	55	56	58	59
形名	14	15	16	17	49	50	51	52	53	54	55	56	58	59

- 標準仕様は機内抵抗200Pa、機外静圧30Pa、風量90m<sup>3</sup>/minです。
- 50Hz地区の場合、上記標準仕様にてご使用される時は、電動機ブリーPC (可変ブリー)を140(スライドビス回転数:0)にしてください。
- 別売プレナムは機外静圧30Paです。上記3. に示すブリー仕様にてご使用ください。(風量90m<sup>3</sup>/min)
- 機内抵抗はフレッドフィルターなど別売部品を組み込んだ場合に変わりますので補正が必要です。
- 該当する部品の圧損線図を参照の上、補正をしてください。

60Hz

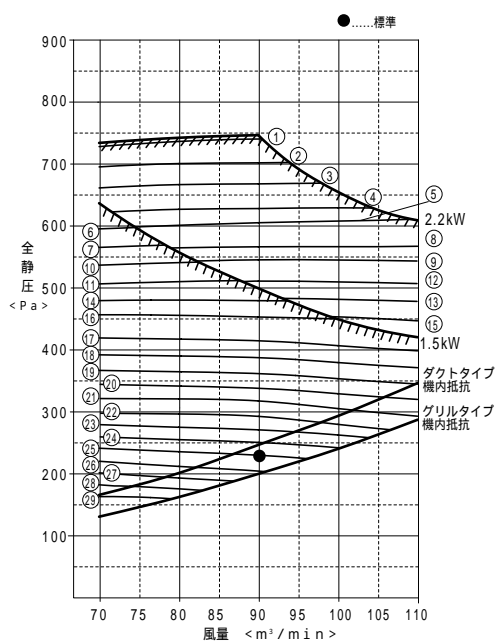

①-⑳ は静風圧部品選定表の組合せ を示します。

標準仕様

電動機		モーターブリー		ファンブリー	Vベルト	51F設定値		
1.5kW全閉形		A可変24 (出荷時PC 116.7)		A212-20	A55	6.5A		
No.	回転数 (rpm)	モーター1.5kW (標準) 用 A1 (A形1本掛け) レッドラベル			モーター2.2kW (別売PAC-CJ64MR) 用 A1 (A形1本掛け) レッドラベル			
		モーターブリー 形名	ファンブリー スライドビス 回転数	V ベルト	モーターブリー 形名	ファンブリー スライドビス 回転数	V ベルト	
1664					PAC-CT10MP	1・1/2	PAC-CT04SP( 150)	52
1622					PAC-CT10MP	2・1/2	PAC-CT04SP( 150)	52
1579					PAC-CT10MP	3	PAC-CT04SP( 150)	52
1535					PAC-CT10MP	3・3/4	PAC-CT04SP( 150)	52
1506					PAC-CT10MP	4・1/4	PAC-CT04SP( 150)	52
1505		標準	2・1/4	PAC-CT04SP( 150)	51			
1462		標準	3	PAC-CT04SP( 150)	51			
1458					PAC-CT10MP	1・1/2	PAC-CT05SP( 180)	54
1422					PAC-CT10MP	3/4	PAC-CT05SP( 180)	54
1419		標準	3・3/4	PAC-CT04SP( 150)	51			
1376		標準	4・1/2	PAC-CT04SP( 150)	51			
1375					PAC-CT10MP	1・3/4	PAC-CT05SP( 180)	54
1339					PAC-CT10MP	2・1/2	PAC-CT05SP( 180)	54
1337		標準	1/2	PAC-CT05SP( 180)	53			
1304					PAC-CT10MP	3・1/4	PAC-CT05SP( 180)	54
1302		標準	1・1/4	PAC-CT05SP( 180)	53			
1254		標準	2・1/4	PAC-CT05SP( 180)	53			
1218		標準	3	PAC-CT05SP( 180)	53			
1182		標準	3・3/4	PAC-CT05SP( 180)	53			
1146		標準	1/4	標準( 212)	55			
① 1105		標準	1・1/4	標準( 212)	55			
② 1065		標準	2・1/4	標準( 212)	55			
③ 1024		標準	3・1/4	標準( 212)	55			
④ 994		標準	4	標準( 212)	55			
⑤ 963		標準	4・3/4	標準( 212)	55			
⑥ 911		標準	2	PAC-CT07SP( 250)	58			
⑦ 877		標準	3	PAC-CT07SP( 250)	58			
⑧ 825		標準	4・1/2	PAC-CT07SP( 250)	58			
⑨ 783		標準	3	PAC-CT08SP( 280)	59			

注1. モーターを2.2kWにした場合、51F (過電流継電器) の設定値は9.0Aとなります。

2. Vベルトは上表に示すサイズの別売部品を手配してください。

Vベルト別売部品一覧表 形名は「PAC-CJ\*\*VB」で、\*\*部を下表の形名欄に示します。

寸径	44	45	46	47	49	50	51	52	53	54	55	56	58	59
形名	14	15	16	17	49	50	51	52	53	54	55	56	58	59

- 標準仕様は機内抵抗200Pa、機外静圧30Pa、風量90m<sup>3</sup>/minです。
- 別売プレナムは機外静圧30Paです。標準仕様のブリーのまますご使用ください。(風量90m<sup>3</sup>/min)
- 機内抵抗はフレッドフィルターなど別売部品を組み込んだ場合に変わりますので補正が必要です。
- 該当する部品の圧損線図を参照の上、補正をしてください。

# PFFY-P450DM-E1

50Hz

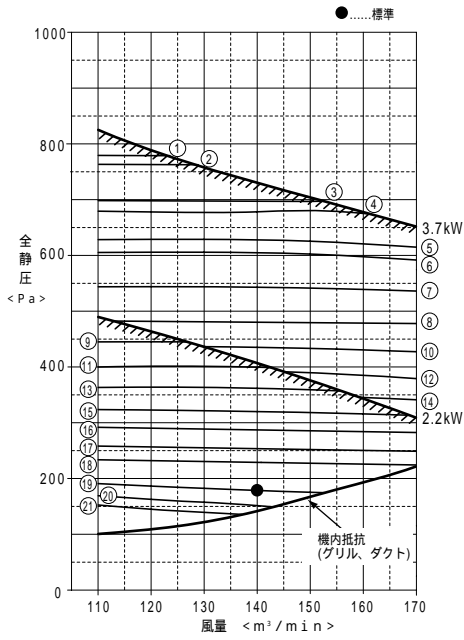

① - ⑳ は静風圧部品選定表の組合せ を示します。

標準仕様

電動機	モーターブリー	ファンブリー	Vベルト	51F設定値
2.2kW全閉形	2B118 - 28	2B280 - 24	B65×2	9.0A

回転数 No. (rpm)	モーター2.2kW (標準) 用 B2 (B形2本掛け) レッドラベル			モーター3.7kW (別売PAC-CJ65MR) 用 B2 (B形2本掛け) レッドラベル		
	モーターブリー 形名	ファンブリー 形名	V ベルト	モーターブリー 形名	ファンブリー 形名	V ベルト
1249				PAC-CH64MP( 155)	PAC-CH42SP( 180)	59
1237				PAC-CH63MP( 145)	PAC-CH41SP( 170)	58
1183				PAC-CH64MP( 155)	PAC-CH43SP( 190)	60
1168				PAC-CH63MP( 145)	PAC-CH42SP( 180)	59
1124				PAC-CH64MP( 155)	PAC-CH44SP( 200)	60
1107				PAC-CH63MP( 145)	PAC-CH43SP( 190)	59
1051				PAC-CH63MP( 145)	PAC-CH44SP( 200)	60
992				PAC-CH63MP( 145)	PAC-CH45SP( 212)	61
951	標準( 118)	PAC-CH42SP( 180)	59			
939				PAC-CH63MP( 145)	PAC-CH46SP( 224)	62
901	標準( 118)	PAC-CH43SP( 190)	59			
891				PAC-CH63MP( 145)	PAC-CH47SP( 236)	62
856	標準( 118)	PAC-CH44SP( 200)	60			
841				PAC-CH63MP( 145)	PAC-CH39SP( 250)	63
807	標準( 118)	PAC-CH45SP( 212)	61			
764	標準( 118)	PAC-CH46SP( 224)	62			
725	標準( 118)	PAC-CH47SP( 236)	62			
684	標準( 118)	PAC-CH39SP( 250)	63			
611	標準( 118)	標準( 280)	65			
570	標準( 118)	PAC-CH49SP( 300)	66			
⑳ 543	標準( 118)	PAC-CH50SP( 315)	67			

- 注1. モーターを3.7kWにした場合、51F (過電流継電器) の設定値は15Aとなります。  
 注2. Vベルトは、モーターブリー、またはファンブリーに付属しています。  
 注3. 標準仕様は機内抵抗140Pa、機外静圧30Pa、風量140m<sup>3</sup>/minです。  
 注4. 別売プレナムは機外静圧30Paです。標準仕様のブリーのまご使用ください。(風量140m<sup>3</sup>/min)  
 注5. 機内抵抗はフレンドフィルターなど別売部品を組込んだ場合に変わりますので補正が必要です。該当する部品の圧損線図を参照の上、補正をしてください。

60Hz

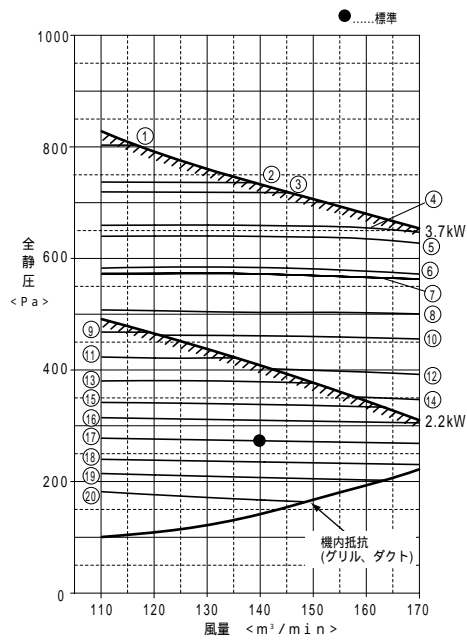

① - ㉔ は静風圧部品選定表の組合せ を示します。

標準仕様

電動機	モーターブリー	ファンブリー	Vベルト	51F設定値
2.2kW全閉形	2B118 - 28	2B280 - 24	B65×2	9.0A

回転数 No. (rpm)	モーター2.2kW (標準) 用 B2 (B形2本掛け) レッドラベル			モーター3.7kW (別売PAC-CJ65MR) 用 B2 (B形2本掛け) レッドラベル		
	モーターブリー 形名	ファンブリー 形名	V ベルト	モーターブリー 形名	ファンブリー 形名	V ベルト
1269				PAC-CH63MP( 145)	PAC-CH44SP( 200)	60
1211				PAC-CH64MP( 155)	PAC-CH46SP( 224)	62
1197				PAC-CH63MP( 145)	PAC-CH45SP( 212)	61
1149				PAC-CH64MP( 155)	PAC-CH47SP( 236)	64
1133				PAC-CH63MP( 145)	PAC-CH46SP( 224)	62
1085				PAC-CH64MP( 155)	PAC-CH39SP( 250)	64
1075				PAC-CH63MP( 145)	PAC-CH47SP( 236)	62
1015				PAC-CH63MP( 145)	PAC-CH39SP( 250)	63
974	標準( 118)	PAC-CH45SP( 212)	61			
969				PAC-CH64MP( 155)	標準( 280)	66
922	標準( 118)	PAC-CH46SP( 224)	62			
906				PAC-CH63MP( 145)	標準( 280)	65
875	標準( 118)	PAC-CH47SP( 236)	62			
846				PAC-CH63MP( 145)	PAC-CH49SP( 300)	66
826	標準( 118)	PAC-CH39SP( 250)	63			
781	PAC-CH62MP( 125)	標準( 280)	65			
738	標準( 118)	標準( 280)	65			
688	標準( 118)	PAC-CH49SP( 300)	66			
656	標準( 118)	PAC-CH50SP( 315)	67			
582	標準( 118)	PAC-CH51SP( 355)	70			

- 注1. モーターを3.7kWにした場合、51F (過電流継電器) の設定値は15Aとなります。  
 注2. Vベルトは、モーターブリー、またはファンブリーに付属しています。  
 注3. 標準仕様は機内抵抗140Pa、機外静圧130Pa、風量140m<sup>3</sup>/minです。  
 注4. 別売プレナムは機外静圧30Paです。上表 のブリー仕様でご使用ください。(風量140m<sup>3</sup>/min)  
 注5. 機内抵抗はフレンドフィルターなど別売部品を組込んだ場合に変わりますので補正が必要です。該当する部品の圧損線図を参照の上、補正をしてください。



# PFFY-P560DM-E1

50Hz

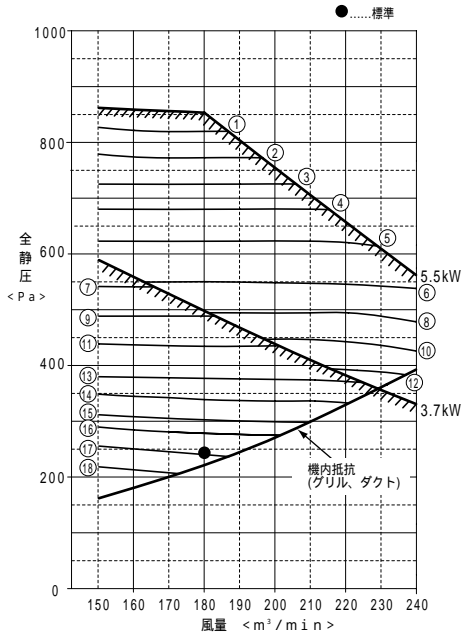

標準仕様

電動機	モーターブリー	ファンブリー	Vベルト	51F設定値
3.7kW全閉形	2B135-28	2B280-28	B64×2	15A

回転数 (rpm)	モーター3.7kW (標準) 用 B2 (B形2本掛け) レッドラベル			モーター5.5kW (別売PAC-CJ66MR) 用 B2 (B形2本掛け) レッドラベル		
	モーターブリー 形名	ファンブリー 形名	V ベルト	モーターブリー 形名	ファンブリー 形名	V ベルト
1274				PAC-CH65MP( 145)	PAC-CH52SP( 165)	56
1237				PAC-CH65MP( 145)	PAC-CH53SP( 170)	56
1196				PAC-CH67MP( 165)	PAC-CH55SP( 200)	59
1168				PAC-CH65MP( 145)	PAC-CH54SP( 180)	57
1124				PAC-CH66MP( 155)	PAC-CH55SP( 200)	59
1060				PAC-CH66MP( 155)	PAC-CH56SP( 212)	60
1051	PAC-CH63MP( 145)	PAC-CH55SP( 200)	60			
1003				PAC-CH66MP( 155)	PAC-CH57SP( 224)	60
992	PAC-CH63MP( 145)	PAC-CH56SP( 212)	60			
952				PAC-CH66MP( 155)	PAC-CH58SP( 236)	61
939	PAC-CH63MP( 145)	PAC-CH57SP( 224)	61			
899				PAC-CH66MP( 155)	PAC-CH40SP( 250)	62
874	標準( 135)	PAC-CH57SP( 224)	61			
829	標準( 135)	PAC-CH58SP( 236)	61			
783	標準( 135)	PAC-CH40SP( 250)	62			
751	PAC-CH63MP( 145)	標準( 280)	65			
699	標準( 135)	標準( 280)	64			
653	標準( 135)	PAC-CH60SP( 300)	66			

- 注1. モーターを5.5kWにした場合、51F (過電流継電器) の設定値は22.5Aとなります。  
 2. Vベルトは、モーターブリー、またはファンブリーに付属しています。  
 3. 標準仕様は機内抵抗220Pa、機外静圧30Pa、風量180m<sup>3</sup>/minです。  
 4. 別売プレナムは機外静圧30Paです。標準仕様のブリーのままご使用ください。(風量180m<sup>3</sup>/min)  
 5. 機内抵抗はフレッドフィルターなど別売部品を組み込んだ場合に変わりますので補正が必要です。該当する部品の圧損線図を参照の上、補正をしてください。

60Hz

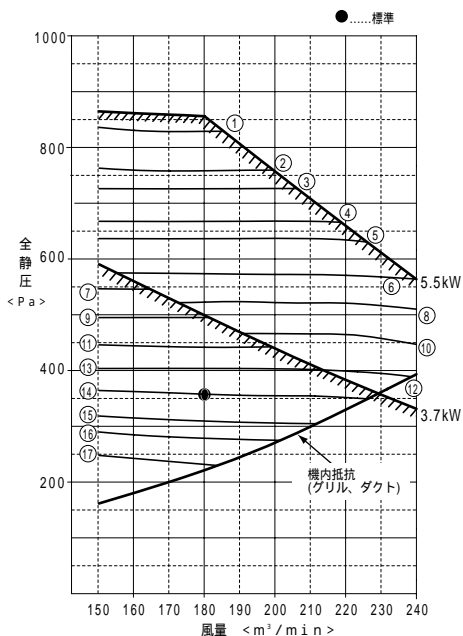

標準仕様

電動機	モーターブリー	ファンブリー	Vベルト	51F設定値
3.7kW全閉形	2B135-28	2B280-28	B64×2	15A

回転数 (rpm)	モーター3.7kW (標準) 用 B2 (B形2本掛け) レッドラベル			モーター5.5kW (別売PAC-CJ66MR) 用 B2 (B形2本掛け) レッドラベル		
	モーターブリー 形名	ファンブリー 形名	V ベルト	モーターブリー 形名	ファンブリー 形名	V ベルト
1279				PAC-CH66MP( 155)	PAC-CH56SP( 212)	60
1224				PAC-CH67MP( 165)	PAC-CH58SP( 236)	62
1197				PAC-CH65MP( 145)	PAC-CH56SP( 212)	59
1155				PAC-CH67MP( 165)	PAC-CH40SP( 250)	63
1133				PAC-CH65MP( 145)	PAC-CH57SP( 224)	60
1085				PAC-CH66MP( 155)	PAC-CH40SP( 250)	62
1055	標準( 135)	PAC-CH57SP( 224)	60			
1031				PAC-CH67MP( 165)	標準( 280)	65
1001	標準( 135)	PAC-CH58SP( 236)	61			
969				PAC-CH66MP( 155)	標準( 280)	64
945	標準( 135)	PAC-CH40SP( 250)	62			
906				PAC-CH65MP( 145)	標準( 280)	64
906	PAC-CH63MP( 145)	標準( 280)	65			
844	標準( 135)	標準( 280)	64			
788	標準( 135)	PAC-CH60SP( 300)	66			
750	標準( 135)	PAC-CH61SP( 315)	66			
694	PAC-CH62MP( 125)	PAC-CH61SP( 315)	66			

- 注1. モーターを5.5kWにした場合、51F (過電流継電器) の設定値は22.5Aとなります。  
 2. Vベルトは、モーターブリー、またはファンブリーに付属しています。  
 3. 標準仕様は機内抵抗220Pa、機外静圧130Pa、風量180m<sup>3</sup>/minです。  
 4. 別売プレナムは機外静圧30Paです。表 のブリー仕様でご使用ください。(風量180m<sup>3</sup>/min)  
 5. 機内抵抗はフレッドフィルターなど別売部品を組み込んだ場合に変わりますので補正が必要です。該当する部品の圧損線図を参照の上、補正をしてください。

(4) 壁ビルトイン形

PFFY-P112RM-E1

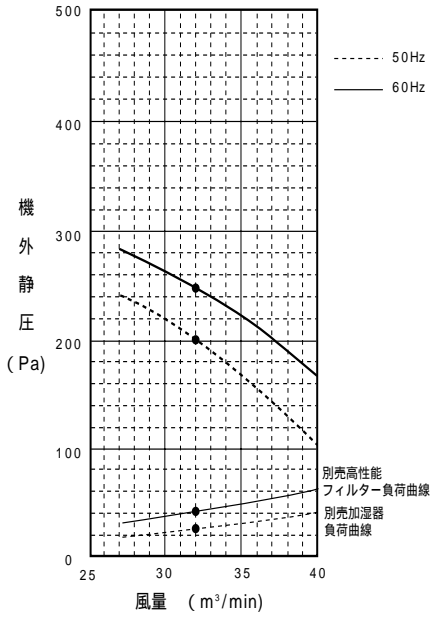

PFFY-P140RM-E1

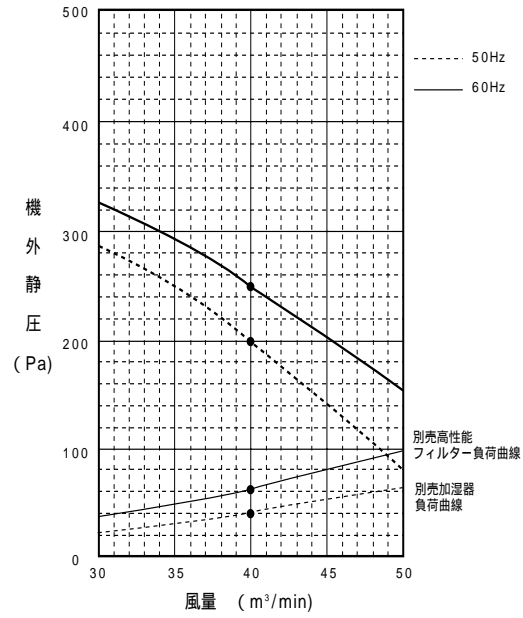

PFFY-P224RM-E1

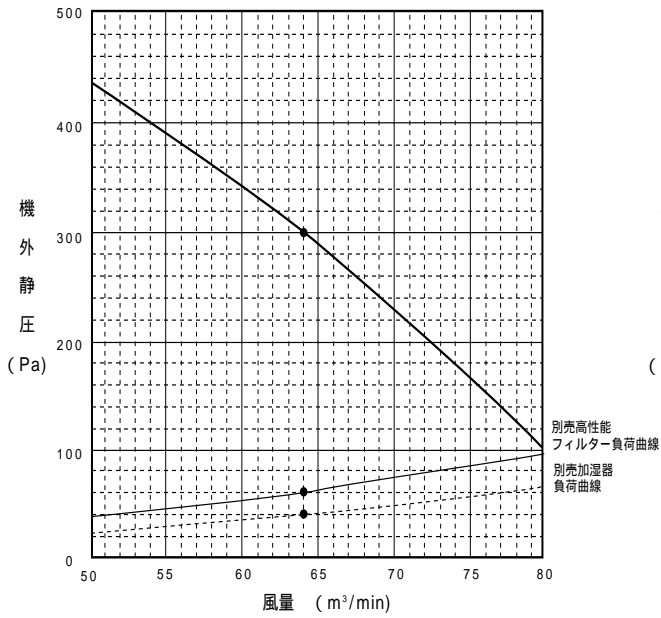

PFFY-P280RM-E1

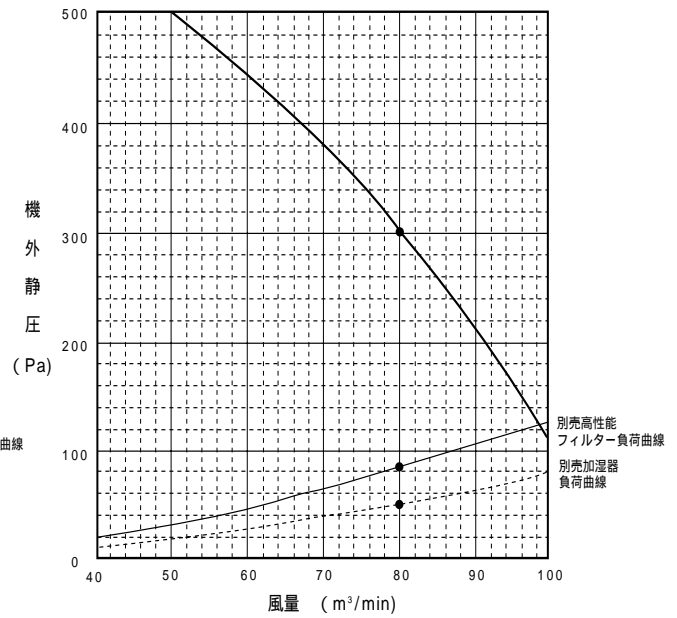

(5) ホテル向天井埋込形  
PEFY-P22・28ML-E(-R)

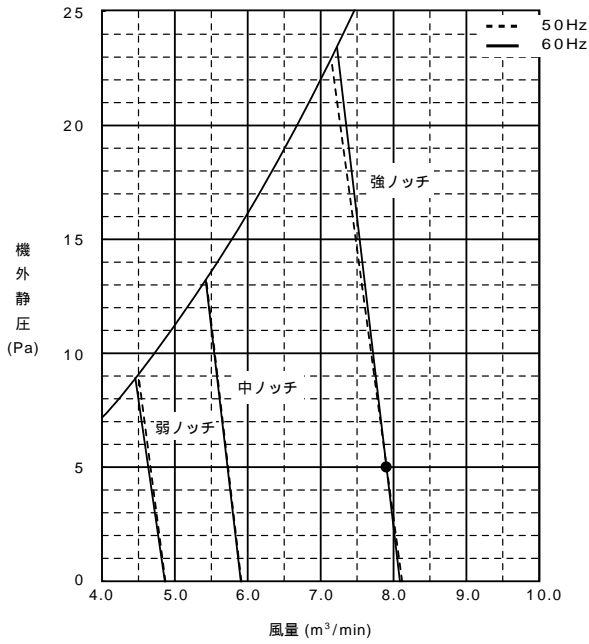

(6) オールフレッシュ  
PEFY-P90M-E1-F

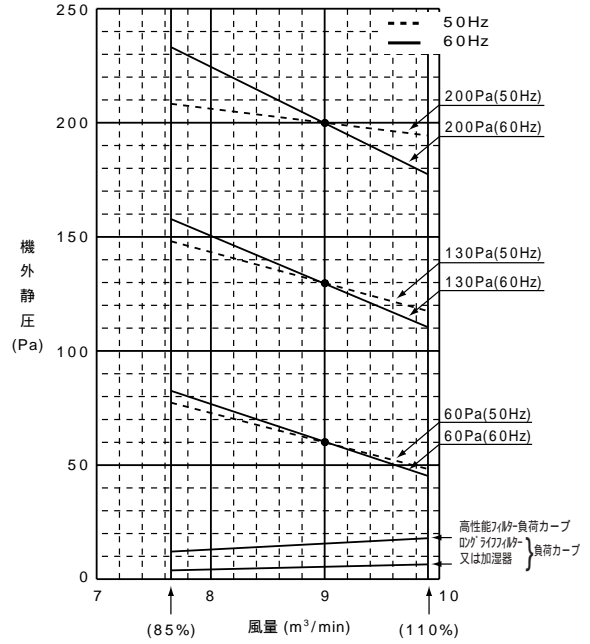

PEFY-P112・140M-E1-F

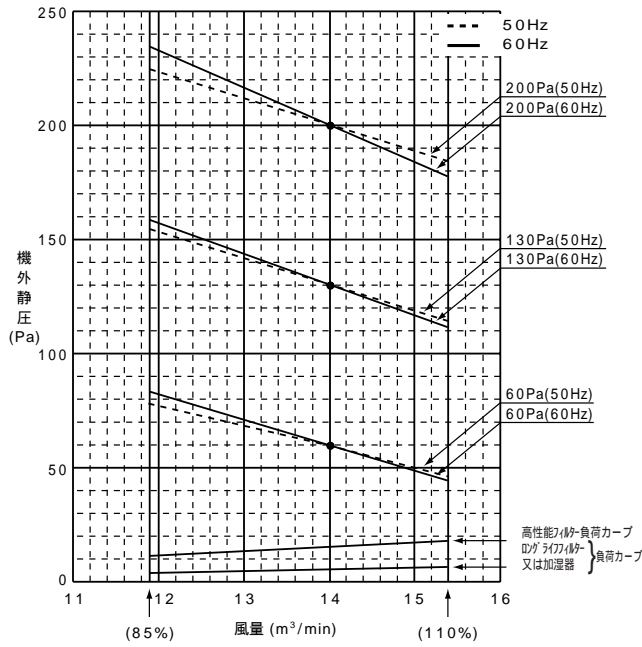

PEFY-P160M-E1-F

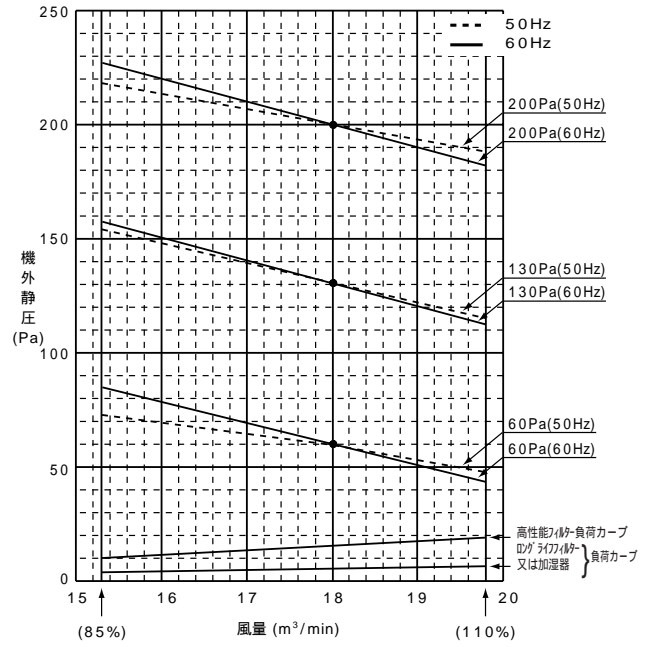

PEFY-P224M-E1-F

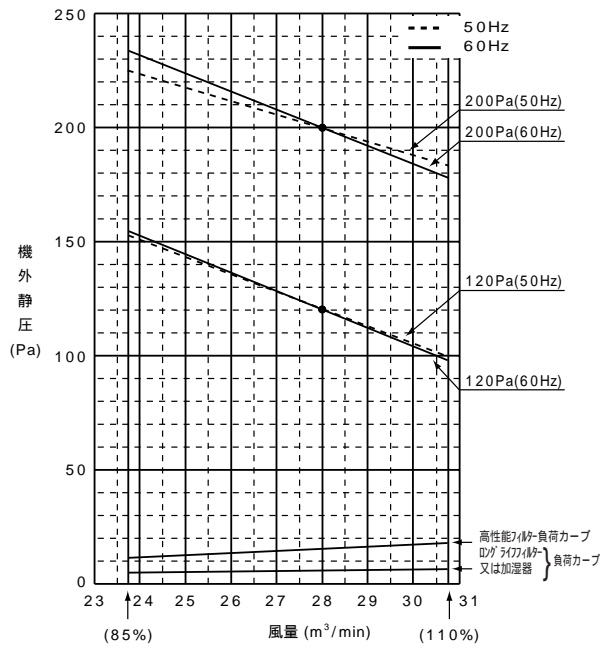

PEFY-P280M-E1-F

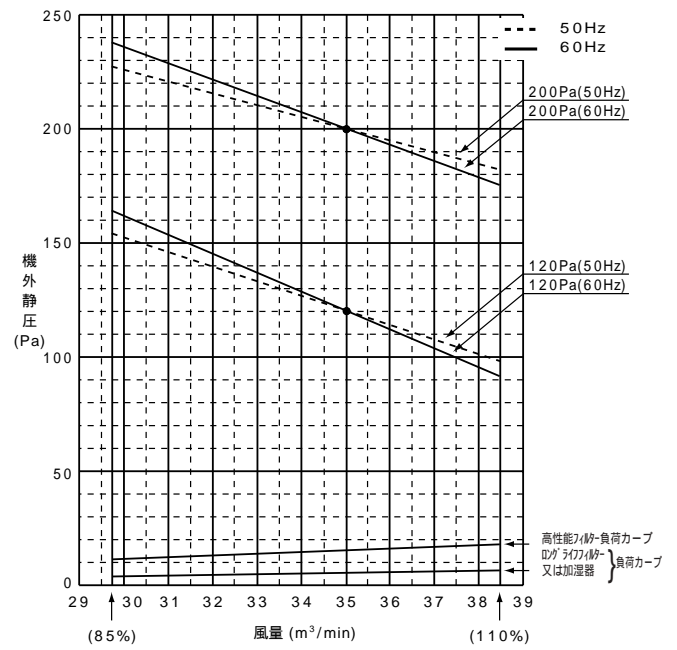

PFFY-P280RM-E1-F

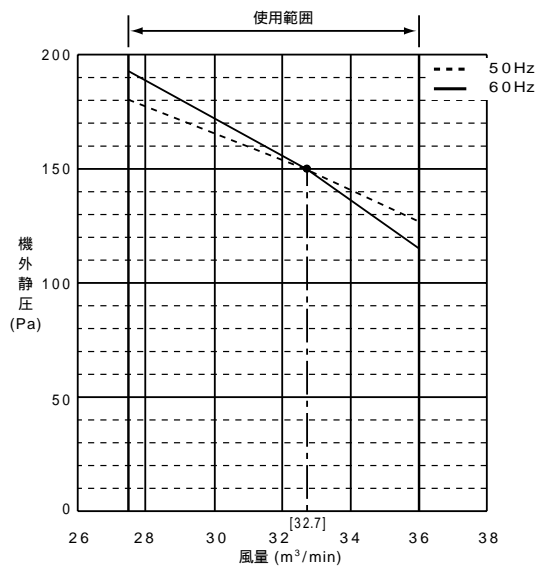

(7) クリーンルーム用カセット形

PLFY-P36CLMD-E1

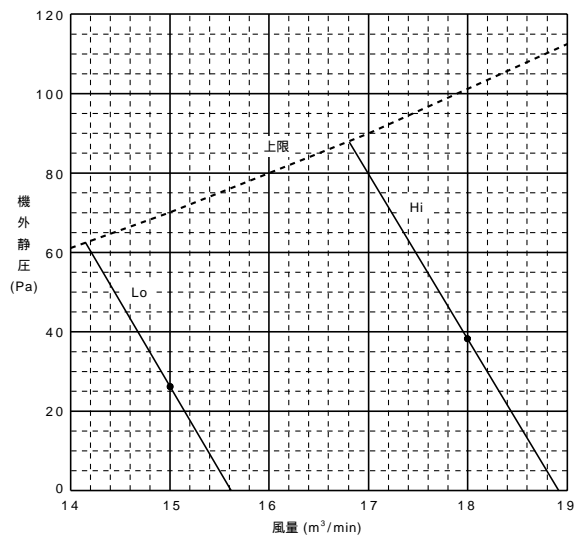

PLFY-P45・56CLMD-E1

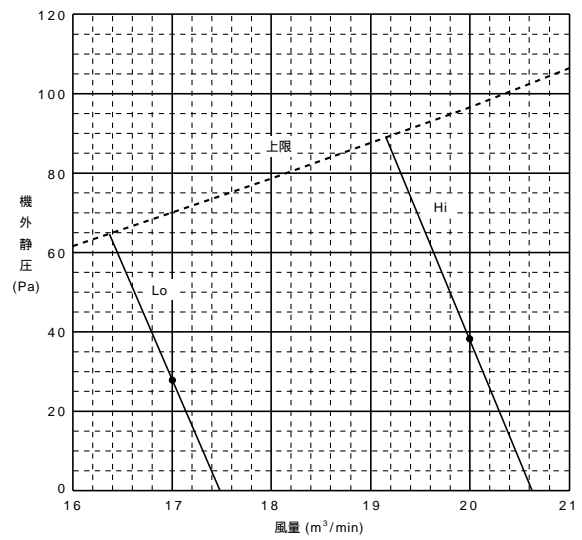

PLFY-P71・80CLMD-E1

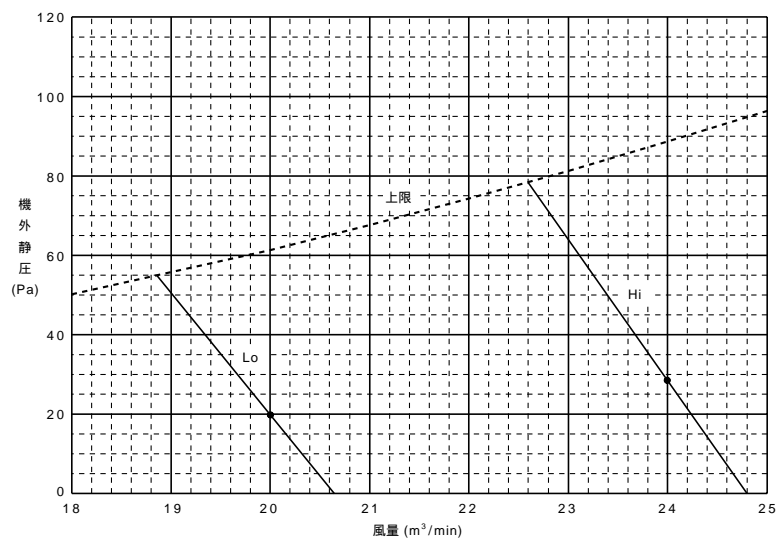

## 4. 外気取入風量特性線図

### (1) 天井カセット形

PLFY-P22・28・36・45・56・71・80・90AM-E1

(4方向吹出しタイプ)

多機能ケースメント + 標準フィルター

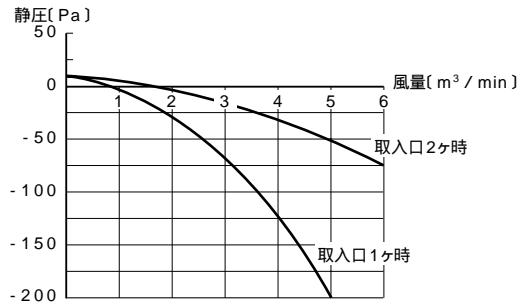

多機能ケースメント + 高性能フィルター

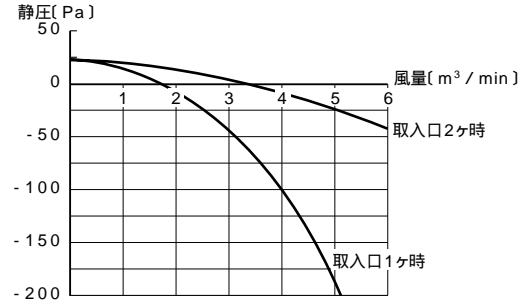

本体直接取入

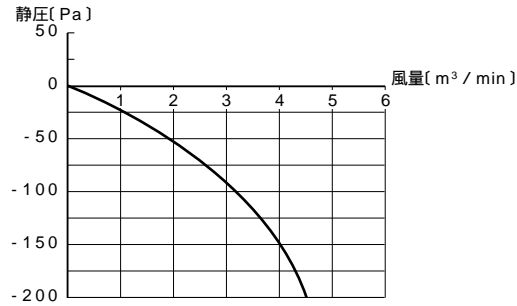

PLFY-P112・140・160AM-E1 (4方向吹出しタイプ)

多機能ケースメント + 標準フィルター

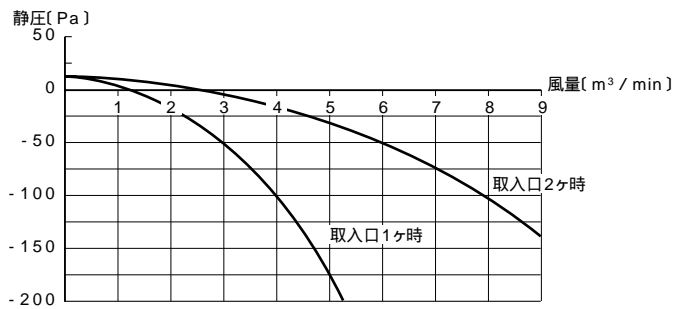

多機能ケースメント + 高性能フィルター

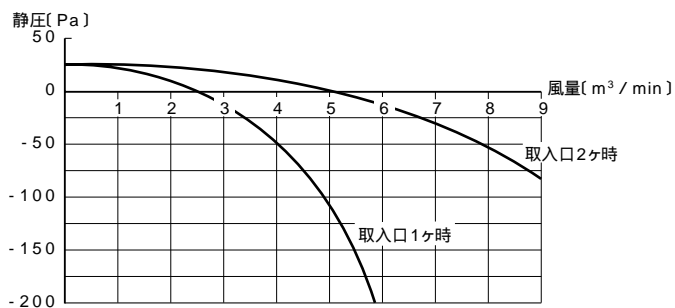

本体直接取入

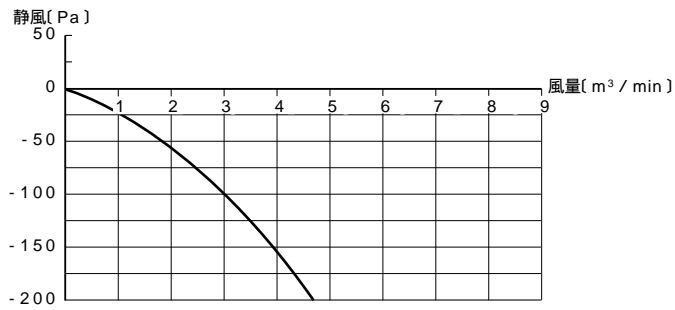

PLFY-P22 ~ 112LMD-E1 (2方向吹出しタイプ)    PLYF-P140LMD-E1 (2方向吹出しタイプ)

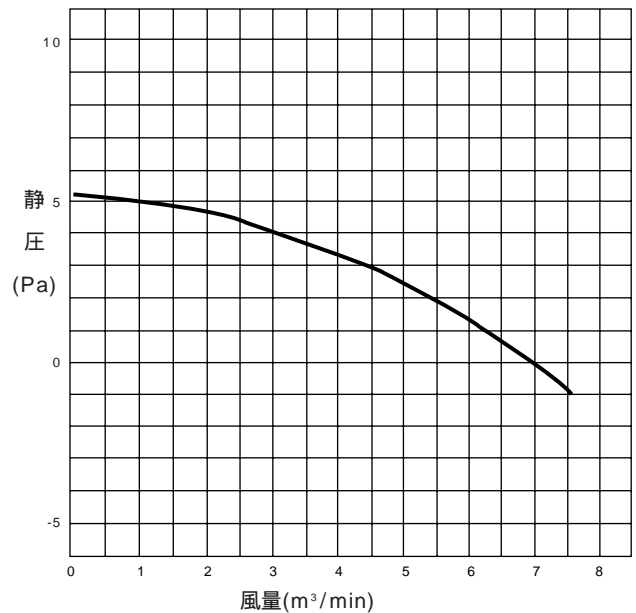
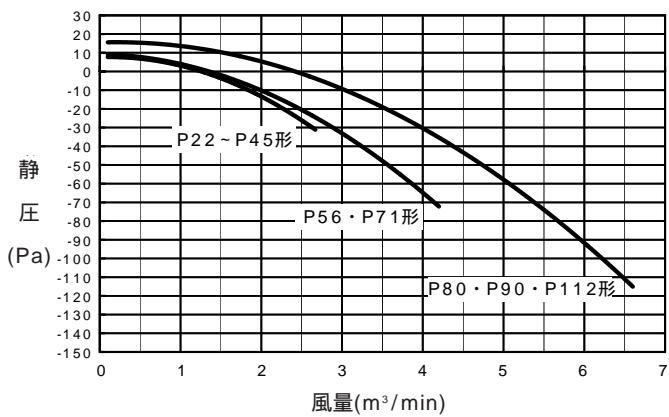

(2) ビルトイン形

PDFY-M-E1

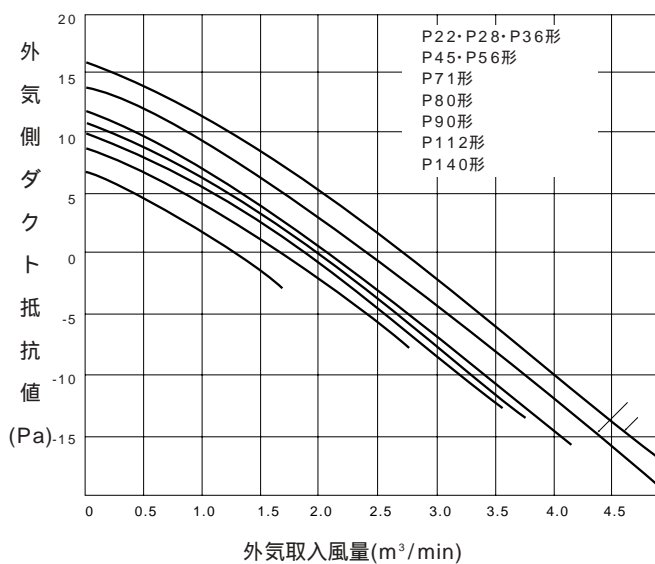

(3) クリーンルーム用カセット形

PLFY-CLMD-E1

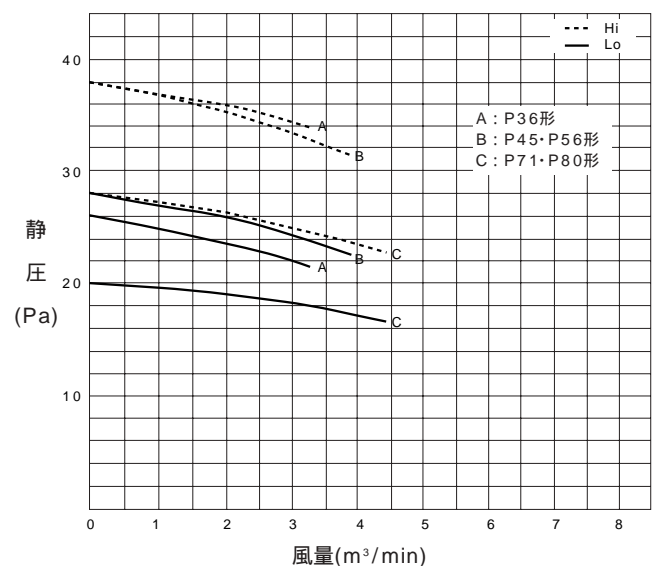

## 5. 分ダクト風量特性線図

天井カセット形

PLFY-P22・28AM-E1

4方向吹出し（ベーン水平）角形ダクト

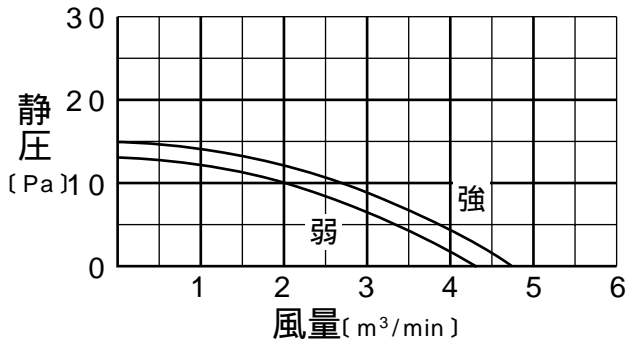

4方向吹出し（ベーン水平）丸形ダクト

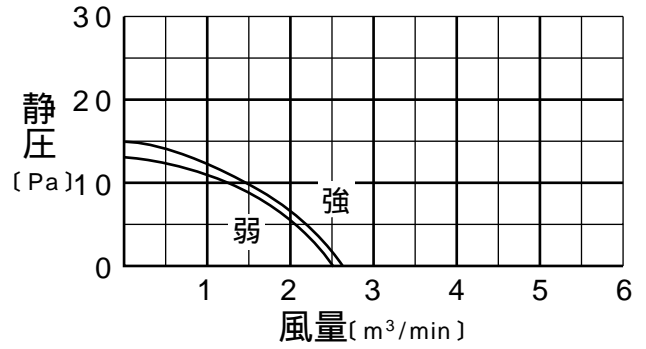

3方向吹出し（ベーン水平）角形ダクト

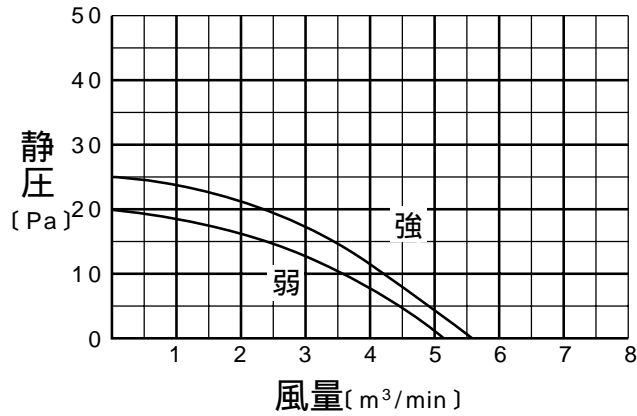

3方向吹出し（ベーン水平）丸形ダクト

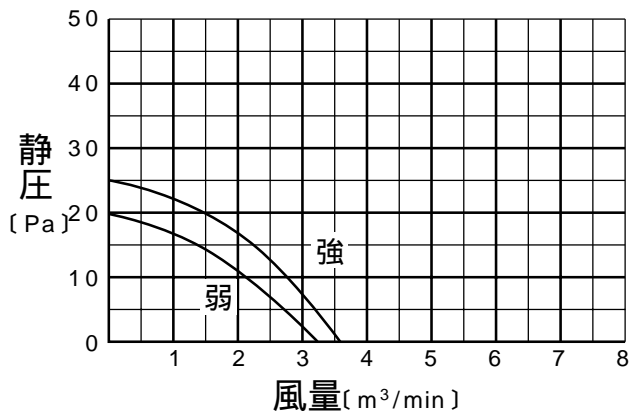

2方向吹出し（ベーン水平）角形ダクト

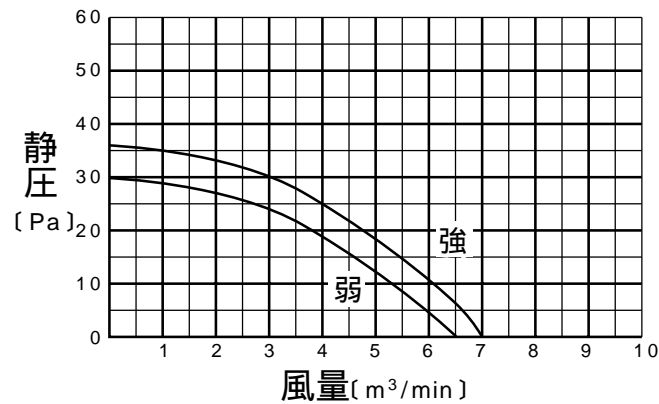

2方向吹出し（ベーン水平）丸形ダクト

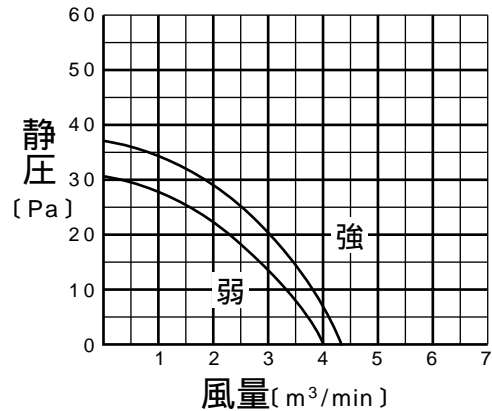



PLFY-P36AM-E1

4方向吹出し（ベーン水平）角形ダクト

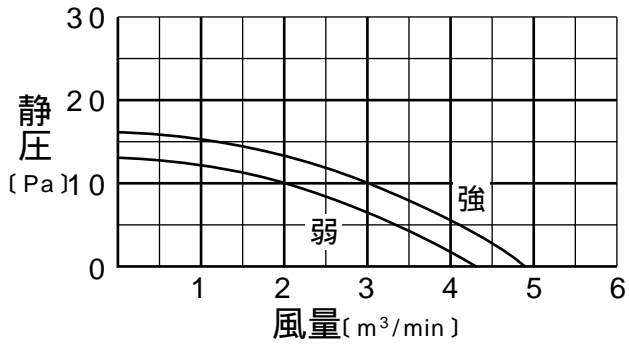

4方向吹出し（ベーン水平）丸形ダクト

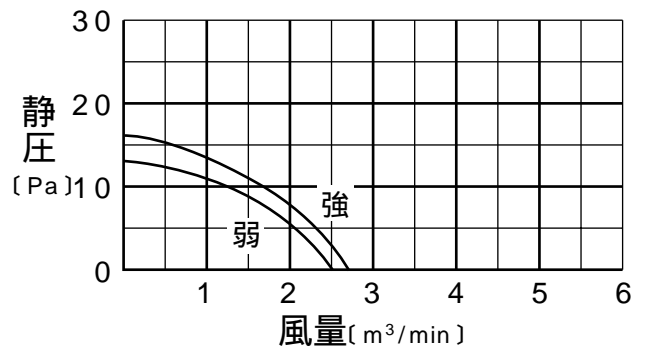

3方向吹出し（ベーン水平）角形ダクト

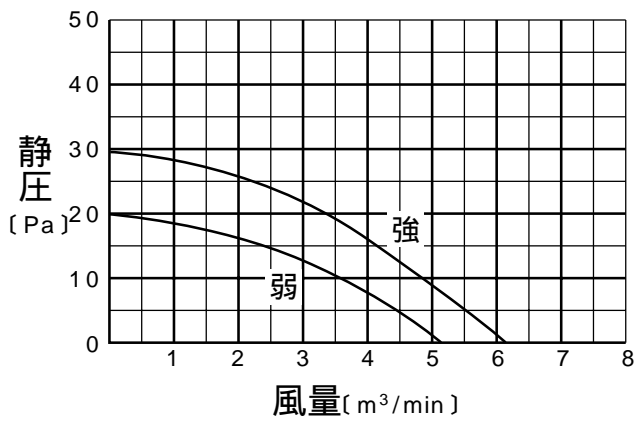

3方向吹出し（ベーン水平）丸形ダクト

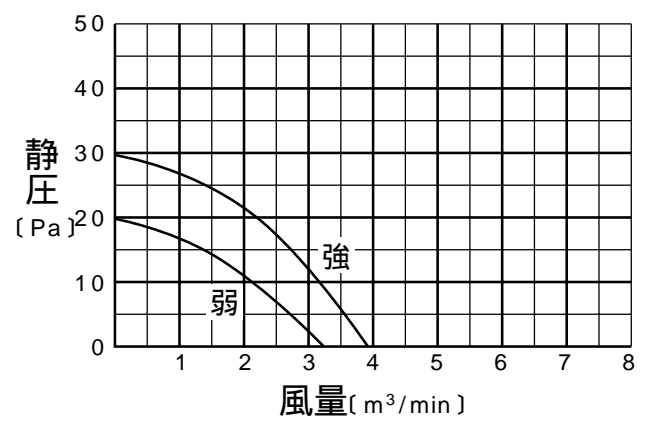

2方向吹出し（ベーン水平）角形ダクト

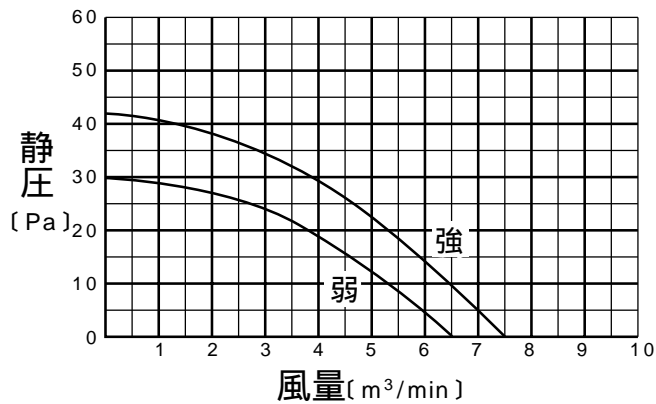

2方向吹出し（ベーン水平）丸形ダクト

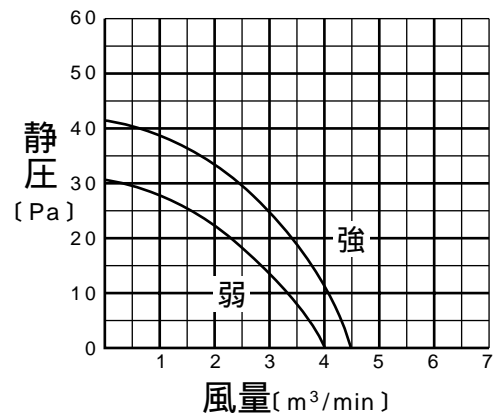

PLFY-P45・P56AM-E1

4方向吹出し（ベーン水平）角形ダクト

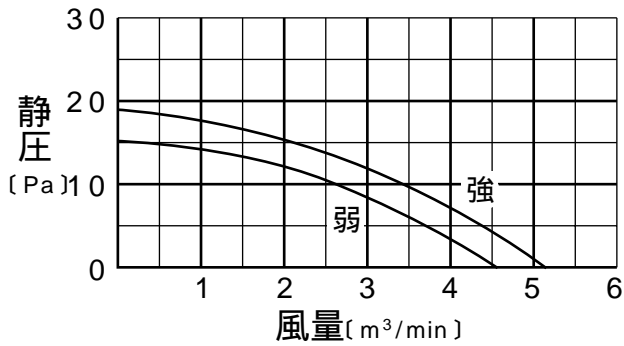

4方向吹出し（ベーン水平）丸形ダクト

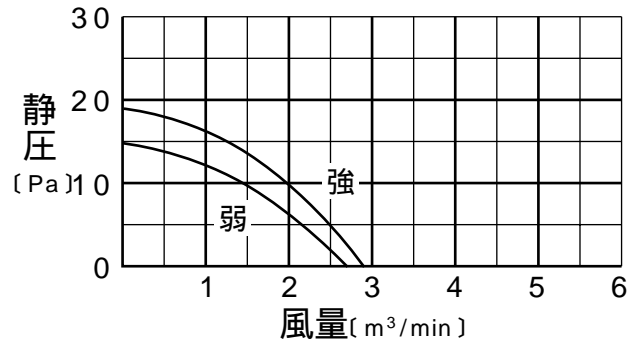

3方向吹出し（ベーン水平）角形ダクト

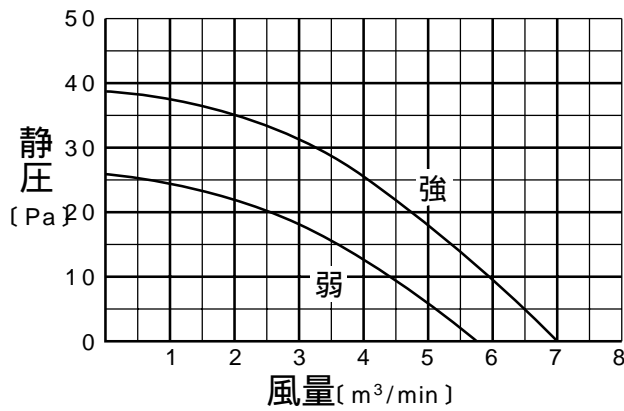

3方向吹出し（ベーン水平）丸形ダクト

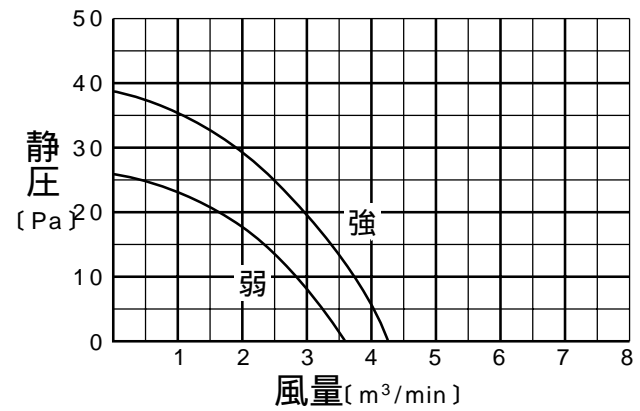

2方向吹出し（ベーン水平）角形ダクト

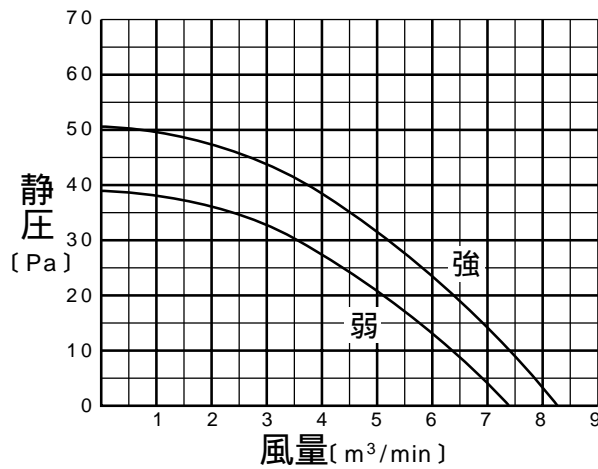

2方向吹出し（ベーン水平）丸形ダクト

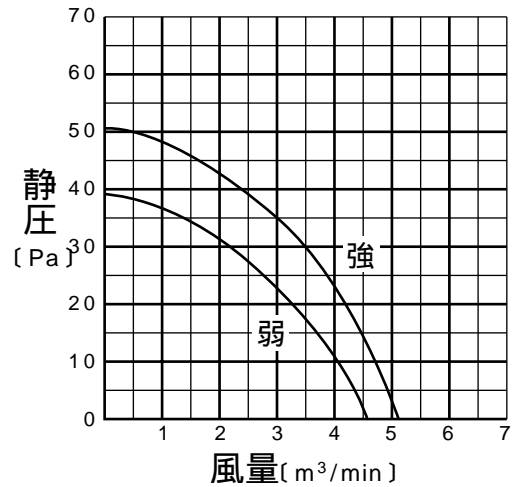

PLFY-P71AM-E1

4方向吹出し（ベーン水平）角形ダクト

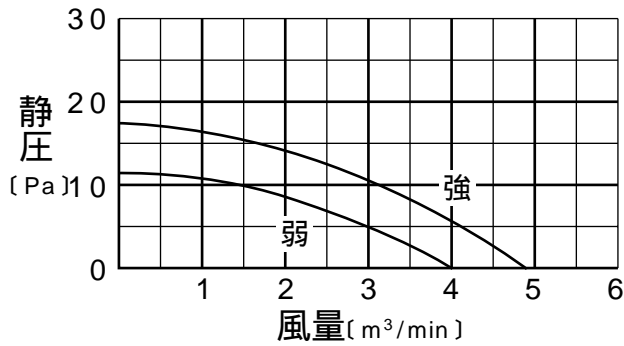

4方向吹出し（ベーン水平）丸形ダクト

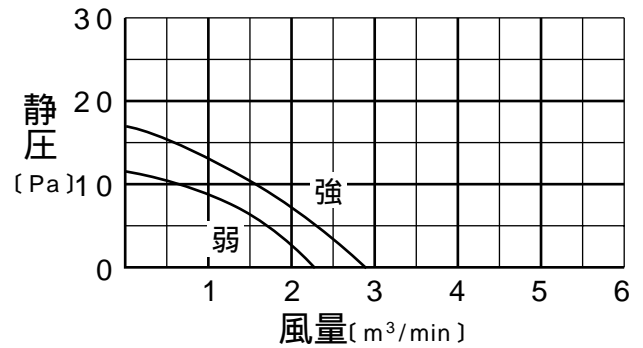

3方向吹出し（ベーン水平）角形ダクト

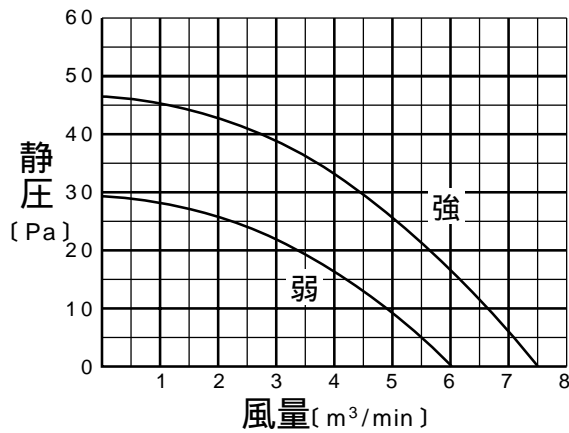

3方向吹出し（ベーン水平）丸形ダクト

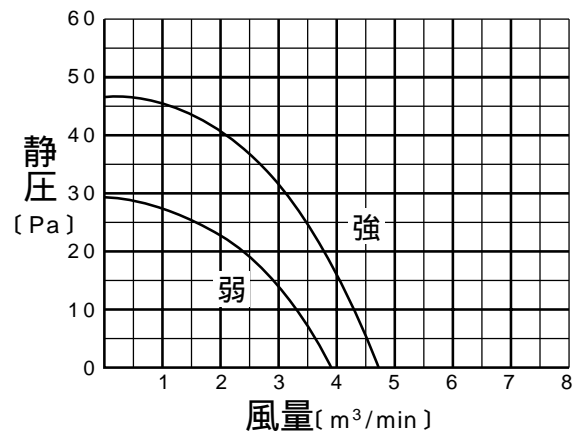

2方向吹出し（ベーン水平）角形ダクト

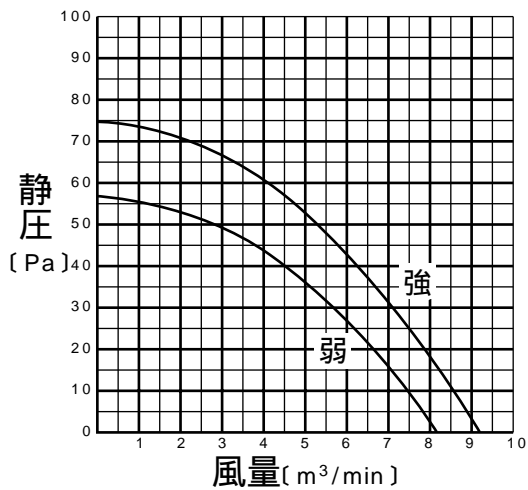

2方向吹出し（ベーン水平）丸形ダクト

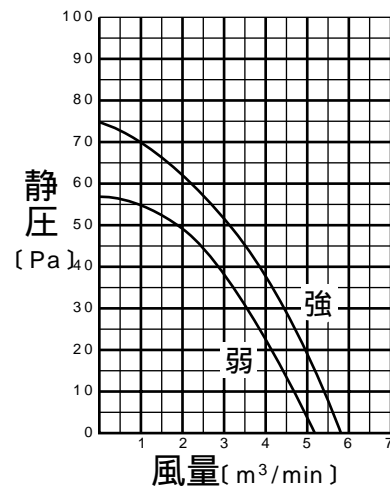

PLFY-P80AM-E1

4方向吹出し（ベーン水平）角形ダクト

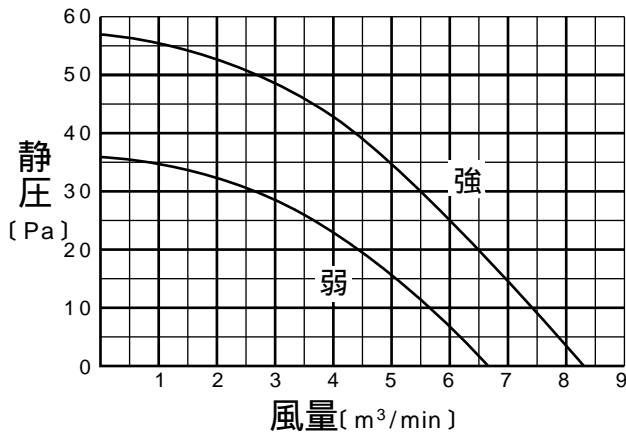

4方向吹出し（ベーン水平）丸形ダクト

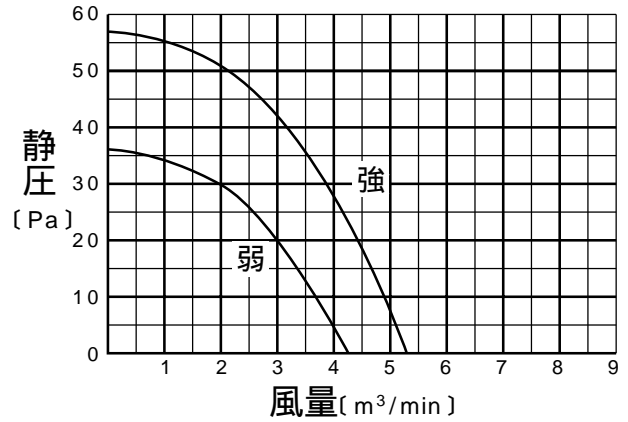

3方向吹出し（ベーン水平）角形ダクト

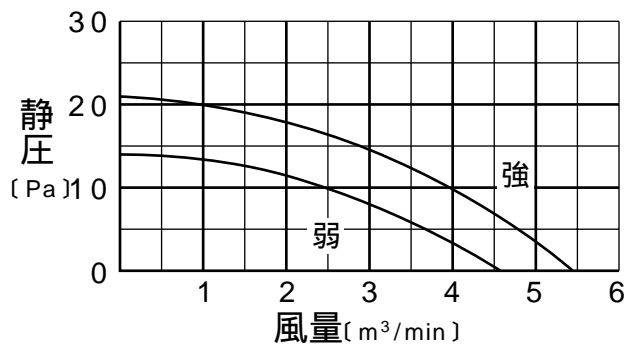

3方向吹出し（ベーン水平）丸形ダクト

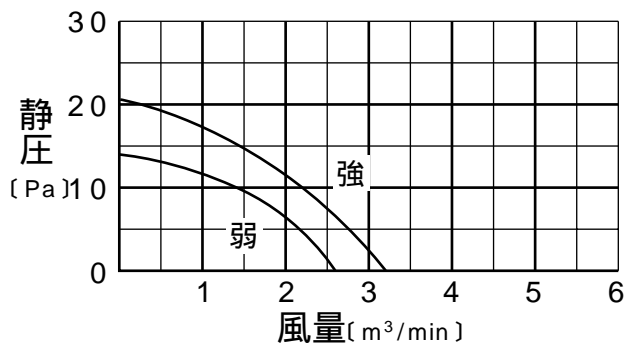

2方向吹出し（ベーン水平）角形ダクト

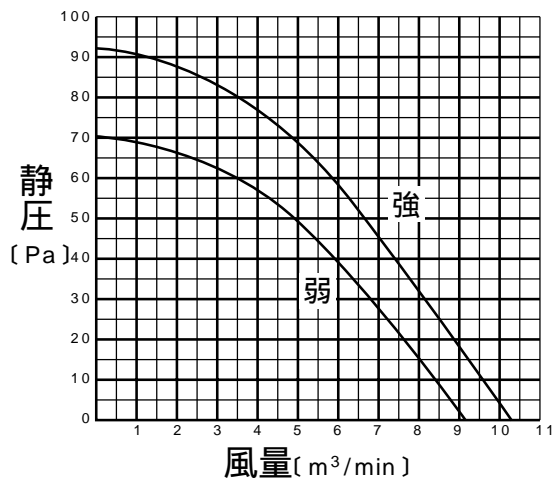

2方向吹出し（ベーン水平）丸形ダクト

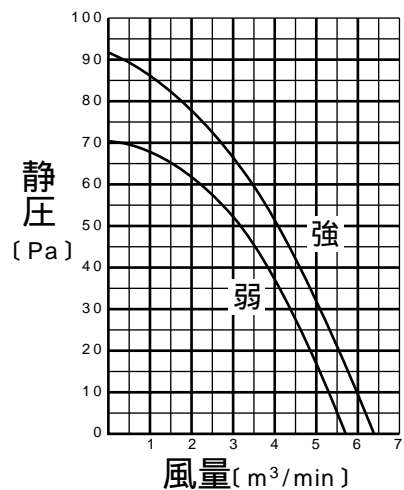

PLFY-P90AM-E1

4方向吹出し（ベーン水平）角形ダクト

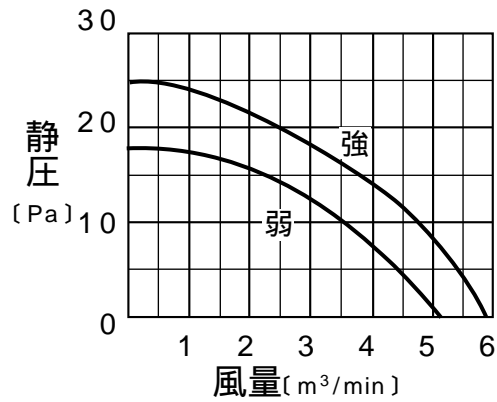

4方向吹出し（ベーン水平）丸形ダクト

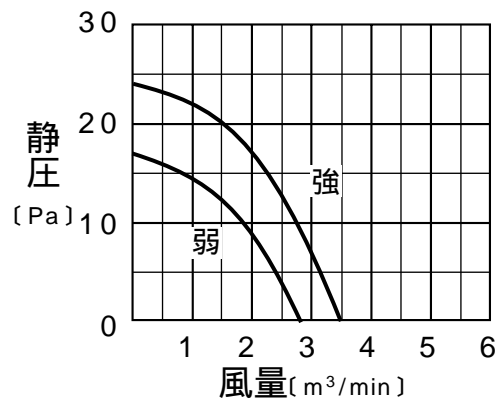

3方向吹出し（ベーン水平）角形ダクト

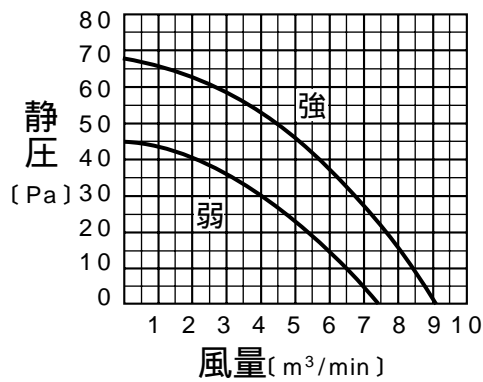

3方向吹出し（ベーン水平）丸形ダクト

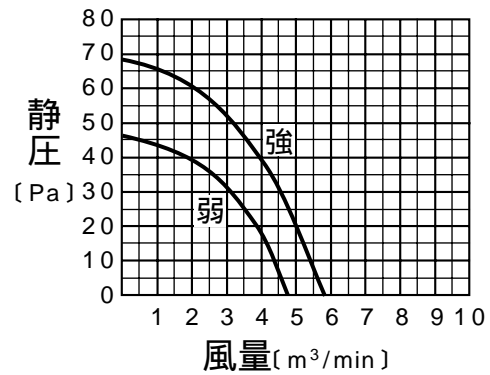

2方向吹出し（ベーン水平）角形ダクト

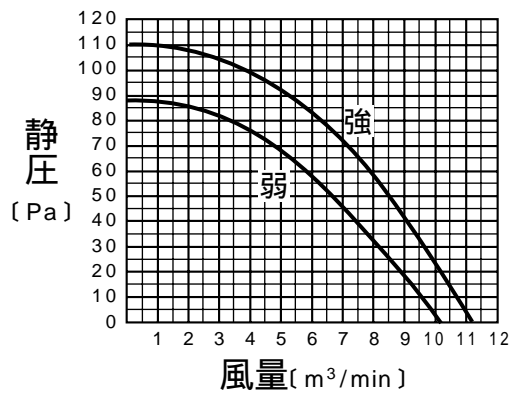

2方向吹出し（ベーン水平）丸形ダクト

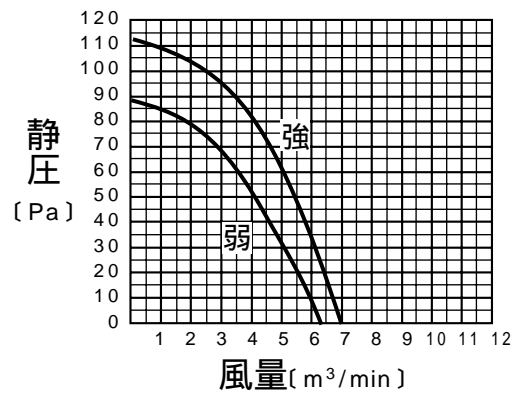

PLFY-P112AM-E1

4方向吹出し（ベーン水平）角形ダクト

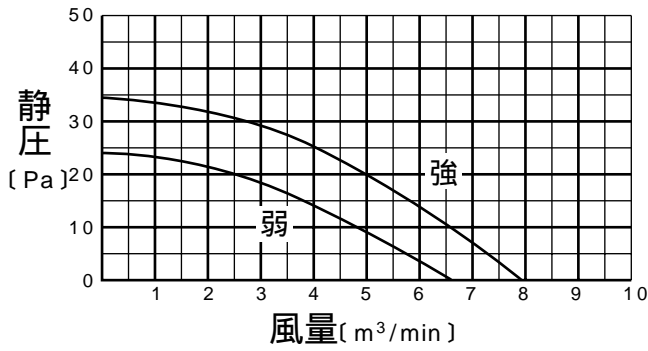

4方向吹出し（ベーン水平）丸形ダクト

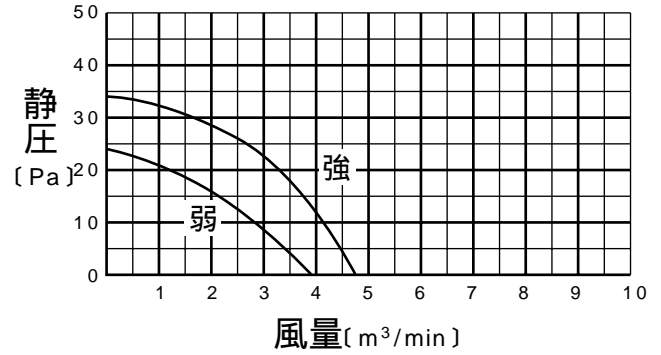

3方向吹出し（ベーン水平）角形ダクト

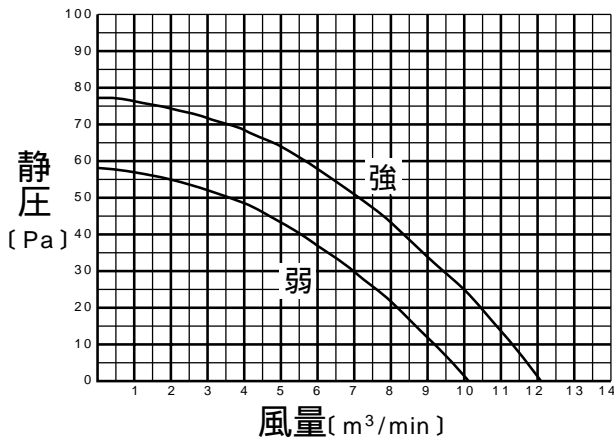

3方向吹出し（ベーン水平）丸形ダクト

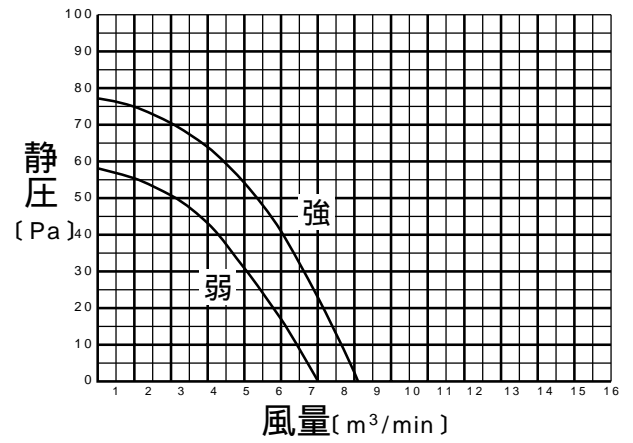

2方向吹出し（ベーン水平）角形ダクト

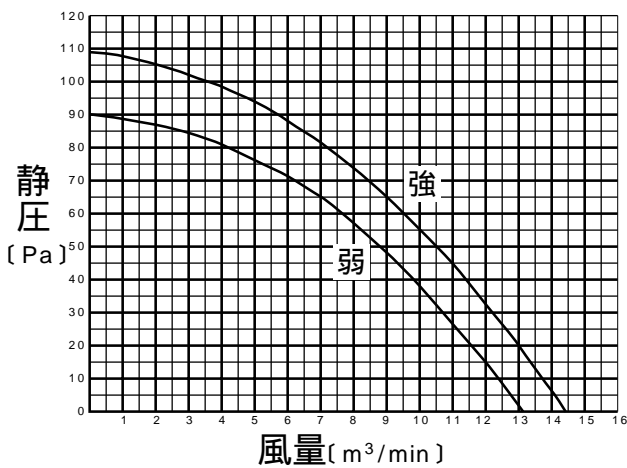

2方向吹出し（ベーン水平）丸形ダクト

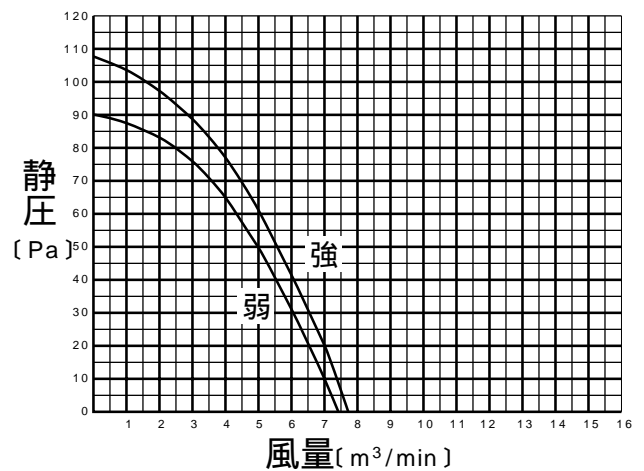

PLFY-P140・160AM-E1

4方向吹出し（ベーン水平）角形ダクト

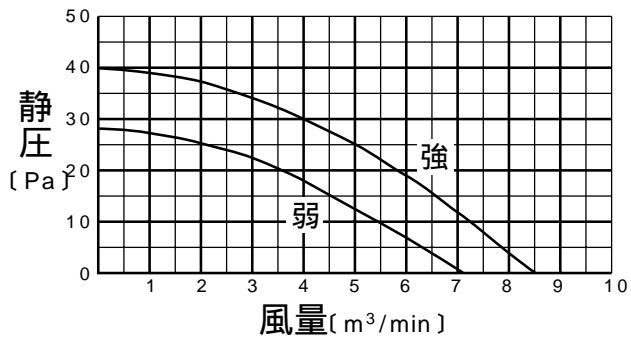

4方向吹出し（ベーン水平）丸形ダクト

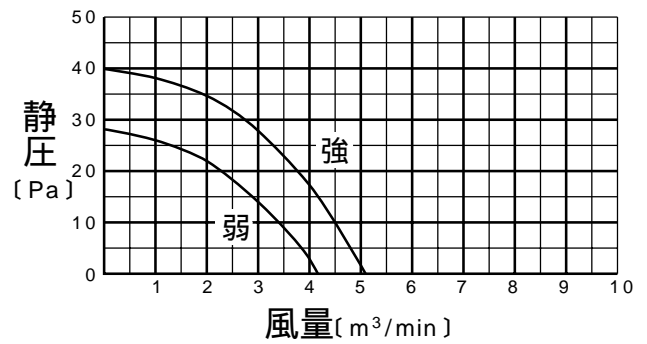

3方向吹出し（ベーン水平）角形ダクト

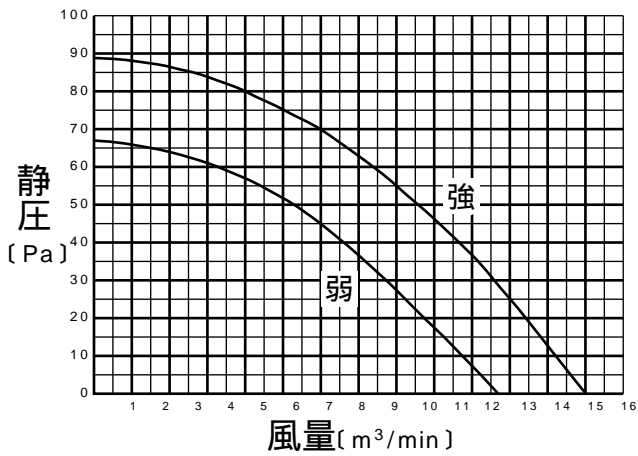

3方向吹出し（ベーン水平）丸形ダクト

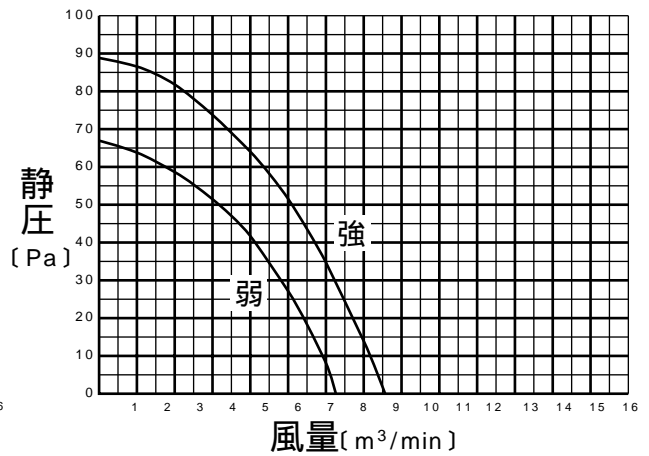

2方向吹出し（ベーン水平）角形ダクト

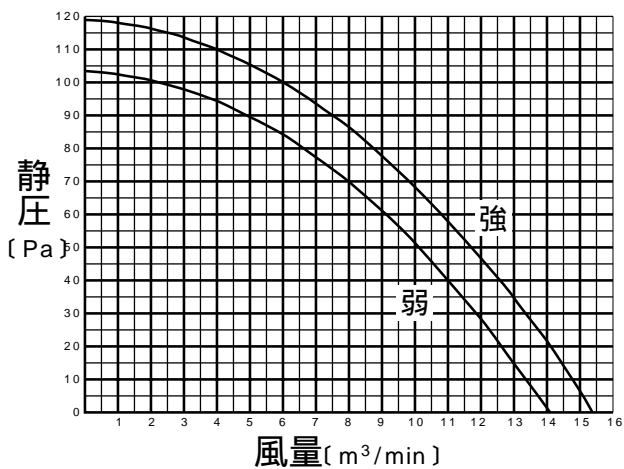

2方向吹出し（ベーン水平）丸形ダクト

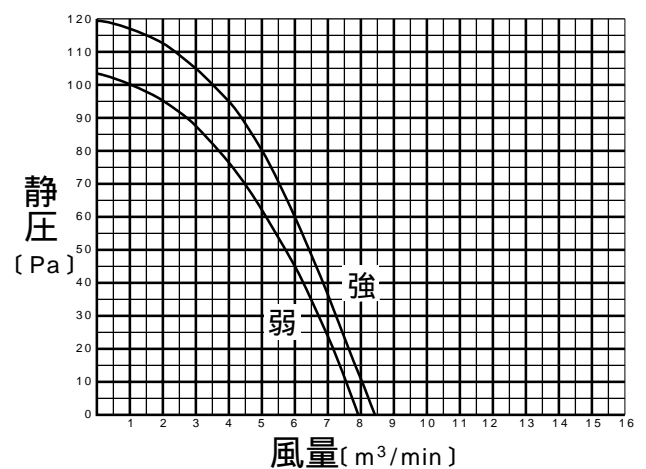

PLFY-P22・P28・P36・P45LMD-E1

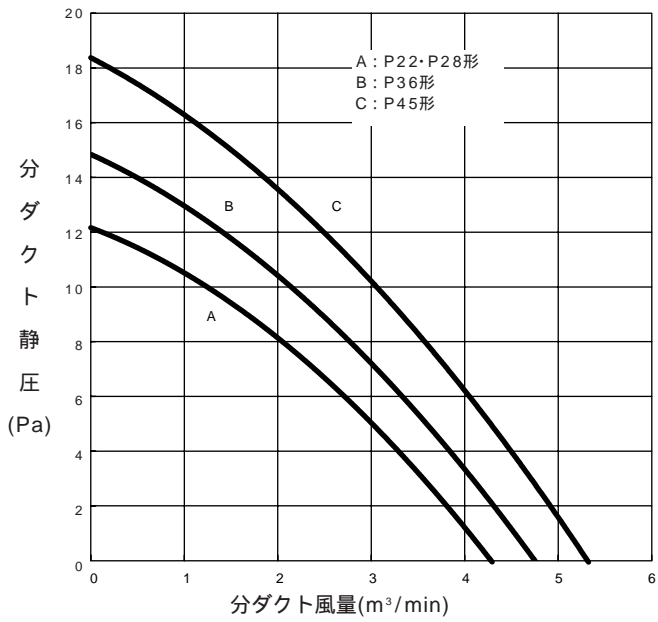

PLFY-P56・P71LMD-E1

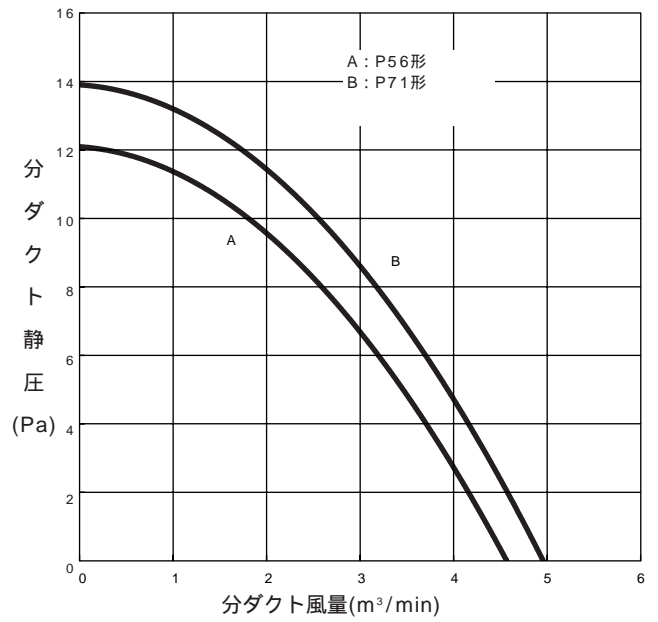

PLFY-P80・P90・P112LMD-E1

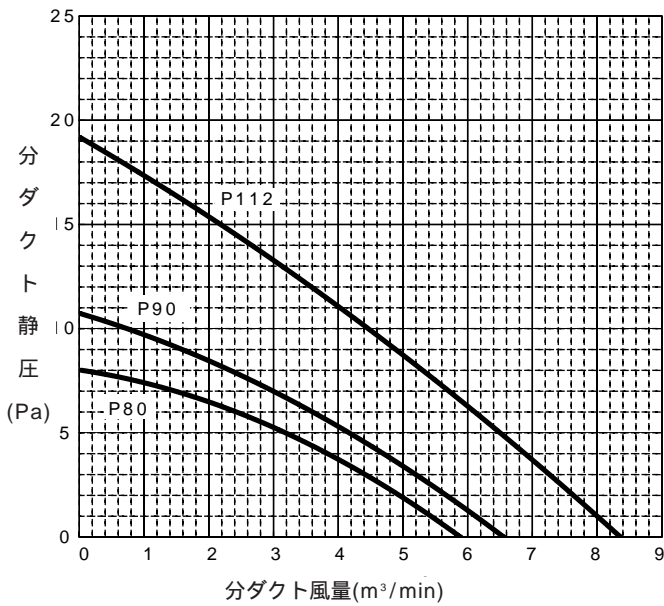

PLFY-P140LMD-E1

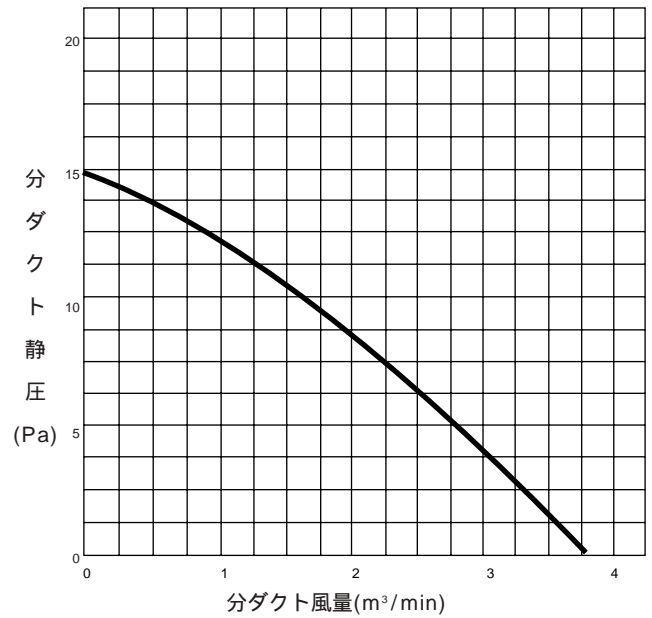



## 6. 温度・気流分布

### (1) 天井カセット形

PLFY-P80AM-E1 (4方向吹出しタイプ)

[ 冷房・温度分布 ]

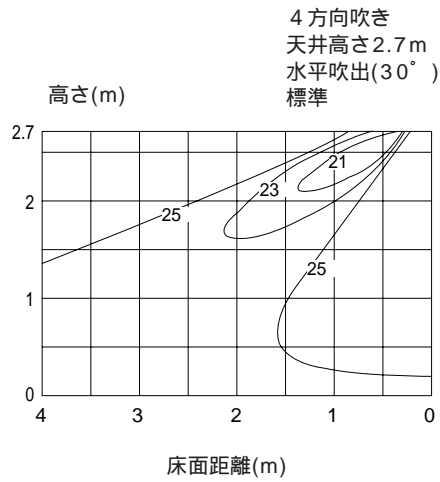
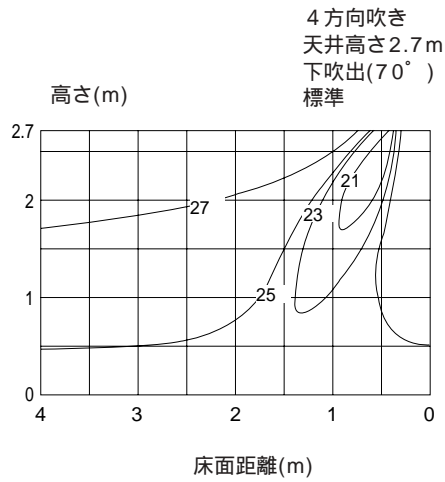

[ 暖房・温度分布 ]

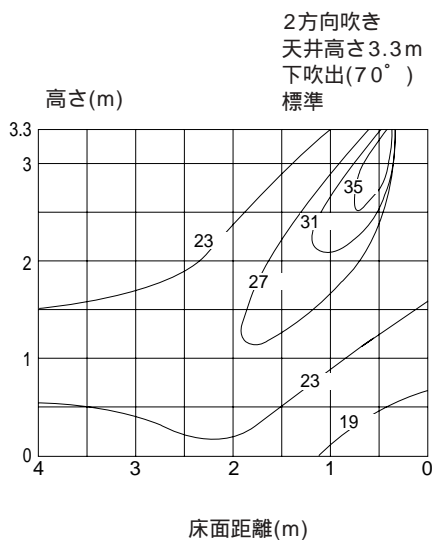
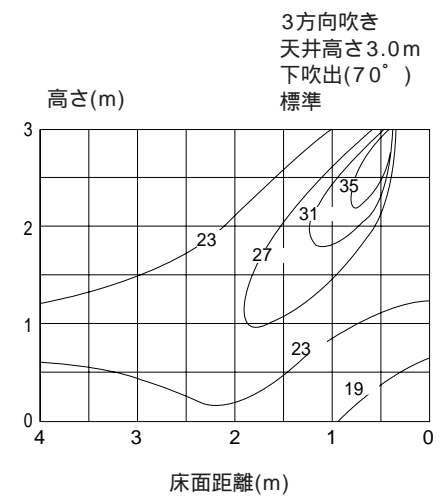
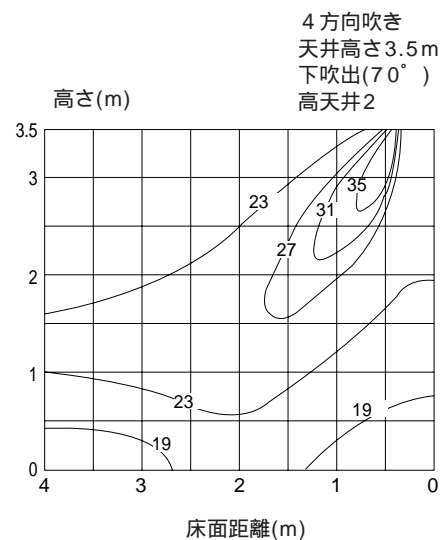
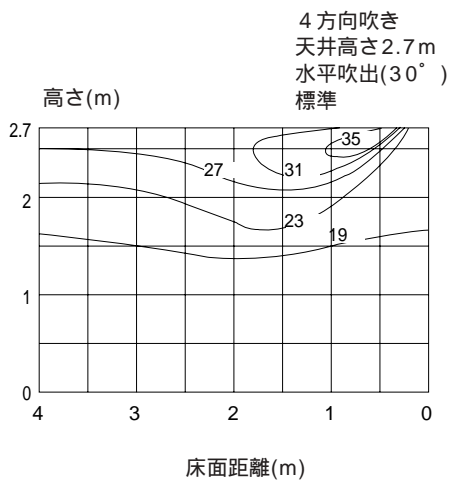
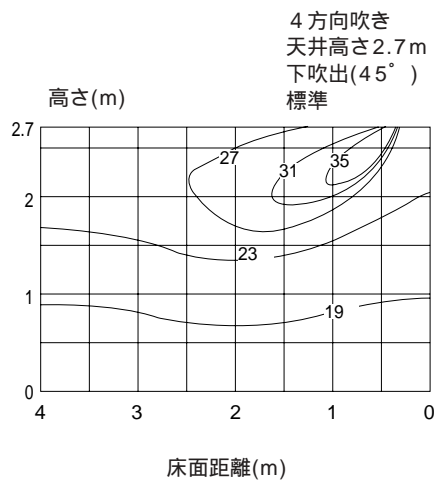
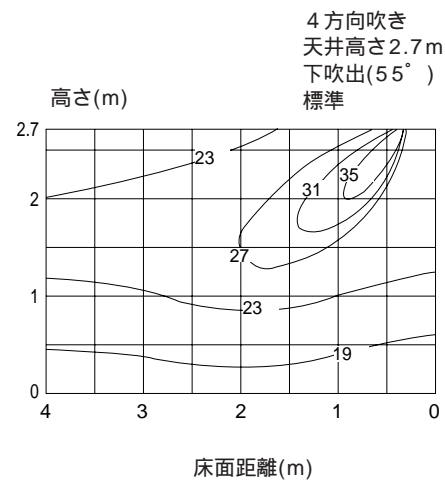
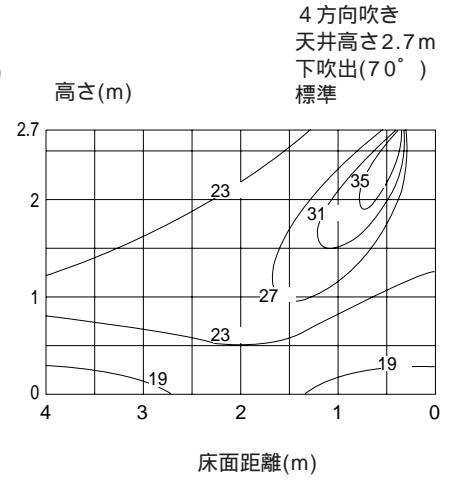

PLFY-P140AM-E1 (4方向吹出しタイプ)

[ 暖房・温度分布 ]

4方向吹き  
天井高さ3.2m  
下吹出(70°)  
標準

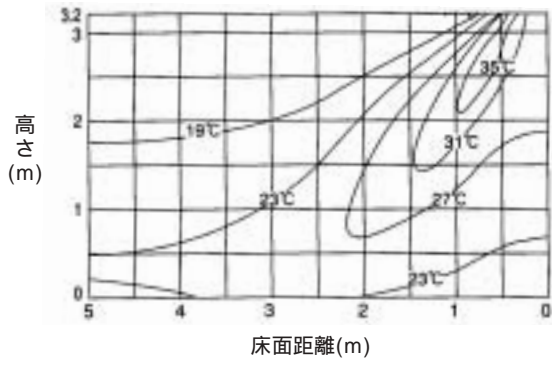

4方向吹き  
天井高さ4.2m  
下吹出(70°)  
高天井2

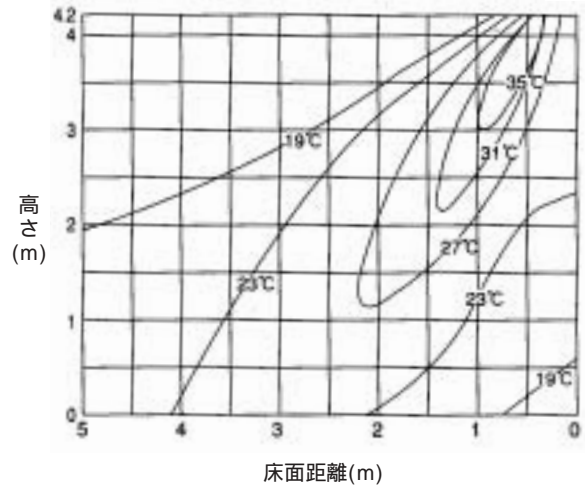

PLFY-LMD-E1 (2方向吹出しタイプ)

[ 冷房・温度分布 ]

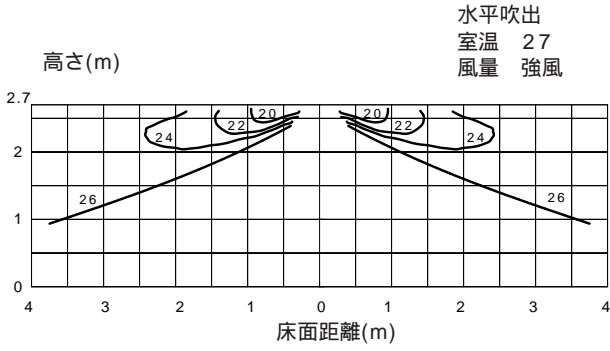

[ 冷房・気流分布 ]

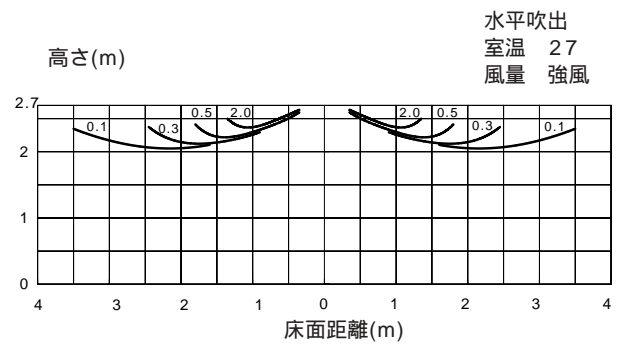

[ 暖房・温度分布 ]

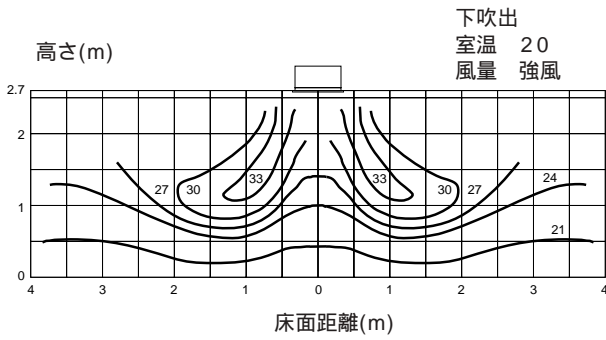

[ 暖房・気流分布 ]

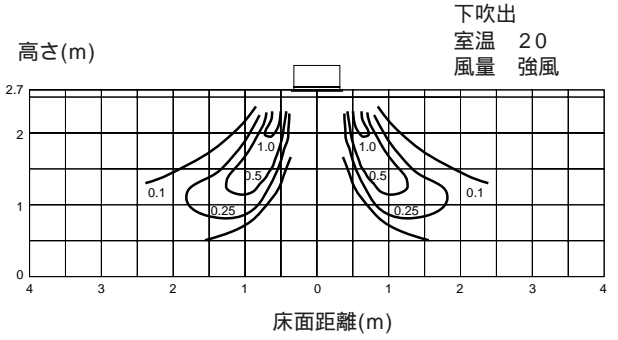

PMFY-EM-E1 (1方向吹出しタイプ)

[ 暖房・温度分布 ]

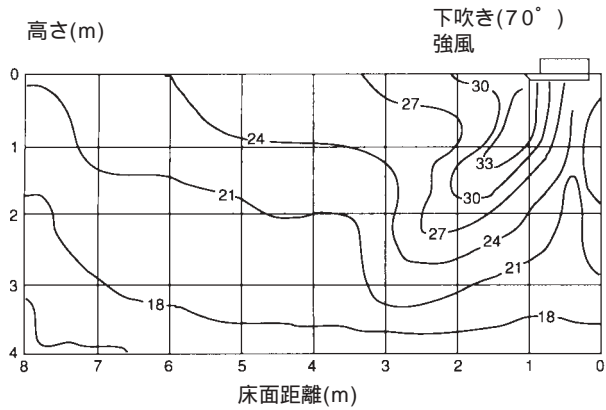

(2) 壁掛けタイプ

PKFY-GM-E1

[ 冷房・温度分布 ]

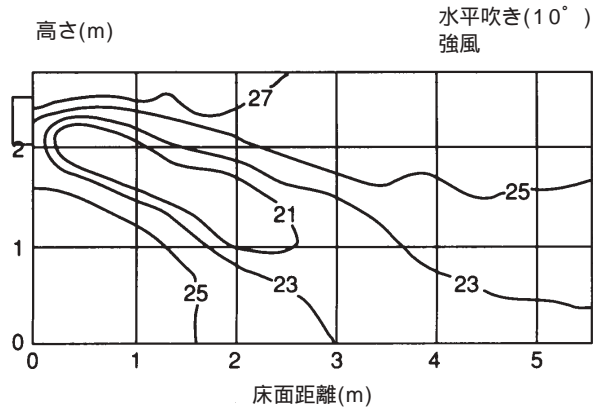

[ 暖房・温度分布 ]

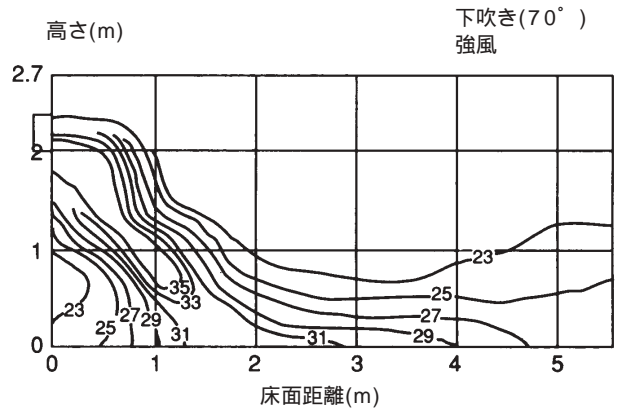

(3) 天吊形

PCFY-GM-E1

[ 冷房・温度分布 ]

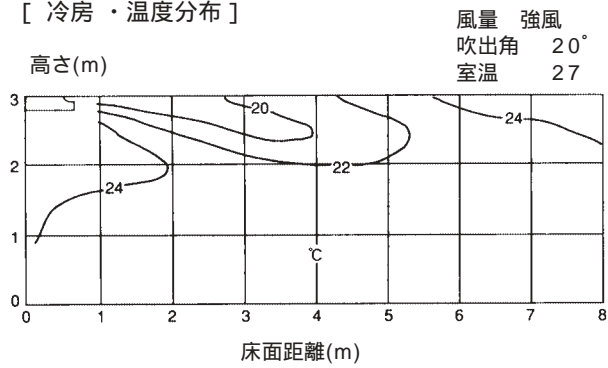

[ 暖房・温度分布 ]

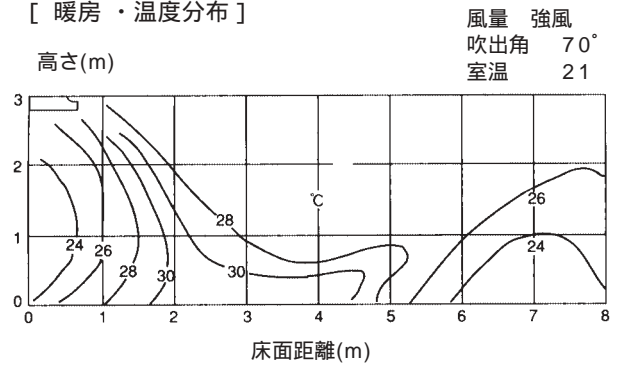

(4) クリーンルーム用カセット形

PLFY-CLMD-E1

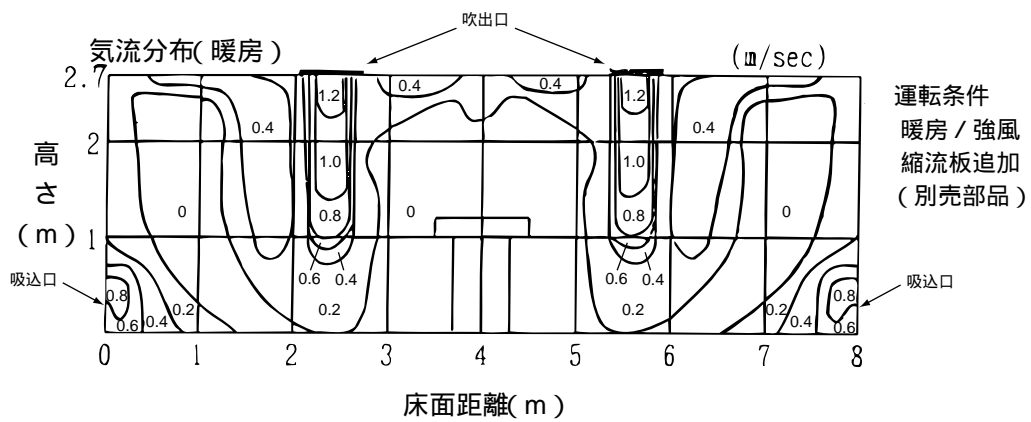
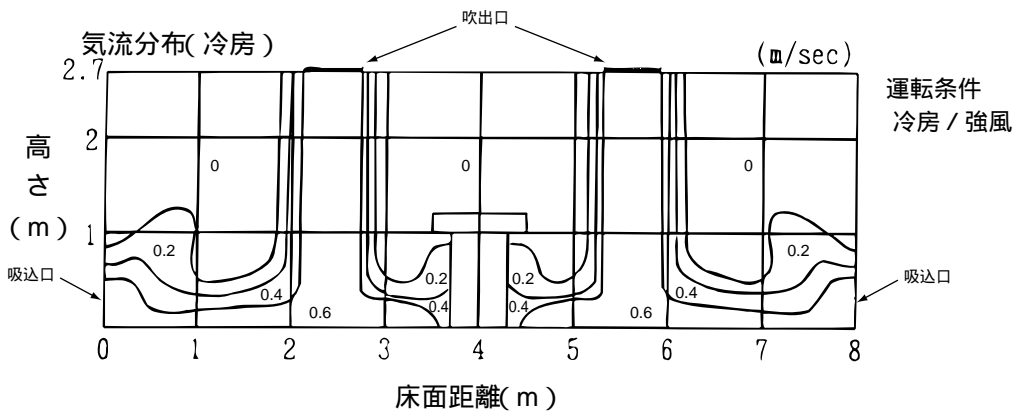
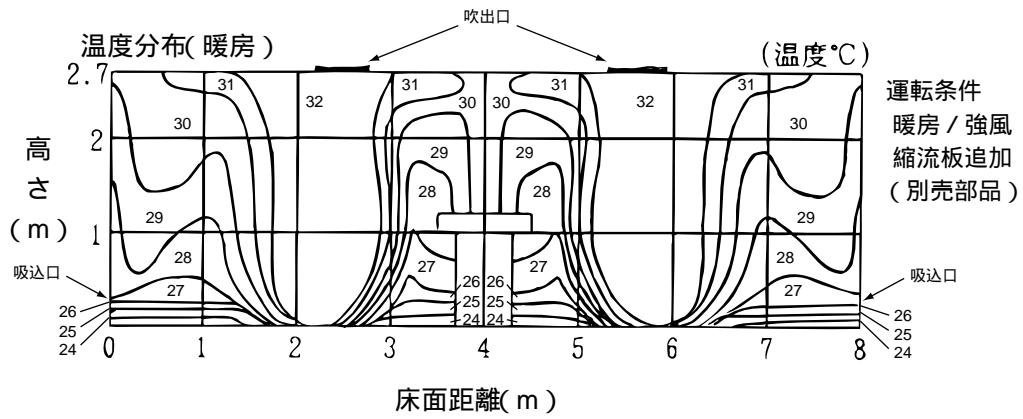
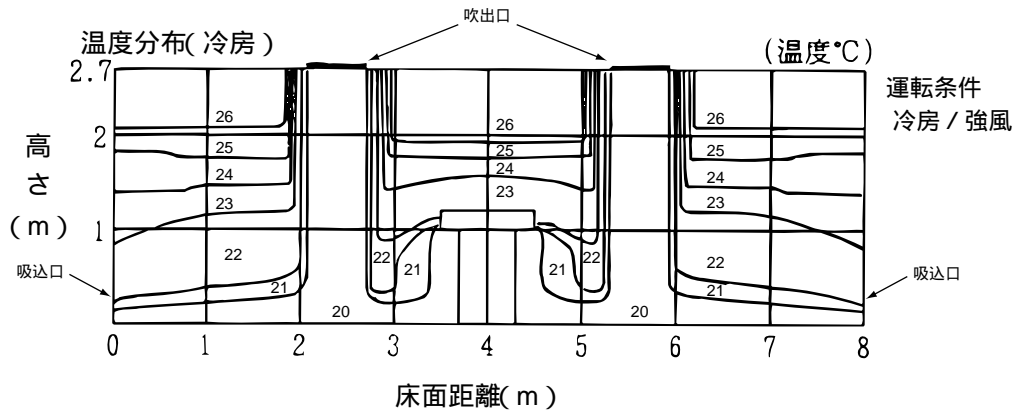

(5) 床置形

PSFY-GM-E1

[ 暖房 ・ 温度分布 ]

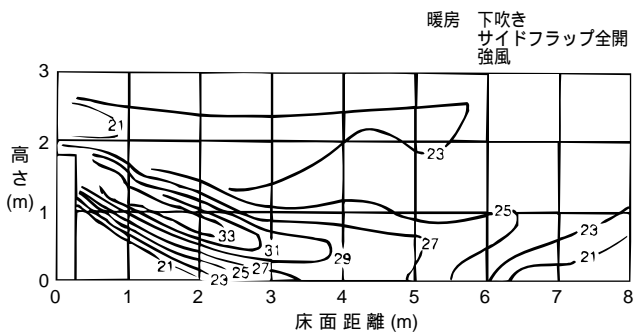
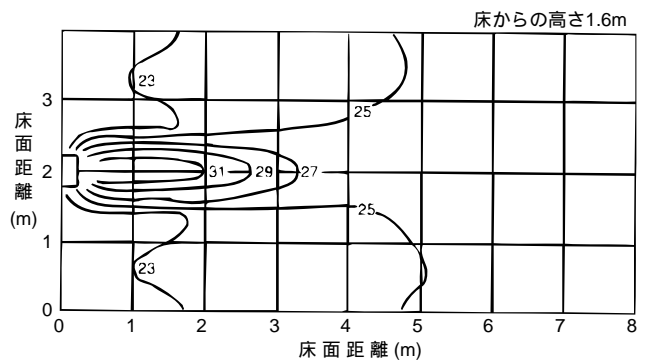
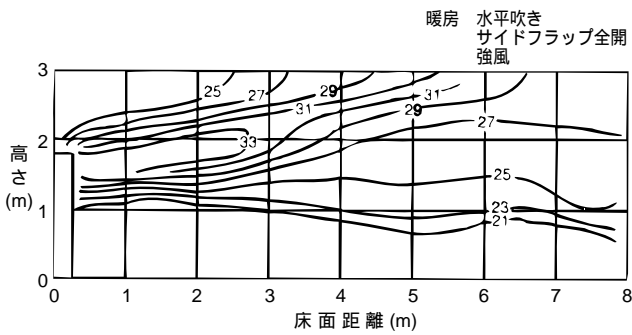
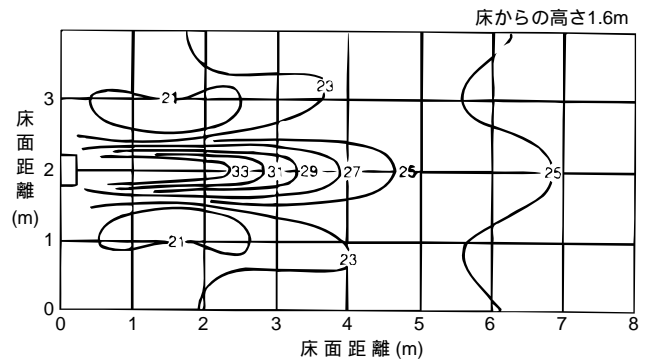
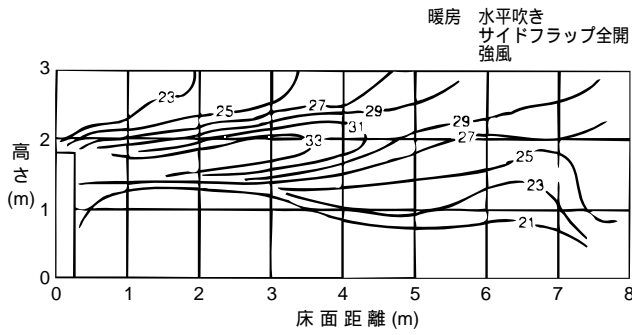

(6) 厨房用エアコン

PCFY-P80HM-E1

[ 冷房・温度分布 ]

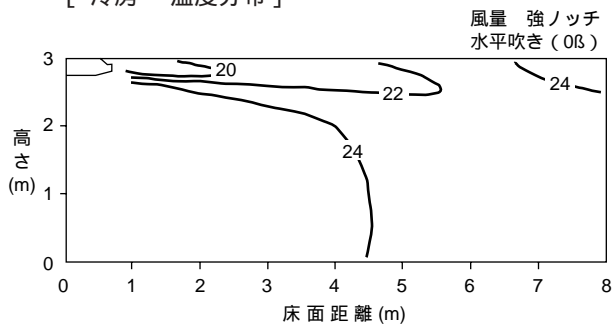

[ 暖房・温度分布 ]

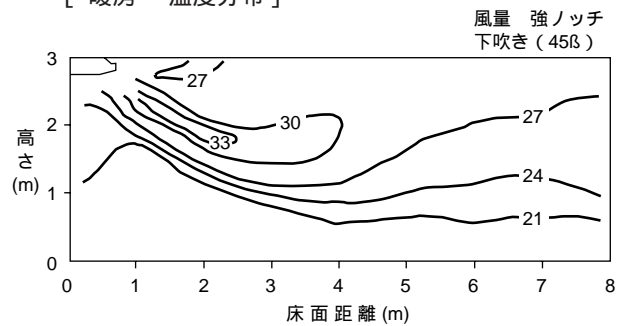

PCFY-P140HM-E1

[ 冷房・温度分布 ]

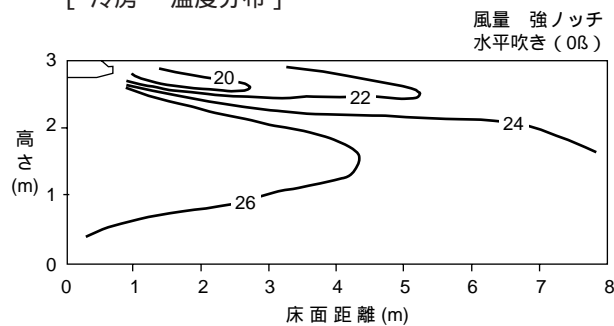

[ 暖房・温度分布 ]

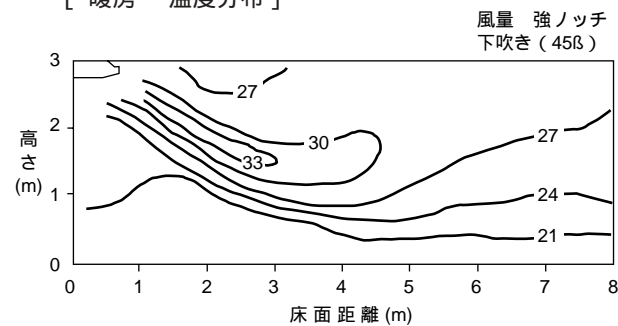

## 7.室内ユニットの騒音

### (1) 騒音レベル

PLFY-AM-E1形

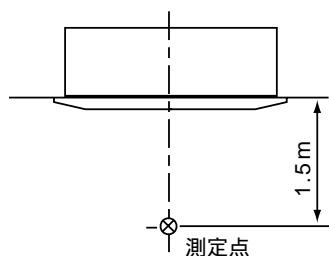

形名	騒音値(dB[A特性])
PLFY-P22・P28AM-E1	30-29-28-27
PLFY-P36AM-E1	31-29-28-27
PLFY-P45・P56AM-E1	32-30-28-27
PLFY-P71AM-E1	33-31-29-28
PLFY-P80AM-E1	34-32-30-28
PLFY-P90AM-E1	37-35-32-30
PLFY-P112AM-E1	40-38-35-32
PLFY-P140AM-E1	44-42-39-36
PLFY-P160AM-E1	44-42-39-36

PLFY-JM-E1形

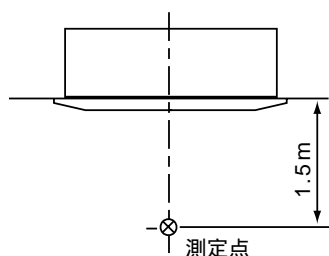

形名	騒音値(dB[A特性])
PLFY-P36・P45JM-E1	35-34-32.5-31
PLFY-P56JM-E1	37-35.5-34-32
PLFY-P71JM-E1	39-38-36.5-35

PLFY-LMD-E1形

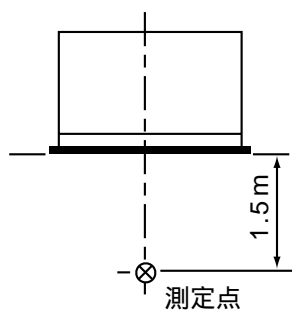

形名	騒音値(dB[A特性])
PLFY-P22・P28 ・P36LMD-E1	31-28-25
PLFY-P45LMD-E1	34-31-27
PLFY-P56LMD-E1	35-32-29
PLFY-P71LMD-E1	37-35-30
PLFY-P80LMD-E1	38-34-30
PLFY-P90LMD-E1	38-35-31
PLFY-P112LMD-E1	40-37-33
PLFY-P140LMD-E1	43-41-39-37

PMFY-EM-E1形

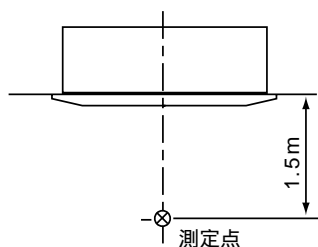

形名	騒音値(dB[A特性])
PMFY-P36・P45EM-E1	39-33/41-33
PMFY-P56EM-E1	39-34/42-34
PMFY-P71・P80EM-E1	42-37/42-37



PMFY-BM-E1形

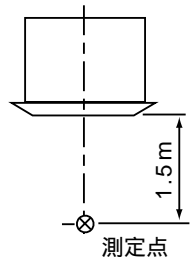

形名	騒音値(dB[A特性])
PMFY-P22BM-E1	35-33-30-27
PMFY-P28・P36BM-E1	37-36-34-32
PMFY-P45BM-E1	39-37-35-33

PDFY-M-E1形

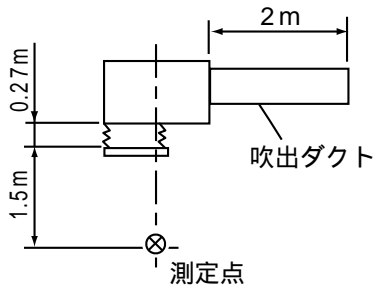

形名	騒音値(dB[A特性])
PDFY-P22・P28・P36M-E1	37-35-33-32
PDFY-P45M-E1	38-36-34-32
PDFY-P56M-E1	39-37-35-33
PDFY-P71M-E1	40-38-36-34
PDFY-P80M-E1	41-39-37-35
PDFY-P90・P112M-E1	41-35
PDFY-P140M-E1	44-38

PEFY-M-E1形

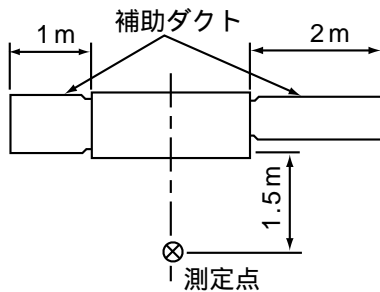

形名	騒音値(dB[A特性])
PEFY-P45M-E1	36-28
PEFY-P56M-E1	36-29
PEFY-P71・P80M-E1	40-33
PEFY-P90M-E1	42-35
PEFY-P112・P140・P160M-E1	43-36
PEFY-P224M-E1	47
PEFY-P280M-E1	50

PEFY-AM-E1形

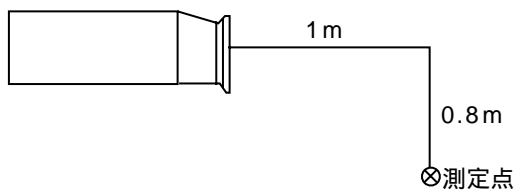

形名	騒音値(dB[A特性])
PEFY-P22・P28AM-E1	40-33
PEFY-P36AM-E1	41-34

PCFY-GM-E1形

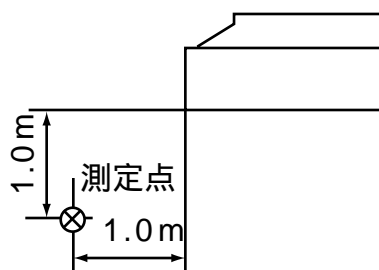

形名	騒音値(dB[A特性])
PCFY-P45GM-E1	38-36-33-29
PCFY-P56GM-E1	39-37-34-29
PCFY-P71・P80GM-E1	39-37-34-32
PCFY-P90・P112GM-E1	43-41-38-36
PCFY-P140GM-E1	44-42-39-37
PCFY-P160GM-E1	46-44-41-39

PKFY-AM-E1形  
 PKFY-AMS-E1形  
 PKFY-GM-E1形

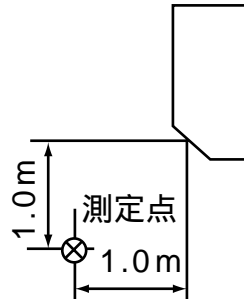

形名	騒音値(dB[A特性])
PKFY-P22・P28AM-E1	36-35-33-32
PKFY-P22・P28AMS-E1	36-35-33-32
PKFY-P36・P45GM-E1	40-38-35-31
PKFY-P56GM-E1	41-39-36-33

PFFY-DM-E1形

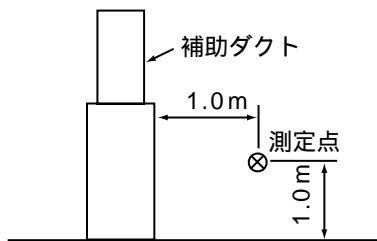

形名	騒音値(dB[A特性])
PFFY-P224DM-E1	53/53
PFFY-P280DM-E1	55/55
PFFY-P450DM-E1	53/55
PFFY-P560DM-E1	57/60

PFFY-LRM-E1形

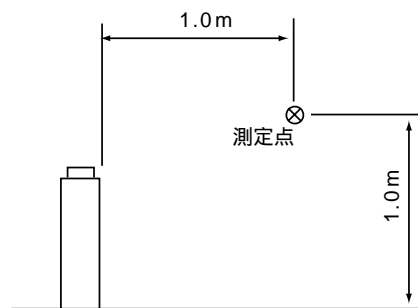

形名	騒音値(dB[A特性])
PFFY-P28・P36LRM-E1	37-31
PFFY-P45LRM-E1	40-34
PFFY-P56LRM-E1	42-37
PFFY-P71LRM-E1	44-38

PFFY-LEM-E1形

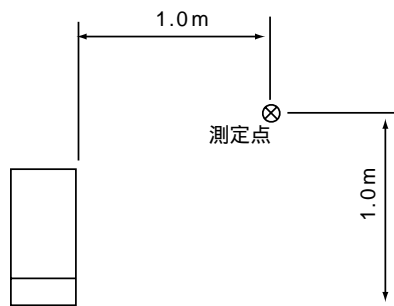

形名	騒音値(dB[A特性])
PFFY-P28・P36LEM-E1	37-31
PFFY-P45LEM-E1	40-34
PFFY-P56LEM-E1	42-37
PFFY-P71LEM-E1	44-38

PSFY-GM-E1形

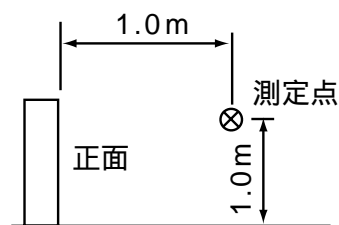

形名	騒音値(dB[A特性])
PSFY-P56GM-E1	38-33
PSFY-P71GM-E1	40-35
PSFY-P80GM-E1	42-37
PSFY-P112GM-E1	48-42
PSFY-P140GM-E1	49-43
PSFY-P160GM-E1	52-46

PFFY-RM-E1形

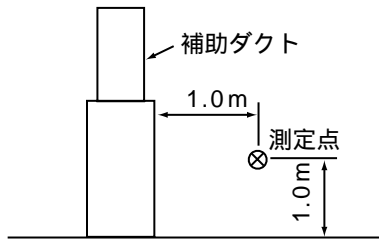

形名	騒音値(dB[A特性])
PFFY-P112RM-E1	47/48
PFFY-P140RM-E1	49/50
PFFY-P224RM-E1	52.5
PFFY-P280RM-E1	55

PEFY-ML-E(-R)形

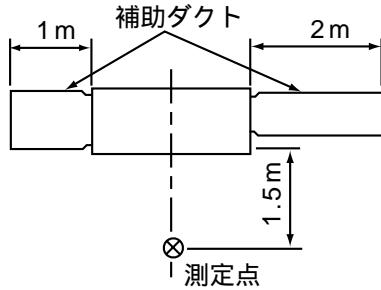

形名	騒音値(dB[A特性])
PEFY-P22・28ML-E(-R)	30-25-20

PCFY-HM-E1形

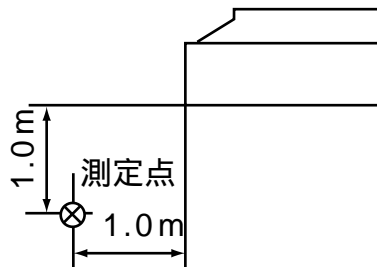

形名	騒音値(dB[A特性])
PCFY-P80HM-E1	38-32
PCFY-P140HM-E1	50-44

PEFY-M-E1-F形

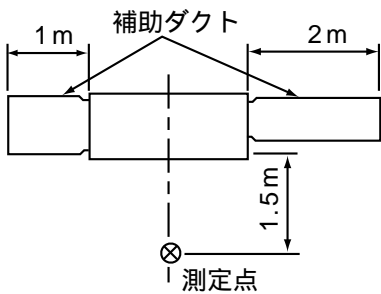

形名	騒音値(dB[A特性])
PEFY-P90M-E1-F	36
PEFY-P112・P140M-E1-F	36
PEFY-P160M-E1-F	37
PEFY-P224M-E1-F	42
PEFY-P280M-E1-F	43

PFFY-RM-E1-F形

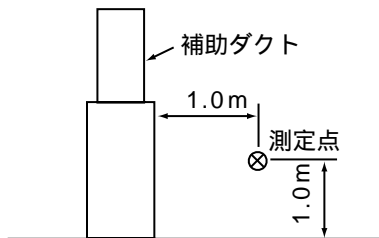

形名	騒音値(dB[A特性])
PFFY-P280RM-E1-F	48

PLFY-CLMD-E1形

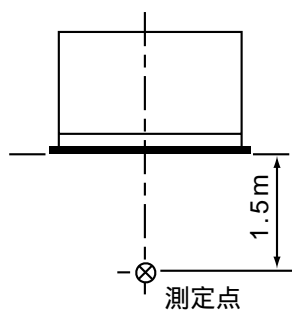

形名	騒音値(dB[A特性])
PLFY-P36CLMD-E1	39-37
PLFY-P45CLMD-E1	40-38.5
PLFY-P56CLMD-E1	40-38.5
PLFY-P71CLMD-E1	42-39
PLFY-P80CLMD-E1	42-39

## (2) NC曲線

### PLFY-P22・28AM-E1形

	63Hz	125Hz	250Hz	500Hz	1000Hz	2000Hz	4000Hz	8000Hz	A特性計算
強ノッチ	40.2	34.1	32.6	28.0	25.4	17.8	7.9	1.9	30
中1ノッチ	39.7	33.0	31.2	26.7	23.5	15.8	7.3	2.0	29
中2ノッチ	38.6	33.0	30.2	26.0	21.8	14.3	7.1	2.1	28
弱ノッチ	38.7	32.6	29.5	25.5	20.4	13.4	7.3	3.3	27

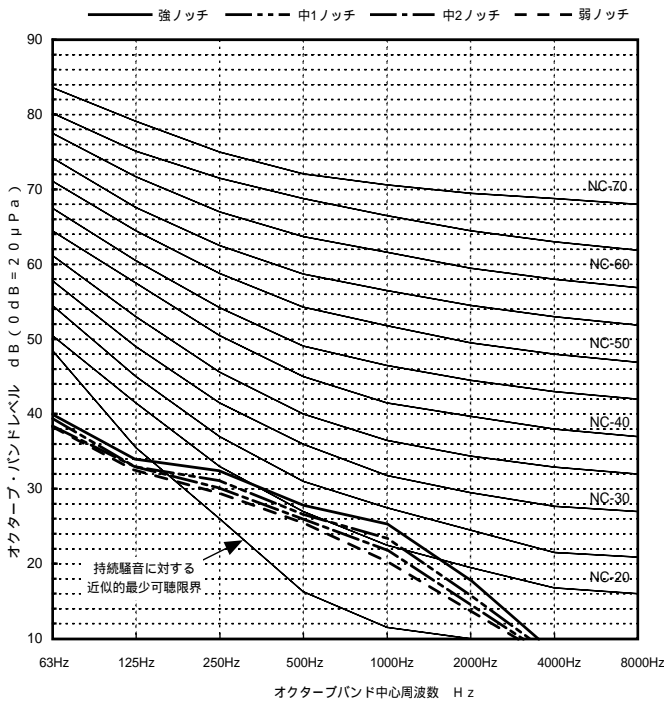

### PLFY-P36AM-E1形

	63Hz	125Hz	250Hz	500Hz	1000Hz	2000Hz	4000Hz	8000Hz	A特性計算
強ノッチ	40.9	34.8	33.3	28.7	26.1	18.5	8.6	2.6	31
中1ノッチ	39.9	33.2	31.4	26.9	23.7	16.0	7.5	2.2	29
中2ノッチ	38.8	33.2	30.4	26.2	22.0	14.5	7.3	2.3	28
弱ノッチ	38.7	32.6	29.5	25.5	20.4	13.4	7.3	3.3	27

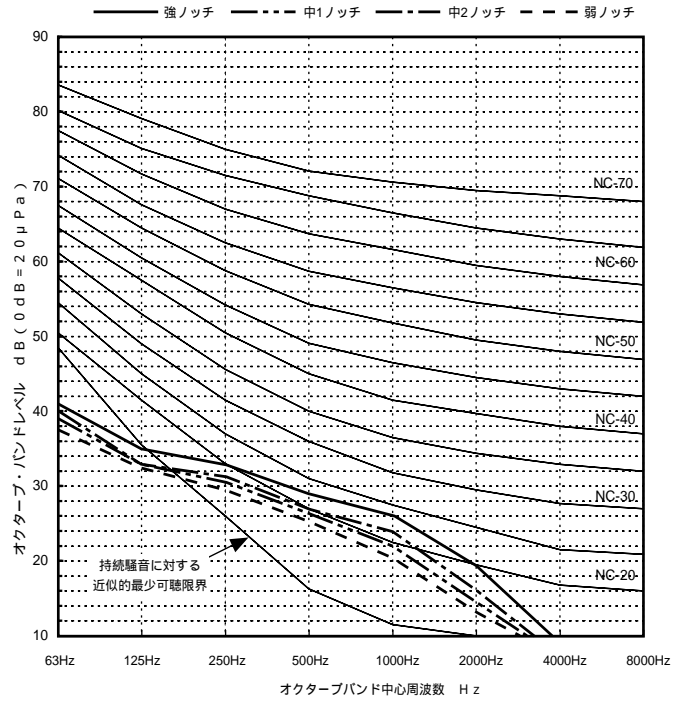

### PLFY-P45・56AM-E1形

	63Hz	125Hz	250Hz	500Hz	1000Hz	2000Hz	4000Hz	8000Hz	A特性計算
強ノッチ	41.9	35.8	34.3	29.7	27.1	19.5	9.6	3.6	32
中1ノッチ	40.9	34.2	32.4	27.9	24.7	17.0	8.5	3.2	30
中2ノッチ	38.8	33.2	30.4	26.2	22.0	14.5	7.3	2.3	28
弱ノッチ	38.7	32.6	29.5	25.5	20.4	13.4	7.3	3.3	27

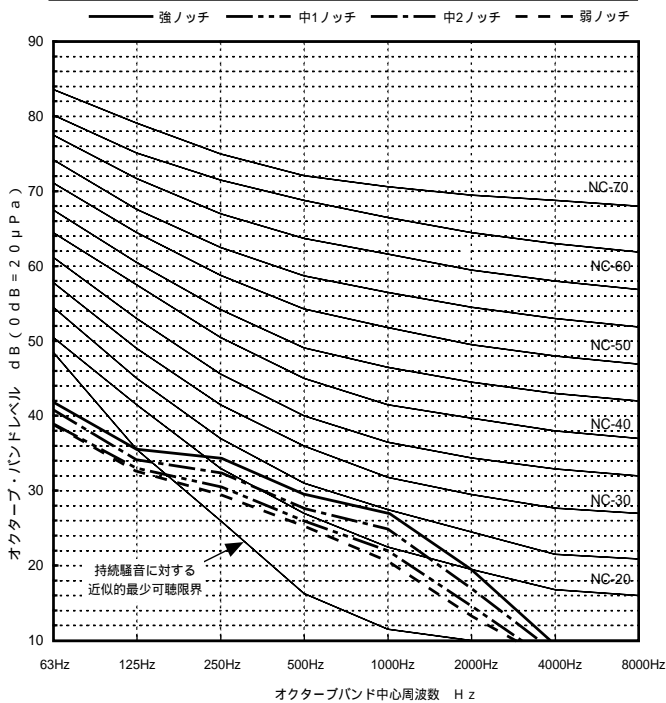

### PLFY-P71AM-E1形

	63Hz	125Hz	250Hz	500Hz	1000Hz	2000Hz	4000Hz	8000Hz	A特性計算
強ノッチ	38.9	36.0	34.6	30.3	28.7	22.0	10.7	1.9	33
中1ノッチ	38.1	35.3	32.9	29.3	26.5	19.3	9.2	2.5	31
中2ノッチ	37.7	34.0	30.8	27.2	23.7	16.2	7.7	2.6	29
弱ノッチ	37.5	33.8	29.7	26.8	21.7	14.8	7.6	2.3	28

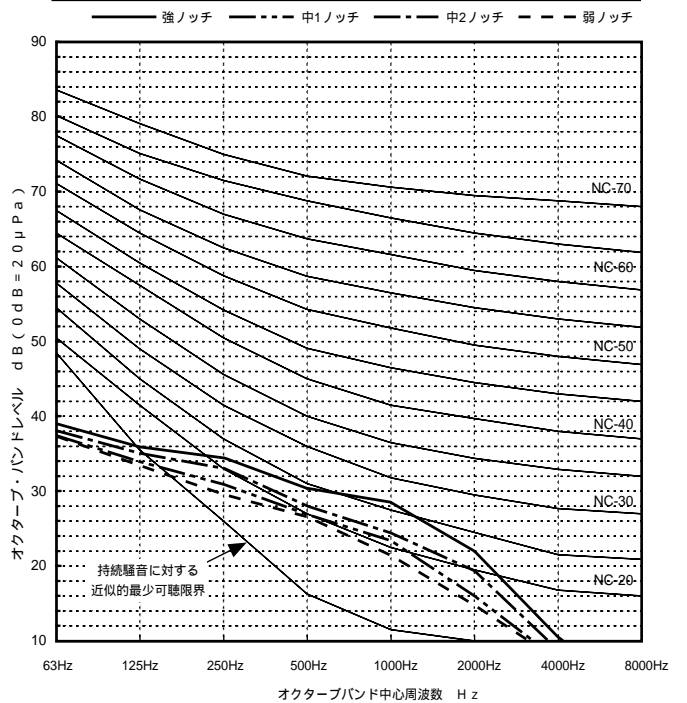

### PLFY-P80AM-E1形

	63Hz	125Hz	250Hz	500Hz	1000Hz	2000Hz	4000Hz	8000Hz	A特性計算
強ノッチ	39.9	37.0	35.6	31.3	29.7	23.0	11.7	2.9	34
中1ノッチ	39.1	36.3	33.9	29.3	27.5	20.3	10.2	3.5	32
中2ノッチ	38.7	35.0	31.8	28.2	24.7	17.2	8.7	3.6	30
弱ノッチ	37.5	33.8	29.7	26.8	21.7	14.8	7.6	2.3	28

—— 強ノッチ    - - - - 中1ノッチ    - - - - 中2ノッチ    - - - - 弱ノッチ

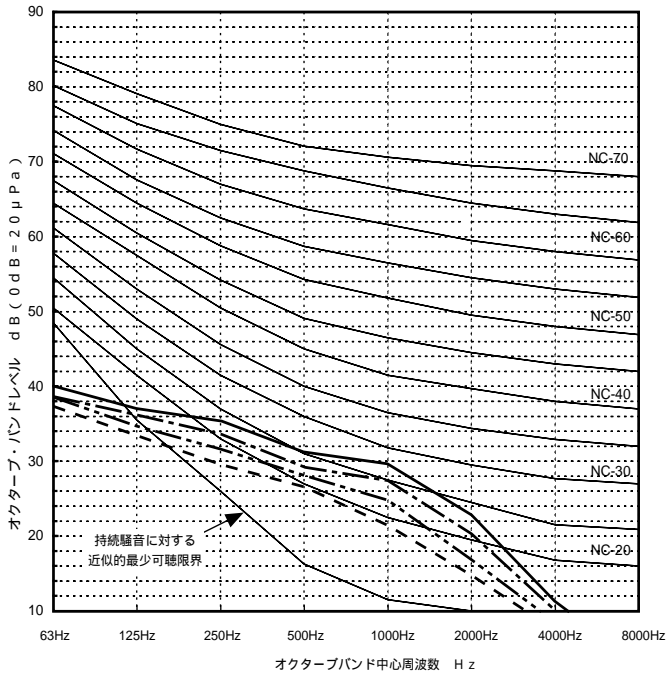

### PLFY-P90AM-E1形

	63Hz	125Hz	250Hz	500Hz	1000Hz	2000Hz	4000Hz	8000Hz	A特性計算
強ノッチ	42.9	40.0	38.6	34.3	32.7	26.0	14.7	5.9	37
中1ノッチ	42.1	39.3	36.9	32.3	30.5	23.3	13.2	6.5	35
中2ノッチ	40.7	37.0	33.8	30.2	26.7	19.2	10.7	5.6	32
弱ノッチ	39.5	35.8	31.7	28.8	23.7	16.8	9.6	4.3	30

—— 強ノッチ    - - - - 中1ノッチ    - - - - 中2ノッチ    - - - - 弱ノッチ

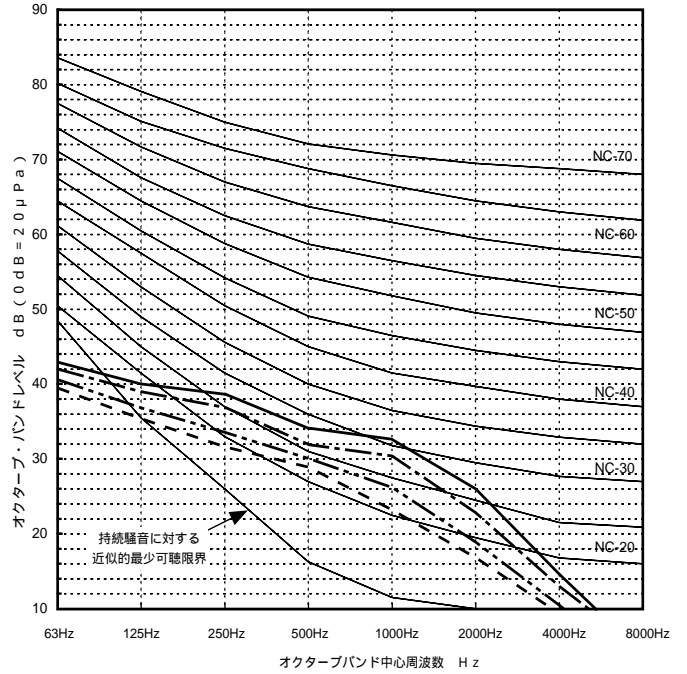

### PLFY-P112AM-E1形

	63Hz	125Hz	250Hz	500Hz	1000Hz	2000Hz	4000Hz	8000Hz	A特性計算
強ノッチ	48.2	42.4	41.8	36.5	35.6	29.5	23.9	9.9	40
中1ノッチ	42.1	41.1	40.2	34.6	33.5	27.1	20.6	7.0	38
中2ノッチ	35.7	36.8	37.5	32.3	30.6	23.2	15.6	3.3	35
弱ノッチ	33.5	34.4	34.5	29.7	27.5	19.2	11.4	1.8	32

—— 強ノッチ    - - - - 中1ノッチ    - - - - 中2ノッチ    - - - - 弱ノッチ

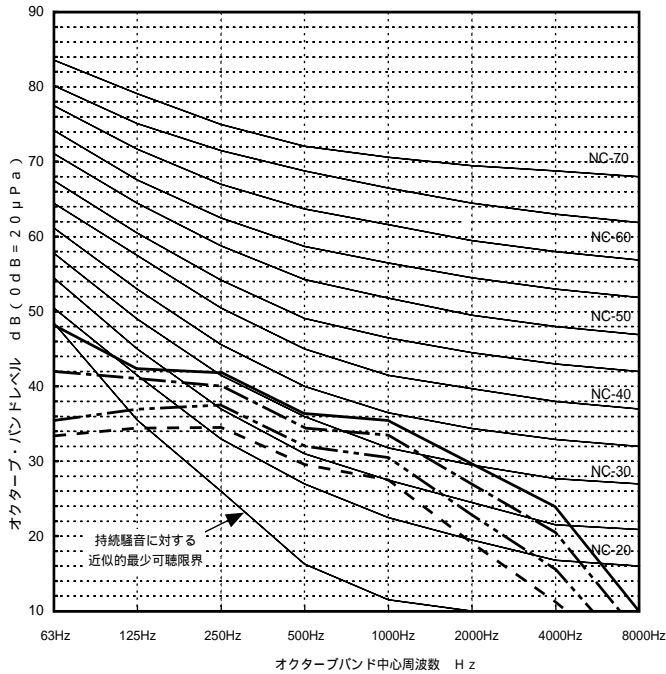

### PLFY-P140・160AM-E1形

	63Hz	125Hz	250Hz	500Hz	1000Hz	2000Hz	4000Hz	8000Hz	A特性計算
強ノッチ	51.1	47.3	46.2	39.6	39.6	33.9	28.4	14.3	44
中1ノッチ	46.0	45.1	45.1	38.3	36.8	31.9	25.1	11.0	42
中2ノッチ	43.6	43.5	41.8	35.6	34.1	28.3	19.5	6.8	39
弱ノッチ	40.6	40.4	38.9	33.3	30.7	24.1	14.3	5.0	36

—— 強ノッチ    - - - - 中1ノッチ    - - - - 中2ノッチ    - - - - 弱ノッチ

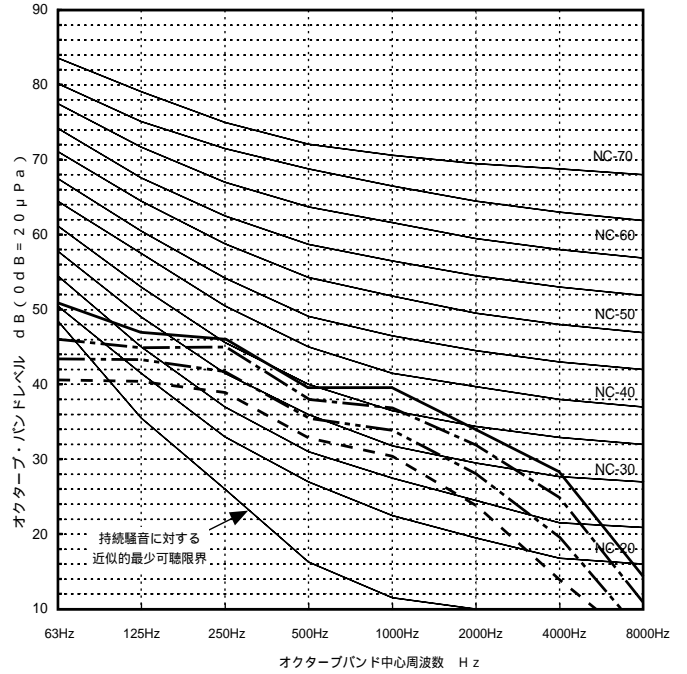

### PLFY-P36・45JM-E1形

	63Hz	125Hz	250Hz	500Hz	1000Hz	2000Hz	4000Hz	8000Hz	A特性計算
強ノッチ	31.5	32.3	34.0	33.8	30.0	26.2	18.0	11.0	35.0
中1ノッチ	30.9	31.9	33.1	32.8	28.8	25.1	17.0	11.0	34.0
中2ノッチ	29.7	31.0	31.8	31.4	27.1	23.5	15.4	10.4	32.5
弱ノッチ	28.7	30.2	30.5	30.0	25.5	22.0	14.0	10.0	31.0

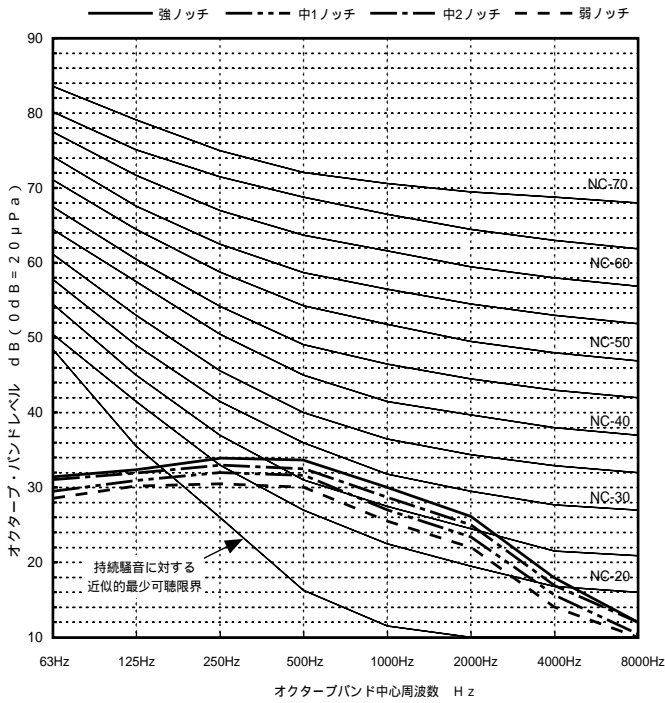

### PLFY-P56JM-E1形

	63Hz	125Hz	250Hz	500Hz	1000Hz	2000Hz	4000Hz	8000Hz	A特性計算
強ノッチ	33.0	34.3	36.3	35.8	31.8	28.2	20.2	14.0	37.0
中1ノッチ	31.8	33.6	34.9	34.4	30.2	26.7	18.3	12.9	35.5
中2ノッチ	30.6	32.9	33.3	33.0	28.5	25.0	16.4	11.6	34.0
弱ノッチ	29.0	31.7	31.4	31.1	26.4	23.0	14.0	10.0	32.0

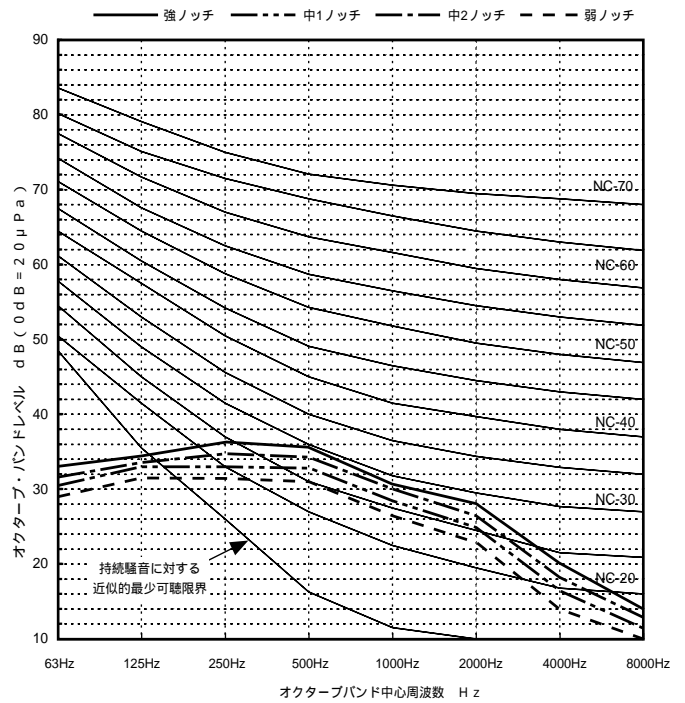

### PLFY-P71JM-E1形

	63Hz	125Hz	250Hz	500Hz	1000Hz	2000Hz	4000Hz	8000Hz	A特性計算
強ノッチ	36.0	36.8	38.8	38.1	34.1	31.5	22.4	15.0	39.0
中1ノッチ	34.6	36.1	37.3	36.8	32.5	29.7	19.8	13.7	38.0
中2ノッチ	33.2	35.4	35.9	35.5	31.0	27.8	17.3	12.3	36.5
弱ノッチ	31.8	34.7	34.4	34.2	29.4	26.0	14.7	11.0	35.0

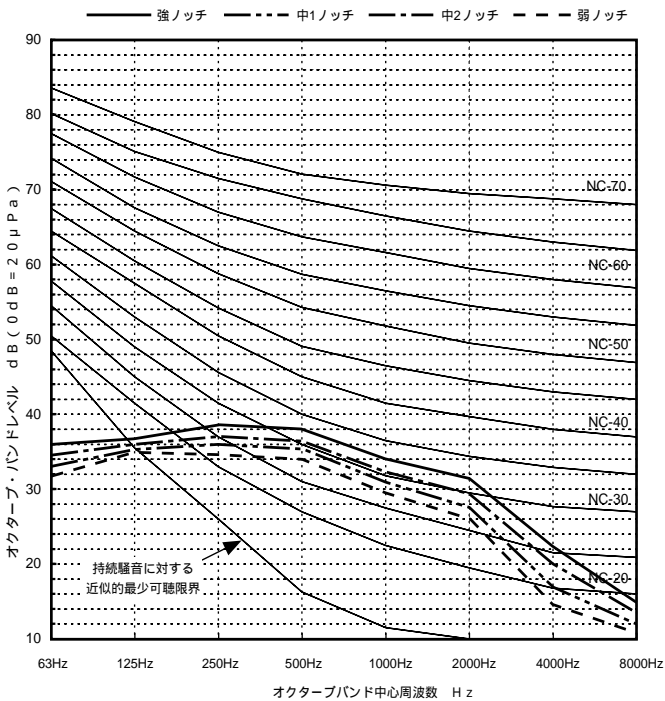

### PLFY-P22・28LMD-E1形

	63Hz	125Hz	250Hz	500Hz	1000Hz	2000Hz	4000Hz	8000Hz	A特性計算
強ノッチ	35	34	34.5	30	24	16.5	13	13.5	31
中ノッチ	34.5	32	32	26.5	20	14.5	12.5	13	28
弱ノッチ	34	30	28	22.5	17	13	12	12.5	25

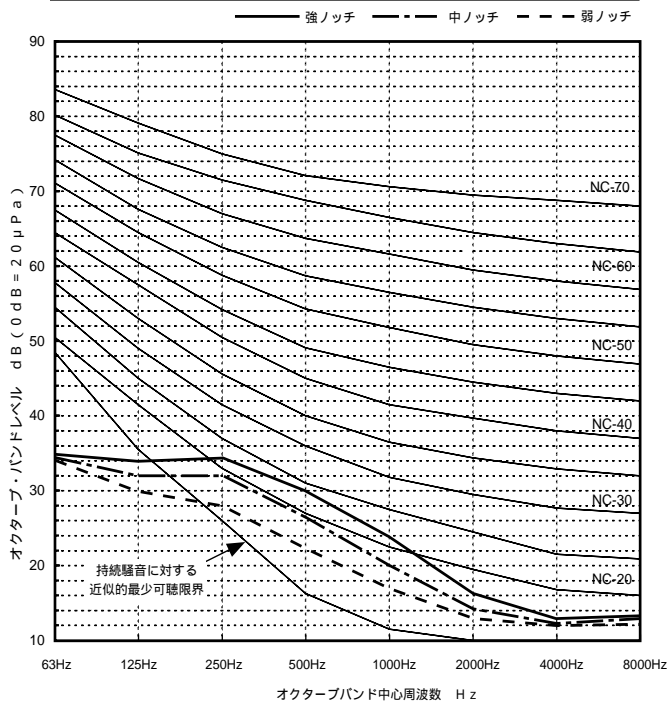

### PLFY-P36LMD-E1形

	63Hz	125Hz	250Hz	500Hz	1000Hz	2000Hz	4000Hz	8000Hz	A特性計算
強ノッチ	31	33.5	34	29.5	24	20.5	12.5	12	31
中ノッチ	30	32.5	32	26	20	16	12	11.5	28
弱ノッチ	26	31	29	22	17	13	11.5	11	25

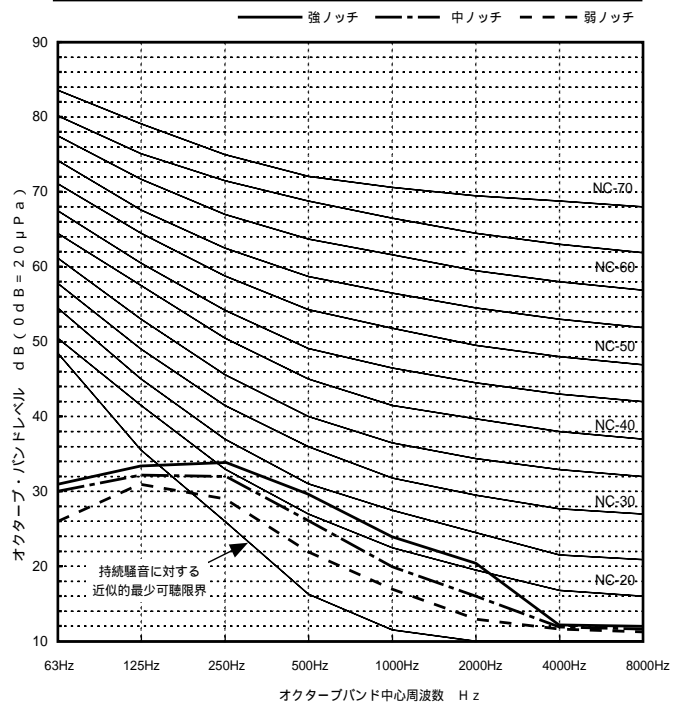

### PLFY-P45LMD-E1形

	63Hz	125Hz	250Hz	500Hz	1000Hz	2000Hz	4000Hz	8000Hz	A特性計算
強ノッチ	32	35.5	37	32	27.5	24.5	16.5	12.5	34
中ノッチ	31	33	34.5	29	24	20.5	14	12	31
弱ノッチ	30	30	30.5	24.5	20	17	12.5	11.5	27

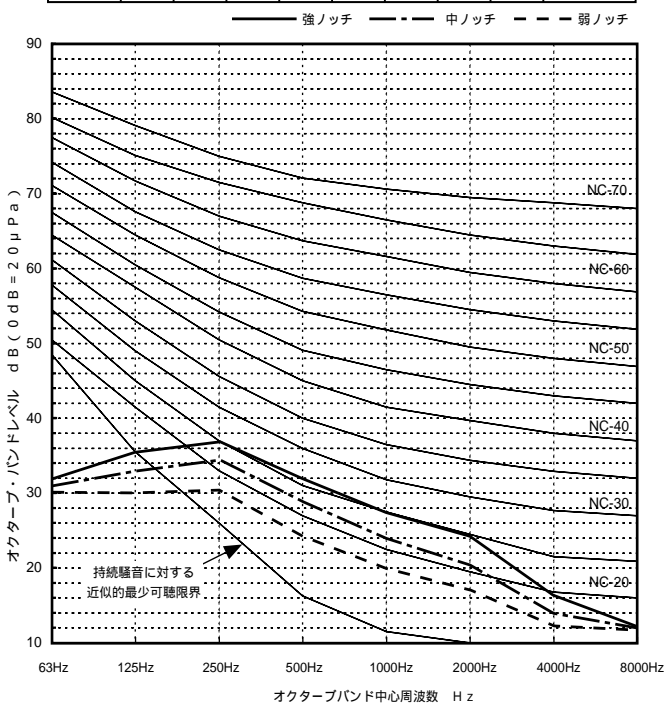

### PLFY-P56LMD-E1形

	63Hz	125Hz	250Hz	500Hz	1000Hz	2000Hz	4000Hz	8000Hz	A特性計算
強ノッチ	35	36.5	37	33.5	30	21.5	13.5	11	35
中ノッチ	34	34	34.5	30.5	27	17.5	12	10.5	32
弱ノッチ	33	33	31.5	28	23	14	10.5	10	29

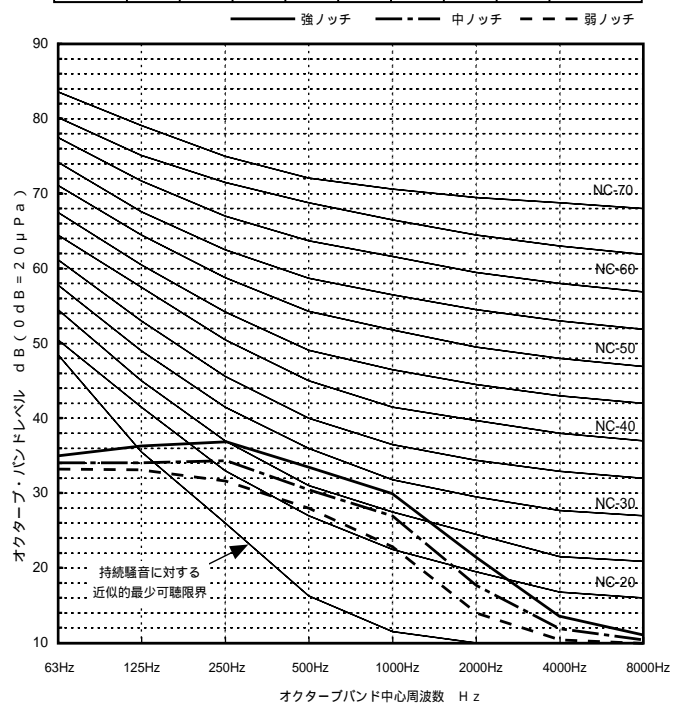

### PLFY-P71LMD-E1形

	63Hz	125Hz	250Hz	500Hz	1000Hz	2000Hz	4000Hz	8000Hz	A特性計算
強ノッチ	36	39.5	40	34.5	32.5	24	13	11	37
中ノッチ	33.5	36.5	38.5	33	30	20	12	10.5	35
弱ノッチ	32.5	34	34	28	24	15	11	10	30

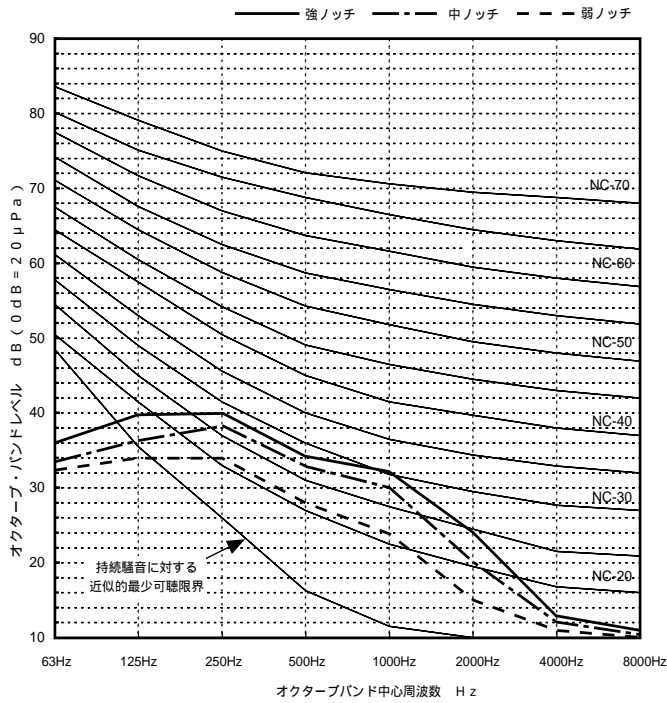

### PLFY-P80LMD-E1形

	63Hz	125Hz	250Hz	500Hz	1000Hz	2000Hz	4000Hz	8000Hz	A特性計算
強ノッチ	38	41.5	38	36.5	33.5	26.5	18	14.5	38
中ノッチ	33.5	37.5	35.5	32.5	29	21.5	15.5	13	34
弱ノッチ	31	35.5	31.5	29	24	16	13	11.5	30

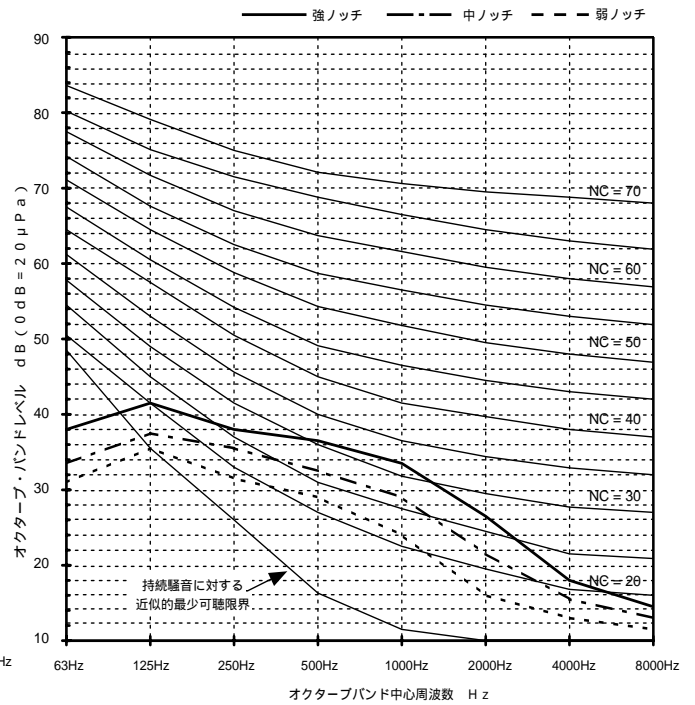

### PLFY-P90LMD-E1形

	63Hz	125Hz	250Hz	500Hz	1000Hz	2000Hz	4000Hz	8000Hz	A特性計算
強ノッチ	38	41.5	38.5	37	32.5	27	18.5	16	38
中ノッチ	33.5	36	36.5	34	30	22	15.5	14	35
弱ノッチ	31	32	31.5	29	25	15	12.5	12	30

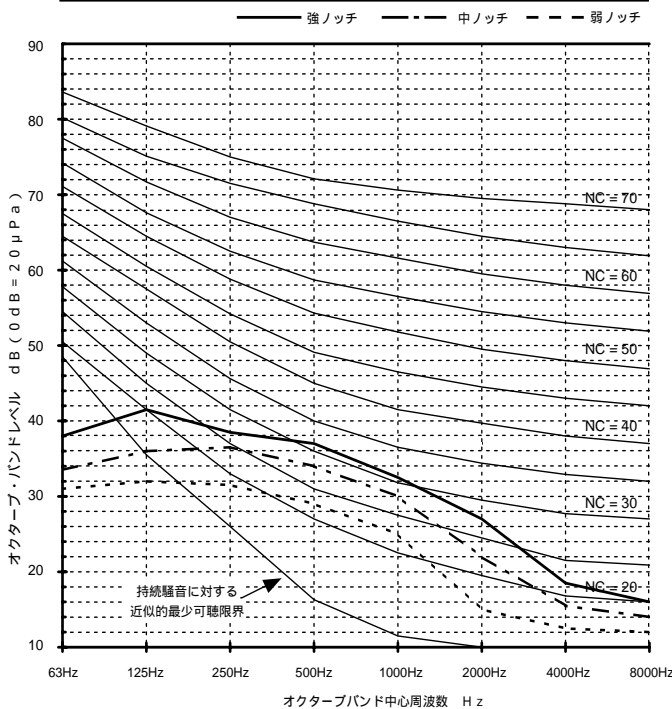

### PLFY-P112LMD-E1形

	63Hz	125Hz	250Hz	500Hz	1000Hz	2000Hz	4000Hz	8000Hz	A特性計算
強ノッチ	36.5	41.5	41	38.5	33.5	28	19	13.5	40
中ノッチ	36	38	37.5	36	32.5	23.5	16	13	37
弱ノッチ	33.5	36.5	34.5	32	27.5	19.5	13.6	12.5	33

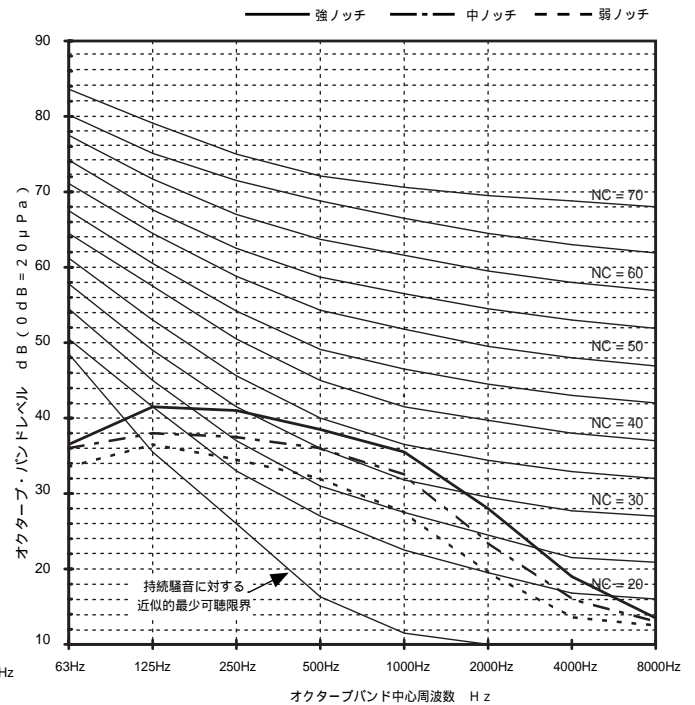



### PLFY-P140LMD-E1形

	63Hz	125Hz	250Hz	500Hz	1000Hz	2000Hz	4000Hz	8000Hz	A特性計算
強ノッチ	40.5	42	44.5	42	37	33	24	16	43
弱ノッチ	35	36	38	37	30.5	24.5	19	15	37

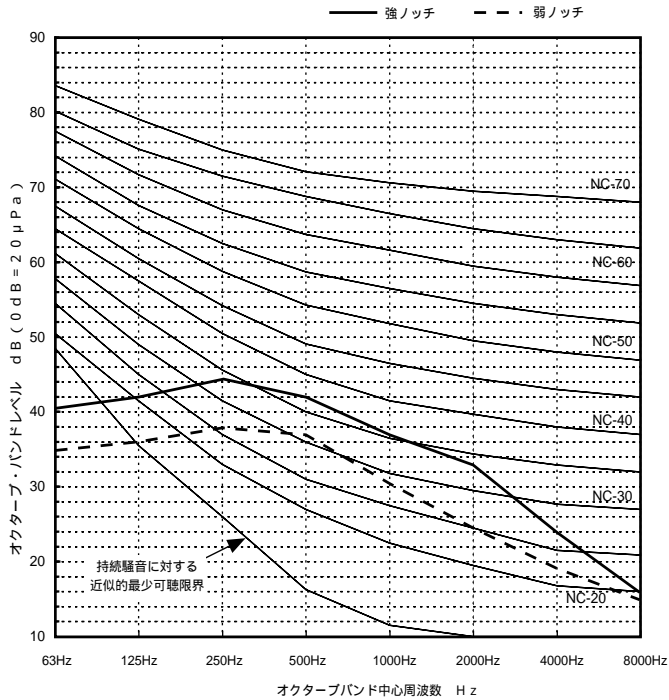

### PMFY-P22BM-E1形

	63Hz	125Hz	250Hz	500Hz	1000Hz	2000Hz	4000Hz	8000Hz	A特性計算
強ノッチ	33.2	25.8	32.5	30.3	32.7	25.8	16.0	4.7	35
中1ノッチ	31.2	23.8	30.5	28.3	30.7	23.8	14.0	2.7	33
中2ノッチ	28.2	20.8	27.5	25.3	27.7	20.8	11.0	-0.3	30
弱ノッチ	25.2	17.8	24.5	22.3	24.7	17.8	8.0	-3.3	27

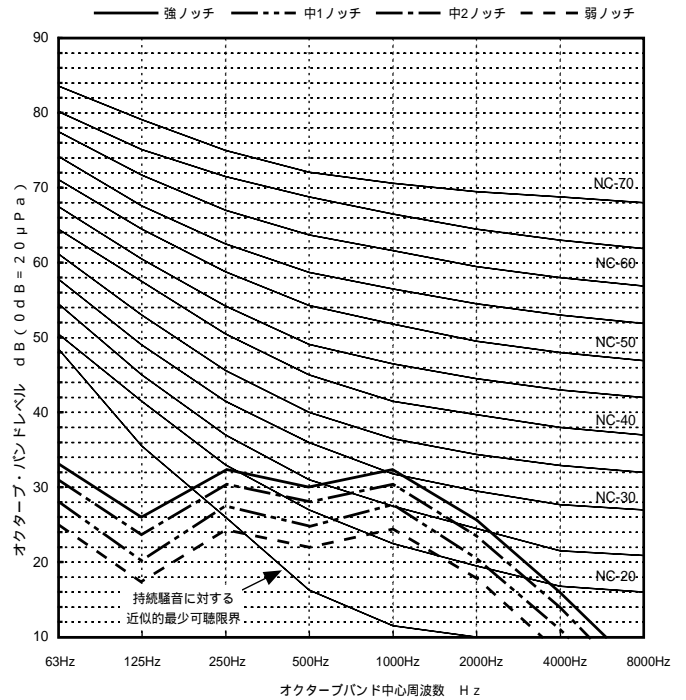

### PMFY-P28・36BM-E1形

	63Hz	125Hz	250Hz	500Hz	1000Hz	2000Hz	4000Hz	8000Hz	A特性計算
強ノッチ	35.2	27.8	34.5	32.3	34.7	27.8	18.0	6.7	37
中1ノッチ	34.2	26.8	33.5	31.3	33.7	26.8	17.0	5.7	36
中2ノッチ	32.2	24.8	31.5	29.3	31.7	24.8	15.0	3.7	34
弱ノッチ	30.2	22.8	29.5	27.3	29.7	22.8	13.0	1.7	32

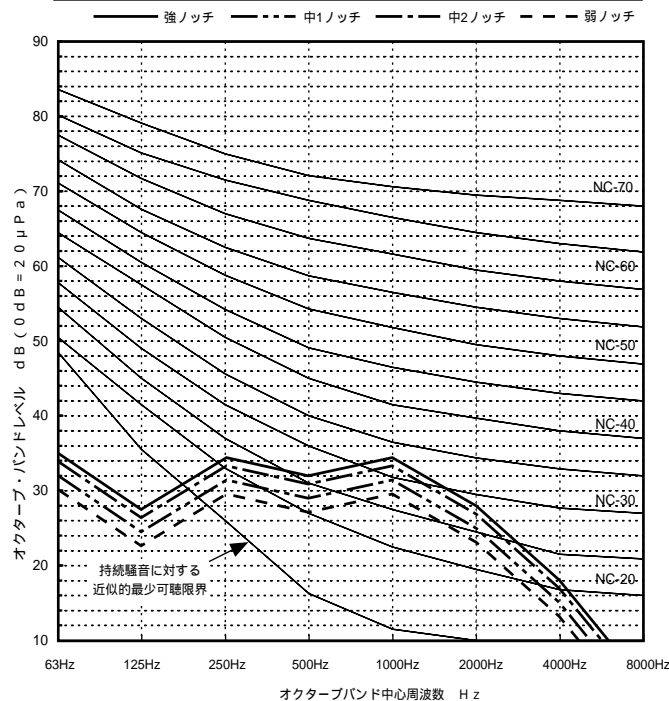

### PMFY-P45BM-E1形

	63Hz	125Hz	250Hz	500Hz	1000Hz	2000Hz	4000Hz	8000Hz	A特性計算
強ノッチ	37.2	29.8	36.5	34.3	36.7	29.8	20.0	8.7	39
中1ノッチ	35.2	27.8	34.5	32.3	34.7	27.8	18.0	6.7	37
中2ノッチ	33.2	25.8	32.5	30.3	32.7	25.8	16.0	4.7	35
弱ノッチ	31.2	23.8	30.5	28.3	30.7	23.8	14.0	2.7	33

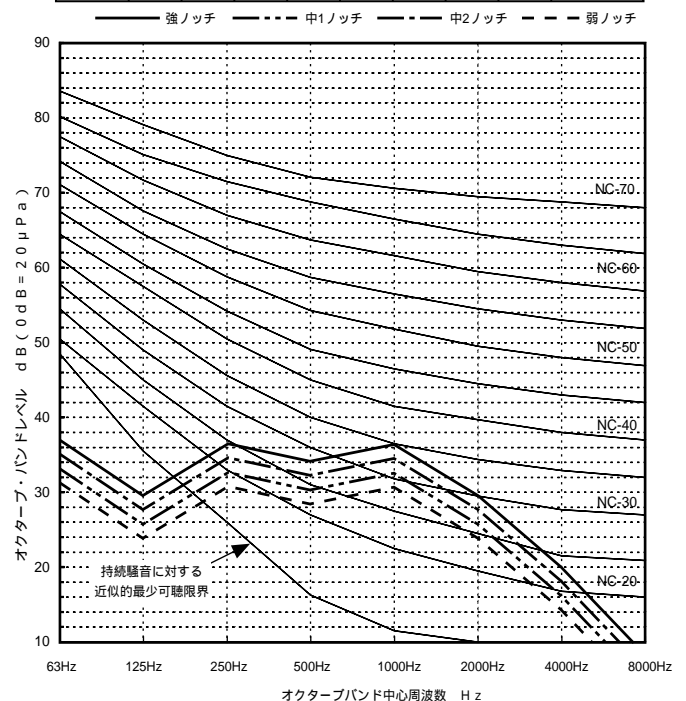

### PMFY-P36・45EM-E1形

	63Hz	125Hz	250Hz	500Hz	1000Hz	2000Hz	4000Hz	8000Hz	A特性計算
強ノッチ(50Hz)	28.5	37.0	39.5	37.0	34.5	30.0	22.0	15.0	39
強ノッチ(60Hz)	29.0	38.5	41.0	38.5	37.0	32.5	25.5	18.0	41
弱ノッチ(50Hz)	24.0	31.0	33.5	31.5	28.0	23.0	14.5	7.0	33
弱ノッチ(60Hz)	23.5	31.0	34.0	31.5	28.0	23.5	14.0	7.0	33

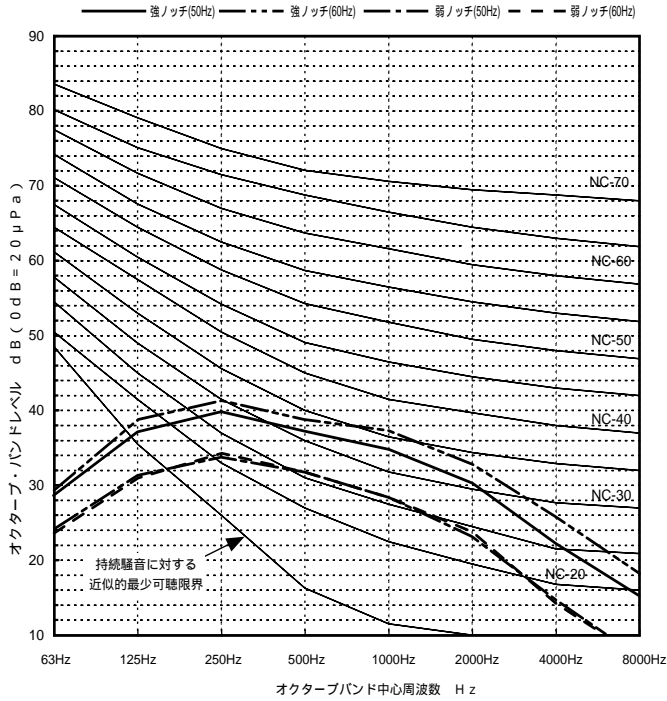

### PMFY-P56EM-E1形

	63Hz	125Hz	250Hz	500Hz	1000Hz	2000Hz	4000Hz	8000Hz	A特性計算
強ノッチ(50Hz)	28.5	37.0	39.5	37.0	34.5	30.0	22.0	15.0	39
強ノッチ(60Hz)	30.0	39.5	42.0	39.5	38.0	33.5	26.5	19.0	42
弱ノッチ(50Hz)	25.0	32.0	34.5	32.5	29.0	24.0	15.5	8.0	34
弱ノッチ(60Hz)	24.5	32.0	35.0	32.5	29.0	24.5	15.0	8.0	34

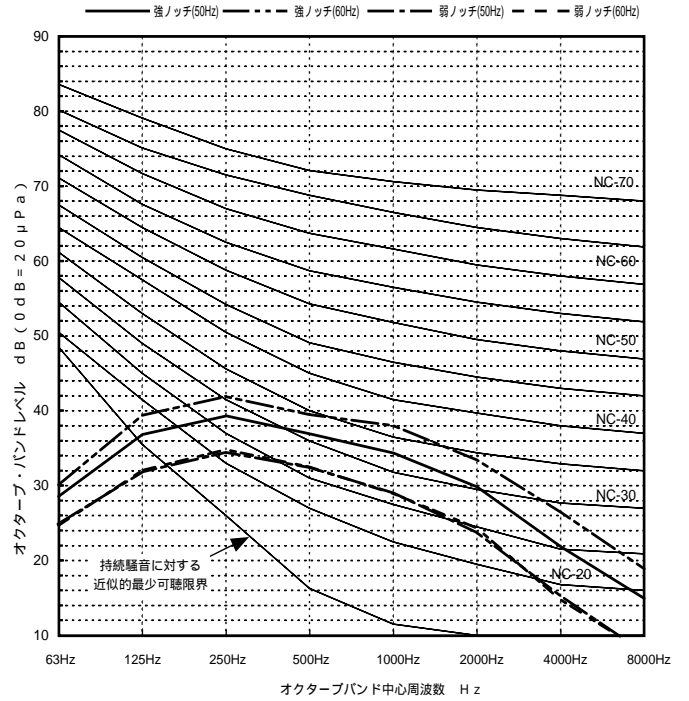

### PMFY-P71・80EM-E1形

	63Hz	125Hz	250Hz	500Hz	1000Hz	2000Hz	4000Hz	8000Hz	A特性計算
強ノッチ(50Hz)	30.0	40.5	42.5	40.0	37.5	32.5	25.5	19.0	42
強ノッチ(60Hz)	31.0	41.0	44.0	42.0	39.0	35.5	29.0	22.0	44
弱ノッチ(50Hz)	27.5	37.5	38.0	35.5	32.0	26.5	20.0	13.5	37
弱ノッチ(60Hz)	26.5	36.0	38.5	35.5	32.0	26.5	19.0	13.0	37

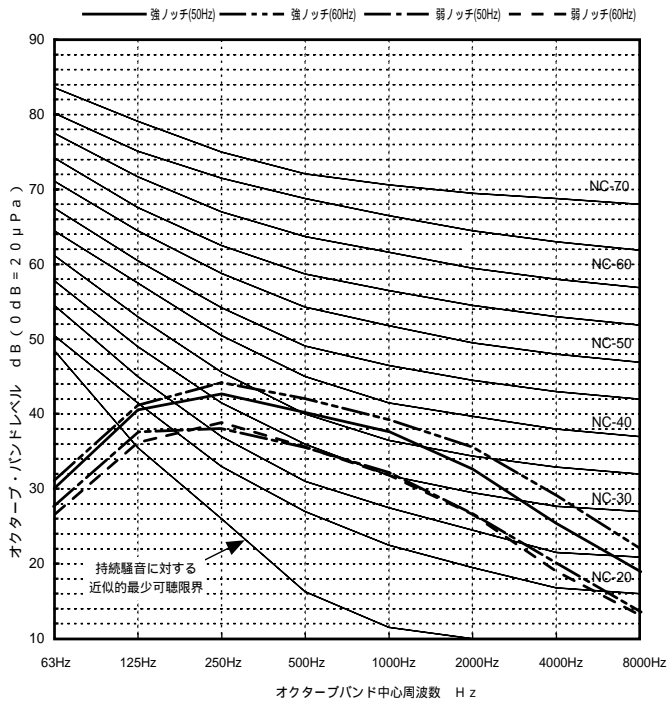

PDFY-P22・P28・P36M-E1形

	63Hz	125Hz	250Hz	500Hz	1000Hz	2000Hz	4000Hz	8000Hz	A特性計算
強ノッチ	41	43	40	33	32	27	16	10	37
弱ノッチ	37	38	36	28	26	20	14	10	32

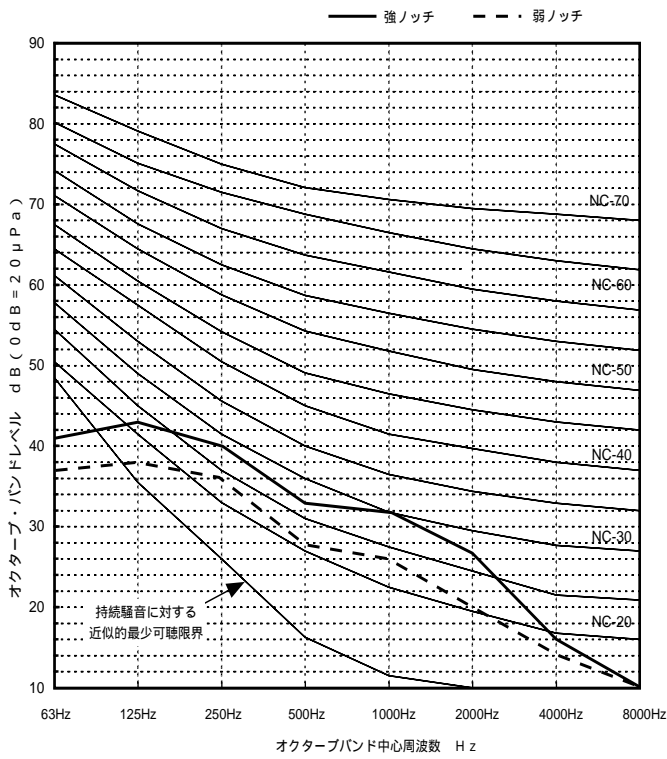

PDFY-P45M-E1形

	63Hz	125Hz	250Hz	500Hz	1000Hz	2000Hz	4000Hz	8000Hz	A特性計算
強ノッチ	42	44	42	35	32	26	14	10	38
弱ノッチ	39	40	35	29	26	19	13	10	32

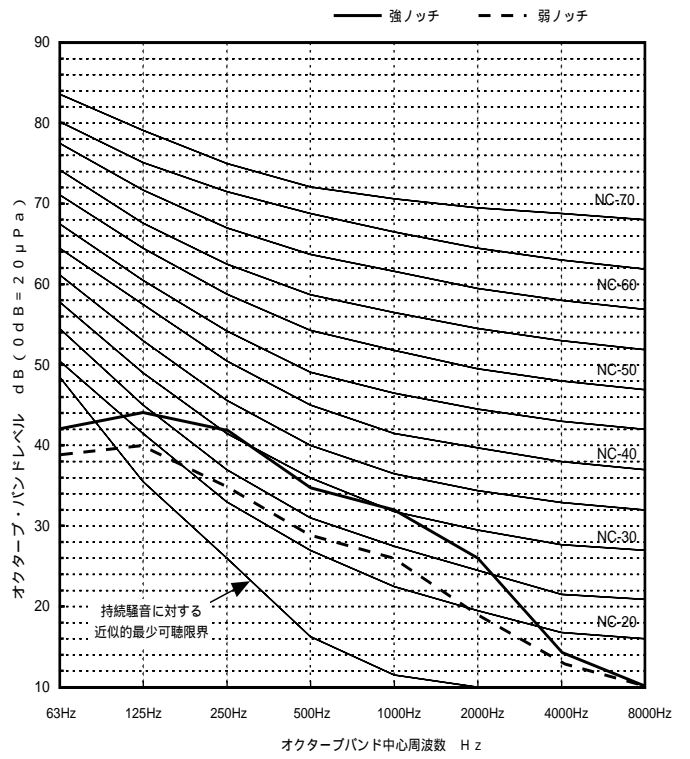

PDFY-P56M-E1形

	63Hz	125Hz	250Hz	500Hz	1000Hz	2000Hz	4000Hz	8000Hz	A特性計算
強ノッチ	43	45	43	36	34	27	14	10	39
弱ノッチ	40	41	36	30	26	22	14	10	33

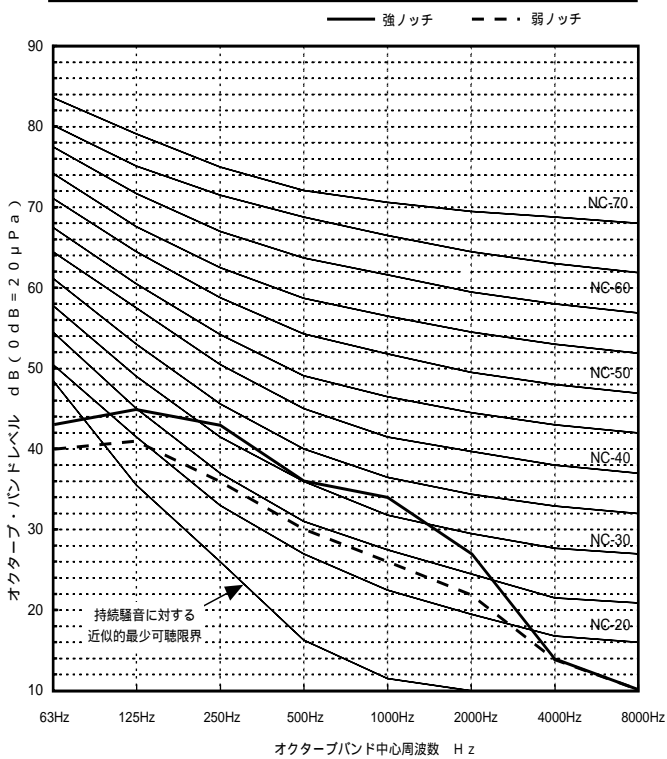

PDFY-P71M-E1形

	63Hz	125Hz	250Hz	500Hz	1000Hz	2000Hz	4000Hz	8000Hz	A特性計算
強ノッチ	45	46	41	39	34	28	16	10	40
弱ノッチ	40	41	36	33	27	20	16	10	34

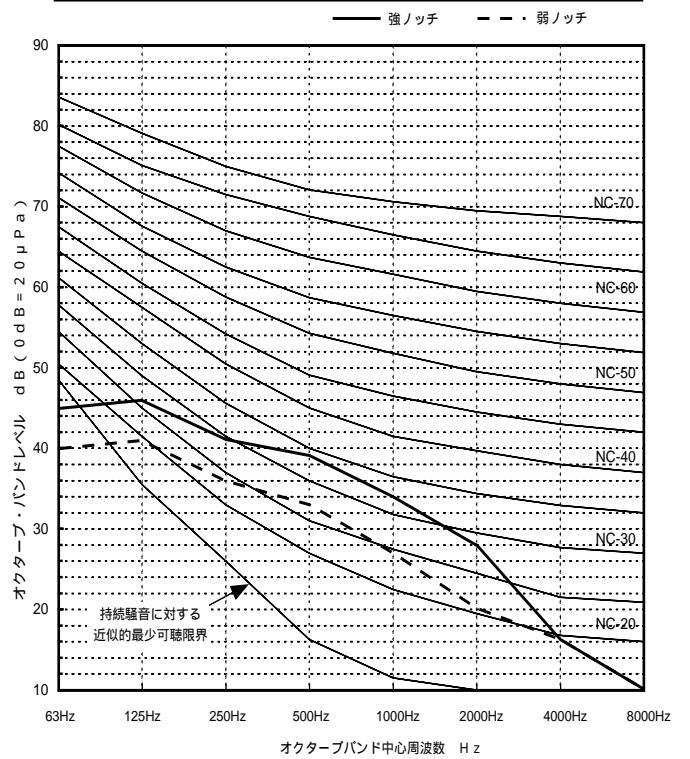

### PDFY-P80M-E1形

	63Hz	125Hz	250Hz	500Hz	1000Hz	2000Hz	4000Hz	8000Hz	A特性計算
強ノッチ	46	48	43	40	34	28	16	10	41
弱ノッチ	40	42	36	34	29	21	15	10	35

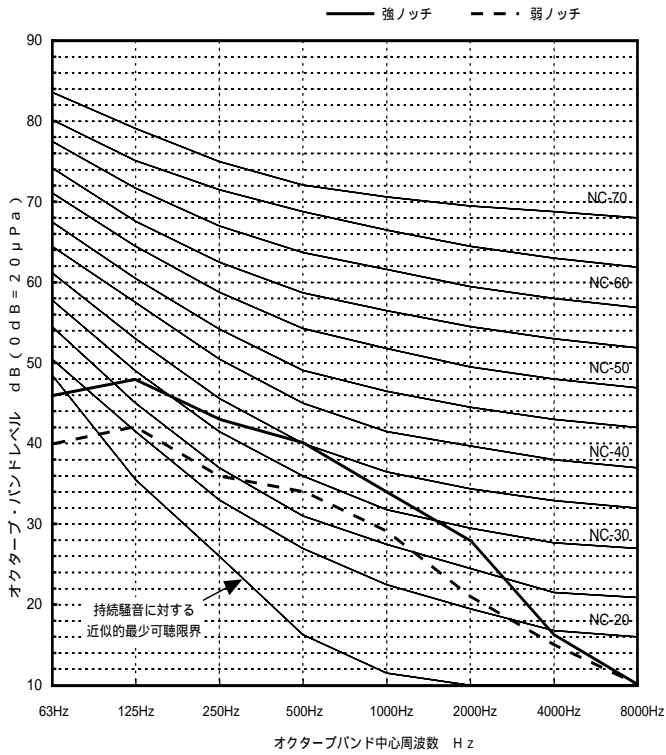

### PDFY-P90M-E1形

	63Hz	125Hz	250Hz	500Hz	1000Hz	2000Hz	4000Hz	8000Hz	A特性計算
強ノッチ	45	47	43	39	36	27	20	11	41
弱ノッチ	41	42	37	33	29	23	16	10	35

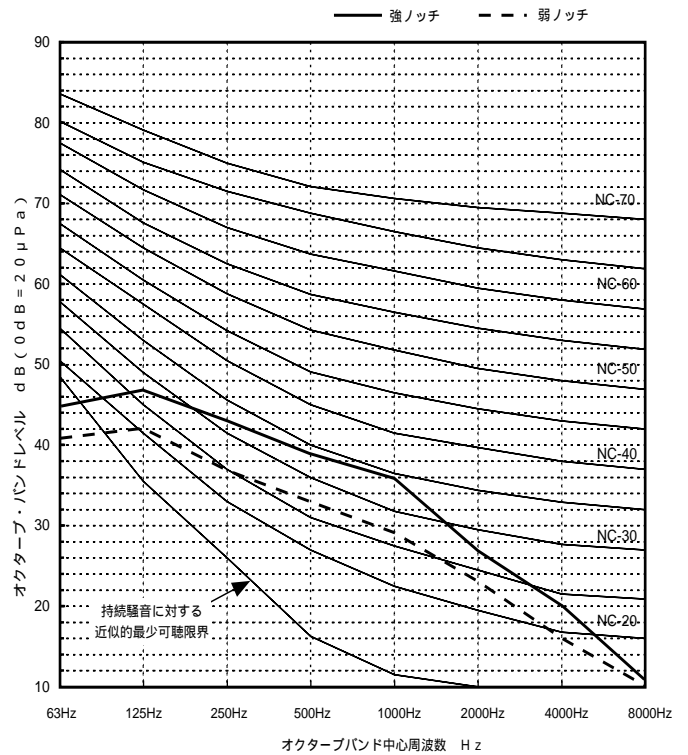

### PDFY-P112M-E1形

	63Hz	125Hz	250Hz	500Hz	1000Hz	2000Hz	4000Hz	8000Hz	A特性計算
強ノッチ	46	48	42	38	35	32	26	22	41
弱ノッチ	43	42	34	33	28	26	22	19	35

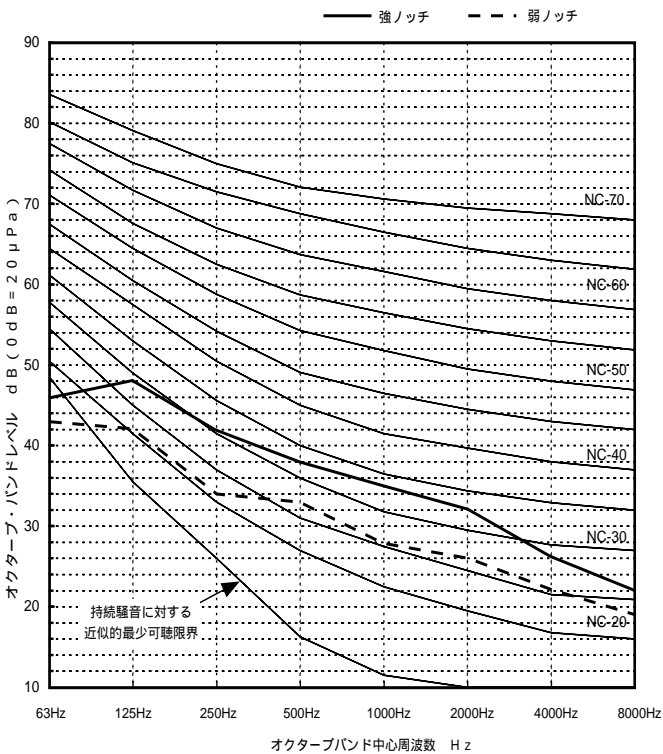

### PDFY-P140M-E1形

	63Hz	125Hz	250Hz	500Hz	1000Hz	2000Hz	4000Hz	8000Hz	A特性計算
強ノッチ	49	50	47	40	38	35	27	21	44
弱ノッチ	48	46	38	36	31	29	19	12	38

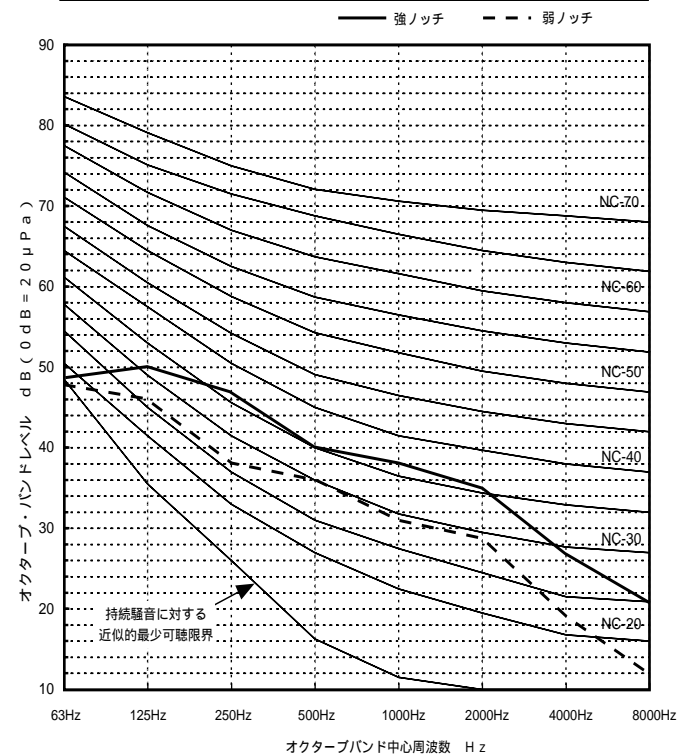

### PEFY-P22・28AM-E1形

	63Hz	125Hz	250Hz	500Hz	1000Hz	2000Hz	4000Hz	8000Hz	A特性計算
強ノッチ	38.5	40	37	38	36.5	29.5	20		40
弱ノッチ	31.5	33	30	31	29.5	22.5	13		33

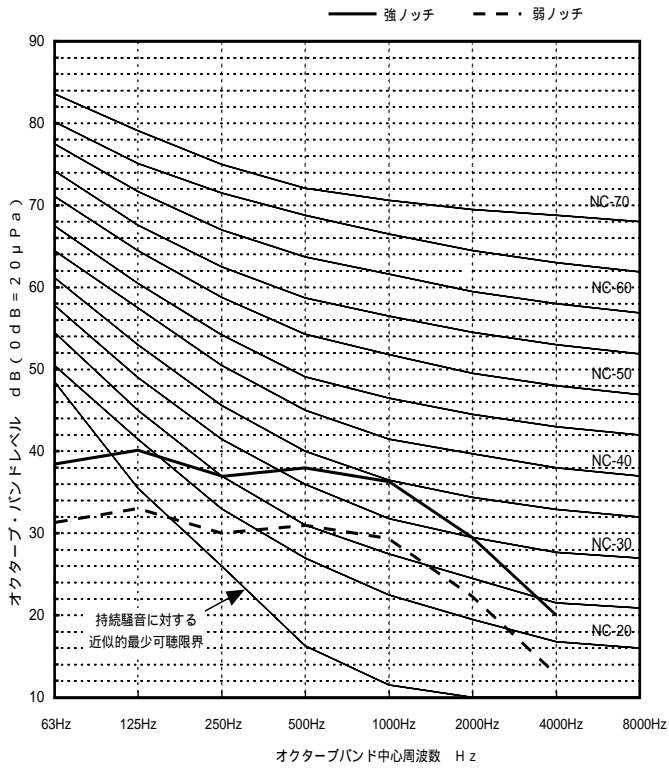

### PEFY-P36AM-E1形

	63Hz	125Hz	250Hz	500Hz	1000Hz	2000Hz	4000Hz	8000Hz	A特性計算
強ノッチ	39.5	41	38	39.5	37.5	30.5	21		41
弱ノッチ	32.5	34	31	32.5	30.5	23.5	14		34

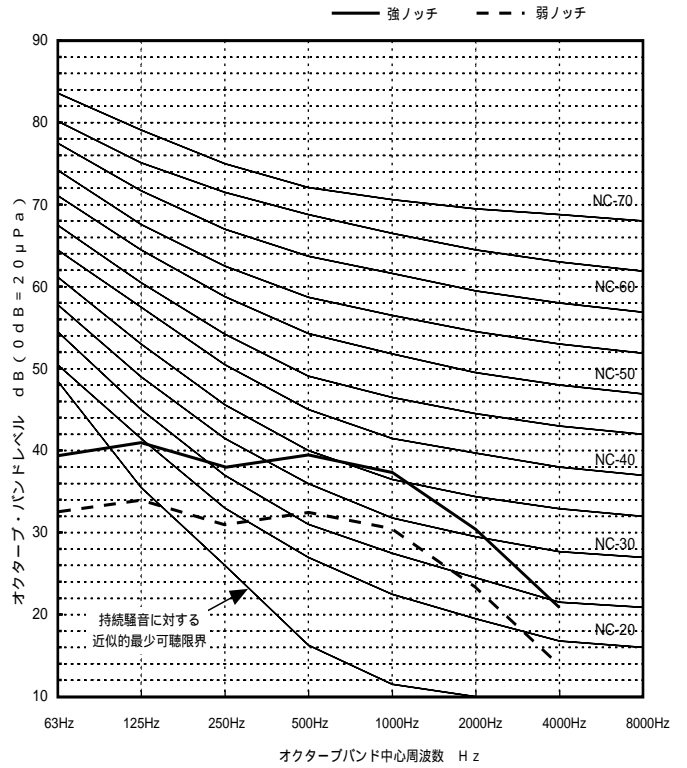

### PEFY-P45M-E1形

	63Hz	125Hz	250Hz	500Hz	1000Hz	2000Hz	4000Hz	8000Hz	A特性計算
強ノッチ	44	44	37	33	30	26	20	14	36
弱ノッチ	40	36	28	25	21.5	18	14	12	28

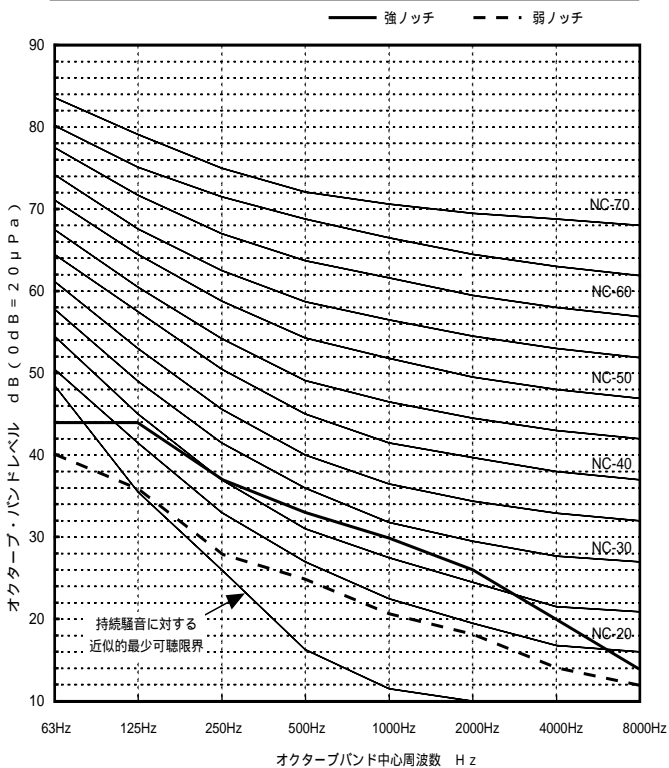

### PEFY-P56M-E1形

	63Hz	125Hz	250Hz	500Hz	1000Hz	2000Hz	4000Hz	8000Hz	A特性計算
強ノッチ	44	43	37	32.5	31	26	20	14	36
弱ノッチ	39	37	29	26	23	19	14	12	29

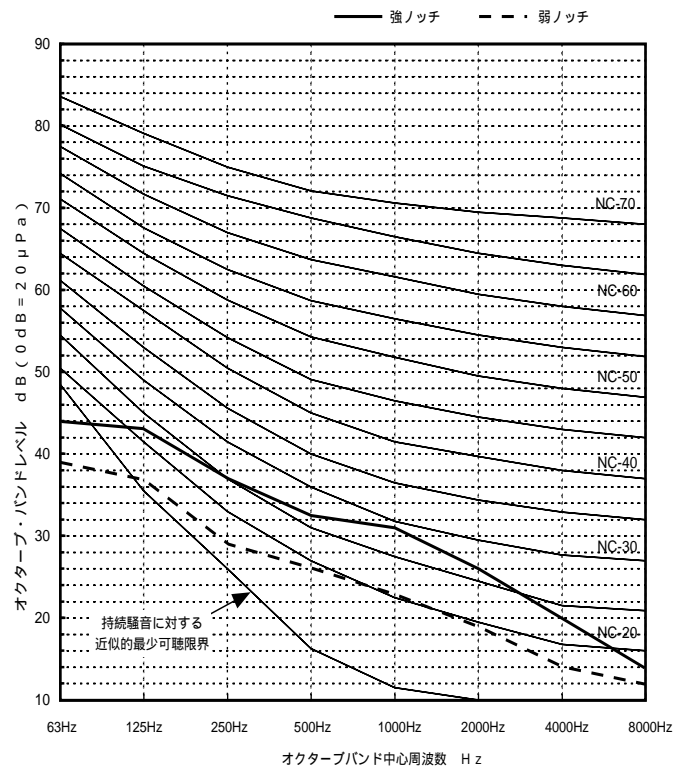

### PEFY-P71M-E1形

	63Hz	125Hz	250Hz	500Hz	1000Hz	2000Hz	4000Hz	8000Hz	A特性計算
強ノッチ	46	45	41	37	36	28	23	16	40
弱ノッチ	40	39	32	30	29	22	16	14	33

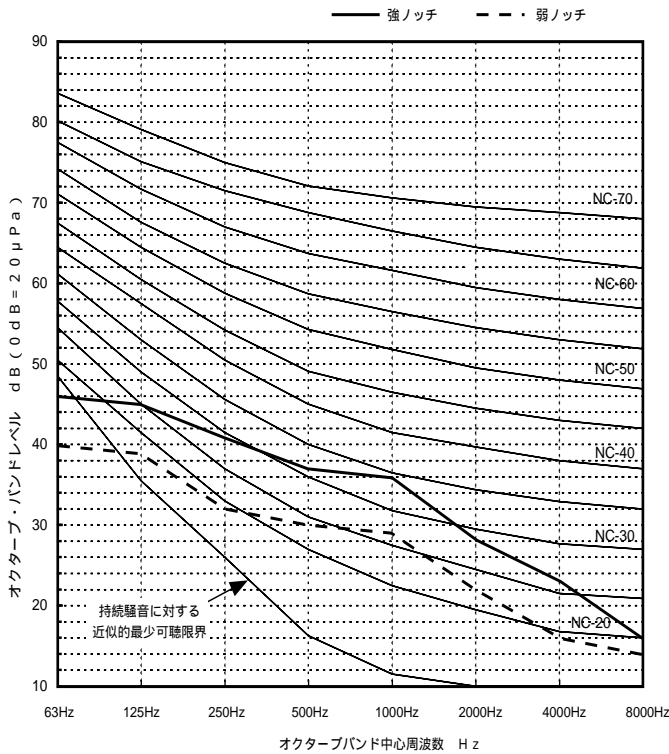

### PEFY-P80M-E1形

	63Hz	125Hz	250Hz	500Hz	1000Hz	2000Hz	4000Hz	8000Hz	A特性計算
強ノッチ	47	50	42	35	34	28	23	17	40
弱ノッチ	43	44	34	29	26	20	16	14	33

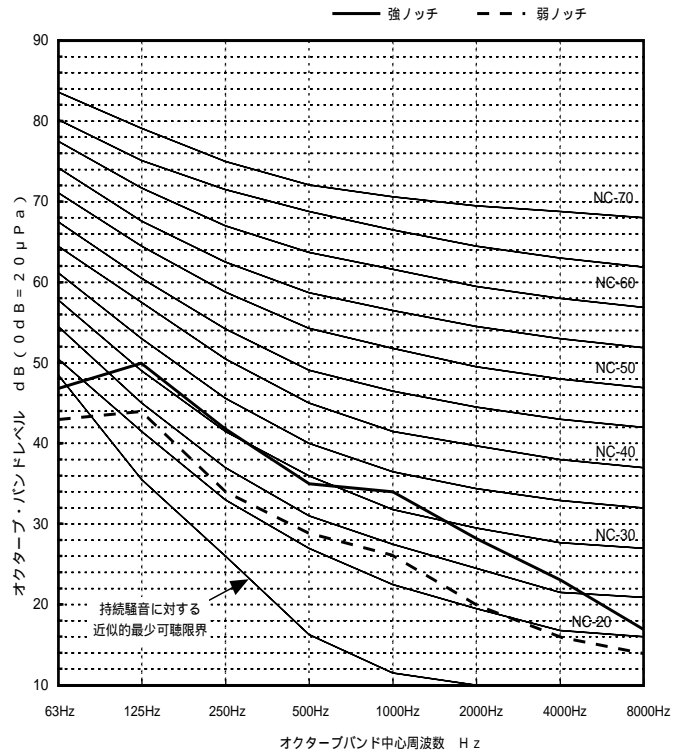

### PEFY-P90M-E1形

	63Hz	125Hz	250Hz	500Hz	1000Hz	2000Hz	4000Hz	8000Hz	A特性計算
強ノッチ	49	51	45	39	35	28	24	17	42
弱ノッチ	44	46	37	32	27	20	17	12	35

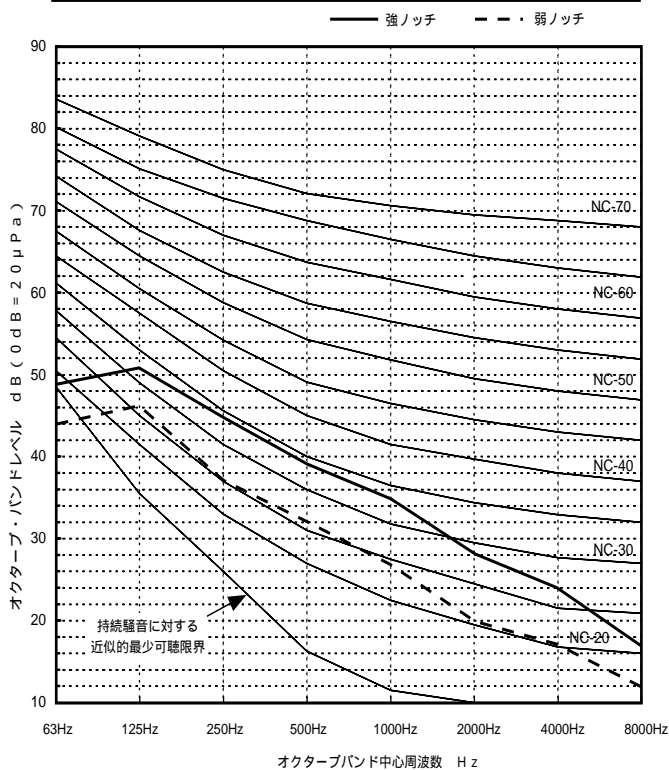

### PEFY-P112・P140 M-E1形

	63Hz	125Hz	250Hz	500Hz	1000Hz	2000Hz	4000Hz	8000Hz	A特性計算
強ノッチ	52	53	43	40	37	31	25	19	43
弱ノッチ	46	47	36	33	29	23	17	15	36

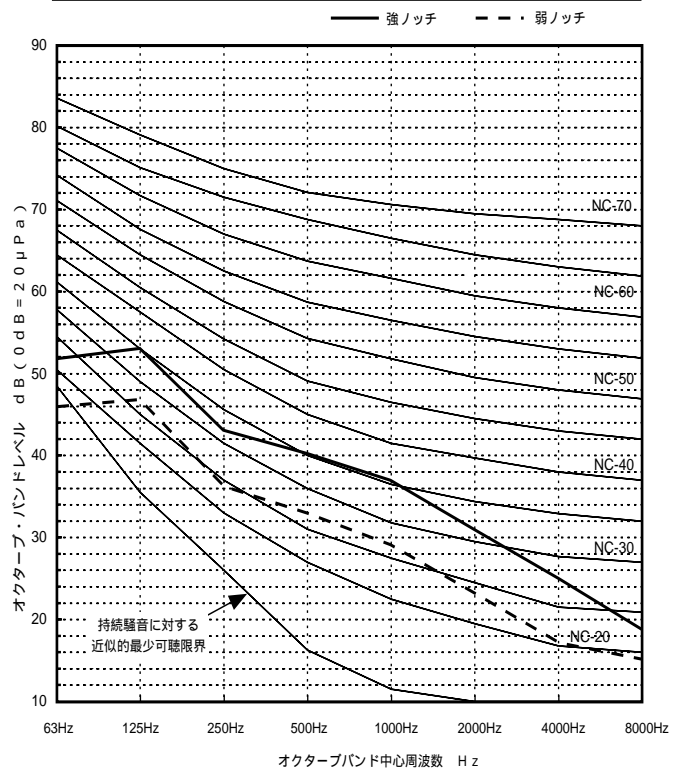

### PEFY-P160M-E1形

	63Hz	125Hz	250Hz	500Hz	1000Hz	2000Hz	4000Hz	8000Hz	A特性計算
強ノッチ	52	53	43	40	37	31	25	19	43
弱ノッチ	46	47	36	33	29	23	17	15	36

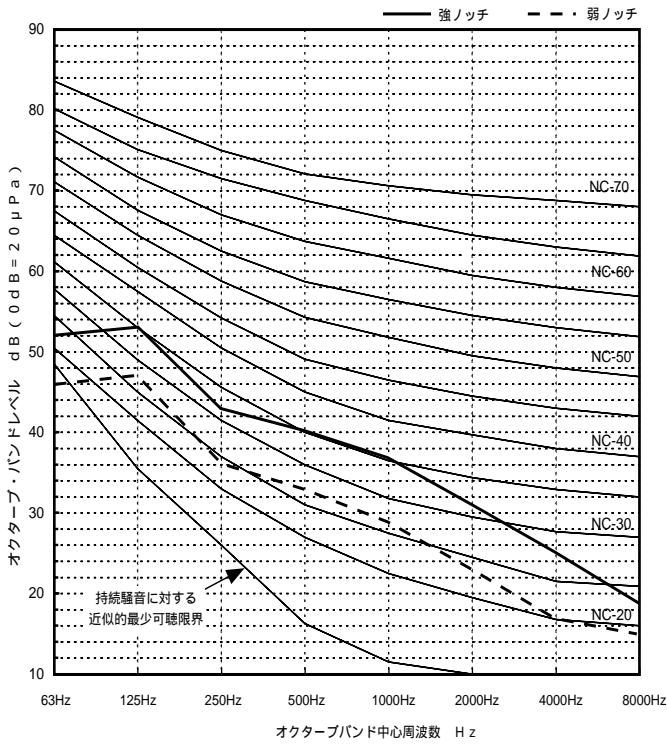

### PEFY-P224M-E1形

	63Hz	125Hz	250Hz	500Hz	1000Hz	2000Hz	4000Hz	8000Hz	A特性計算
強ノッチ 200Pa時	58	53	48	45	40.5	37	32	27	47

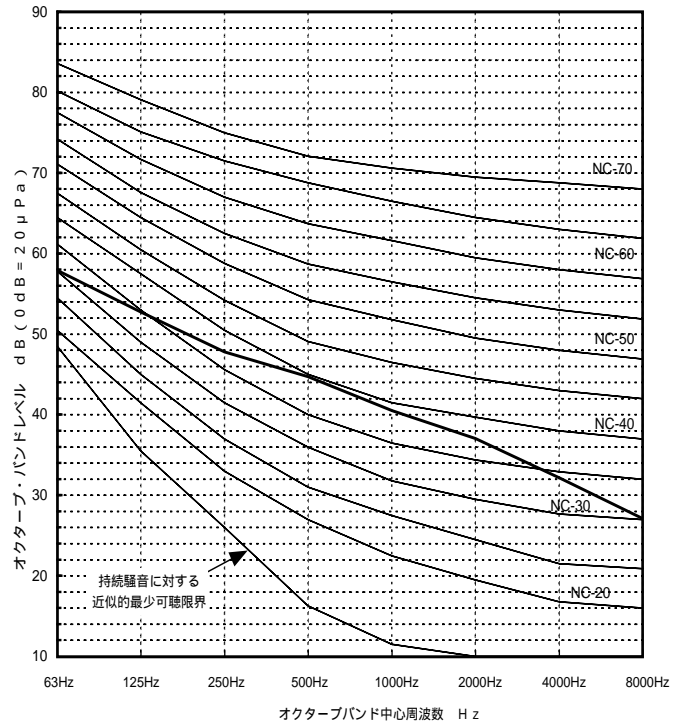

### PEFY-P280M-E1形

	63Hz	125Hz	250Hz	500Hz	1000Hz	2000Hz	4000Hz	8000Hz	A特性計算
強ノッチ 200Pa時	59	57	48	47.5	45	40	35	28	50

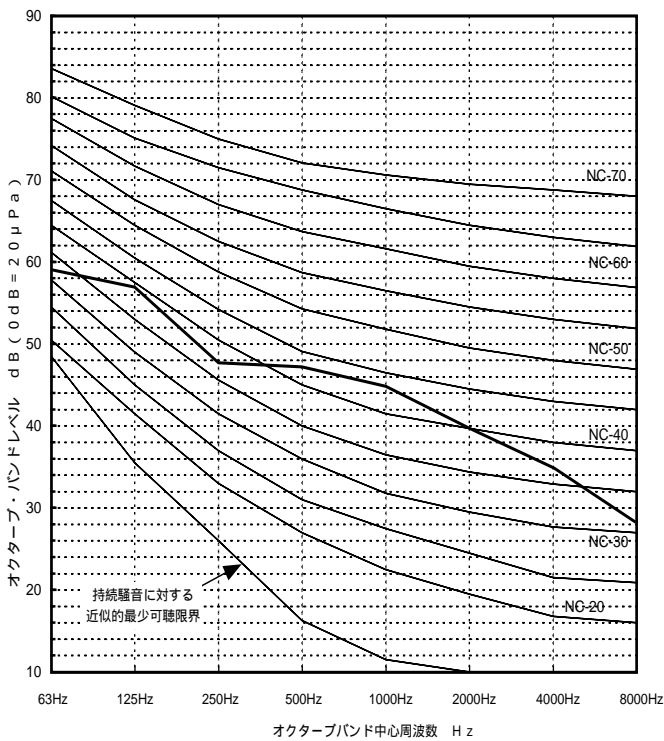

### PCFY-P45GM-E1形

	63Hz	125Hz	250Hz	500Hz	1000Hz	2000Hz	4000Hz	8000Hz	A特性計算
強ノッチ	29	35.5	36.5	35.5	34	29.5	23.5	16	38
中1ノッチ	28	33.5	35	33.5	32	27	21.5	13.5	36
中2ノッチ	26.5	31	34	32	28	20	17	11	33
弱ノッチ	26	28	29	28	24.5	17	12.5	10	29

—— 強ノッチ    - - - - 中1ノッチ    - · - · 中2ノッチ    - - - - 弱ノッチ

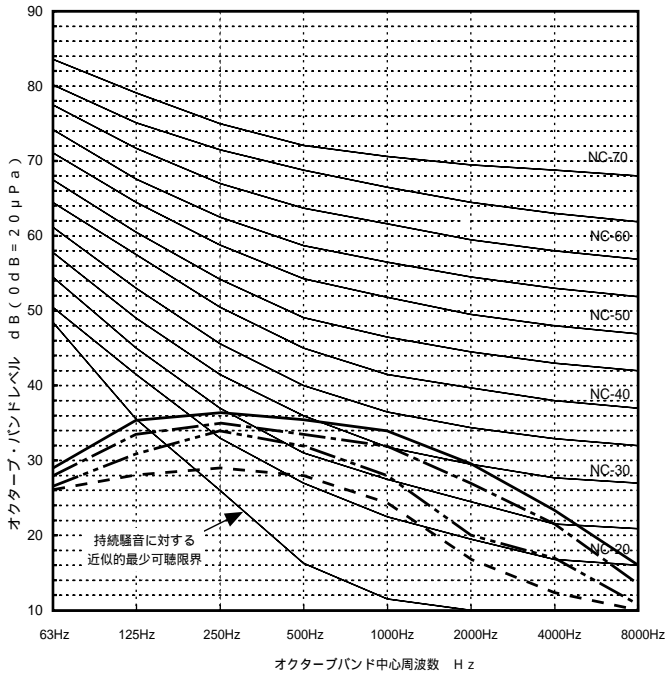

### PCFY-P56GM-E1形

	63Hz	125Hz	250Hz	500Hz	1000Hz	2000Hz	4000Hz	8000Hz	A特性計算
強ノッチ	30	36.5	37.5	36.5	35	30.5	24.5	16	39
中1ノッチ	28	34.5	36	34.5	33	28	22.5	14	37
中2ノッチ	27	32	35	33	29	21	17.5	11	34
弱ノッチ	26	28	29	28	24.5	17	12.5	10	29

—— 強ノッチ    - - - - 中1ノッチ    - · - · 中2ノッチ    - - - - 弱ノッチ

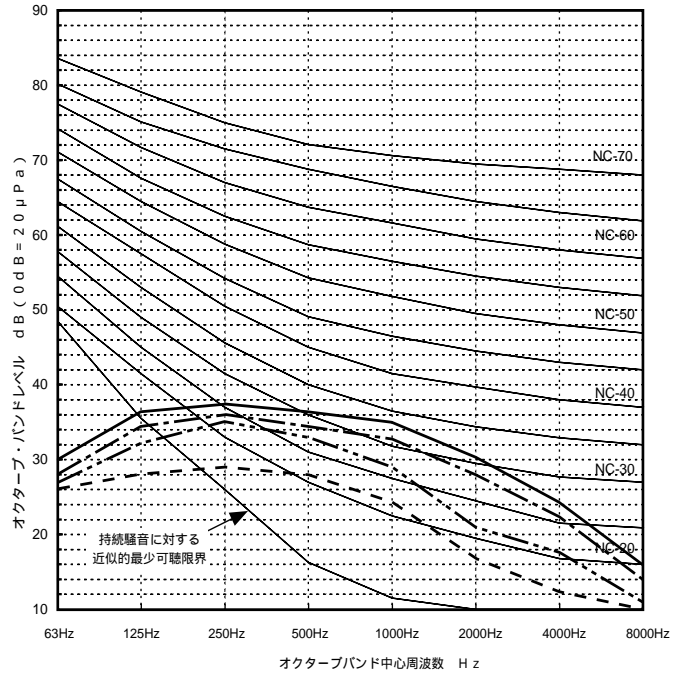

### PCFY-P71・80GM-E1形

	63Hz	125Hz	250Hz	500Hz	1000Hz	2000Hz	4000Hz	8000Hz	A特性計算
強ノッチ	33	37.5	38	36	35	31	23	15	39
中1ノッチ	31	35.5	36	34	33	29	21	13	37
中2ノッチ	26.5	35	33	32	30	24	16	12	34
弱ノッチ	25.5	34	31.5	30	28	22	14	10	32

—— 強ノッチ    - - - - 中1ノッチ    - · - · 中2ノッチ    - - - - 弱ノッチ

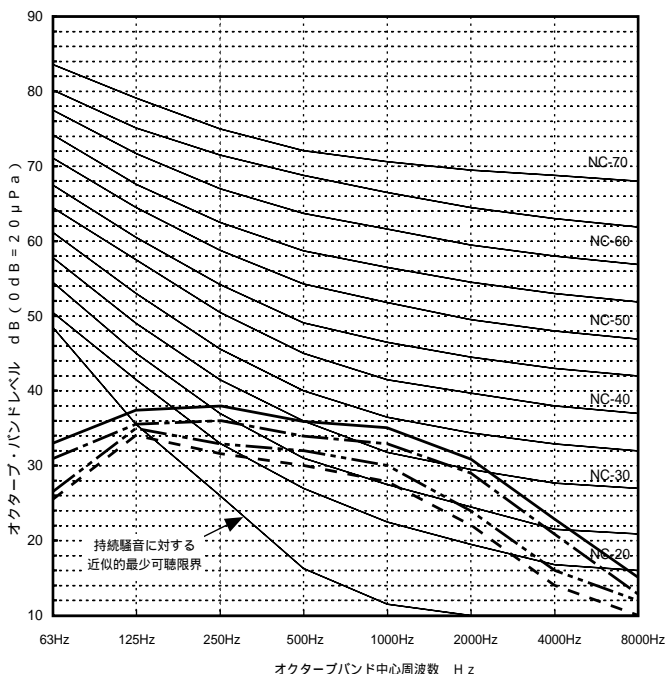

### PCFY-P90・112GM-E1形

	63Hz	125Hz	250Hz	500Hz	1000Hz	2000Hz	4000Hz	8000Hz	A特性計算
強ノッチ	35	41	41	38.5	40	35	29	19	43
中1ノッチ	33	40.5	37.5	36.5	37	34.5	28	18.5	41
中2ノッチ	31.5	39.5	36.5	34.5	34.5	29	21	16	38
弱ノッチ	30	38.5	35	33	32.5	27.5	20	12.5	36

—— 強ノッチ    - - - - 中1ノッチ    - · - · 中2ノッチ    - - - - 弱ノッチ

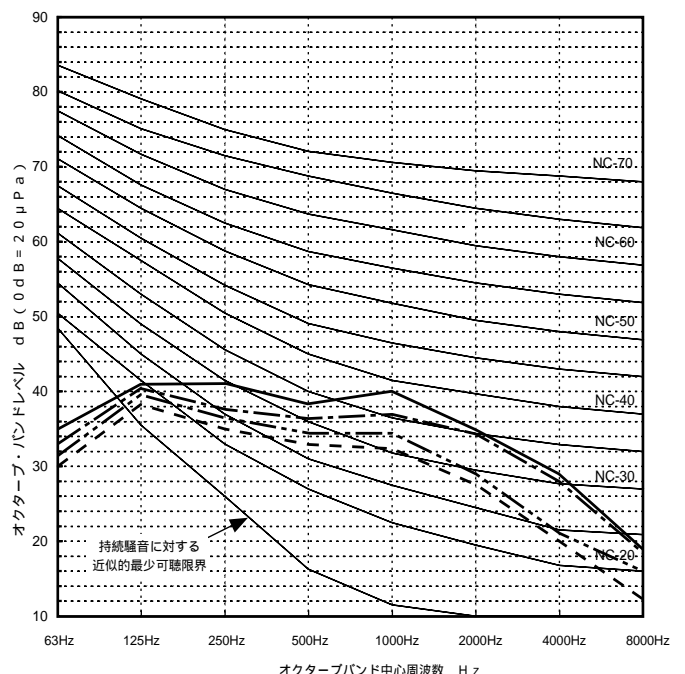



### PCFY-P140GM-E1形

	63Hz	125Hz	250Hz	500Hz	1000Hz	2000Hz	4000Hz	8000Hz	A特性計算
強ノッチ	37	41	40	40	40.5	37	32.5	22.5	44
中1ノッチ	35	39	38.5	38	38	35	30.5	20.5	42
中2ノッチ	32	36	37.5	35.5	35	32	25	17	39
弱ノッチ	30	34	35.5	33.5	33	30	23	16	37

—— 強ノッチ    - - - - 中1ノッチ    - · - · 中2ノッチ    - - - - 弱ノッチ

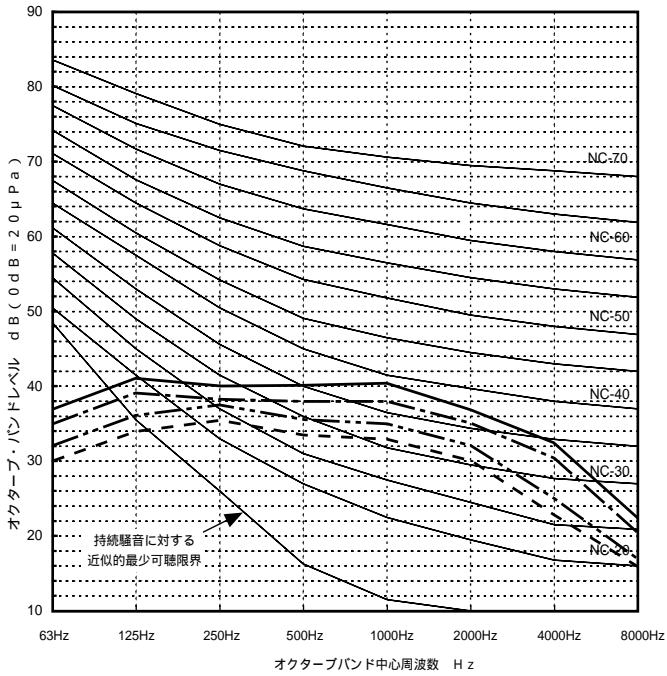

### PCFY-P160GM-E1形

	63Hz	125Hz	250Hz	500Hz	1000Hz	2000Hz	4000Hz	8000Hz	A特性計算
強ノッチ	39	43	42	42	42.5	39	34.5	24.5	46
中1ノッチ	37	41	40	40	40.5	37	32.5	22.5	44
中2ノッチ	34	38.5	39.5	37.5	37	34.5	27	19	41
弱ノッチ	32	36	37.5	35.5	35	32	25	17	39

—— 強ノッチ    - - - - 中1ノッチ    - · - · 中2ノッチ    - - - - 弱ノッチ

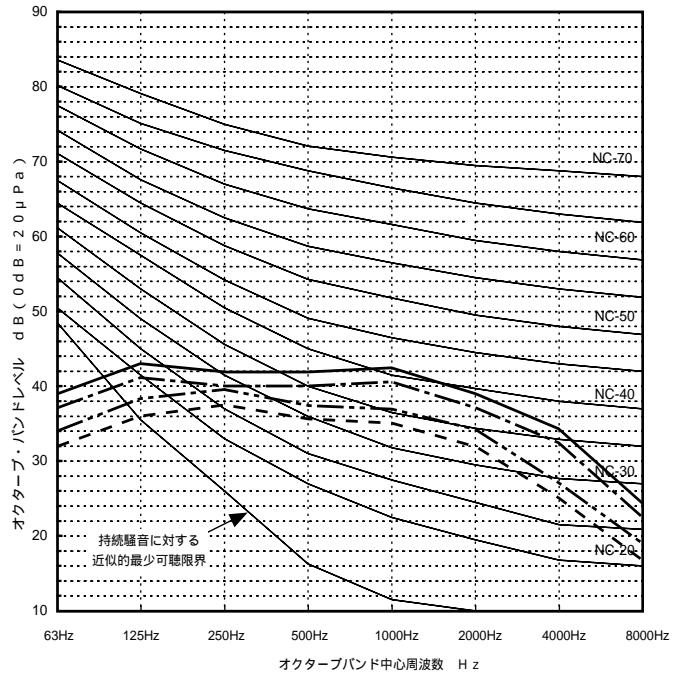

### PKFY-P22・28AM(S)-E1形

	63Hz	125Hz	250Hz	500Hz	1000Hz	2000Hz	4000Hz	8000Hz	A特性計算
強ノッチ	40	28	27	32	34	25	19	15	36
弱ノッチ	36	24	23	28	30	21	15	11	32

—— 強ノッチ    - - - - 弱ノッチ

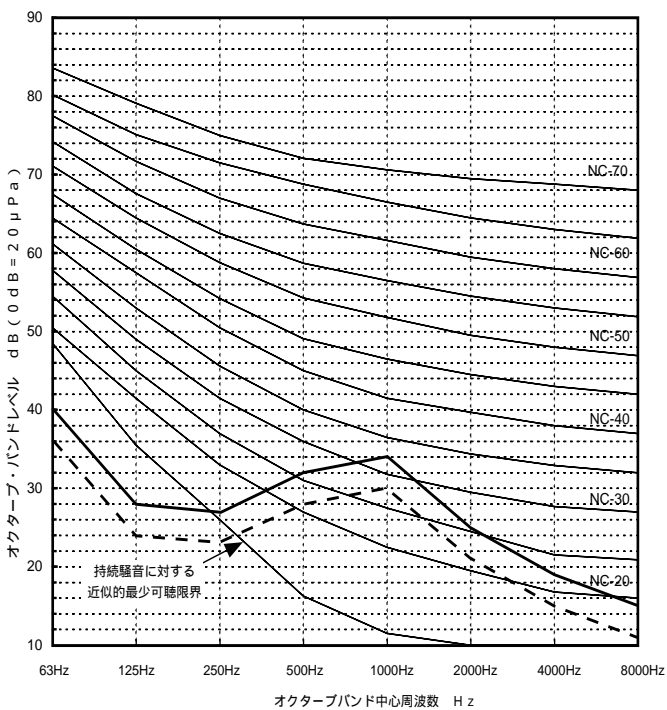

### PKFY-P36・45GM-E1形

	63Hz	125Hz	250Hz	500Hz	1000Hz	2000Hz	4000Hz	8000Hz	A特性計算
強ノッチ	29.7	31.6	35.5	36.3	37.3	31.6	23.5	11.3	40.0
中1ノッチ	28.1	29.6	33.9	34.7	35.3	29.4	20.6	8.9	38.0
中2ノッチ	26.3	27.8	30.9	32.8	31.8	25.7	16.2	7.0	35.0
弱ノッチ	23.7	24.8	28.0	28.5	28.3	21.4	11.9	5.4	31.0

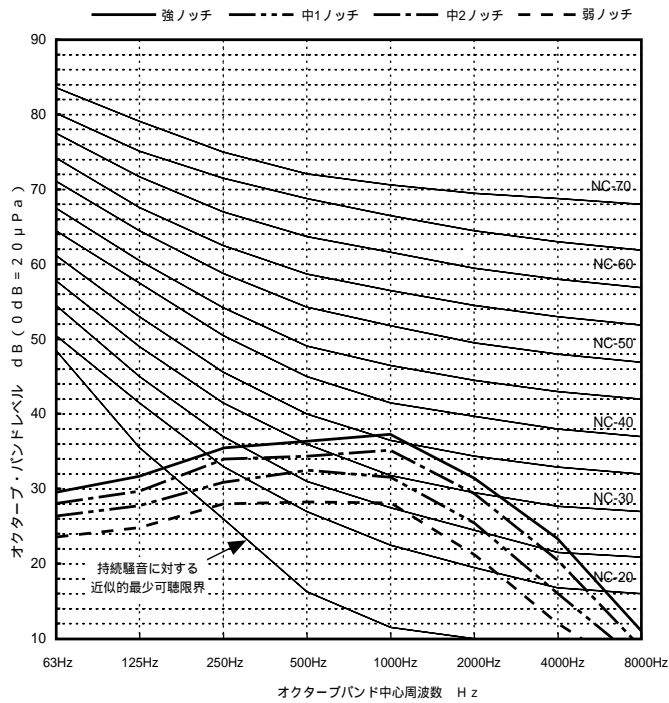

### PKFY-P56GM-E1形

	63Hz	125Hz	250Hz	500Hz	1000Hz	2000Hz	4000Hz	8000Hz	A特性計算
強ノッチ	30.7	32.6	36.5	37.3	38.3	32.6	24.5	12.3	41.0
中1ノッチ	29.1	30.6	34.9	35.7	36.3	30.4	21.6	9.9	39.0
中2ノッチ	27.3	28.8	31.9	33.8	32.8	26.7	17.2	8.0	36.0
弱ノッチ	25.7	26.8	30.0	30.5	30.3	23.4	13.9	7.4	33.0

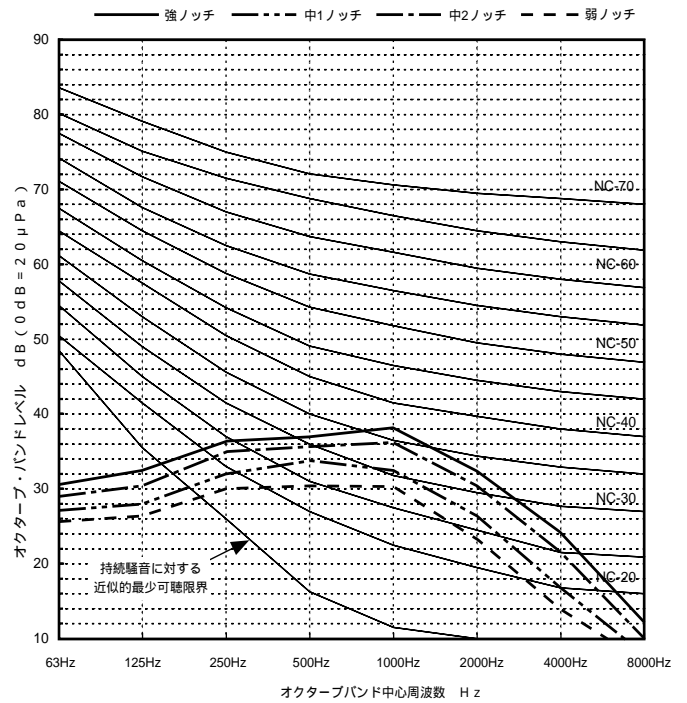

### PFFY-P28LEM-E1形 PFFY-P28LRM-E1形

	63Hz	125Hz	250Hz	500Hz	1000Hz	2000Hz	4000Hz	8000Hz	A特性計算
強ノッチ	35	34	33	36.5	32	27	17	14	37
弱ノッチ	32	29	28	31	26	18	14	8	31

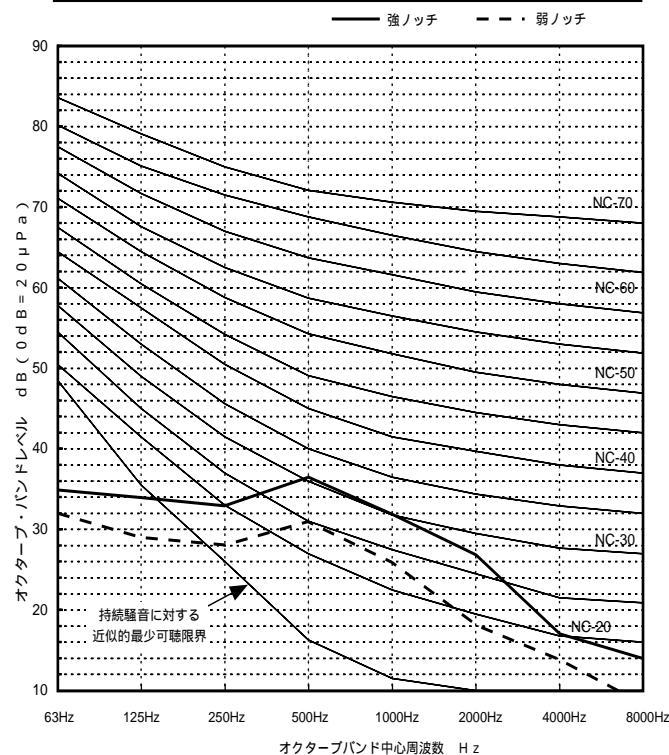

### PFFY-P36LEM-E1形 PFFY-P36LRM-E1形

	63Hz	125Hz	250Hz	500Hz	1000Hz	2000Hz	4000Hz	8000Hz	A特性計算
強ノッチ	37	40	36.5	37	30	25	16	14	37
弱ノッチ	33	32	29	31	24	19	12.5	6	31

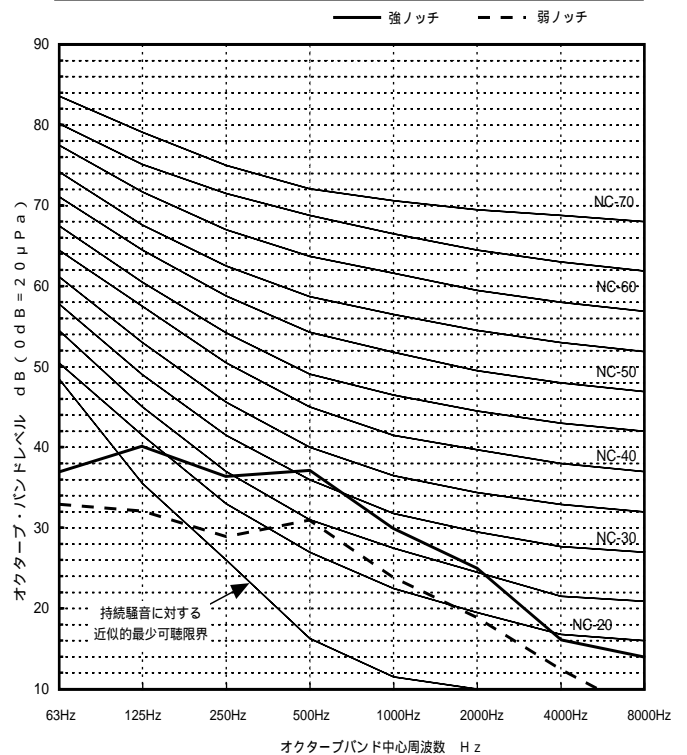

PFFY-P45LEM-E1形  
PFFY-P45LRM-E1形

	63Hz	125Hz	250Hz	500Hz	1000Hz	2000Hz	4000Hz	8000Hz	A特性計算
強ノッチ	38	41	39	40	34	27	19	15	40
弱ノッチ	34	35	34	33	28	23.5	17	10	34

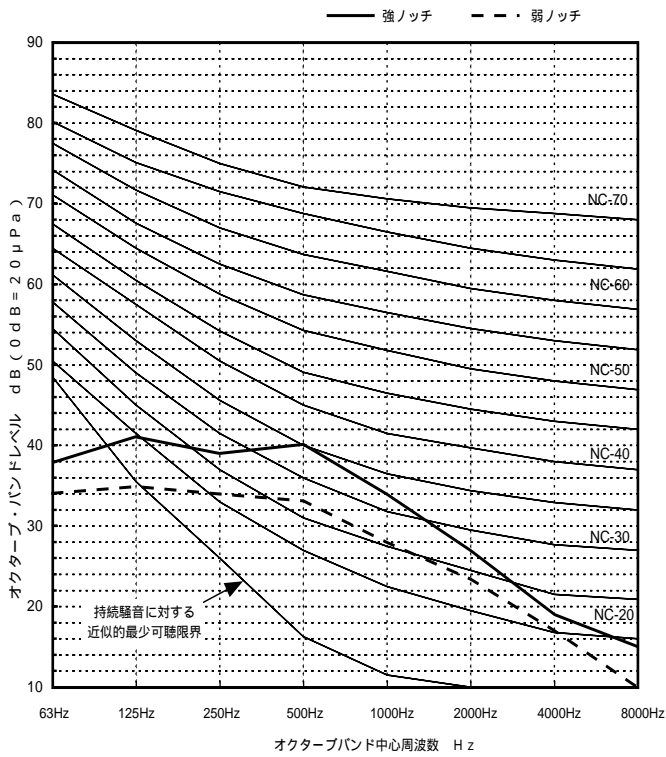

PFFY-P56LEM-E1形  
PFFY-P56LRM-E1形

	63Hz	125Hz	250Hz	500Hz	1000Hz	2000Hz	4000Hz	8000Hz	A特性計算
強ノッチ	39	40	41	42	36	29	22	18	42
弱ノッチ	37	37	36	38	29	24	18	14	37

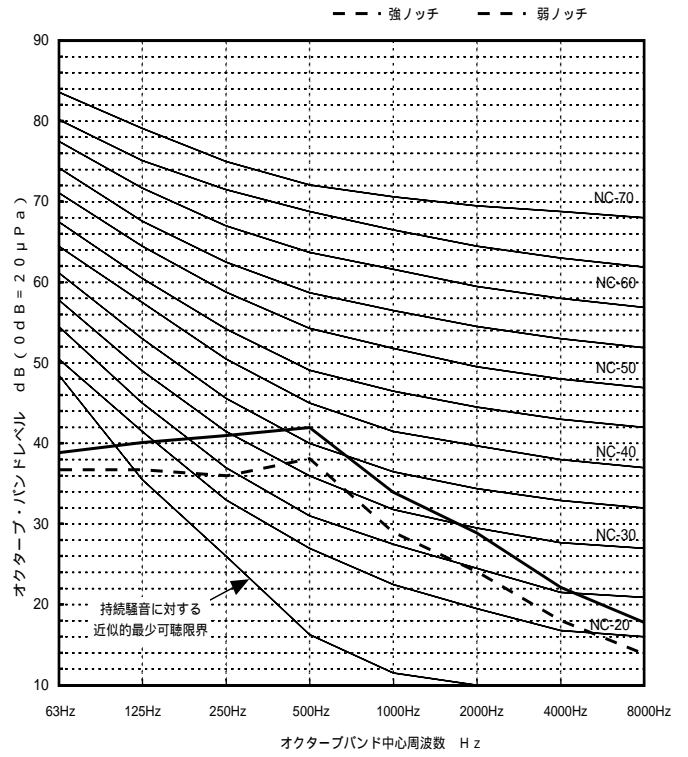

PFFY-P71LEM-E1形  
PFFY-P71LRM-E1形

	63Hz	125Hz	250Hz	500Hz	1000Hz	2000Hz	4000Hz	8000Hz	A特性計算
強ノッチ	42	43.5	44	44.5	37	31	25	20	44
弱ノッチ	37	37	36	38	31	27	20	17	38

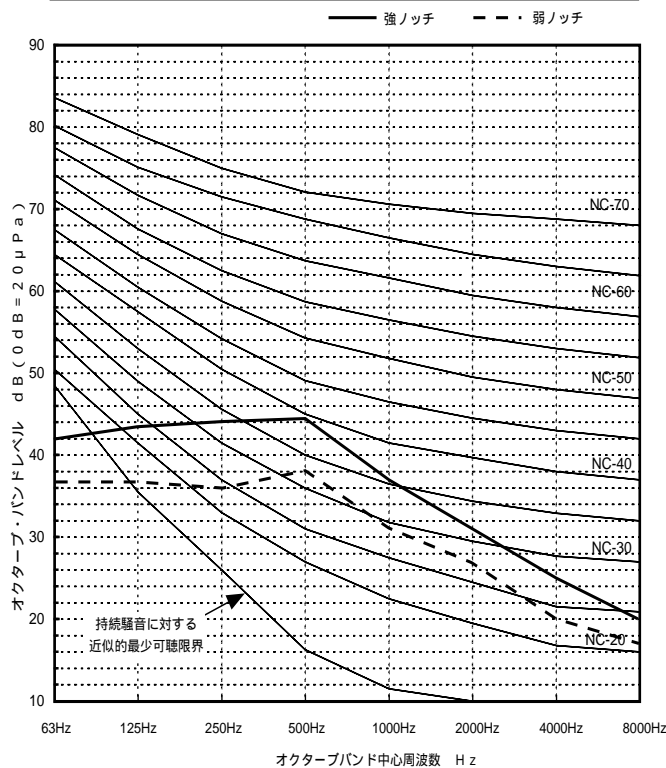

### PFFY-P224DM-E1形

	63Hz	125Hz	250Hz	500Hz	1000Hz	2000Hz	4000Hz	8000Hz	A特性計算
50Hz	61.0	60.5	55.5	50.5	47.0	39.0	33.0	25.5	53
60Hz	63.5	61.0	55.0	49.5	47.5	41.0	34.0	26.5	53

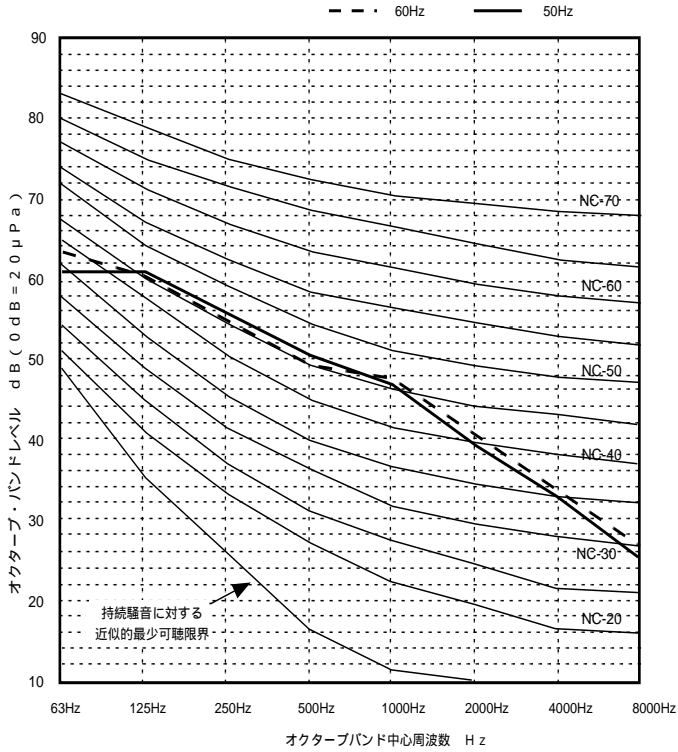

### PFFY-P280DM-E1形

	63Hz	125Hz	250Hz	500Hz	1000Hz	2000Hz	4000Hz	8000Hz	A特性計算
50Hz	68.0	63.0	59.0	50.0	46.5	45.5	36.0	32.0	55
60Hz	66.0	63.0	58.5	51.0	47.5	44.0	38.5	32.0	55

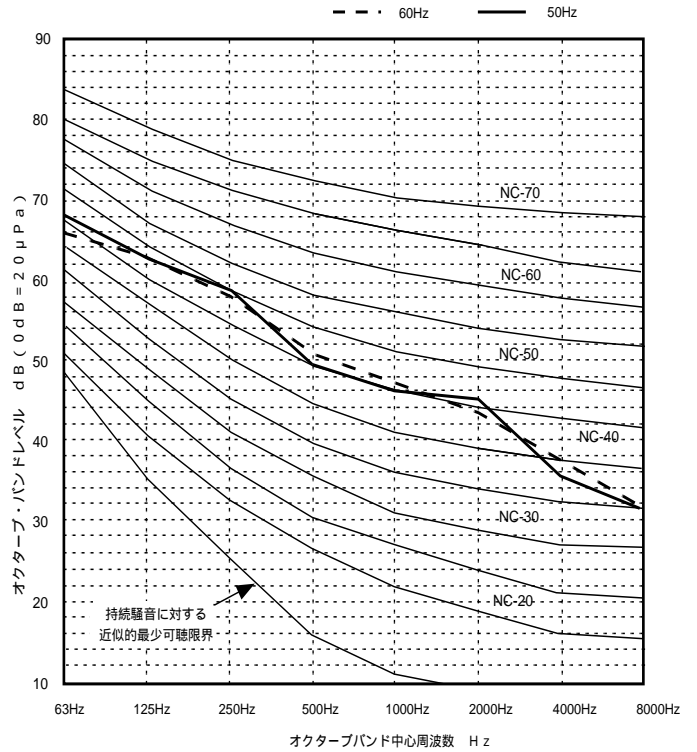

### PFFY-P450DM-E1形

	63Hz	125Hz	250Hz	500Hz	1000Hz	2000Hz	4000Hz	8000Hz	A特性計算
50Hz	63.0	60.5	56.5	50.5	45.0	41.0	35.5	29.5	53
60Hz	63.0	62.0	59.0	52.0	47.5	43.0	37.5	29.5	55

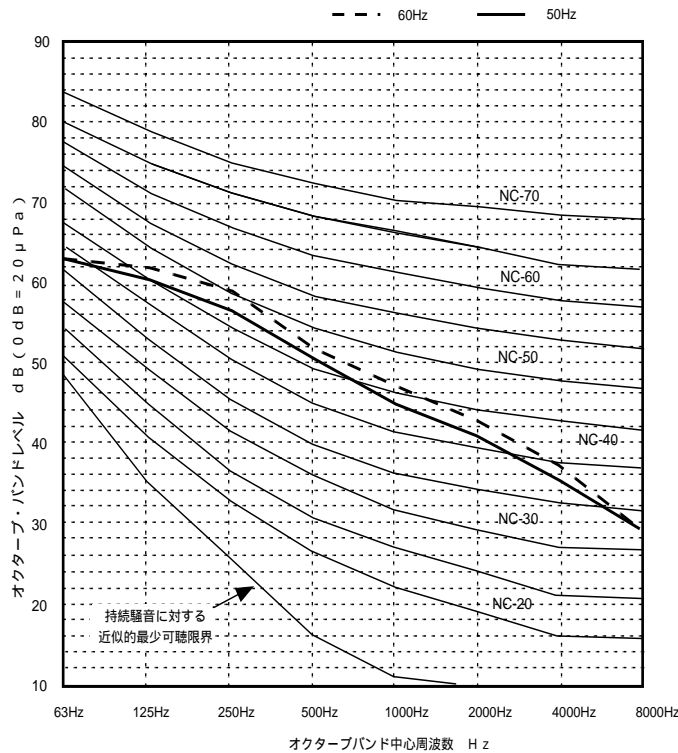

### PFFY-P560DM-E1形

	63Hz	125Hz	250Hz	500Hz	1000Hz	2000Hz	4000Hz	8000Hz	A特性計算
50Hz	68.0	65.0	59.0	53.0	52.0	44.0	35.0	27.0	57
60Hz	70.5	67.0	63.0	56.5	54.0	49.0	40.0	33.0	60

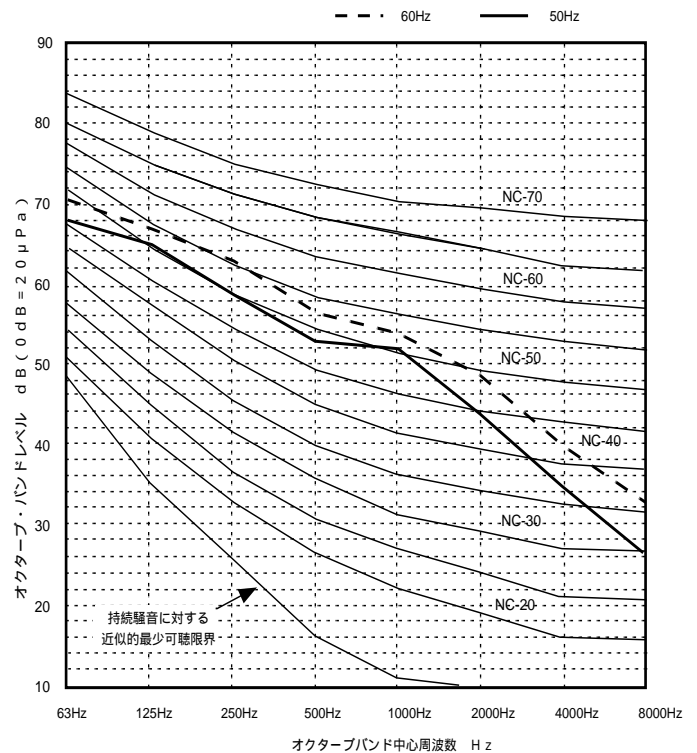

### PSFY-P56GM-E1形

	63Hz	125Hz	250Hz	500Hz	1000Hz	2000Hz	4000Hz	8000Hz	A特性計算
強ノッチ	34.8	41.7	39.0	36.6	31.8	28.3	22.6	15.0	38.0
弱ノッチ	31.3	38.1	34.3	31.5	26.9	22.4	16.5	11.7	33.0

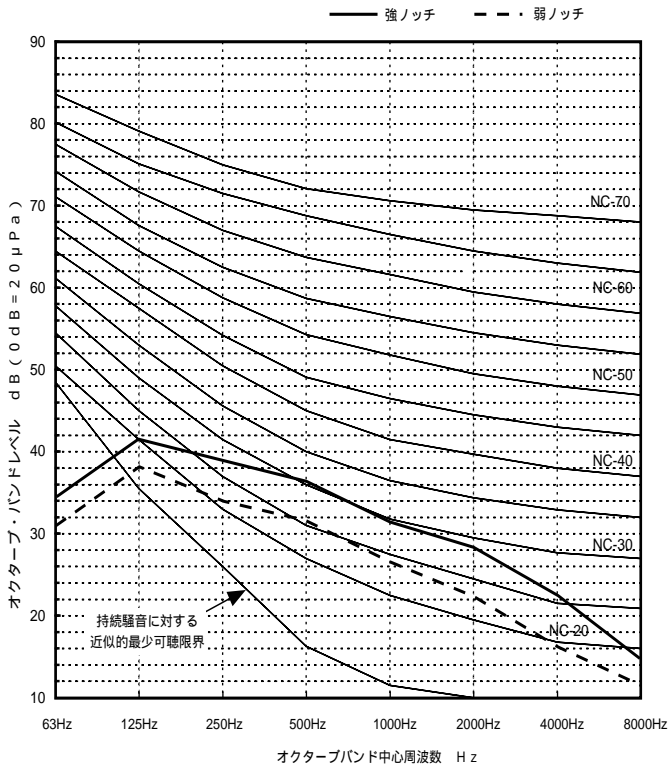

### PSFY-P71GM-E1形

	63Hz	125Hz	250Hz	500Hz	1000Hz	2000Hz	4000Hz	8000Hz	A特性計算
強ノッチ	36.3	44.2	41.0	36.8	34.9	31.2	25.7	17.7	40.0
弱ノッチ	32.4	40.4	35.8	32.4	29.7	25.6	19.0	11.2	35.0

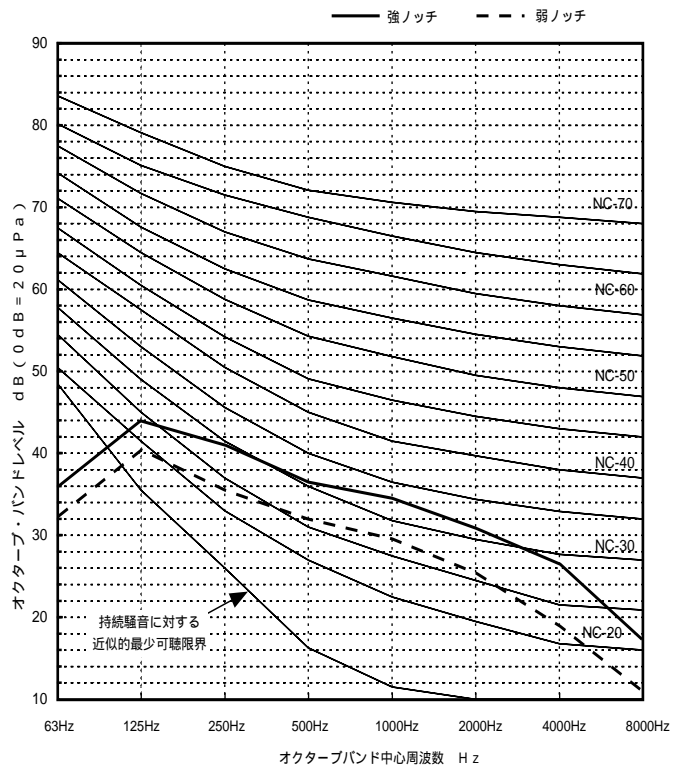

### PSFY-P80GM-E1形

	63Hz	125Hz	250Hz	500Hz	1000Hz	2000Hz	4000Hz	8000Hz	A特性計算
強ノッチ	38.3	46.2	43.0	38.8	36.9	33.2	27.7	19.7	42.0
弱ノッチ	34.4	42.4	37.8	34.4	31.7	27.6	21.0	13.2	37.0

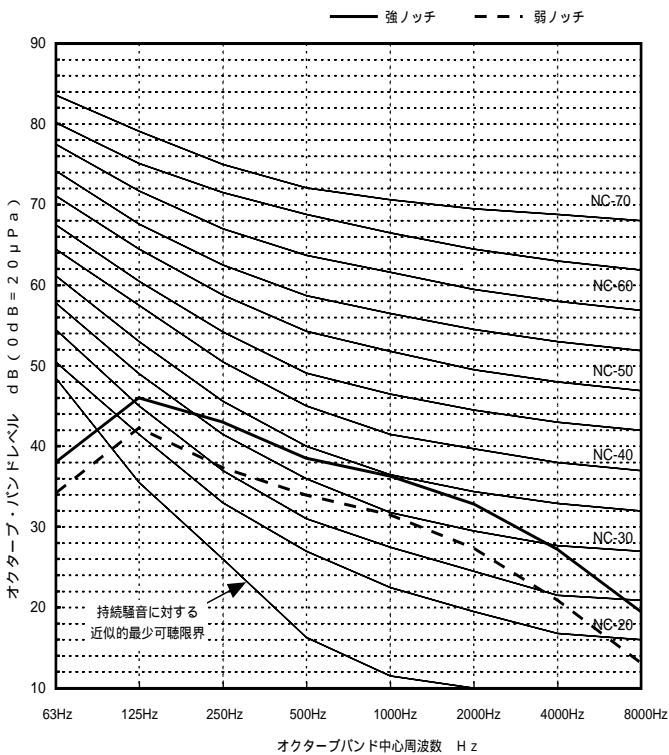

### PSFY-P112GM-E1形

	63Hz	125Hz	250Hz	500Hz	1000Hz	2000Hz	4000Hz	8000Hz	A特性計算
強ノッチ	45.6	53.0	50.1	44.4	42.1	39.1	34.3	26.0	48.0
弱ノッチ	41.3	48.4	44.8	38.1	35.8	32.6	26.6	19.3	42.0

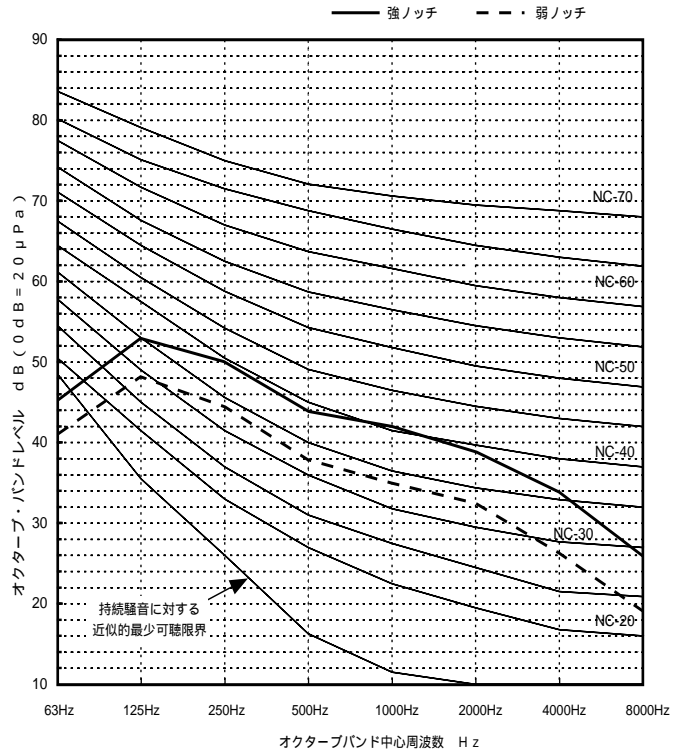

### PSFY-P140GM-E1形

	63Hz	125Hz	250Hz	500Hz	1000Hz	2000Hz	4000Hz	8000Hz	A特性計算
強ノッチ	46.7	53.9	49.7	45.7	43.0	41.3	35.8	27.6	49.0
弱ノッチ	42.0	49.2	44.0	39.5	37.5	34.4	28.5	20.3	43.0

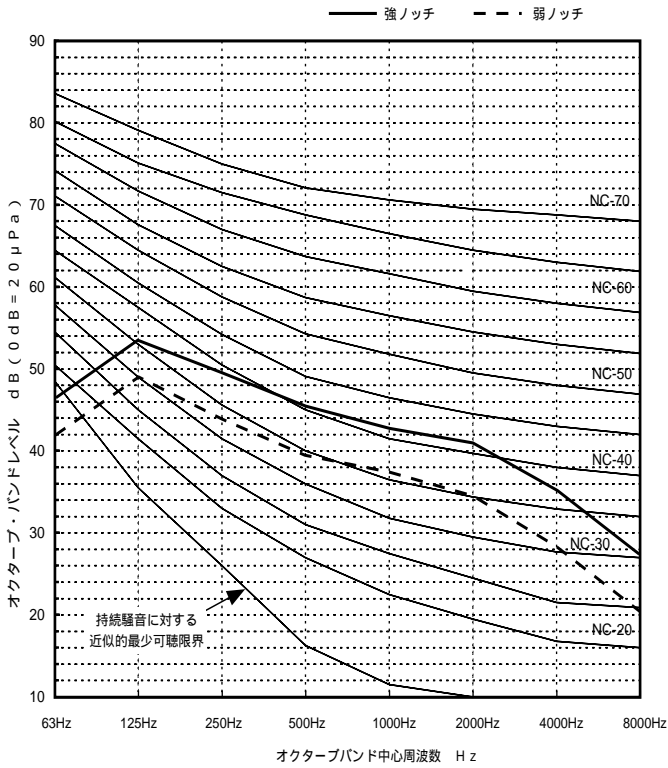

### PSFY-P160GM-E1形

	63Hz	125Hz	250Hz	500Hz	1000Hz	2000Hz	4000Hz	8000Hz	A特性計算
強ノッチ	49.7	56.9	52.7	48.7	46.0	44.3	38.8	30.6	52.0
弱ノッチ	45.0	52.2	47.0	42.5	40.5	37.4	31.5	23.3	46.0

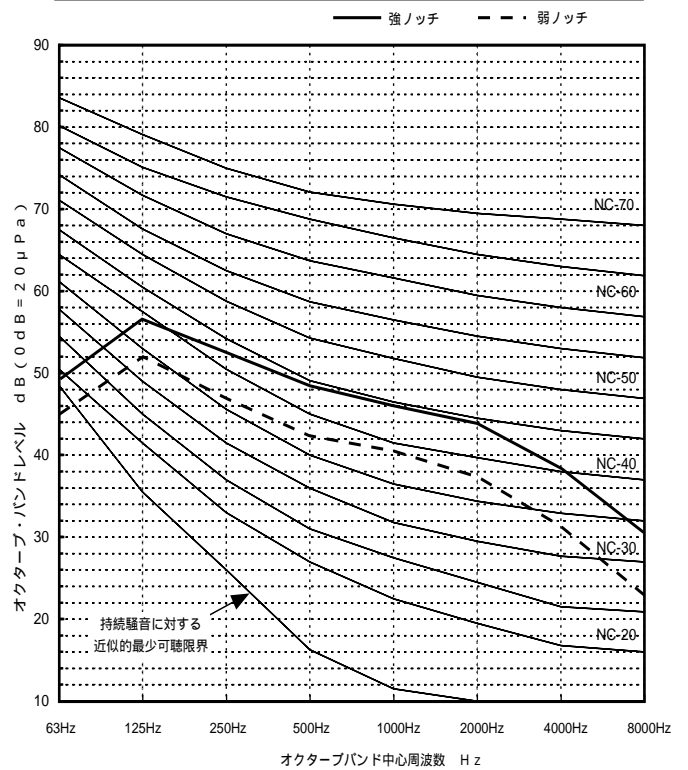

### PCFY-P80HM-E1形

	63Hz	125Hz	250Hz	500Hz	1000Hz	2000Hz	4000Hz	8000Hz	A特性計算
強ノッチ	32.5	34.5	36.5	33.5	35	30	21.5	13.5	38
弱ノッチ	31	30	29	28	29.5	22.5	13	11.5	32

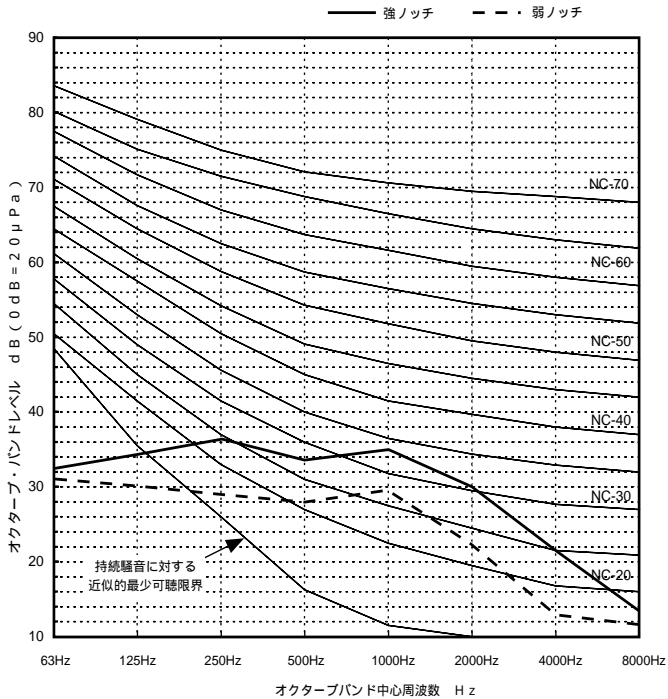

### PCFY-P140HM-E1形

	63Hz	125Hz	250Hz	500Hz	1000Hz	2000Hz	4000Hz	8000Hz	A特性計算
強ノッチ	37.5	40	44.5	44	47.5	42.5	34.5	28	50
弱ノッチ	33.5	37	38	39	41.5	36.5	25.5	19.5	44

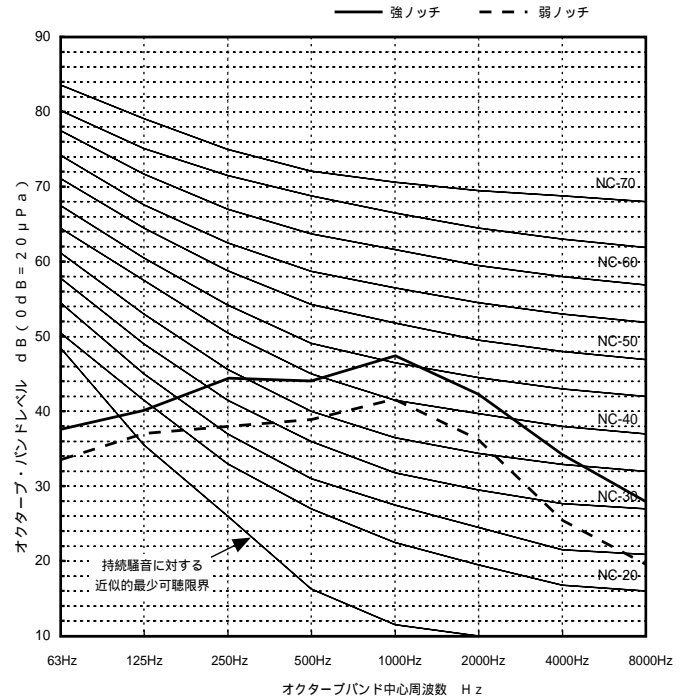

### PFFY-P112RM-E1形

	63Hz	125Hz	250Hz	500Hz	1000Hz	2000Hz	4000Hz	8000Hz	A特性計算
50Hz	54.0	55.0	50.0	45.0	41.0	32.0	27.0	24.0	47
60Hz	56.0	56.0	51.0	46.0	42.0	33.0	28.0	25.0	48

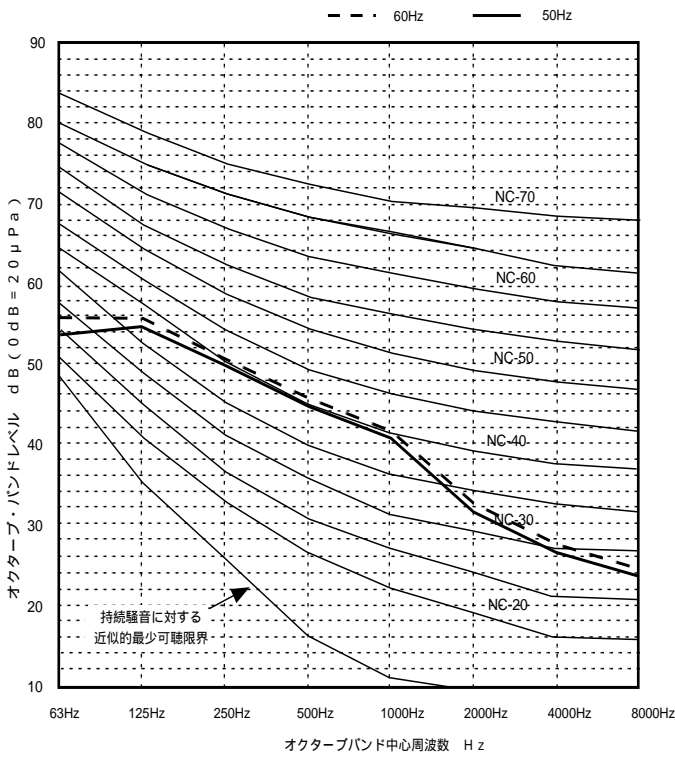

### PFFY-P140RM-E1形

	63Hz	125Hz	250Hz	500Hz	1000Hz	2000Hz	4000Hz	8000Hz	A特性計算
50Hz	57.0	58.0	52.0	47.0	43.0	33.0	27.0	24.0	49
60Hz	59.0	60.0	53.0	48.0	44.0	34.0	29.0	26.0	50

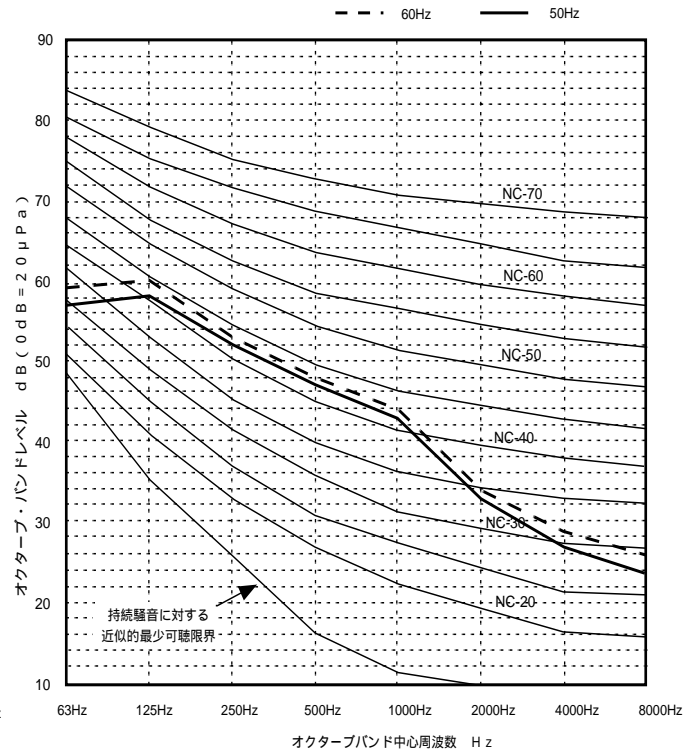

### PFFY-P224RM-E1形

	63Hz	125Hz	250Hz	500Hz	1000Hz	2000Hz	4000Hz	8000Hz	A特性計算
50Hz	63.0	62.0	55.0	50.0	45.0	36.0	30.0	27.0	52.5
60Hz	63.0	62.0	55.0	50.0	45.0	36.0	30.0	27.0	52.5

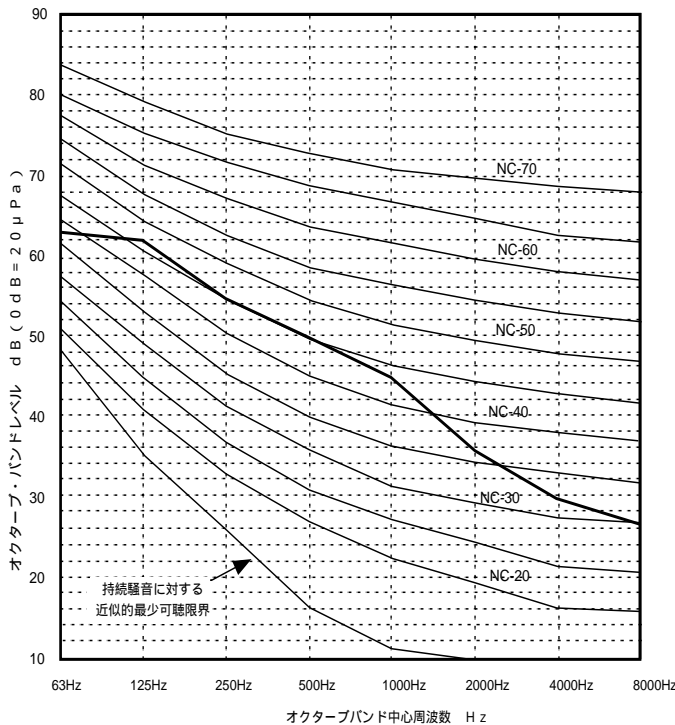

### PFFY-P280RM-E1形

	63Hz	125Hz	250Hz	500Hz	1000Hz	2000Hz	4000Hz	8000Hz	A特性計算
50Hz	64.0	62.0	55.0	51.0	49.0	47.0	43.0	36.0	55.0
60Hz	64.0	62.0	55.0	51.0	49.0	47.0	43.0	36.0	55.0

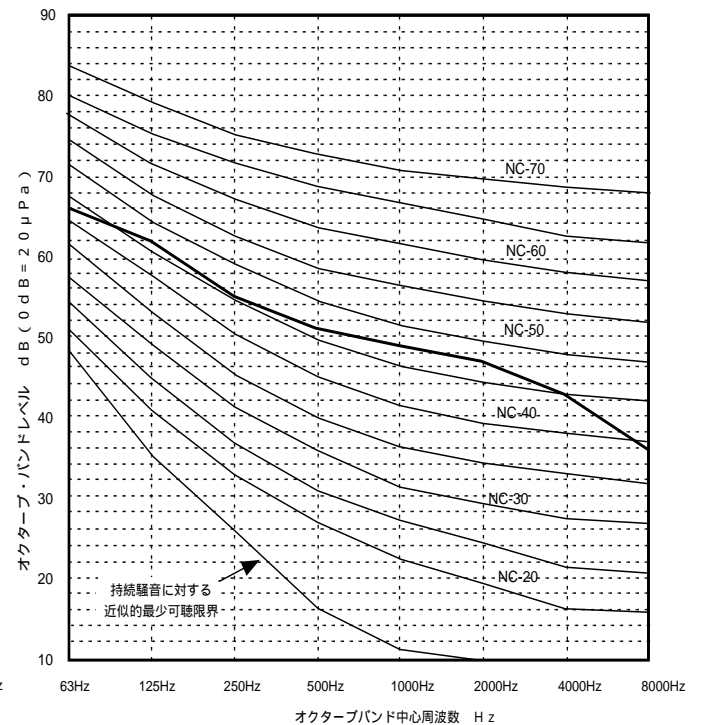

### PEFY-P22・28ML-E(-R)形

	63Hz	125Hz	250Hz	500Hz	1000Hz	2000Hz	4000Hz	8000Hz	A特性計算
強ノッチ	35.0	30.9	32.3	29.1	23.7	16.3	12.5	13.8	30.0
中ノッチ	33.9	26.4	27.5	23.0	17.8	12.2	12.7	14.3	25.0
弱ノッチ	33.2	23.2	24.3	18.3	13.2	10.7	12.4	14.2	22.0

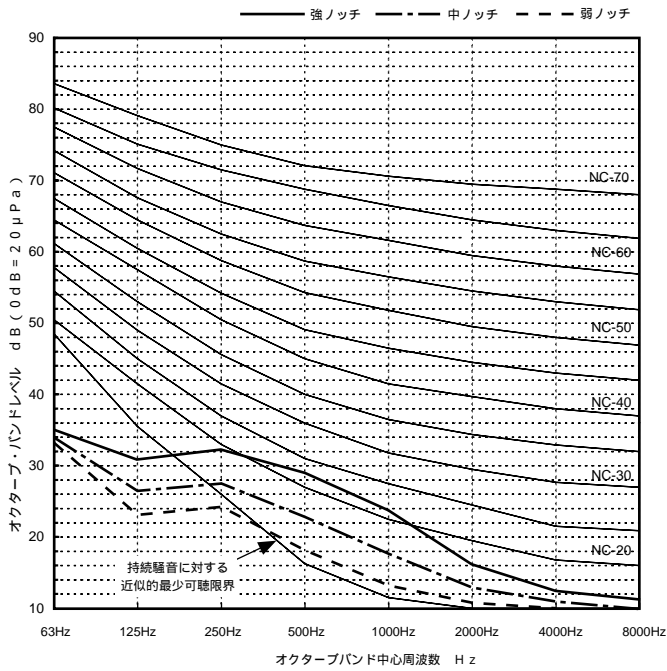

### PEFY-P90M-E1-F形

	63Hz	125Hz	250Hz	500Hz	1000Hz	2000Hz	4000Hz	8000Hz	A特性計算
130Pa時	47	46.5	36.5	31	29	25.5	22.5	19.0	36.0

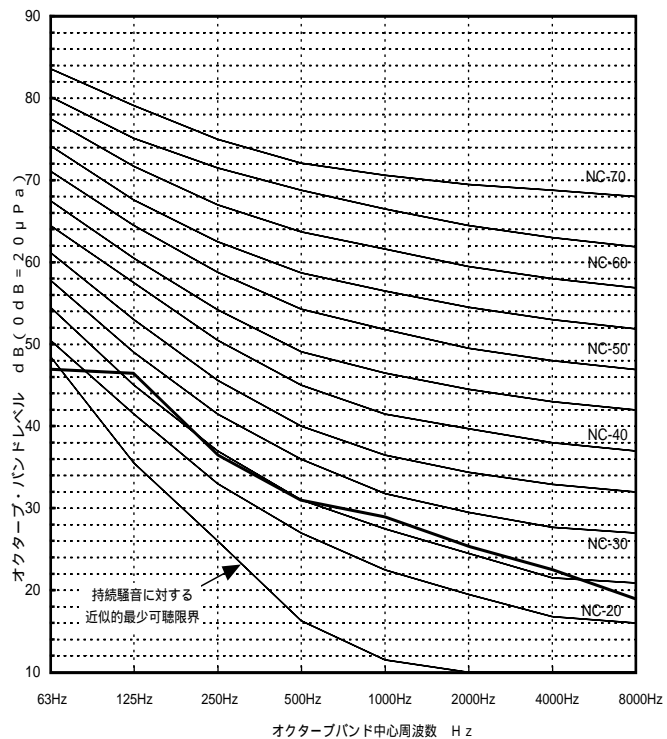

### PEFY-P112・140M-E1-F形

	63Hz	125Hz	250Hz	500Hz	1000Hz	2000Hz	4000Hz	8000Hz	A特性計算
130Pa時	50	46.5	37	31.5	28.5	24	21.5	18.0	36.0

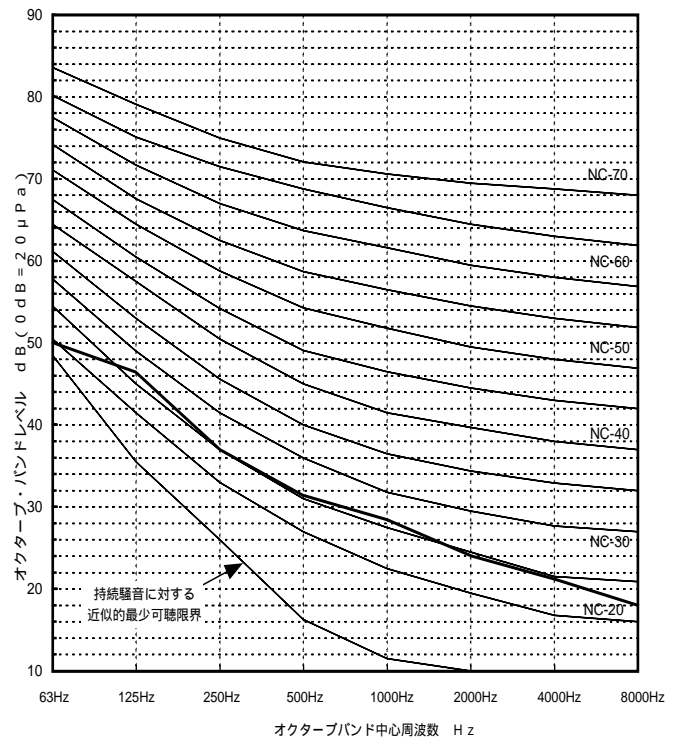



### PEFY-P160M-E1-F形

	63Hz	125Hz	250Hz	500Hz	1000Hz	2000Hz	4000Hz	8000Hz	A特性計算
130Pa時	50.5	46	38.5	35	29	24	21	17	37

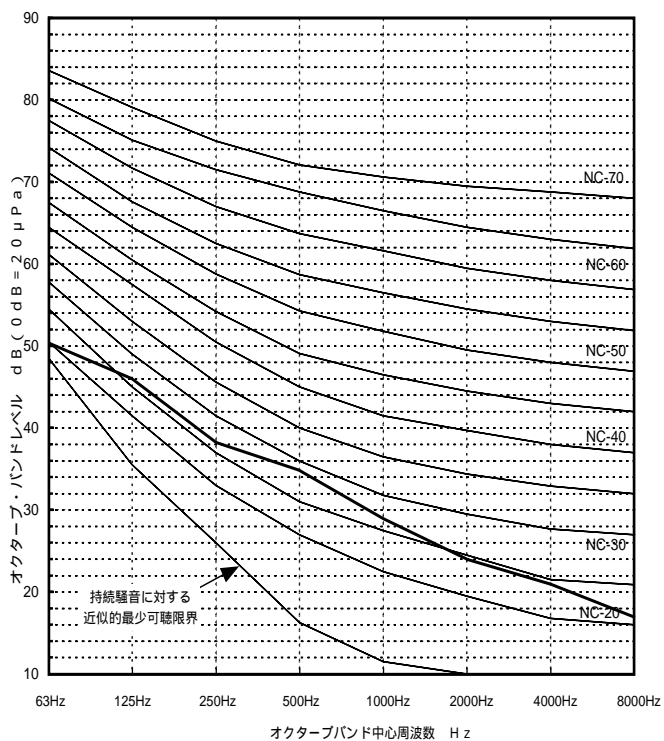

### PEFY-P224M-E1-F形

	63Hz	125Hz	250Hz	500Hz	1000Hz	2000Hz	4000Hz	8000Hz	A特性計算
200Pa時	59.5	53	43	35.5	34	30	26	21	42

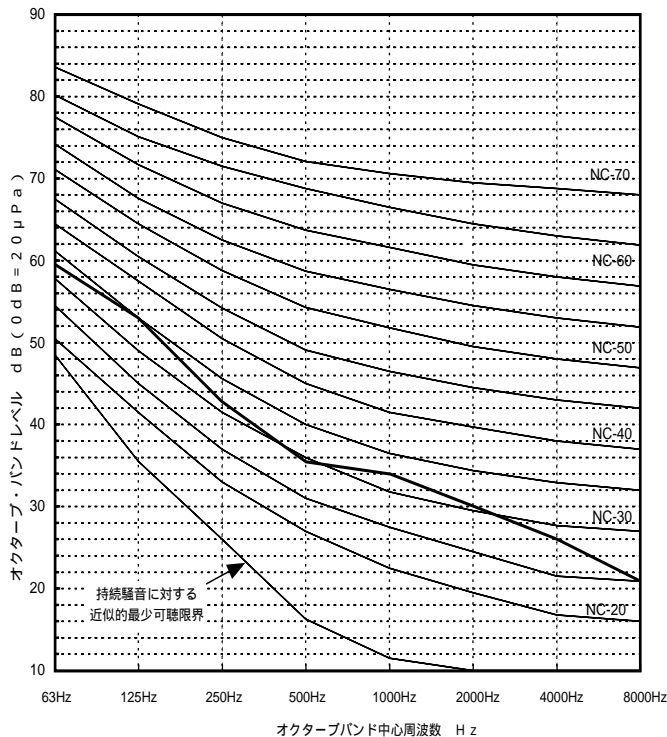

### PEFY-P280M-E1-F形

	63Hz	125Hz	250Hz	500Hz	1000Hz	2000Hz	4000Hz	8000Hz	A特性計算
200Pa時	60.5	55	43	36.5	34	30	26	21	43

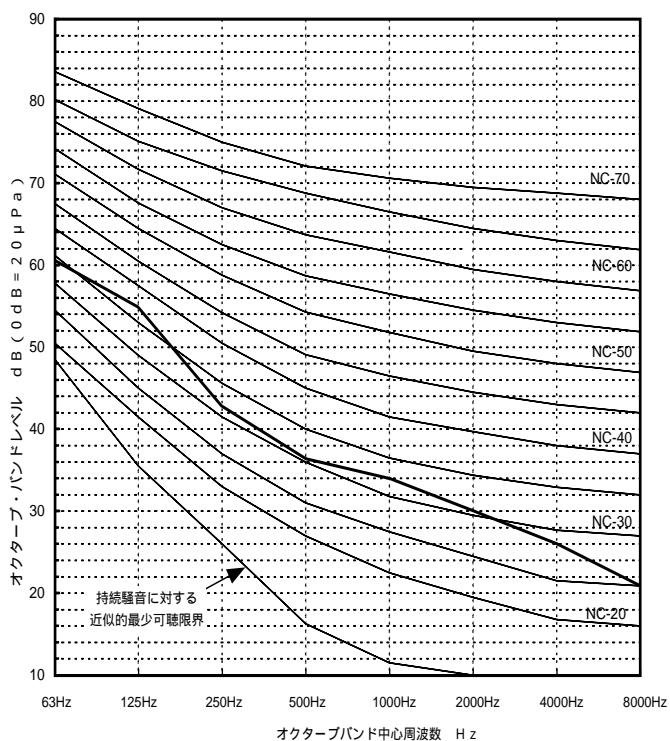

### PFFY-P280RM-E1-F形

	63Hz	125Hz	250Hz	500Hz	1000Hz	2000Hz	4000Hz	8000Hz	A特性計算
200Pa時	61.0	53.5	52.5	45.0	40.0	35.5	30.0	26.0	48

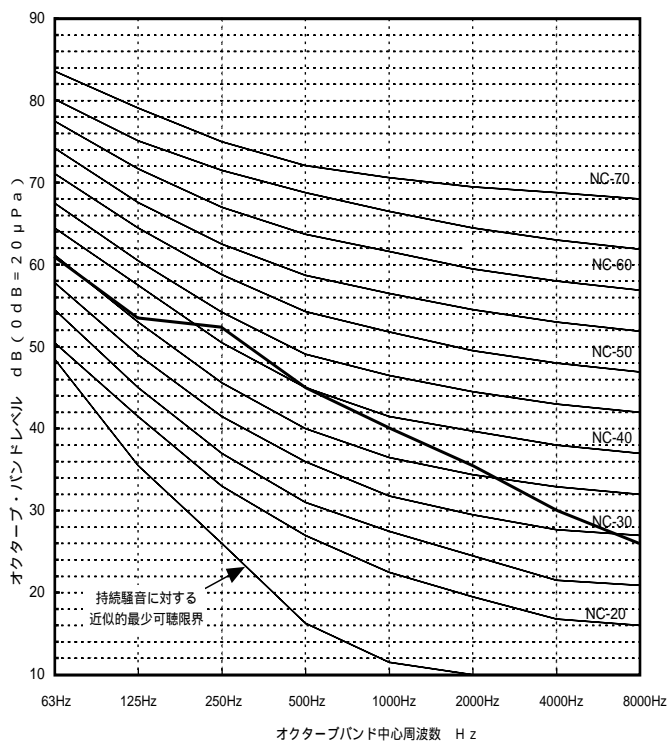

### PLFY-P36CLMD-E1形

	63Hz	125Hz	250Hz	500Hz	1000Hz	2000Hz	4000Hz	8000Hz	A特性計算
強ノッチ	44.5	46.5	38	38.5	31.5	27.5	24	17	39
弱ノッチ	44	45.5	36.5	36	29.5	25.5	20.5	15	37

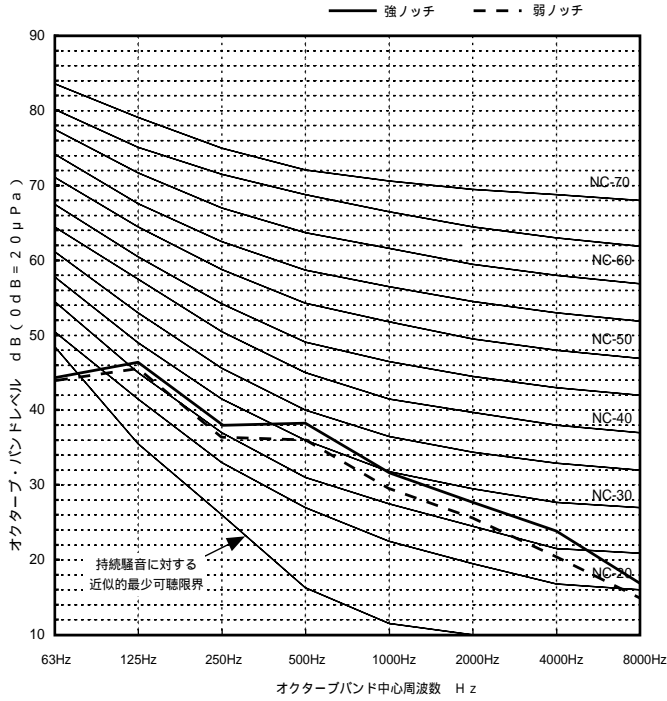

### PLFY-P45・56CLMD-E1形

	63Hz	125Hz	250Hz	500Hz	1000Hz	2000Hz	4000Hz	8000Hz	A特性計算
強ノッチ	46.5	48	41.5	38.5	32	28.5	25	18.5	40
弱ノッチ	46	47	40.5	37	30	26	23	17	38.5

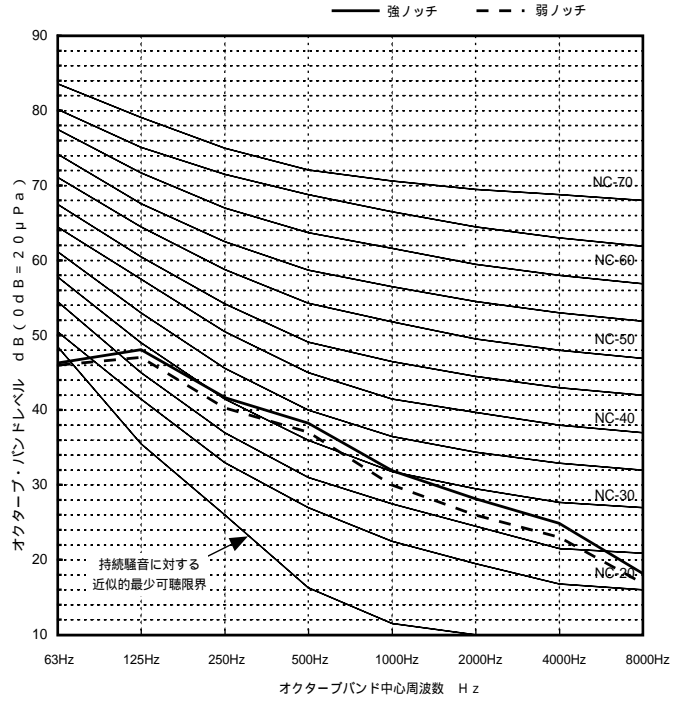

### PLFY-P71・80CLMD-E1形

	63Hz	125Hz	250Hz	500Hz	1000Hz	2000Hz	4000Hz	8000Hz	A特性計算
強ノッチ	44.5	48.5	44	40	34.5	32	28	20	42
弱ノッチ	43	46.5	41	37.5	31	27.5	24.5	16.5	39

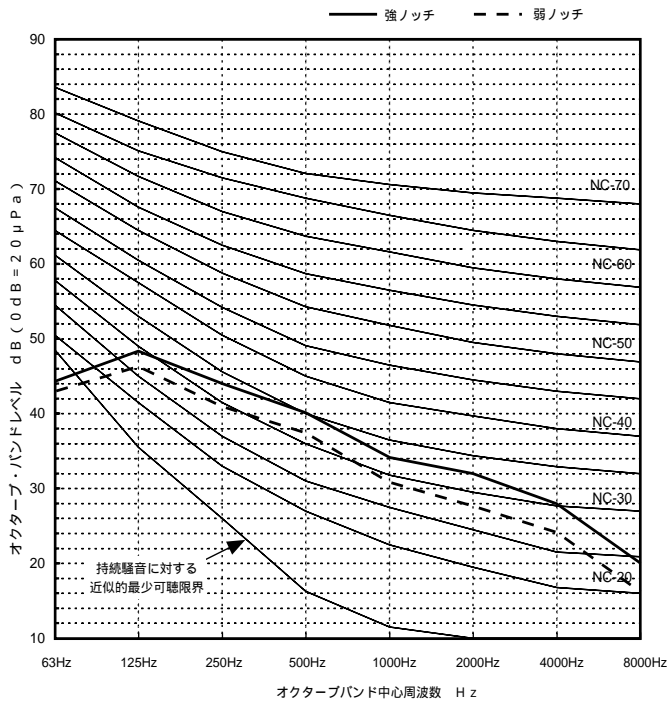

## 8. 重心位置

### (1) 室外ユニット

P140・P160・P224・P280・P335・P355・P400形

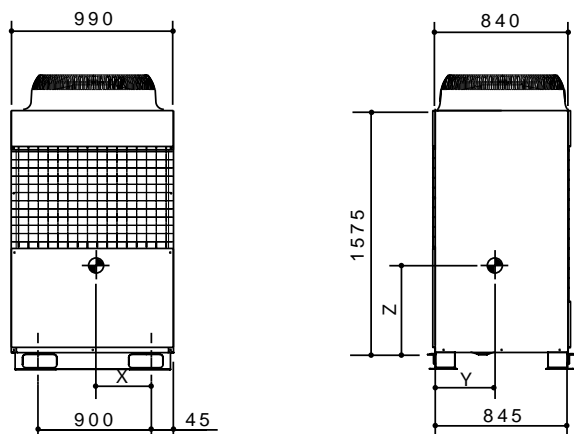

形名	X	Y	Z
PUHY-P140M-E	410	360	600
PUHY-P160M-E	410	360	600
PUHY-P224M-E	410	360	600
PUHY-P280M-E	405	375	615
PUHY-P335M-E	405	375	615
PUHY-P355M-E	405	375	615
PUHY-P400M-E	405	375	615

### P450形

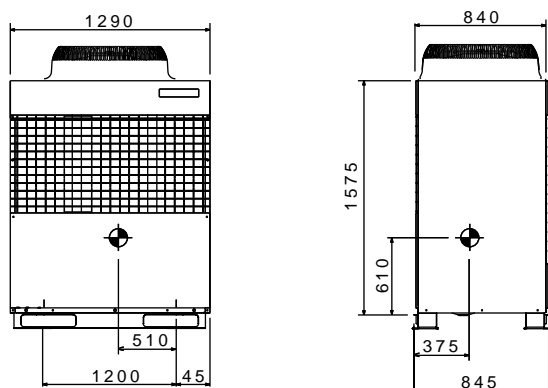

### P500・P560・P630・P674・P730形

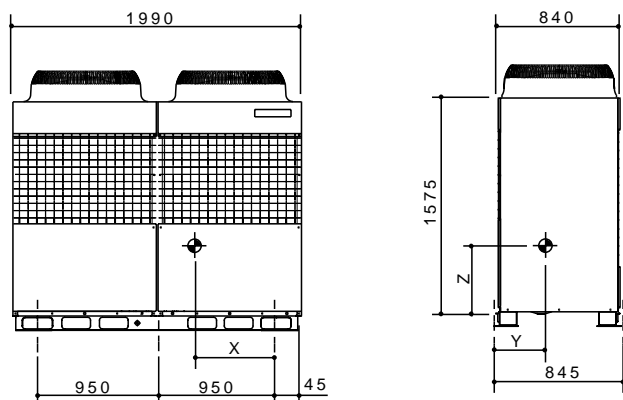

形名	X	Y	Z
PUHY-P500M-E	755	365	560
PUHY-P560M-E	755	365	560
PUHY-P630M-E	755	380	575
PUHY-P674M-E	755	380	575
PUHY-P730M-E	755	380	575

PUHY-P684 · P740 · P800SM-E形

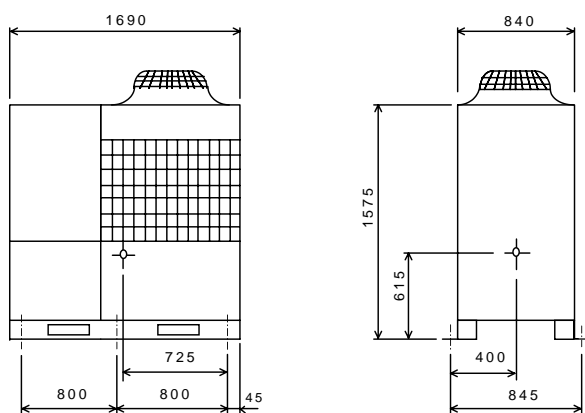

PVHN-P100SM-E形

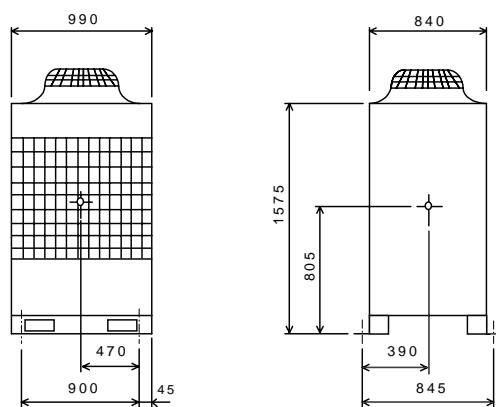

PUHY-P500 · P560 · P630 · P670 · P730SM-E形

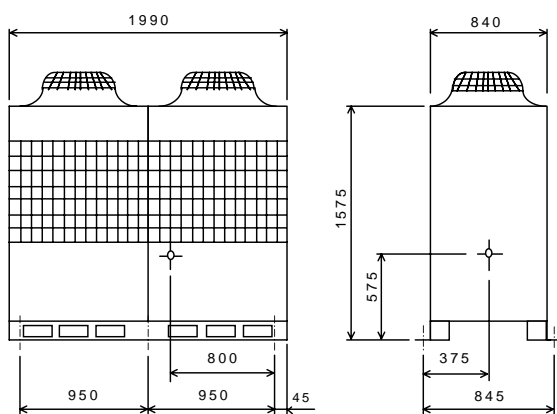

PUHY-P450 · P730KM-E形

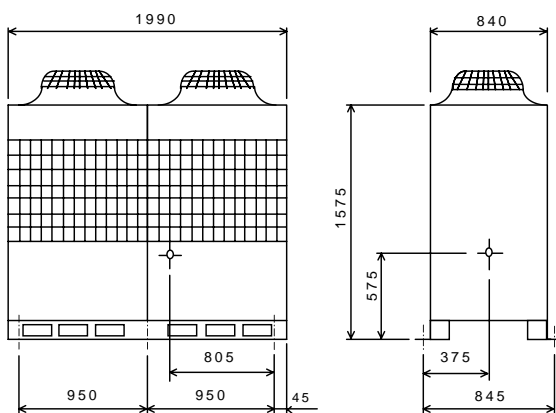

(2) 室内ユニット

PLFY-LMD-E1形

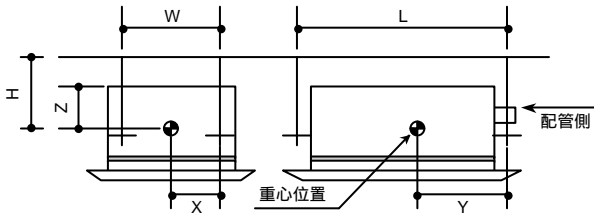

形名	W	L	X	Y	Z	H
PLFY-P22LMD-E1	574	824	287	370	160	172
PLFY-P28LMD-E1	574	824	287	370	160	172
PLFY-P36LMD-E1	574	824	287	370	160	172
PLFY-P45LMD-E1	574	824	287	370	160	172
PLFY-P56LMD-E1	574	994	287	445	160	172
PLFY-P71LMD-E1	574	994	287	445	160	172
PLFY-P80LMD-E1	574	1494	287	655	160	172
PLFY-P90LMD-E1	574	1494	287	655	160	172
PLFY-P112LMD-E1	574	1494	287	655	160	172
PLFY-P140LMD-E1	574	1756	287	758	181	203

PMFY-BM-E1形

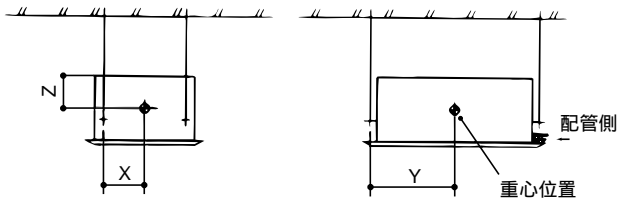

形名	X	Y	Z
PMFY-P22BM-E1	165	390	130
PMFY-P28BM-E1	165	390	130
PMFY-P36BM-E1	165	390	130
PMFY-P45BM-E1	165	390	130

PMFY-EM-E1形

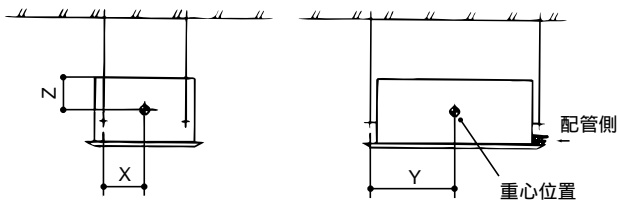

形名	X	Y	Z
PMFY-P36EM-E1	215	493.5	100
PMFY-P45EM-E1	215	493.5	100
PMFY-P56EM-E1	215	493.5	100
PMFY-P71EM-E1	205	682.5	100
PMFY-P80EM-E1	205	682.5	100

PDFY-M-E1形

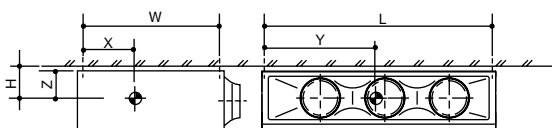

形名	W	L	H	X	Y	Z
PDFY-P22M-E1	670	686	148	285	343	128
PDFY-P28M-E1	670	686	148	285	343	128
PDFY-P36M-E1	670	686	148	285	343	128
PDFY-P45M-E1	670	936	148	285	468	128
PDFY-P56M-E1	670	936	148	285	468	128
PDFY-P71M-E1	670	1136	148	285	568	128
PDFY-P80M-E1	670	1136	148	285	568	128
PDFY-P90M-E1	670	1136	148	285	568	128
PDFY-P112M-E1	710	1486	168	305	743	148
PDFY-P140M-E1	710	1486	168	305	743	148

PEFY-AM-E1形

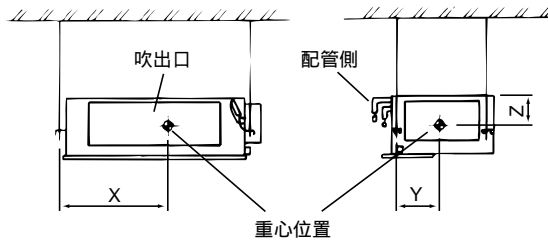

形名	X	Y	Z
PEFY-P22AM-E1	410	170	110
PEFY-P28AM-E1	410	170	110
PEFY-P36AM-E1	410	170	110

PEFY-M-E1形

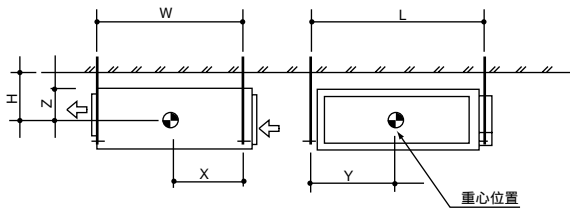

形名	W	L	H	X	Y	Z
PEFY-P45M-E1	814	754	210	374	440	190
PEFY-P56M-E1	814	754	210	374	440	190
PEFY-P71M-E1	814	754	210	374	440	190
PEFY-P80M-E1	814	1004	210	394	584	190
PEFY-P90M-E1	814	1004	210	394	584	190
PEFY-P112M-E1	814	1204	210	364	649	190
PEFY-P140M-E1	814	1204	210	364	649	190
PEFY-P160M-E1	814	1204	210	364	649	190
PEFY-P224M-E1	1034	1326	255	462	660	235
PEFY-P280M-E1	1034	1326	255	462	660	235

PCFY-GM-E1形

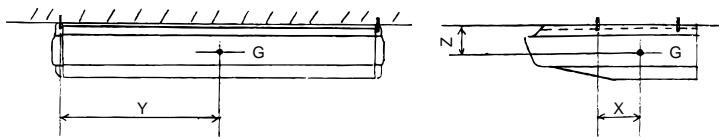

形名	X	Y	Z
PCFY-P56GM-E1	130	470	120
PCFY-P80GM-E1	110	600	140
PCFY-P112GM-E1	110	580	145
PCFY-P140GM-E1	80	710	140
PCFY-P160GM-E1	90	750	160

PFFY-LEM-E1形

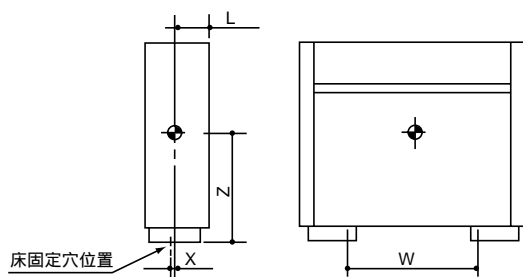

形名	W	L	X	Z
PFFY-P28LEM-E1	640	100	17	335
PFFY-P36LEM-E1	760	100	17	335
PFFY-P45LEM-E1	760	100	17	335
PFFY-P56LEM-E1	1000	100	17	335
PFFY-P71LEM-E1	1000	100	17	335

PFFY-LRM-E1形

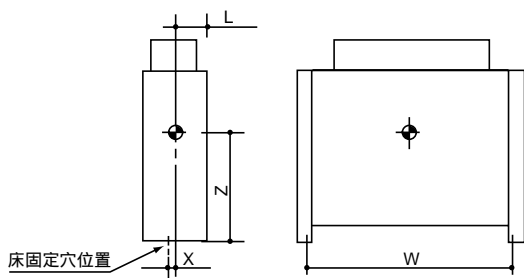

形名	W	L	X	Z
PFFY-P28LRM-E1	640	100	17	335
PFFY-P36LRM-E1	760	100	17	335
PFFY-P45LRM-E1	760	100	17	335
PFFY-P56LRM-E1	1000	100	17	335
PFFY-P71LRM-E1	1000	100	17	335

PFFY-DM-E1形

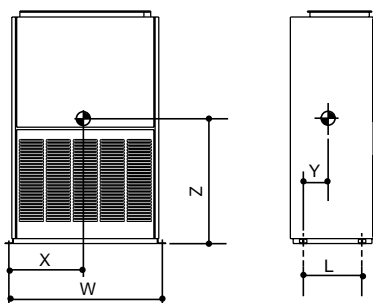

形名	W	L	X	Y	Z
PFFY-P224DM-E1	1014	300	467	158	809
PFFY-P280DM-E1	1234	300	573	156	835
PFFY-P450DM-E1	1230	440	567	225	1017
PFFY-P560DM-E1	1450	440	647	225	1017

PSFY-GM-E1形

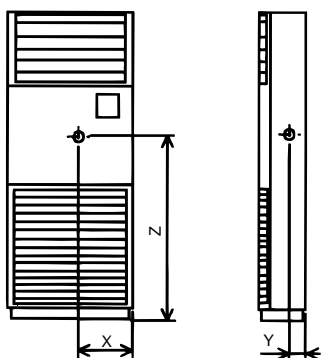

形名	X	Y	Z
PSFY-P56GM-E1	295	120	940
PSFY-P80GM-E1	295	115	960
PSFY-P112GM-E1	295	160	930
PSFY-P160GM-E1	295	155	930

PFFY-RM-E1形

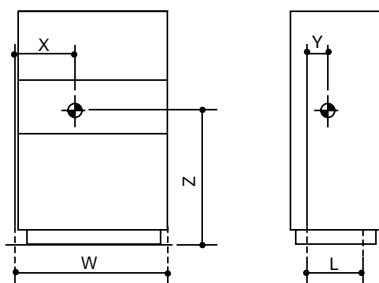

形名	W	L	X	Y	Z
PFFY-P112RM-E1	1022	320	465	125	1110
PFFY-P140RM-E1	1022	320	465	125	1110
PFFY-P224RM-E1	1242	320	570	125	1110
PFFY-P280RM-E1	1482	320	685	125	1110

PEFY-ML-E(-R)形

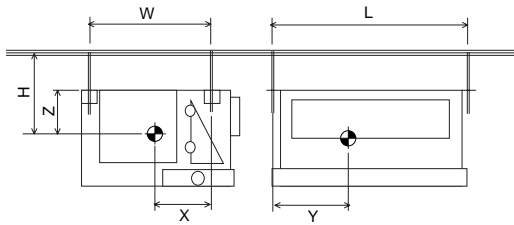

形名	W	L	H	X	Y	Z
PEFY-P22·28ML-E(-R)	439	584	170	210	250	150

PCFY-HM-E1形

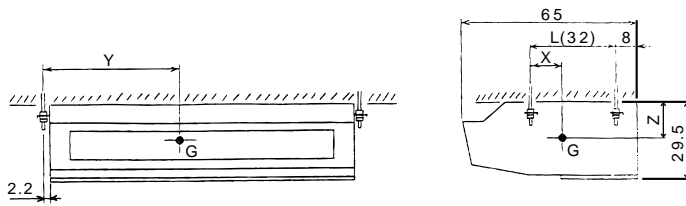

形名	X	Y	Z
PCFY-P80HM-E1	125	575	170
PCFY-P140HM-E1	95	765	150

PEFY-M-E1-F形

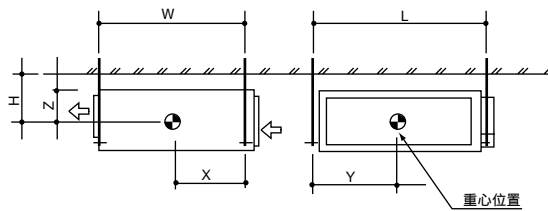

形名	W	L	H	X	Y	Z
PEFY-P90M-E1-F	814	1004	210	394	584	190
PEFY-P112M-E1-F	814	1204	210	364	649	190
PEFY-P140M-E1-F	814	1204	210	364	649	190
PEFY-P160M-E1-F	814	1204	210	364	649	190
PEFY-P224M-E1-F	1034	1326	255	462	660	235
PEFY-P280M-E1-F	1034	1326	255	462	660	235

PFFY-RM-E1-F形

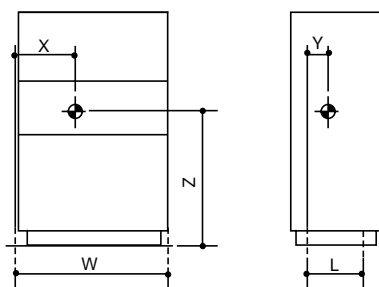

形名	W	L	X	Y	Z
PFFY-P280RM-E1-F	1482	320	685	125	1110

PLFY-CLMD-E1形

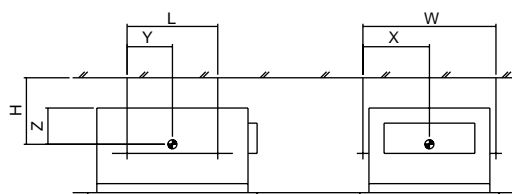

形名	W	L	H	X	Y	Z
PLFY-P36CLMD-E1	880	950	270	484	490	250
PLFY-P45·56CLMD-E1	1035	950	270	570	490	250
PLFY-P71·80CLMD-E1	1340	950	270	737	490	250



## 9.耐震強度計算

### (1) 耐震強度計算書フォーム

室外ユニット用・熱源ユニット用フォーム

### 耐震強度計算書

1. 機種

2. 形名

#### 3. 機器緒元

(1) 機器質量 (運転質量)  $W =$   kg

#### (2) アンカーボルト

総本数  $N =$   本

サイズ・形状  $= M$   形

1本当たりの軸断面積 (呼径による断面積)  $A =$    $\text{mm}^2 =$    $\times 10^{-6}$   $\text{m}^2$

機器転倒を考えた場合の引張りを受ける片側のアンカーボルトの総本数  $N_t =$   本

(3) 据付面より機器重心までの高さ  $H_g =$   mm  $=$   ' m

(4) 検討する方向から見たボルトスパン  $L =$   mm  $=$   ' m

(5) 検討する方向から見たボルト中心から機器重心までの距離  $L_g =$   mm ( $L_g = L/2$ )  $=$   ' m

#### 4. 検討計算 (各頁の小数点以下2桁目を四捨五入して算出)

(1) 設計用水平震度  $K_h =$   2.0

(2) 設計用鉛直震度  $K_v = K_h / 2 =$   1.0

(3) 設計用水平地震力  $F_h = K_h \cdot W \cdot 9.8 =$   N

(4) 設計用鉛直地震力  $F_v = K_v \cdot W \cdot 9.8 =$   N

(5) アンカーボルトの引抜力  $R_b = \frac{F_h \cdot H_g - (W \cdot 9.8 - F_v) \cdot L_g}{L \cdot N_t} =$   N

(6) アンカーボルトのせん断力  $Q = \frac{F_h}{N} =$   N

#### (7) アンカーボルトに生ずる応力度

引張り応力度  $= \frac{R_b}{A} =$   MPa  $< f_t = 176.4$  MPa

せん断応力度  $= \frac{Q}{A} =$   MPa  $< f_s = 132.3$  MPa

引張りとせん断を同時に受ける場合  $f_{ts} \approx 1.4f_t - 1.6 =$   MPa

ただし、 $f_{ts} < f_t$ のとき  $f_{ts} = f_t$  ;  $f_{ts} > f_t$ のとき  $f_{ts} = f_t$  であるので  $f_{ts} =$   176.4 MPa

$=$   MPa  $< f_{ts} =$   176.4 MPa

#### (8) アンカーボルトの施工法

アンカーボルトの施工法  $=$   箱抜き式 J 形アンカー

コンクリートの厚さ  $=$   mm  $=$   ' m

ボルトの埋込長さ  $=$   mm  $=$   ' m

許容引抜荷重  $T_a =$   N  $> R_b =$   ' N

以上の検討計算書より、アンカーボルトは十分な強度を有する。

(2) 耐震強度計算

ECOシリーズ(新冷媒)

機種			ECOシリーズ(新冷媒)					
機器形名			PUHY-P140M-E	PUHY-P160M-E	PUHY-P224M-E	PUHY-P280M-E	PUHY-P335M-E	PUHY-P355M-E
機器質量(kg)		W	215	215	215	230	230	230
アン カ ー ボ ルト	総本数	N	4	4	4	4	4	4
	引張りを受けるボルト総本数	Nt	2	2	2	2	2	2
	機器重心までの高さ(mm)	Hg	600	600	600	615	615	615
	" (m)	Hg	0.600	0.600	0.600	0.615	0.615	0.615
	ボルトスパン(mm)	L	845	845	845	845	845	845
	" (m)	L	0.845	0.845	0.845	0.845	0.845	0.845
	機器重心までの距離(mm)	Lg	360	360	360	375	375	375
	" (m)	Lg	0.360	0.360	0.360	0.375	0.375	0.375
検 討 計 算 書	水平地震力(N)	Fh	4214.0	4214.0	4214.0	4508.0	4508.0	4508.0
	鉛直地震力(N)	Fv	2107.0	2107.0	2107.0	2254.0	2254.0	2254.0
	引抜き力(N)	Rb	1496.1	1496.1	1496.1	1640.5	1640.5	1640.5
	せん断力(N)	Q	1053.5	1053.5	1053.5	1127.0	1127.0	1127.0
	引張応力度(MPa)		19.2	19.2	19.2	21.0	21.0	21.0
	せん断応力度(MPa)		13.5	13.5	13.5	14.4	14.4	14.4
	同時応力度(MPa)	fts'	225.4	225.4	225.4	223.9	223.9	223.9
	コンクリート厚さ(mm)		180	180	180	180	180	180
	" (m)		0.180	0.180	0.180	0.180	0.180	0.180
	ボルトの埋込長さ(mm)		130	130	130	130	130	130
	" (m)		0.130	0.130	0.130	0.130	0.130	0.130
	許容引抜荷重(N)	Ta	5488	5488	5488	5488	5488	5488

機種			ECOシリーズ(新冷媒)						
機器形名			PUHY-P400M-E	PUHY-P450M-E	PUHY-P500M-E	PUHY-P560M-E	PUHY-P630M-E	PUHY-P674M-E	PUHY-P730M-E
機器質量(kg)		W	230	270	420	420	450	450	450
アン カ ー ボ ルト	総本数	N	4	4	6	6	6	6	6
	引張りを受けるボルト総本数	Nt	2	2	3	3	3	3	3
	機器重心までの高さ(mm)	Hg	615	610	560	560	575	575	575
	" (m)	Hg	0.615	0.610	0.560	0.560	0.575	0.575	0.575
	ボルトスパン(mm)	L	845	845	845	845	845	845	845
	" (m)	L	0.845	0.845	0.845	0.845	0.845	0.845	0.845
	機器重心までの距離(mm)	Lg	375	375	365	365	380	380	380
	" (m)	Lg	0.375	0.375	0.365	0.365	0.380	0.380	0.380
検 討 計 算 書	水平地震力(N)	Fh	4508.0	5292.0	8232.0	8232.0	8820.0	8820.0	8820.0
	鉛直地震力(N)	Fv	2254.0	2646.0	4116.0	4116.0	4410.0	4410.0	4410.0
	引抜き力(N)	Rb	1640.5	1910.1	1818.5	1818.5	2000.6	2000.6	2000.6
	せん断力(N)	Q	1127.0	1323.0	1372.0	1372.0	1470.0	1470.0	1470.0
	引張応力度(MPa)		21.0	24.5	23.3	23.3	25.6	25.6	25.6
	せん断応力度(MPa)		14.4	17.0	17.6	17.6	18.8	18.8	18.8
	同時応力度(MPa)	fts'	223.9	219.8	218.8	218.8	216.9	216.9	216.9
	コンクリート厚さ(mm)		180	180	180	180	180	180	180
	" (m)		0.180	0.180	0.180	0.180	0.180	0.180	0.180
	ボルトの埋込長さ(mm)		130	130	130	130	130	130	130
	" (m)		0.130	0.130	0.130	0.130	0.130	0.130	0.130
	許容引抜荷重(N)	Ta	5488	5488	5488	5488	5488	5488	5488

ECOシリーズ (新冷媒)

機 種			ECOシリーズ(新冷媒)			
機器形名			PUHY-P684SM-E	PUHY-P740SM-E	PUHY-P800SM-E	PVHN-P100SM-E
機器質量(kg)		W	430	430	430	155
ア ン カ ー ボ ルト	総本数	N	6	6	6	4
	引張りを受けるボルト総本数	Nt	3	3	3	2
	機器重心までの高さ(mm)	Hg	615	615	615	805
	"          (m)	Hg	0.615	0.615	0.615	0.805
	ボルトスパン(mm)	L	845	845	845	845
	"          (m)	L	0.845	0.845	0.845	0.845
	機器重心までの距離(mm)	Lg	400	400	400	390
	"          (m)	Lg	0.400	0.400	0.400	0.390
検 討 計 算 書	水平地震力(N)	Fh	8428.0	8428.0	8428.0	3038.0
	鉛直地震力(N)	Fv	4214.0	4214.0	4214.0	1519.0
	引抜き力(N)	Rb	2044.7	2044.7	2044.7	1447.1
	せん断力(N)	Q	1404.7	1404.7	1404.7	759.5
	引張応力度(MPa)		26.2	26.2	26.2	18.6
	せん断応力度(MPa)		18.0	18.0	18.0	9.7
	同時応力度(MPa)	fts'	218.2	218.2	218.2	231.4
	コンクリート厚さ(mm)		180	180	180	180
	"          (m)		0.180	0.180	0.180	0.180
	ボルトの埋込長さ(mm)		130	130	130	130
	"          (m)		0.130	0.130	0.130	0.130
	許容引抜荷重(N)	Ta	5488	5488	5488	5488

機 種			ECOシリーズ(新冷媒)						
機器形名			PUHY-P500SM-E	PUHY-P560SM-E	PUHY-P630SM-E	PUHY-P670SM-E	PUHY-P730SM-E	PUHY-P450KM-E	PUHY-P730KM-E
機器質量(kg)		W	458	458	458	458	458	460	460
ア ン カ ー ボ ルト	総本数	N	6	6	6	6	6	6	6
	引張りを受けるボルト総本数	Nt	3	3	3	3	3	3	3
	機器重心までの高さ(mm)	Hg	575	575	575	575	575	575	575
	"          (m)	Hg	0.575	0.575	0.575	0.575	0.575	0.575	0.575
	ボルトスパン(mm)	L	845	845	845	845	845	845	845
	"          (m)	L	0.845	0.845	0.845	0.845	0.845	0.845	0.845
	機器重心までの距離(mm)	Lg	375	375	375	375	375	375	375
	"          (m)	Lg	0.375	0.375	0.375	0.375	0.375	0.375	0.375
検 討 計 算 書	水平地震力(N)	Fh	8976.8	8976.8	8976.8	8976.8	8976.8	9016.0	9016.0
	鉛直地震力(N)	Fv	4488.4	4488.4	4488.4	4488.4	4488.4	4508.0	4508.0
	引抜き力(N)	Rb	2036.2	2036.2	2036.2	2036.2	2036.2	2045.0	2045.0
	せん断力(N)	Q	1496.1	1496.1	1496.1	1496.1	1496.1	1502.7	1502.7
	引張応力度(MPa)		26.1	26.1	26.1	26.1	26.1	26.2	26.2
	せん断応力度(MPa)		19.2	19.2	19.2	19.2	19.2	19.3	19.3
	同時応力度(MPa)	fts'	216.2	216.2	216.2	216.2	216.2	216.1	216.1
	コンクリート厚さ(mm)		180	180	180	180	180	180	180
	"          (m)		0.180	0.180	0.180	0.180	0.180	0.180	0.180
	ボルトの埋込長さ(mm)		130	130	130	130	130	130	130
	"          (m)		0.130	0.130	0.130	0.130	0.130	0.130	0.130
	許容引抜荷重(N)	Ta	5488	5488	5488	5488	5488	5488	5488

## 10. 室外ユニットの振動レベル

### PUHY-P140～P450M-E形

#### (1) 測定条件

測定周波数帯：1Hz～80Hz  
 測定位置：ユニット脚部より20cmの距離の路面  
 据付状態：コンクリート床面直置

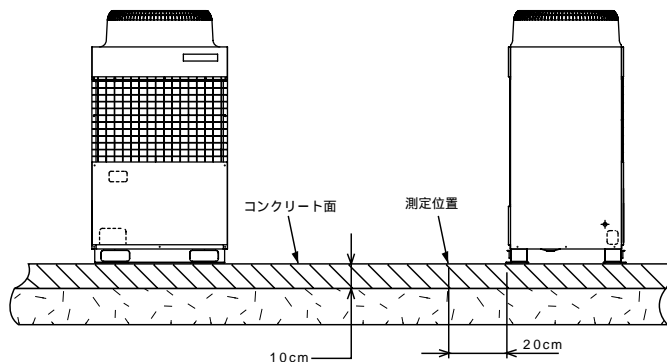

電源：三相200V 50Hz/60Hz  
 運転条件：JIS条件（冷房、暖房）  
 測定器機：公害用振動レベル計 VM-1220C（JIS適合品）

#### (2) 振動レベル値

形名	振動レベル値(dB[A特性])
PUHY-P140M-E(-BS,-BSG)	44
PUHY-P160M-E(-BS,-BSG)	44
PUHY-P224M-E(-BS,-BSG)	45
PUHY-P280M-E(-BS,-BSG)	46
PUHY-P335M-E(-BS,-BSG)	47
PUHY-P355M-E(-BS,-BSG)	47
PUHY-P400M-E(-BS,-BSG)	47
PUHY-P450M-E(-BS,-BSG)	47

(注) 上記値は、暗振動補正を行ったものである。

### PUHY-P500～P730M-E形

#### (1) 測定条件

測定周波数帯：1Hz～80Hz  
 測定位置：ユニット脚部より20cmの距離の路面  
 据付状態：コンクリート床面直置

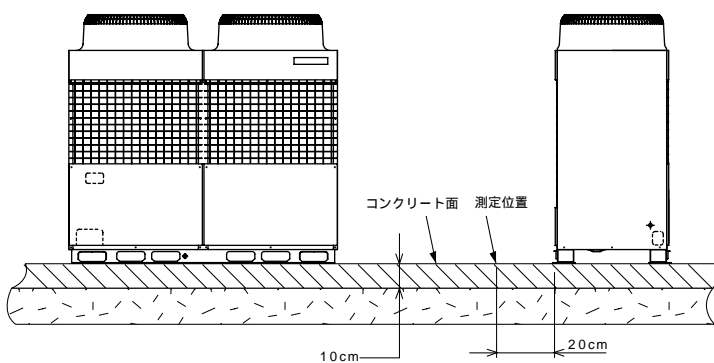

電源：三相200V 50Hz/60Hz  
 運転条件：JIS条件（冷房、暖房）  
 測定器機：公害用振動レベル計 VM-1220C（JIS適合品）

#### (2) 振動レベル値

形名	振動レベル値(dB[A特性])
PUHY-P500M-E(-BS,-BSG)	49
PUHY-P560M-E(-BS,-BSG)	49
PUHY-P630M-E(-BS,-BSG)	49
PUHY-P674M-E(-BS,-BSG)	49
PUHY-P730M-E(-BS,-BSG)	49

(注) 上記値は、暗振動補正を行ったものである。

## PUHY-P784 ~ P900SM-E形

### (1) 測定条件

測定周波数帯：1Hz～80Hz  
 測定位置：ユニット脚部より20cmの距離の路面  
 据付状態：コンクリート床面直置

### (2) 振動レベル値

形名	振動レベル値(dB[A特性])
PUHY-P784SM-E(-BS,-BSG)	50
PUHY-P840SM-E(-BS,-BSG)	50
PUHY-P900SM-E(-BS,-BSG)	51

注：上記値は、暗振動補正を行ったものである。

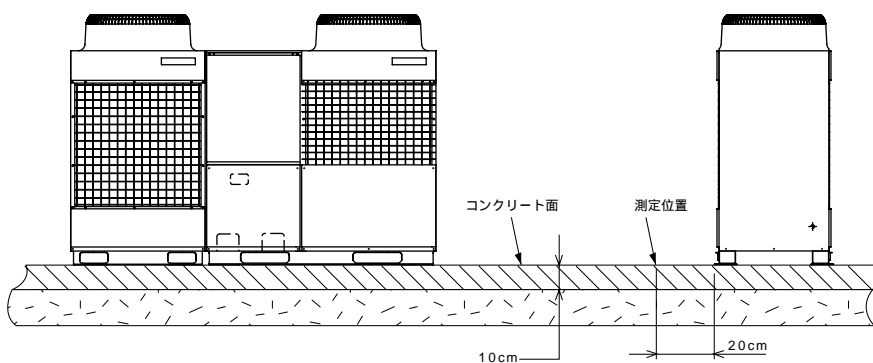

電源：三相200V 50Hz/60Hz  
 運転条件：JIS条件（冷房、暖房）  
 測定器機：公害用振動レベル計 VM-1220C（JIS適合品）

## PUHY-P960 ~ P1400SKM-E形

### (1) 測定条件

測定周波数帯：1Hz～80Hz  
 測定位置：ユニット脚部より20cmの距離の路面  
 据付状態：コンクリート床面直置

### (2) 振動レベル値

形名	振動レベル値(dB[A特性])
PUHY-P960SKM-E(-BS,-BSG)	52
PUHY-P1010SKM-E(-BS,-BSG)	52
PUHY-P1080SKM-E(-BS,-BSG)	52
PUHY-P1130SKM-E(-BS,-BSG)	52
PUHY-P1180SKM-E(-BS,-BSG)	52
PUHY-P1240SKM-E(-BS,-BSG)	52
PUHY-P1300SKM-E(-BS,-BSG)	52
PUHY-P1360SKM-E(-BS,-BSG)	52
PUHY-P1400SKM-E(-BS,-BSG)	52

(注) 上記値は、暗振動補正を行ったものである。

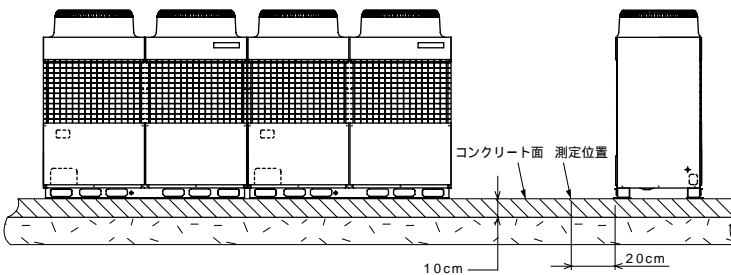

電源：三相200V 50Hz/60Hz  
 運転条件：JIS条件（冷房、暖房）  
 測定器機：公害用振動レベル計 VM-1220C（JIS適合品）

# 据付工事

## 1. 室外ユニットの据付け

### (1) 製品の吊下げ方法

- ・製品を吊下げて搬入する場合はロープをユニットの下に通し、前後各2ヶ所の吊り部を使用してください。
- ・ロープは必ず4ヶ所吊りとし、ユニットに衝撃を与えないようにしてください。
- ・ロープ掛けの角度は下図のように40°以下にしてください。
- ・ロープは8m以上のものを2本使用してください。

PUHY-P140・P160・P224・P280・P335・P355・P400・P450M-E形

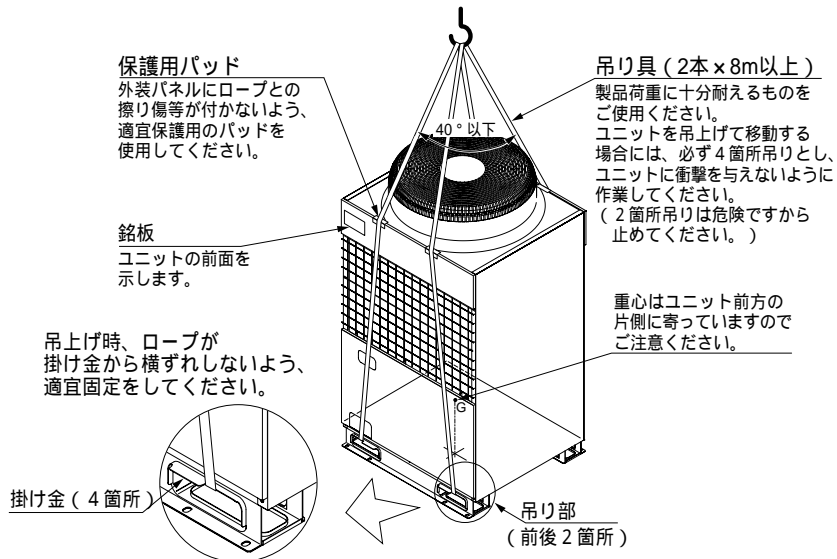

PUHY-P500・P560・P630・P674・P730M-E形

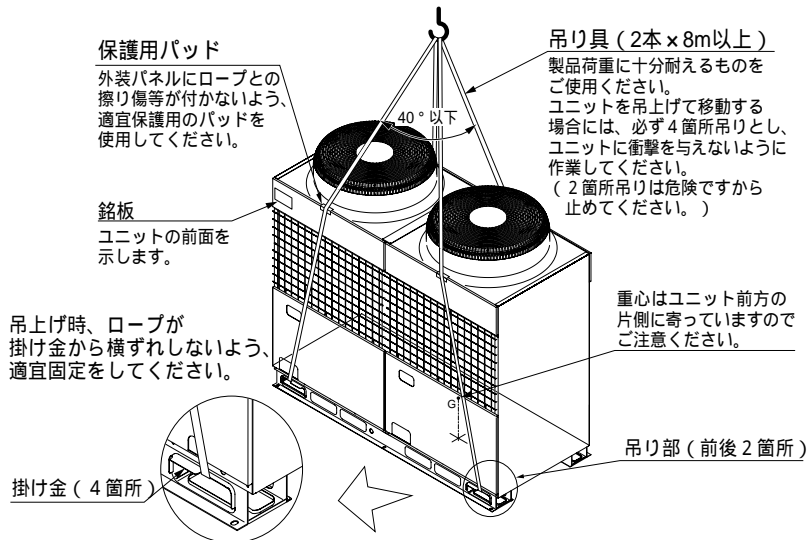

### ⚠ 注意

製品の運搬には、十分注意してください。

- ・20kg以上の製品の運搬は、1人で行わないでください。
- ・製品によってはPPバンドによる梱包を行っていますが、危険ですので運搬の手段には使用しないでください。
- ・熱交換器のフィン表面で切傷する場合がありますので、素手で触れないように注意してください。
- ・包装用のポリブクロで子どもが遊ばないように、破いてから廃棄してください。窒息事故などの原因となります。
- ・室外ユニットの搬入を行う場合は、ユニットベースの指定位置に吊下げてください。また、適宜、室外ユニットが横ずれしないよう固定し、確実に4点支持で実施してください。3点支持以下で運搬・吊下げしますと不安定となり、落下の原因となります。

PUHY-P684・P740・P800SM-E形

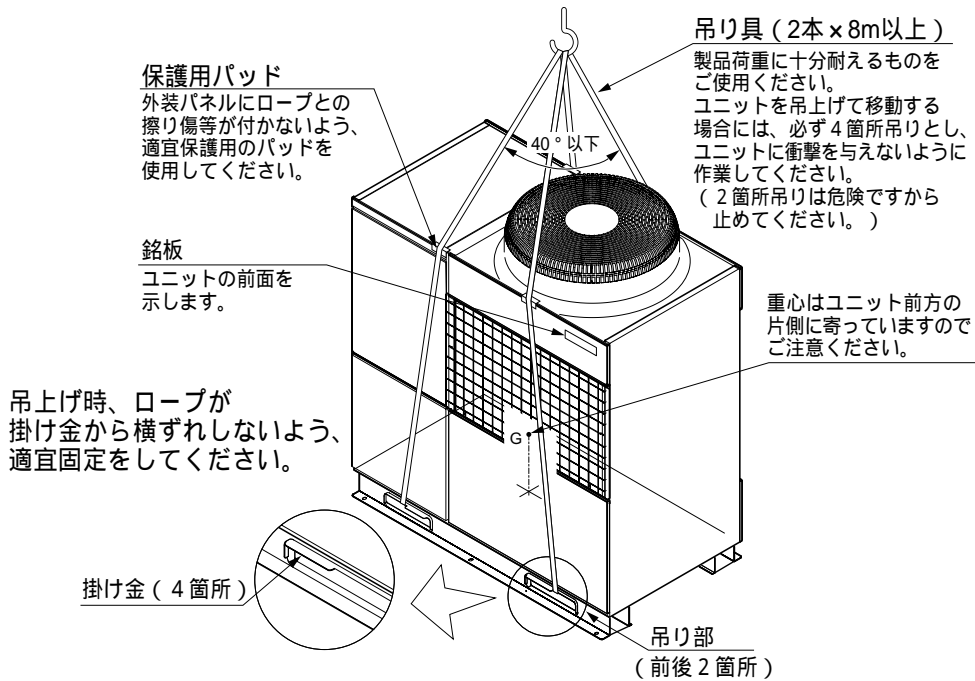

PVHN-P100SM-E形

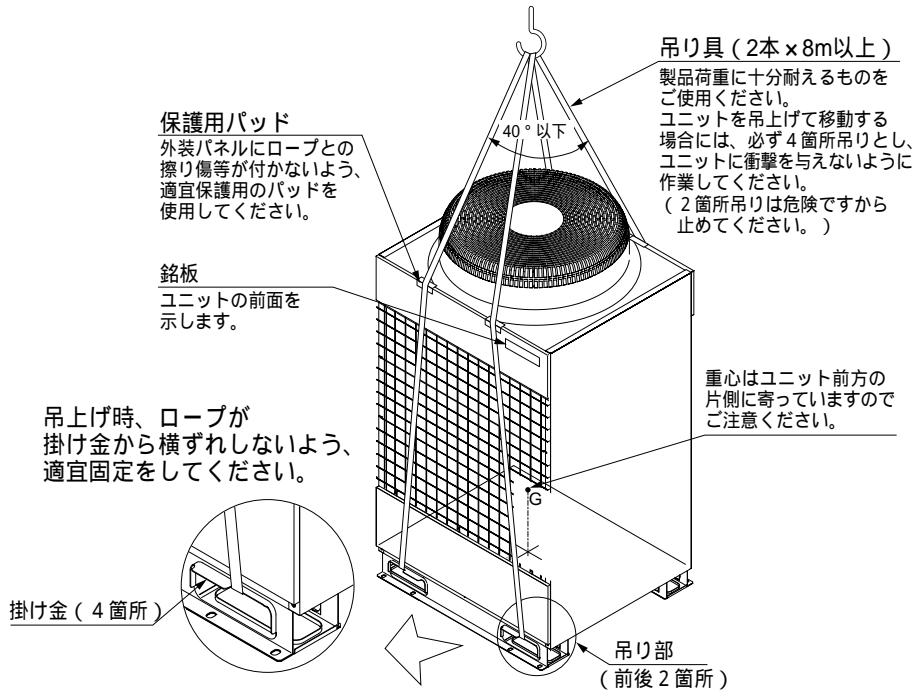

注意

製品の運搬には、十分注意してください。

- ・20kg以上の製品の運搬は、1人で行わないでください。
- ・製品によってはPPバンドによる梱包を行っていますが、危険ですので運搬の手段には使用しないでください。
- ・熱交換器のフィン表面で切傷する場合がありますので、素手で触れないように注意してください。
- ・包装用のポリブクロで子どもが遊ばないように、破いてから廃棄してください。窒息事故などの原因となります。
- ・室外ユニットの搬入を行う場合は、ユニットベースの指定位置に吊下げてください。また、適宜、室外ユニットが横ずれしないよう固定し、確実に4点支持で実施してください。3点支持以下で運搬・吊下げしますと不安定となり、落下の原因となります。

PUHY-P500・P560・P630・P670・P730SM-E形

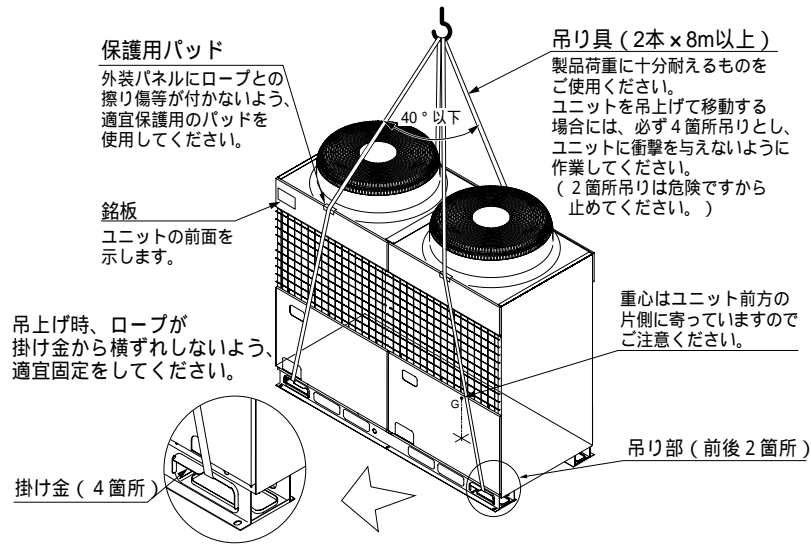

PUHY-P450・P730KM-E形

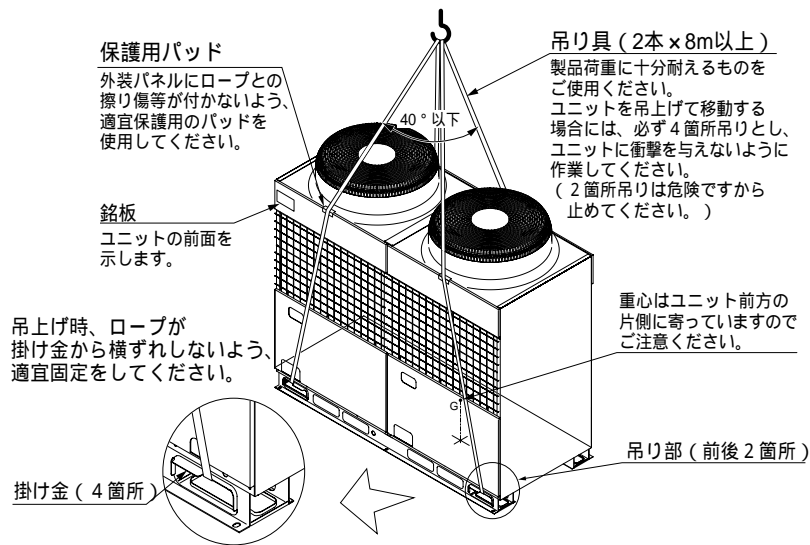

**⚠ 注意**

製品の運搬には、十分注意してください。

- ・20kg以上の製品の運搬は、1人で行わないでください。
- ・製品によってはPPバンドによる梱包を行っていますが、危険ですので運搬の手段には使用しないでください。
- ・熱交換器のフィン表面で切傷する場合がありますので、素手で触れないように注意してください。
- ・包装用のポリブクロで子どもが遊ばないように、破いてから廃棄してください。窒息事故などの原因となります。
- ・室外ユニットの搬入を行う場合は、ユニットベースの指定位置に吊下げてください。また、適宜、室外ユニットが横ずれしないよう固定し、確実に4点支持で実施してください。3点支持以下で運搬・吊下げしますと不安定となり、落下の原因となります。



## (2) 据付け

- ・ユニットが地震や突風などで倒れないように、下図のようにボルトで強固に固定してください。
- ・ユニットの基礎は、コンクリートまたはアングル等の強固な基礎としてください。
- ・据付条件によっては、振動が据付部から伝搬し、床や壁面から、騒音や振動が発生する場合がありますので、十分な防振工事(防振パッド、防振架台など)を行ってください。

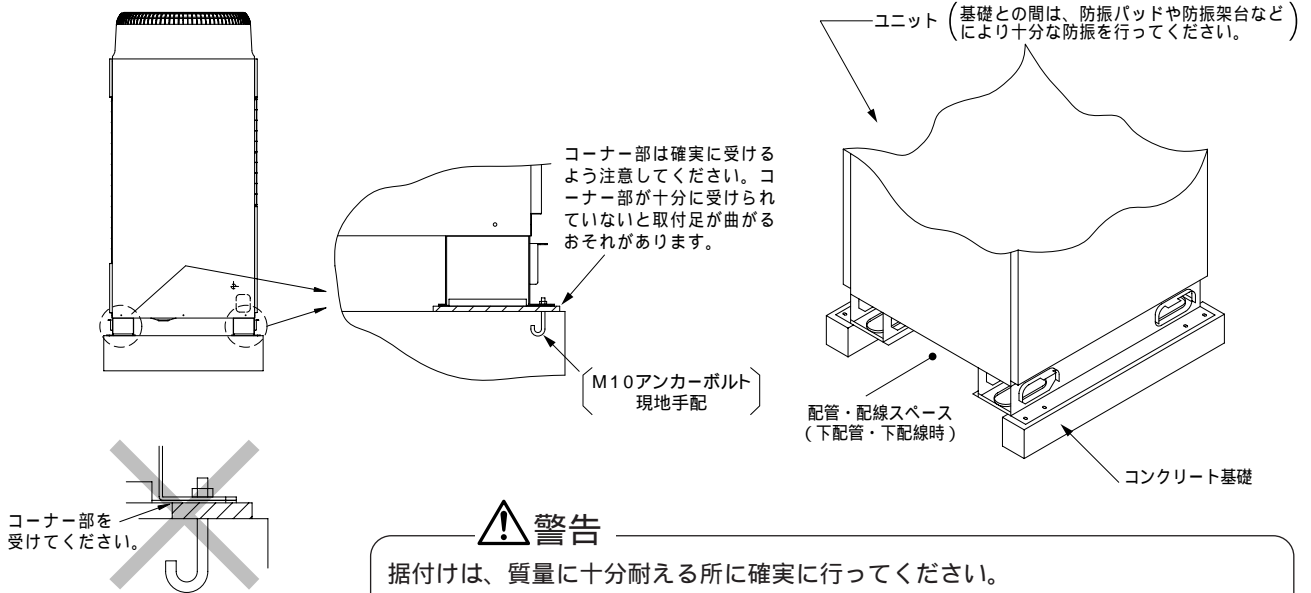

### 警告

据付けは、質量に十分耐える所に確実に行ってください。  
強度が不足している場合には、ユニット落下によりけがの原因になります。

### 警告

台風等の強風、地震に備え、所定の据付工事を行ってください。  
据付工事に不備があると、転倒等による事故の原因になります。

基礎施工に際しましては床面強度、ドレン水処理 運転時にはドレン水が機外に流出します、配管、配線の経路に十分留意してください。

## (3) アンカーボルト位置

PUHY-P140・P160・P224・P280・P335・P355・P400・P450M-E形

単独設置

集中設置例

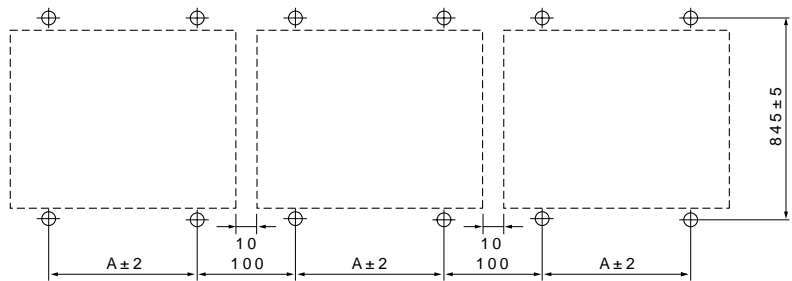
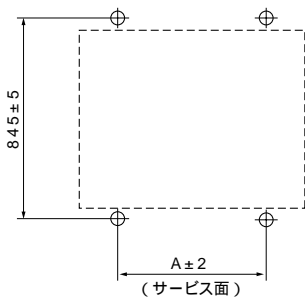

集中設置時、ユニット間には10mmのすきまを設けてください。

	P140~400形	P450形
A寸法	900	1200

## PUHY-P500・P560・P630・P674・P730M-E形

### 単独設置例

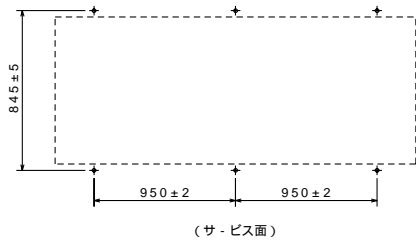

### 集中設置例

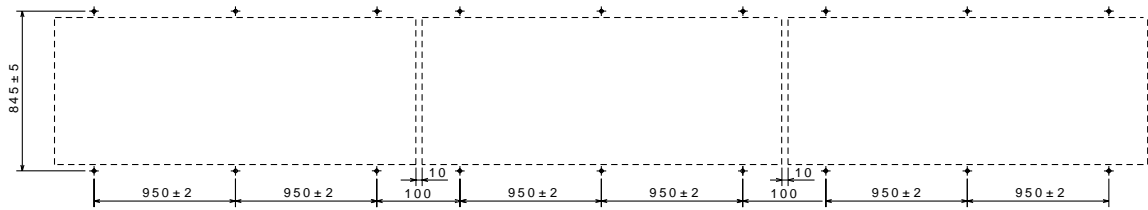

集中設置時、ユニット間には10mmのすきまを設けてください。

## PUHY-P784・P840・P900SM-E形

### 単独設置

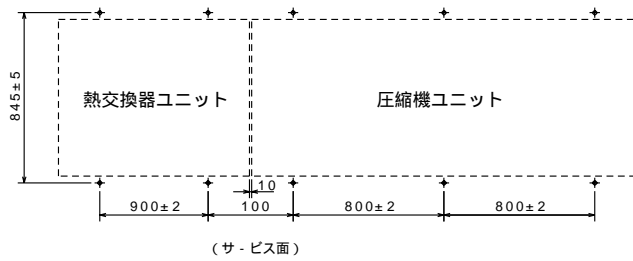

### 集中設置例

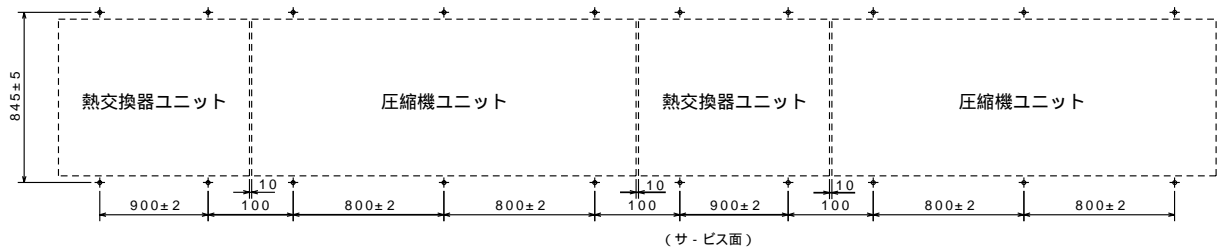

# PUHY-P960 ~ P1400SKM-E形

## 単独設置

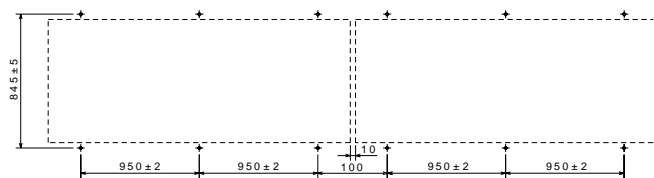

(サ・ビス面) ユニット間には10mmのすきまを設けてください。

## 集中設置例

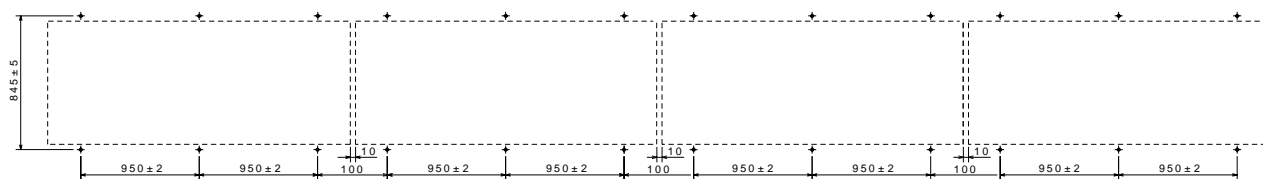

ユニット間には10mmのすきまを設けてください。

#### (4) 下配管・下配線時の注意

下配管または下配線を行う場合は、ベースの貫通穴を塞がないように基礎や架台の施工には注意してください。また、下配管する時にはユニットの底下に配管が通るように100mm以上の高さの基礎を設けてください。

#### PUHY-P140・P160・P224・P280・P335・P355・P400・P450M-E形

##### ・P140～P400形の場合

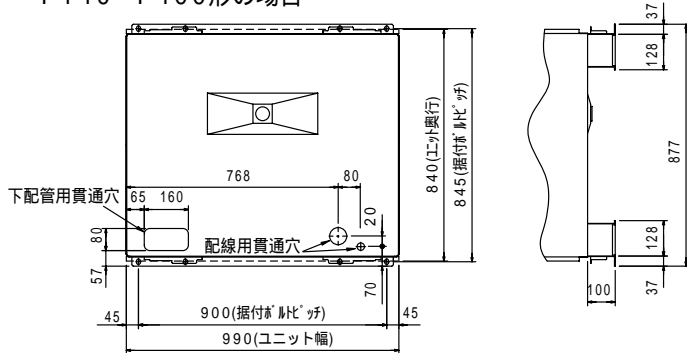

単位(mm)

下図のような基礎や架台の施工の場合には、貫通穴が塞がれるため、下配管および下配線ができなくなります。

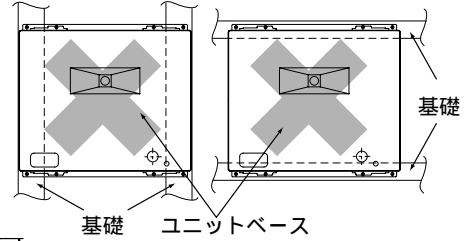

##### ・P450形の場合

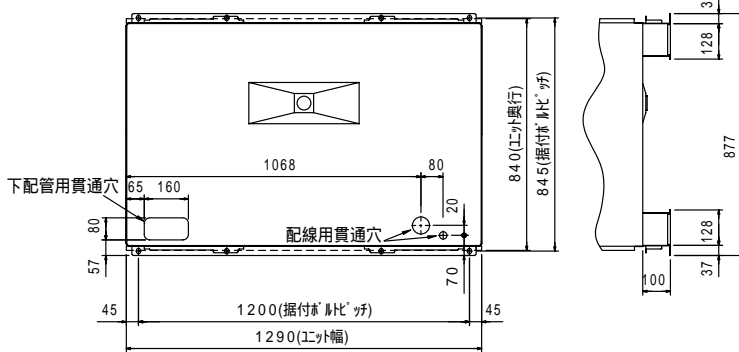

#### PUHY-P500・P560・P630・P674・P730M-E形

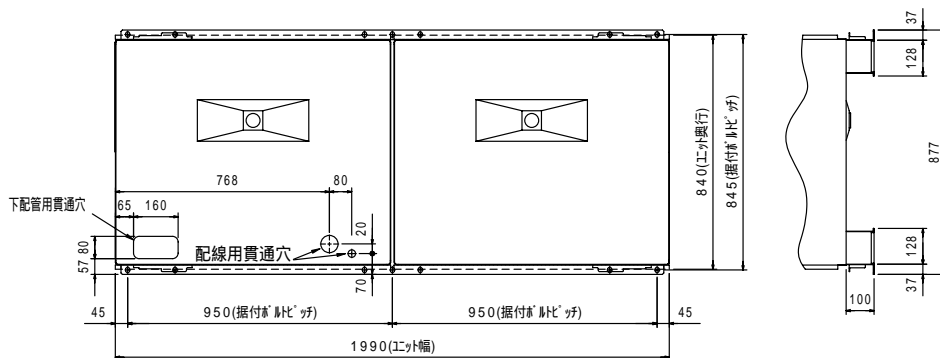

PUHY-P784・P840・P900SM-E形

・PVHN-P100SM-Eの場合

・PUHY-P684・P740・P800SM-Eの場合

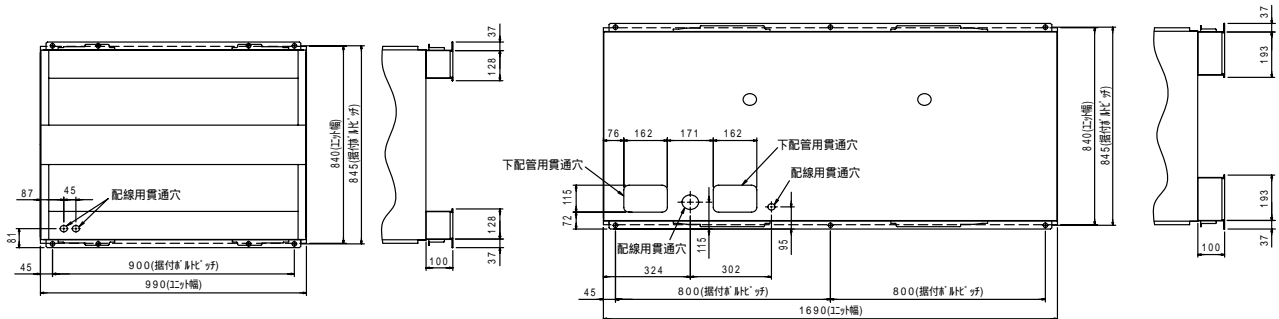

PUHY-P960 ~ P1400SKM-E形

・PUHY-P500・P560・P630・P670・P730SM-Eの場合

・PUHY-P450・P730KM-Eの場合

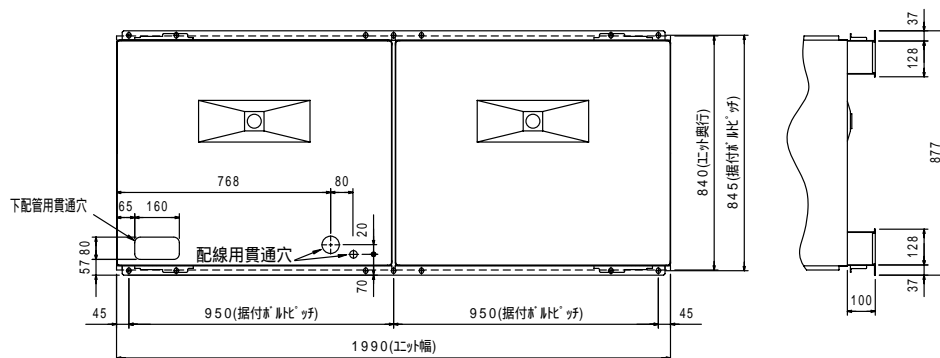

### (5)冷媒配管取出し方向

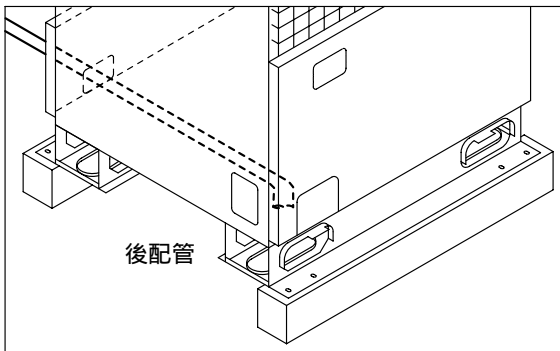

室外ユニットの冷媒配管取出し方向は、図のように  
下配管  
前配管  
左配管  
後配管(別売後配管キット必要。P140~P450のみ)  
の4とおりが可能です。

ただし、集中設置、連続設置時等、ユニット左側に他のユニットが連結された場合、そのユニットの左配管はできません。

下配管する場合は、本体の底下に配管が通るように高さ100mm以上の基礎を設けてください。

前配管、後配管でロックアウト穴を取外した場合は、雨水等が入らないように養生してください。

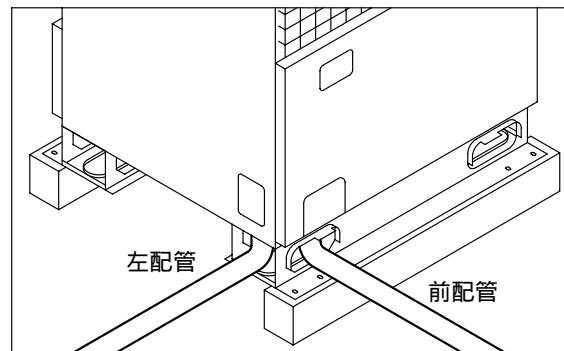
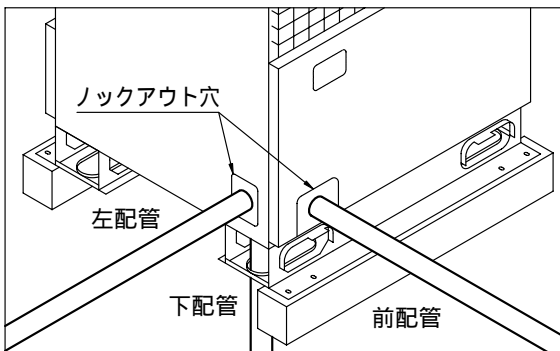

## 2.雪・季節風に対する注意

寒冷地域や積雪の予想される地域で、冬季にユニットを正常に運転するためには、十分な防風、防雪対策が必要です。その他の地域でも、季節風や降雪の影響による異常運転を防止するために、ユニットの設置に際して十分な配慮をお願いいたします。また、外気10以下で冷房運転を実施する場合、ユニットに直接風・雨・雪が当たる時は、ユニットの安定した運転を得るために、ユニットに吹出ダクト、吸込ダクトを取付けるようにしてください。

### (1) 寒冷地域・積雪地域での防風・防雪対策

下図に防雪フード組込図を示しますので参考にしてください。

#### 防雪フード組込図

PUHY-P140・P160・P224・P280・P335・P355・P400・P450M-E形

オプション部品	P140・P160・P224 P280・P335・P355・P400	P450
吹出ダクト	PAC-KJ71TD	PAC-KJ72TD
吸込ダクト	PAC-KJ81SD	PAC-KJ82SD
A 寸法	932	1232
B 寸法	990	1290

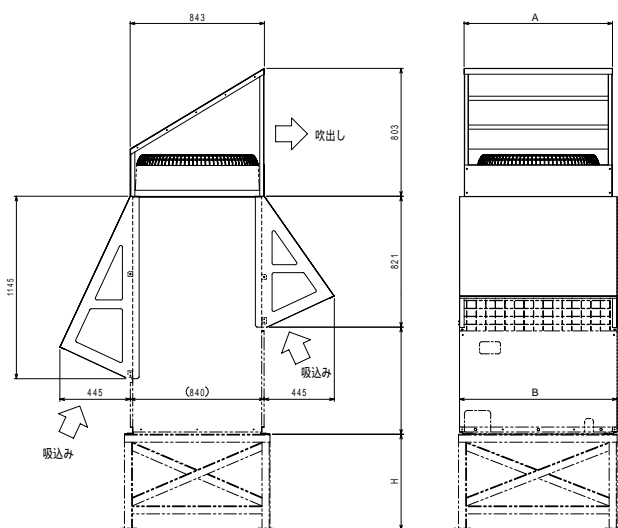

(注)

- (1) 防雪架台の高さ <H> は、予想される積雪量の2倍程度としてください。また、架台はアングル鋼材等で組立て、風雪の素通りする構造とし、架台の幅はユニットの寸法より大きくならないよう決定してください。大きくするとその上に積雪します。
- (2) 本図を参考として現地にて架台の製作、施工を実施してください。  
材質：亜鉛メッキ鋼板1.2T、1.6T  
塗装：ポリエステル粉体全面塗装  
色：マンセル5Y8/1(本体同色)
- (3) 寒冷地域での使用で、外気が氷点下以下の暖房運転を連続的に長期間使用するには、ユニットベースへのヒーター取付等を適宜行い、ベース上の氷結を防止するようにしてください。

PUHY-P500・P560・P630・P674・P730M-E形

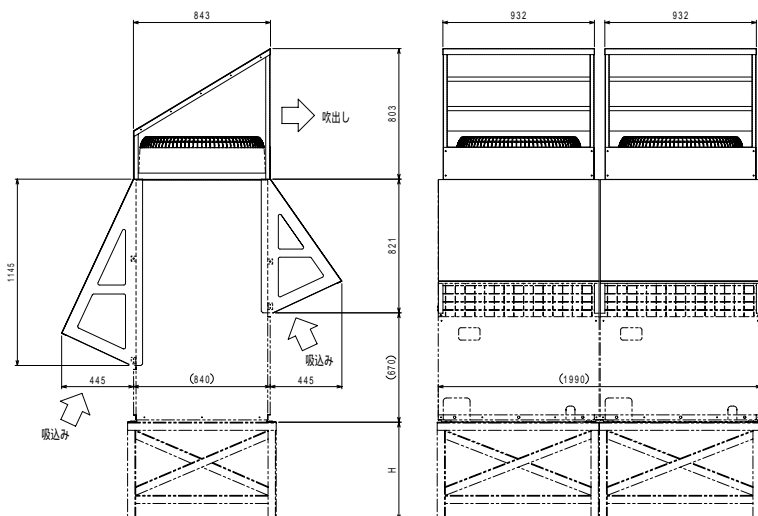

オプション部品	形名
吹出ダクト	PAC-KJ83TD
吸込ダクト	PAC-KJ83SD

PUHY-P684・P740・P800SM-E形

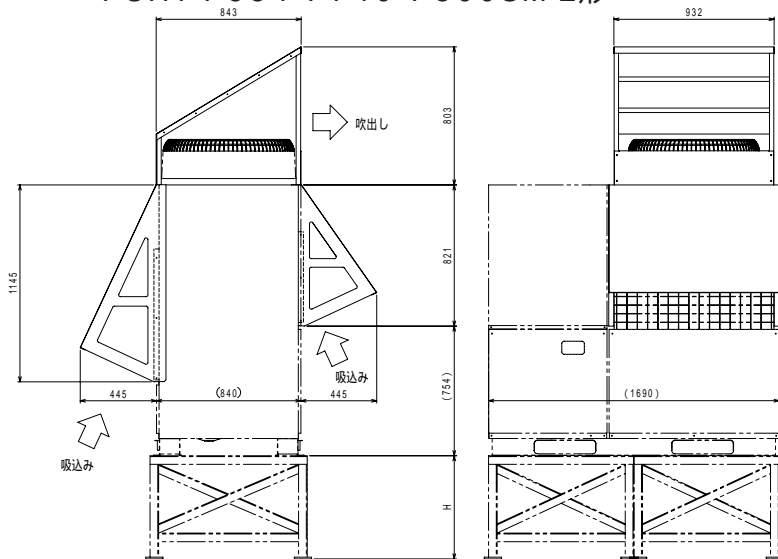

オプション部品	形名
吹出ダクト	PAC-KJ71TD
吸込ダクト	PAC-KL86SD

PVHN-P100SM-E形

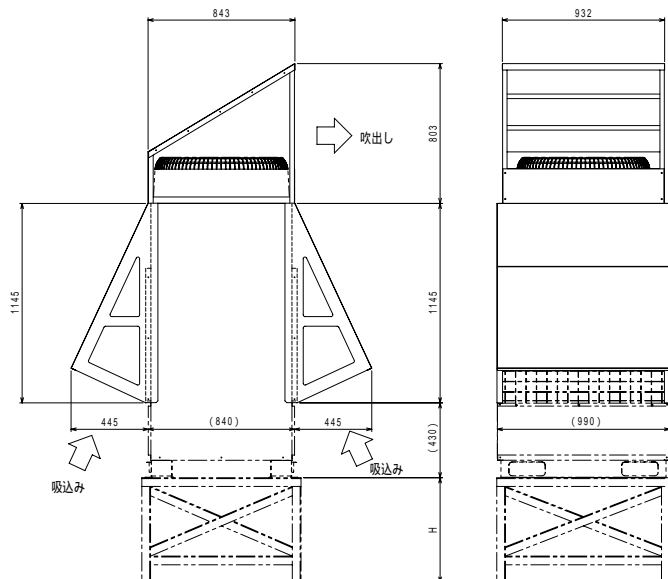

オプション部品	形名
吹出ダクト	PAC-KJ71TD
吸込ダクト	PAC-KL87SD

PUHY-P500・P560・P630・P670・P730SM-E形  
PUHY-P450・P730KM-E形

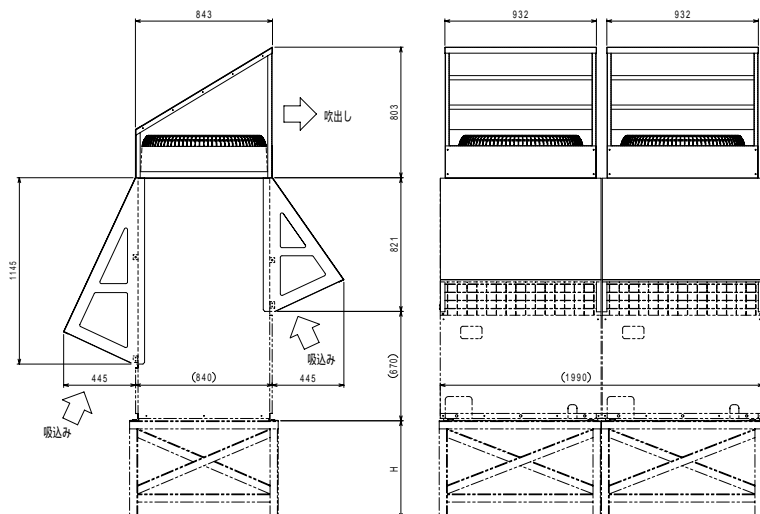

オプション部品	形名
吹出ダクト	PAC-KJ83TD
吸込ダクト	PAC-KJ83SD



### 3.冷媒配管工事

冷媒配管は下記材料をお使いください。

- ・材質：リン脱酸継目無銅管 JIS規格（H3300）品のC1220T-OLまたはC1220T-O（C1220T-OL）が望ましい。また、管の内外面は美麗であり、使用上有害なイオウ、酸化物、ゴミ、切粉、油脂、水分等（コンタミネーション）の付着がないことを確認してください。
- ・サイズ： -2「冷媒配管の選定」をご覧ください。

市販の銅管にはゴミが入っている場合がありますので、乾燥した不活性ガスにて吹飛ばしてください。

配管加工、または配管工事中に配管の中にゴミや水分を入れないでください。

曲げ箇所は、できるだけ少なくし、曲げ半径は、できるだけ大きくしてください。

分岐部には、必ず別売品の下記分岐管セットをご使用ください。分岐ジョイントCMY-Y302-Dを使用する場合は、支流側の室内ユニット接続合計容量は必ずP730以下としてください。

#### （1）注意事項

分岐セット形名						
ライン分岐				ヘッダー分岐		
下流ユニット形名 合計224以下	下流ユニット形名 合計225以上450以下	下流ユニット形名 合計451以上730以下	下流ユニット形名 合計731以上 P784-P1400S(K)M-Eのみ	4分岐 下流ユニット形名 合計224以下	8分岐 下流ユニット形名 合計450以下	10分岐 下流ユニット形名 合計730以下
CMY-Y102S-D	CMY-Y102L-D	CMY-Y202-D	CMY-Y302-D	CMY-Y104-D	CMY-Y108-D	CMY-Y1010-D

指定冷媒配管が分岐管の径と異なる場合、パイプカッターで接続部を切断するか、もしくは異径接手の径をあわせてから使用してください。

冷媒配管制限（許容長さ、高低差、配管径）は必ず守ってください。故障や冷暖房不良の原因となります。ヘッダー分岐後の再分岐はできません。（×印部分）

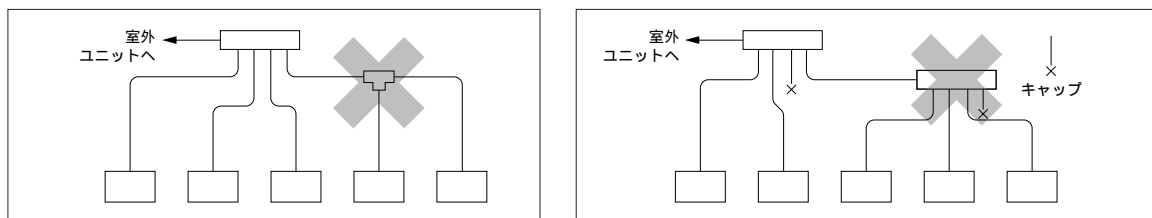

ロウ材は、JIS指定品の良質なものを使用してください。

シティマルチは、冷媒の過不足により異常停止しますので、正確に冷媒チャージを行ってください。また、サービス時のために必ず配管長と共に追加した冷媒量を、サービスパネル裏面の「ご注意ラベル冷媒量計算」の欄と、「組合せ室内ユニット記入ラベルの追加冷媒量」の欄に表示してください。

冷媒は、液冷媒にて封入してください。

冷媒によるエアパーズは絶対に行わないでください。必ず真空ポンプによる真空引きを行ってください。

配管の断熱を正しく行ってください。不十分な場合、冷暖房不良や露タレ等によってトラブルが発生することがあります。（-3(6)「冷媒配管の断熱」をご覧ください）

冷媒配管の接続は室外ユニットのボールバルブを全閉（工場出荷時仕様）のままとし、室内・室外ユニットと冷媒配管を全て接続して、冷媒漏れ試験、真空引き作業が終了するまで操作しないでください。

配管接続の際は、必ず無酸化ロウ付を行ってください。無酸化ロウ付を行わないと、圧縮機の破損につながるおそれがあります。必ず窒素置換による無酸化ロウ付をしてください。市販の酸化防止剤は配管腐食や冷凍機油の劣化の原因になることがあるので使用しないでください。詳細については、お問合わせください。

（配管接続およびバルブ操作の詳細は「配管接続」の項をご参照ください。）

雨天時に室外ユニットの配管接続作業はしないでください。

**⚠警告**

据付けや移設の場合は、機器に表示されている冷媒 (R410A) 以外の異なった冷媒を入れしないでください。

- 冷凍サイクルが異常となり、破裂等の原因になります。

**⚠注意**

冷媒配管はJIS H3300「銅及び銅合金継目無管」のC1220のリン脱酸銅を使用してください。また、管の内外面は美麗であり、使用上有害なイオウ、酸化物、ゴミ、切粉、油脂、水分等(コンタミネーション)の付着がないことを確認してください。

- 冷媒配管の内部にコンタミネーションの付着があると、冷凍機油劣化等の原因になります。

**⚠注意**

液冷媒にて封入してください。

- ガス冷媒で封入するとボンベ内冷媒の組成が変化し、能力不足等の原因になります。

**⚠注意**

既設の冷媒配管を流用しないでください。

- 既設の配管内部には、従来の冷凍機油や冷媒中の塩素が多量に含まれ、これらの物質が新しい機器の冷凍機油劣化等の原因になります。

**⚠注意**

据付けに使用する配管は屋内に保管し、両端ともロウ付する直前までシールしておいてください。  
(エルボ等の継手はビニール袋等に包んだ状態で保管)

- 冷媒回路内にほこり、ゴミ、水分が混入しますと、油の劣化・圧縮機故障の原因となります。

**⚠注意**

チャージングシリンダーを使用しないでください。

- チャージングシリンダーを使用すると冷媒の組成が変化し、能力不足等の原因になります。

**(2) 冷媒追加充てん量の算出方法**

冷媒は工場出荷時、室外ユニットに下表の値を封入していますが、延長配管分は含まれていませんので、現地にて追加充てんしてください。

また、サービス時のために各液管サイズの長さ、追加充てんした冷媒量を室外ユニットに記入してください。

室外ユニット形名	PUHY-P140,160M-E	PUHY-P224M-E	PUHY-P280,335M-E	PUHY-P355,400M-E	PUHY-P450M-E	PUHY-P500M-E	PUHY-P560M-E	PUHY-P630M-E	
冷媒封入量	7.0	7.0	9.5	9.5	13.0	16.0	16.0	22.0	
室外ユニット形名	PUHY-P674M-E	PUHY-P730M-E	PUHY-P784SM-E	PUHY-P840SM-E	PUHY-P900SM-E				
冷媒封入量	22.0	22.0	27.0	27.0	27.0				
室外ユニット形名	PUHY-P960SKM-E	PUHY-P1010SKM-E	PUHY-P1080SKM-E	PUHY-P1130SKM-E	PUHY-P1180SKM-E	PUHY-P1240SKM-E	PUHY-P1300SKM-E	PUHY-P1360SKM-E	PUHY-P1400SKM-E
冷媒封入量	44.0	44.0	44.0	44.0	44.0	44.0	44.0	44.0	44.0

追加充てん量は、延長配管の液管サイズとその長さで計算します。

液管サイズ 19.05の総長×0.29	+	液管サイズ 15.88の総長×0.20	+	液管サイズ 12.7の総長×0.12	+	液管サイズ 9.52の総長×0.06	+	液管サイズ 6.35の総長×0.024	+	接続室内ユニット 合計容量	室内ユニット分
(m) × 0.29(kg/m)		(m) × 0.20(kg/m)		(m) × 0.12(kg/m)		(m) × 0.06(kg/m)		(m) × 0.024(kg/m)		~ 90形	1.0kg
										91~180形	1.5kg
										181~370形	2.0kg
										371~540形	2.5kg
										541~710形	3.0kg
										711~800形	4.0kg
										801~1000形	5.0kg
										1001~1200形	6.0kg
										1201~1400形	7.0kg
										1401~形	9.0kg

下記要領で、冷媒追加充てん量を計算し、追加充てんしてください。

計算結果で、0.1kg未満の端数は、切上げてください。

例：12.73kgの場合 12.8kg になります。

P140~P400M-Eシリーズの場合、工場出荷時に室外ユニットに封入されている冷媒量と、延長配管分の追加充てん量を加えた全冷媒量が30kgを超える場合には、全冷媒量が30kgとなるシステムとしてください。

工場出荷時封入冷媒量 + 追加充てん量 30kg

計算例 (P280M-Eの場合)

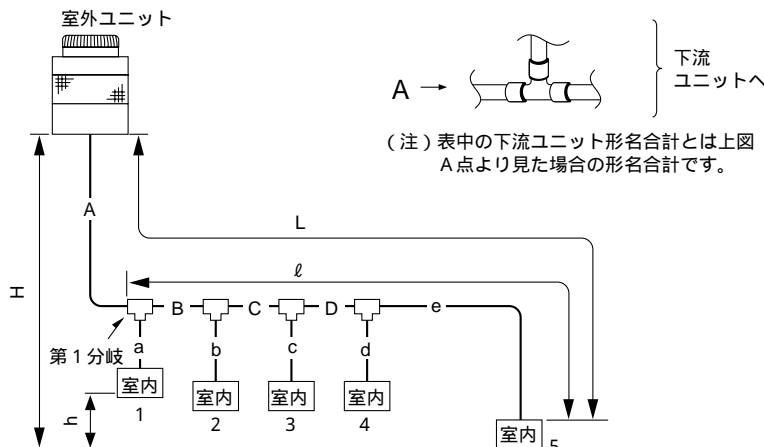

例 室内1:71形 A: 9.52 40m a: 9.52 10m  
 2:112形 B: 9.52 10m b: 9.52 10m  
 3:56形 C: 9.52 5m c: 6.35 10m  
 4:36形 D: 9.52 5m d: 6.35 5m  
 5:36形 e: 6.35 10m } の時

各液管総長は  
 $9.52:A + B + C + D + a + b = 40 + 10 + 5 + 5 + 10 + 10 = 80\text{m}$   
 $6.35:c + d + e = 10 + 5 + 10 = 25\text{m}$

したがって  
 計算例 追加充てん量 =  $80 \times 0.06 + 25 \times 0.024 + 2$   
 = 7.4kg

計算式

PUHY-P784 ~ P900SM-Eシリーズの場合、工場出荷時に室外ユニットに封入されている冷媒量と、延長配管分の追加充てん量を加えた全冷媒量が73kgを超える場合には、全冷媒量を73kgとしてください。  
 工場出荷時封入冷媒量 + 追加充てん量 73kg

計算例：室外ユニット PUHY-P840SM-E形

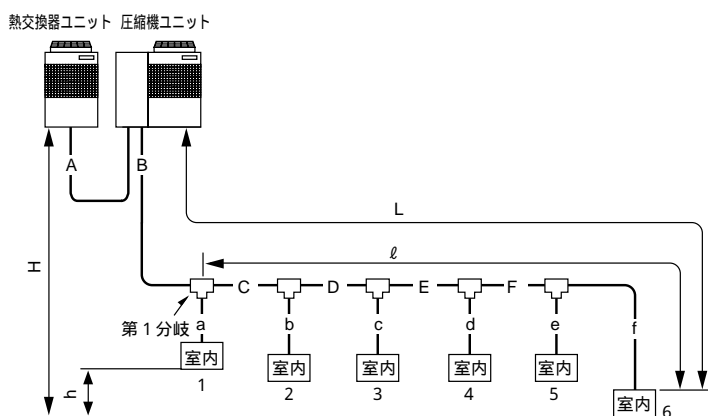

例 室内 1:280形 A: 12.7 3m a: 9.52 15m  
 2:224形 B: 19.05 40m b: 9.52 15m  
 3:140形 C: 15.88 10m c: 9.52 10m  
 4:71形 D: 9.52 5m d: 9.52 5m  
 5:56形 E: 9.52 5m e: 6.35 5m  
 6:28形 F: 9.52 5m f: 6.35 5m } の時

各液管総長は、  
 $19.05 : B = 40\text{m}$   
 $15.88 : C = 10\text{m}$   
 $12.7 : A = 3\text{m}$   
 $9.52 : D + E + F + G + C + a + b + d = 5 + 5 + 5 + 10 + 15 + 15 + 5 = 60\text{m}$   
 $6.35 : e + f = 5 + 5 = 10\text{m}$

したがって、  
 計算例 追加充てん量 =  $40 \times 0.29 + 10 \times 0.20 + 3 \times 0.12 + 60 \times 0.06 + 10 \times 0.024 + 4.0$   
 = 21.8kg

計算例：室外ユニット PUHY-P1130SKM-E形

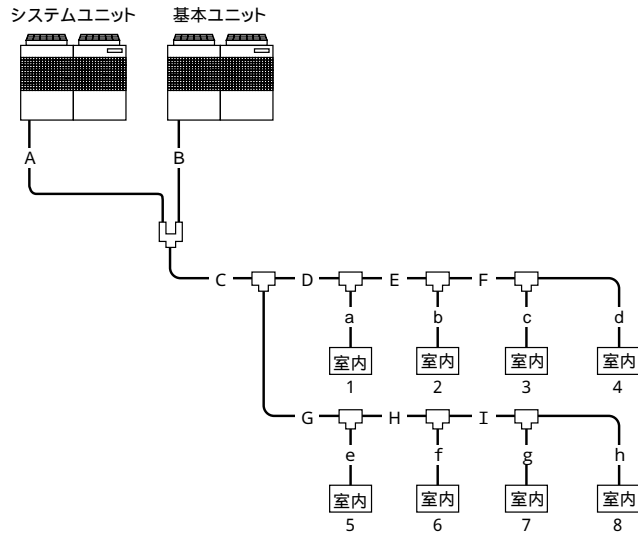

例	室内	1:280形	A: 15.88	3m	a: 9.52	15m	} の時
		2:224形	B: 15.88	1m	b: 9.52	15m	
		3:90形	C: 19.05	40m	c: 9.52	5m	
		4:80形	D: 15.88	10m	d: 9.52	5m	
		5:160形	E: 12.7	5m	e: 9.52	5m	
		6:140形	F: 9.52	5m	f: 9.52	5m	
		7:71形	G: 12.7	30m	g: 9.52	5m	
		8:28形	H: 9.52	5m	h: 6.35	5m	

各液管総長は、

- 19.05 : C = 40m
- 15.88 : A + B + D = 14m
- 12.7 : E + G = 35m
- 9.52 : F + H + I + a + b + c + d + e + f + g = 70m
- 6.35 : h = 5m

したがって、

計算例 追加充てん量 =  $40 \times 0.29 + 14 \times 0.20 + 35 \times 0.12 + 70 \times 0.06 + 5 \times 0.024 + 6.0$   
 = 29.0kg

### (3) 配管接続・バルブ操作のご注意 室外ユニット

- 配管接続、バルブ操作は下図にしたがって確実に行ってください。
- ガス側接続管（フランジタイプ）は組付けて出荷しています。（右図参照）  
フランジ付接続管へのロウ付の際には、フランジ付接続管をボールバルブから取外し、ユニットの外部にてロウ付してください。  
フランジ付き接続管を取外している間、ボールバルブ内へのゴミの侵入を防止するため、チュウイフダの裏面に貼付けているシールを剥がして、ボールバルブのフランジ面に貼付けてください。  
出荷時には、フランジ間にガス漏れ防止のため中実のパッキンを入れて冷媒回路を遮断しています。  
このままの状態では運転できませんので、配管接続に際しては必ず付属の中空パッキンと交換してください。  
中空パッキン取付けに際しては、フランジのシート面、およびパッキンにゴミ等の付着がないように拭取ってください。パッキンの両面には冷凍機油(エステル油又はエーテル油又はアルキルベンゼン [少量]) を塗布してください。
- 真空引き、冷媒チャージ後は必ず、ハンドルを全開状態にしてください。バルブを閉めたまま運転しますと冷媒回路高圧側または低圧側が異常圧力となり、圧縮機、四方弁等の損傷を招きます。
- 計算式により、追加冷媒量を決定し、配管接続作業完了後にサービスポートから追加チャージを行ってください。
- 作業完了後、サービスポートおよびキャップはガス漏れの起らないようしっかり締付けてください。

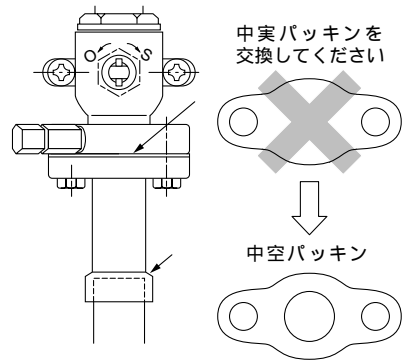

<PUHY-P140・P160・P224・P280・P335・P355・P400・P450・P500・P560・P630・P674・P730M-E形>

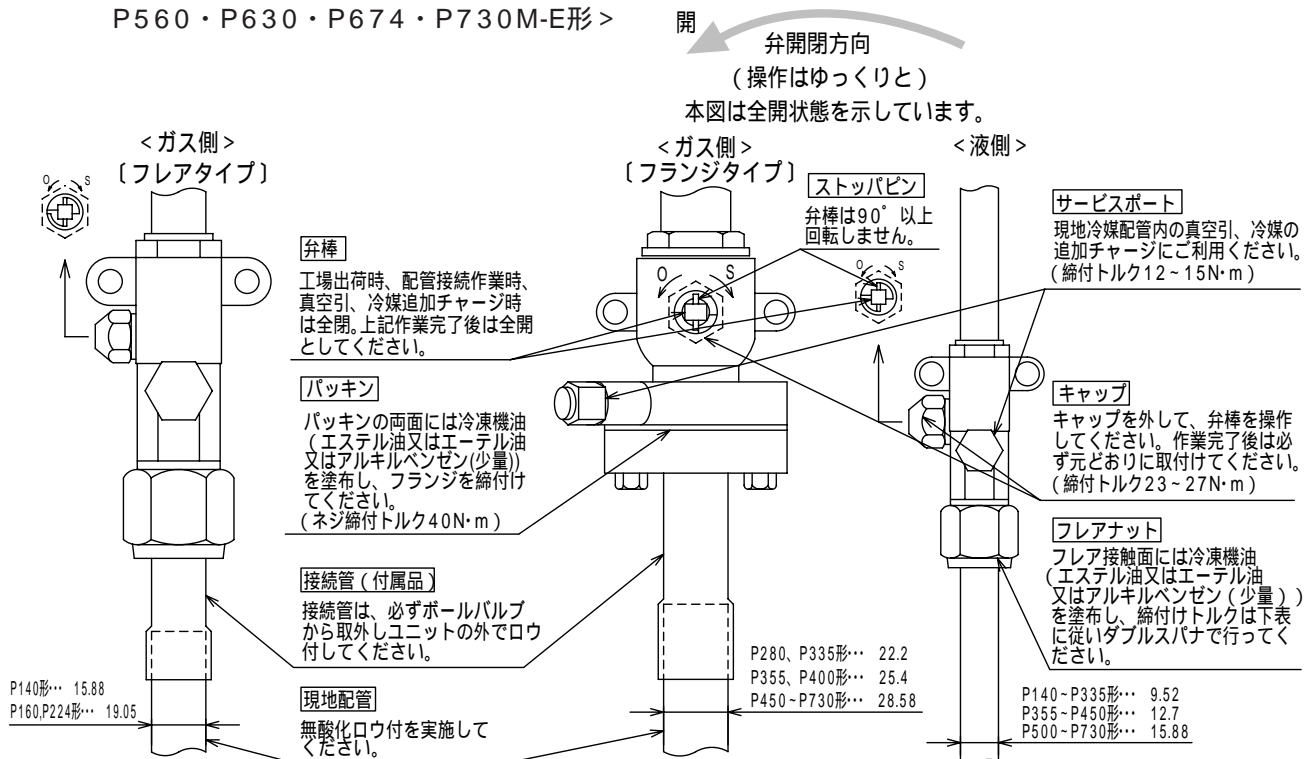

#### ⚠注意

接続管は必ずボールバルブから取外し、ユニットの外でロウ付してください。

- 取付けたままロウ付すると、ボールバルブが加熱されて故障やガス漏れの原因となります。またユニット内の配線等を焼くおそれもあります。

#### ⚠注意

フレア・フランジ接続部に塗布する冷凍機油は、エステル油又はエーテル油又はアルキルベンゼン（少量）を使用してください。

- 鉱油が多量に混入すると、冷凍機油劣化の原因となります。

P280、P335形において、配管長が長く、12.7にサイズアップする時は、9.52で接続後、12.7に接続してください。  
(9.52の長さ1m以下)

トルクレンチによる適正な締付力

銅管外径(mm)	締付力(N・m)
6.35	14～18
9.52	35～42
12.7	50～57.5
15.88	75～80
19.05	100～140

締付角度の目安

パイプ径	締付角度
6.35 9.52	60°～90°
12.7 15.88	30°～60°
19.05	20°～35°

トルクレンチが無い場合、次の方法を目安にします。  
フレアナットをスパナで締付けて行くと締付トルクが急に増すときがありますのでそこで一度とめてそれから更に上表の角度だけ回転させます。

< PUHY-P784・P840・P900SM-E形 >

< 圧縮機ユニット (PUHY-P684・P740・P800SM-E形) の場合 >

● 配管接続、バルブ操作は下図に従って確実に行ってください。

< 熱交換器ユニット (PVHN-P100SM-E形) の場合 >

● ロウ付接続を行ってください。

● 真空引き、冷媒チャージ後は必ずハンドルを全開状態にしてください。バルブを閉めたまま運転しますと、冷媒回路 高压側または低压側が異常圧力となり、また、ユニット間の油移動がなく圧縮機内の油が不足になるなど、圧縮機、 四方弁等の損傷を招きます。

● 真空引きは、圧縮機ユニットと熱交換器ユニット間の接続配管も必ず実施してください。

● 計算式により、追加冷媒量を決定し、配管接続作業完了後にサービスポートから追加チャージを行ってください。

● 作業完了後、サービスポートおよびキャップはガス漏れの起らないようしっかり締付けてください。

● ボールバルブの全開作業は、配管接続 真空引き 冷媒追加が終わった後に必ず実施してください。

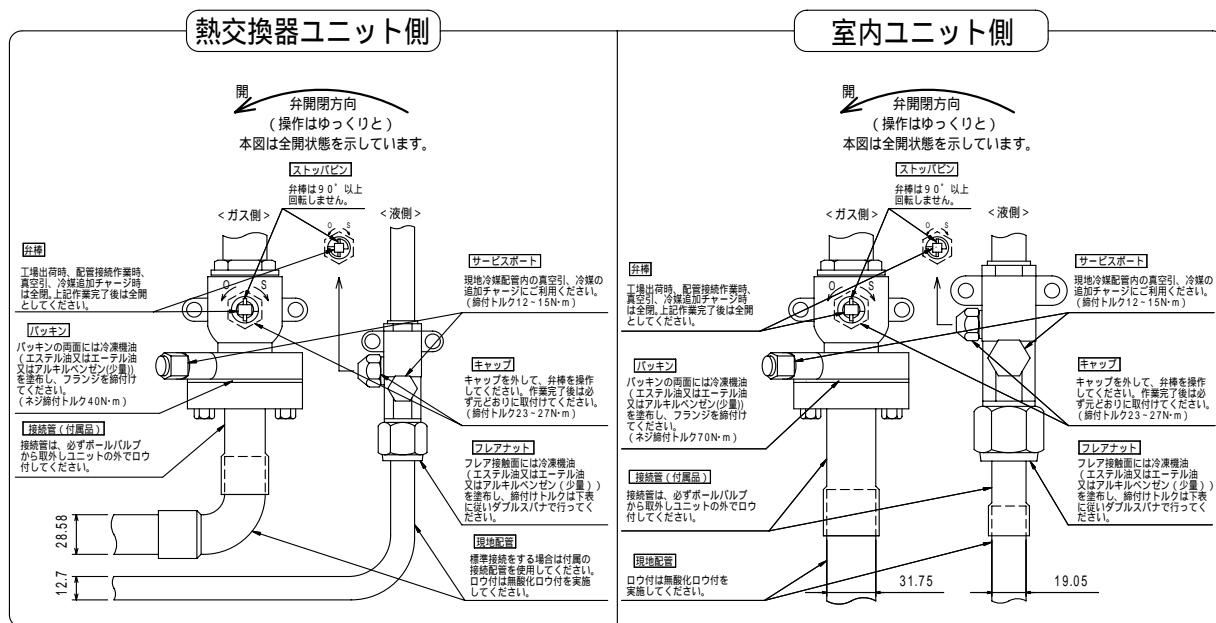

### 警告

接続管は、必ずボールバルブから取外し、ユニットの外でロウ付してください。

- 取付けたままロウ付すると、ボールバルブが加熱されて破裂やガス漏れの原因となります。またユニット内の配線等を焼くおそれもあります。

### 警告

現地配管への冷媒チャージが完了するまでボールバルブを開けないようにしてください。

- チャージ前にバルブを開けると、ユニット損傷の原因になります。

### 注意

フレア・フランジ接続部に塗布する冷凍機油は、エステル油又はエーテル油又はアルキルベンゼン（少量）を使用してください。

- 鉱油が多量に混入すると、冷凍機油劣化の原因となります。

### トルクレンチによる適正な締付力

鋼管外径(mm)	締付力(N・m)
6.35	14～18
9.52	35～42
12.7	50～57.5
15.88	75～80
19.05	100～140

### 締付角度の目安

パイプ径	締付角度
6.35 9.52	60°～90°
12.7 15.88	30°～60°
19.05	20°～35°

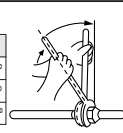

トルクレンチが無い場合、次の方法を目安にします。フレアナットをスパナで締付けて行くと締付トルクが急に増すときがありますのでそこで一度とめてそれから更に上表の角度だけ回転させます。

<PUHY-P960・P1010・P1080・P1130・P1180・P1240・P1300・P1360・P1400SKM-E形>

<システムユニット (PUHY-P500・P560・P630・P670・P730SM-E形)

基本ユニット (PUHY-P450・P730KM-E形) の場合>

- 配管接続、バルブ操作は下図に従って確実に行ってください。
- 真空引き、冷媒チャージ後は必ず液側・ガス側ボールバルブのハンドルと均油用バルブのシャフトを全開状態にしてください。バルブを閉めたまま運転しますと、冷媒回路高压側または低压側が異常圧力となり、また、ユニット間の油移動がなく圧縮機内の油が不足になるなど、圧縮機、四方弁等の損傷を招きます。
- 真空引きは、システムユニットと基本ユニット間の接続配管および均油管も必ず実施してください。
- 計算式により、追加冷媒量を決定し、配管接続作業完了後にサービスポートから追加チャージを行ってください。
- 作業完了後、サービスポートおよびキャップはガス漏れの起らないようしっかり締付けてください。
- ボールバルブの全開作業は、配管接続 真空引き 冷媒追加が終わった後に必ず実施してください。

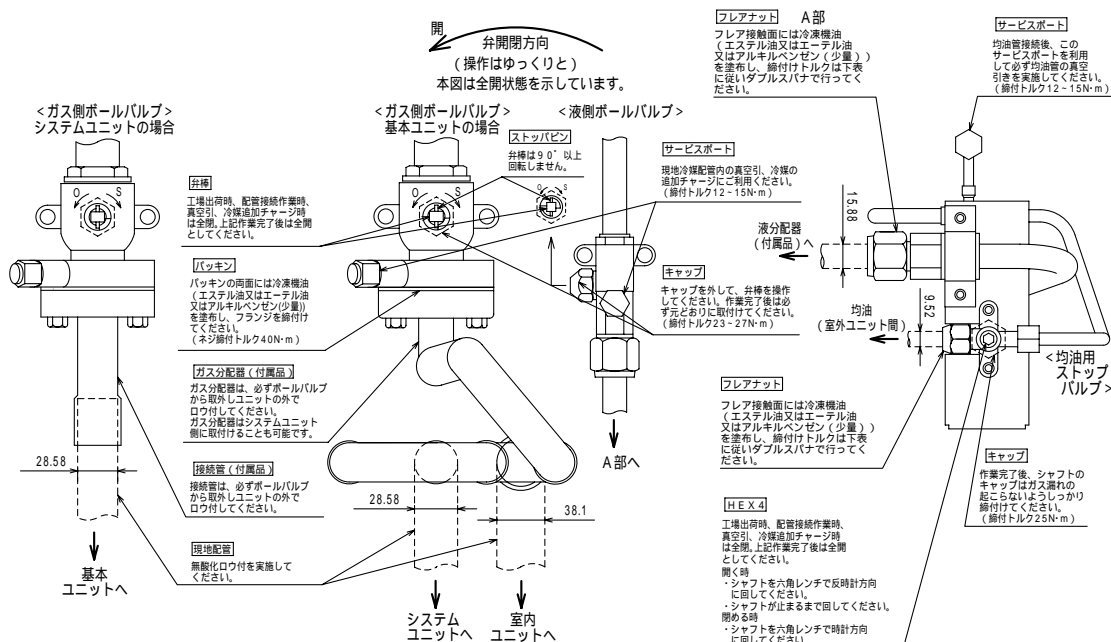

### 警告

接続管、ガス分配器は、必ずボールバルブから取外し、ユニットの外でロウ付してください。

- 取付けたままロウ付すると、ボールバルブが加熱されて破裂やガス漏れの原因となります。またユニット内の配線等を焼くおそれもあります。

### 警告

現地配管への冷媒チャージが完了するまでボールバルブを開けないようにしてください。

- チャージ前にバルブを開けると、ユニット損傷の原因になります。

### 注意

フレア・フランジ接続部に塗布する冷凍機油は、エステル油又はエーテル油又はアルキルベンゼン(少量)を使用してください。

- 鉱油が多量に混入すると、冷凍機油劣化の原因となります。

### トルクレンチによる適正な締付力

銅管外径(mm)	締付力(N・m)
6.35	14 ~ 18
9.52	35 ~ 42
12.7	50 ~ 57.5
15.88	75 ~ 80
19.05	100 ~ 140

### 締付角度の目安

パイプ径	締付角度
6.35 9.52	60°~90°
12.7 15.88	30°~60°
19.05	20°~35°

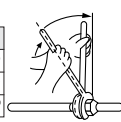

トルクレンチが無い場合、次の方法を目安にします。フレアナットをスパナで締付けて行くと締付トルクが急に増すときがありますのでそこで一度とめてそれから更の上表の角度だけ回転させます。

## 配管接続例 ( P960 ~ P1400SKM-Eの場合 )

下図を参考にシステムユニット - 基本ユニット間の配管接続を行ってください。

- ・ガス側接続管、ガス分配器は組付けて出荷しています。  
ガス側接続管、ガス分配器へのロウ付の際には、必ずそれぞれをボールバルブから取外しユニットの外部にてロウ付してください。
  - ・ボールバルブへの配管接続は、ガス側から行ってください。
  - ・ガス側接続管、ガス分配器を取外している間、ボールバルブ内へのゴミの侵入を防止するためチュウイフダの裏面に貼付けているシールをはがして、ボールバルブのフランジ面に貼付けてください。
  - ・出荷時には、フランジ間にガス漏れ防止のため中実のパッキンを入れて冷媒回路を遮断しています。このままの状態では運転できませんので、配管接続に際しては必ず付属の中空パッキンと交換してください。
  - ・中空パッキン取付けに際しては、フランジのシート面、またはパッキンにゴミなどの付着がないように拭取ってください。
- パッキンの両面には冷凍機油（エステル油、エーテル油、または少量のアルキルベンゼン）を塗布してください。
- ・ガス分配器はシステムユニット側にも取付け可能です。

### < 前面配管取出しの場合 >

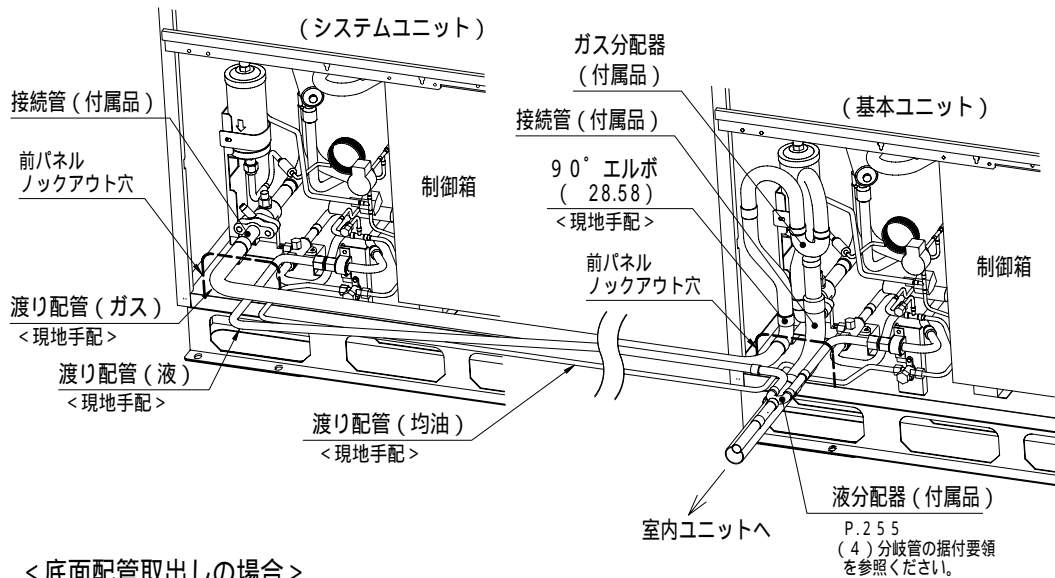

### < 底面配管取出しの場合 >

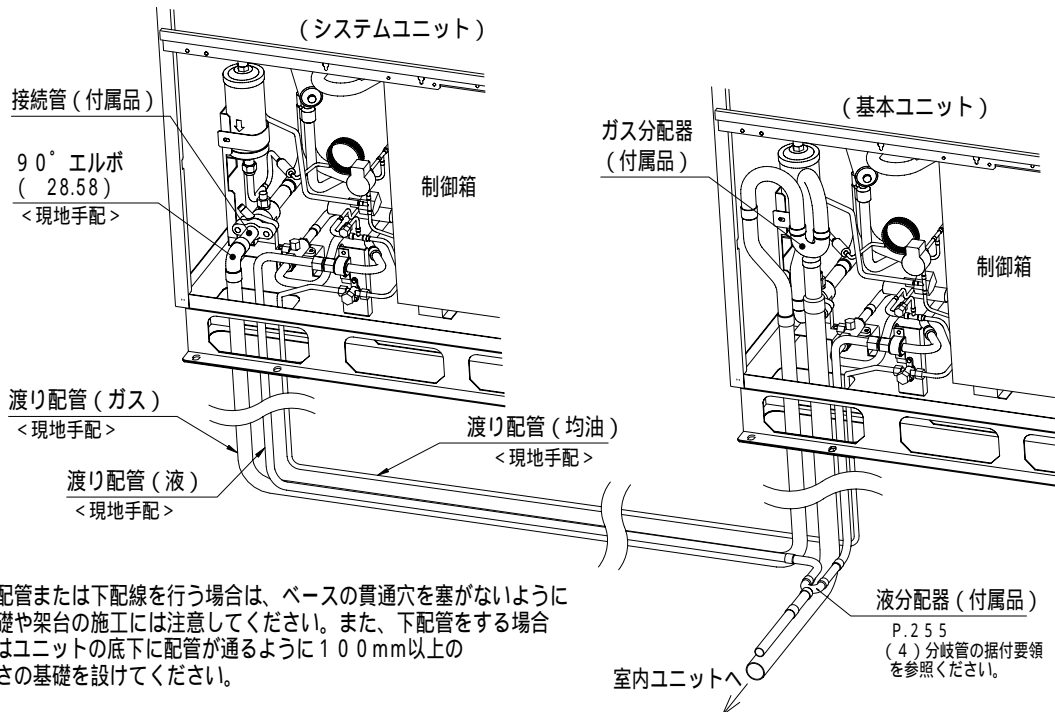

下配管または下配線を行う場合は、ベースの貫通穴を塞がないように基礎や架台の施工には注意してください。また、下配管をする場合にはユニットの底下に配管が通るように100mm以上の高さの基礎を設けてください。



#### (4) 分岐管の据付要領

詳細については、別売冷媒分岐キットに付属の説明書によって行ってください。

##### ジョイント

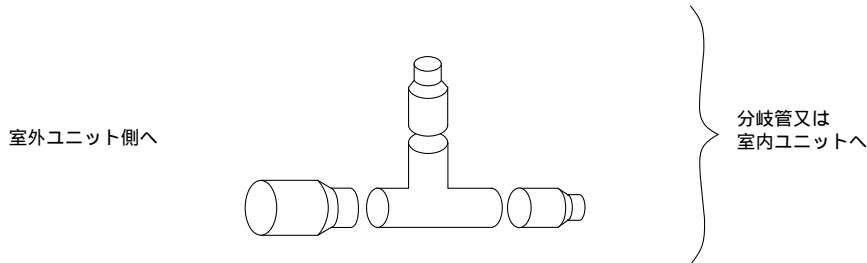

- ・ジョイントの取付姿勢についての制約は、CMY-Y202-D、CMY-Y302-Dのガス側だけです。
- ・CMY-Y202-D、CMY-Y302-Dのガス側分岐管は、水平又は垂直上向き(右図)となるように取付けてください。
- ・-2項「冷媒配管の選定」により選定した冷媒配管とジョイントのサイズが異なる場合、異径接手を使用し、サイズをあわせて使用してください。異径接手は、キットに付属されています。

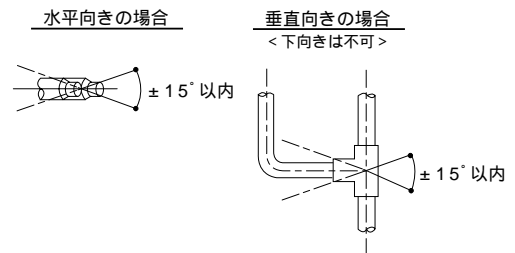

##### ヘッダー

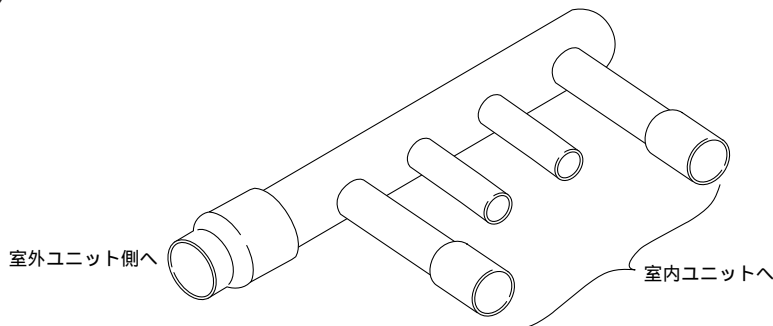

- ・ヘッダーの取付姿勢についての制約はありません。
- ・-2項「冷媒配管の選定」により選定した冷媒配管とヘッダーのサイズが異なる場合、接続部をパイプカッター等で切断するか、又は異径接手を使用し、サイズをあわせて使用してください。

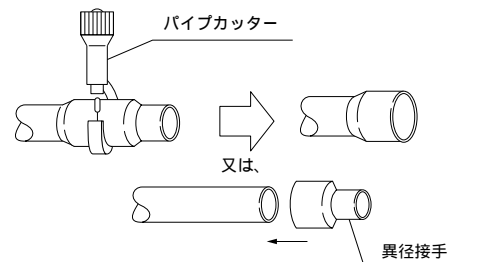

- ・接続する配管の数がヘッダーの分岐数より少ない場合は、接続しない箇所にキャップを取付けてください。キャップは、キットに付属されています。

##### 液分岐管 (P960 ~ P1400SKM-Eの場合)

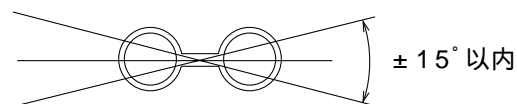

- ・システムユニットと基本ユニットの液管を合流させる液分岐管は、水平面に対し±15°以内(上図)となるように取付けてください。

## (5) 気密試験・真空引き・冷媒充てん

気密試験と真空引きについては、配管接続完了後に実施してください。

### 気密試験

気密試験は下図のように、室外ユニットのボールバルブを閉じたまま、室外ユニットのボールバルブについているサービスポートから接続配管と室内ユニットに加圧して行います。(必ず、液管・ガス管の両方のサービスポートより加圧してください。)

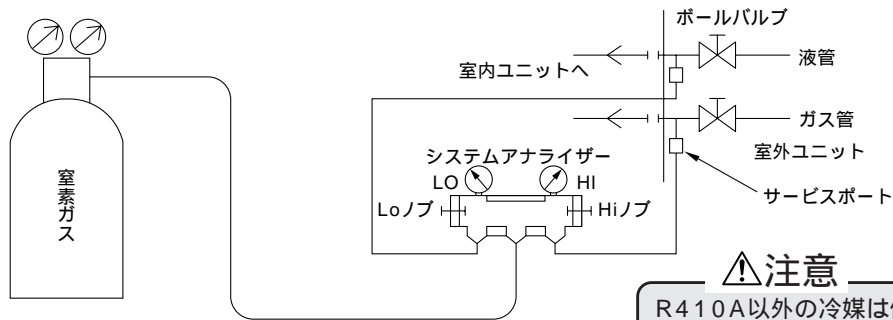

### ⚠注意

R410A以外の冷媒は使用しないでください。

- R410A以外 (R22, R407C等) を使用すると、塩素により冷凍機油劣化や圧縮機故障の原因になります。

気密試験のやり方は従来機と基本的に同じですが、冷凍機油劣化への影響が大きいため下記の制約事項を必ず遵守してください。

気密試験の手順	制約事項
<p><b>1. 窒素ガス加圧の場合</b></p> <p>(1) 窒素ガスにて設計圧力(4.15 MPa)に加圧後、1日程度放置し、圧力が低下していなければ良好です。但し、圧力が低下している場合、漏れ箇所は不明なので次の泡式で行うことができます。</p> <p>(2) 上記加圧後、フレア接続部・ロウ付部・フランジ部等漏れが予想されるすべての箇所に泡剤(キュボフレックスなど)をスプレーし、泡の発生を目視確認ください。</p> <p>(3) 気密試験後、泡剤をよく拭きとってください。</p>	<p>× 加圧ガスに可燃ガスや空気(酸素)を使用すると爆発の危険があります。</p>
<p><b>2. 冷媒ガスと窒素ガスで加圧の場合</b></p> <p>(1) <u>ポンベ</u>より R410Aを液で封入し、ガス圧力で約0.2MPa程度に加圧後、窒素ガスにて設計圧力(4.15 MPa)に加圧する。但し、一気に加圧しないで、途中加圧を停止し、圧力低下のないことを確認ください。</p> <p>(2) R410A対応の電気式リークディテクタでフレア接続部・ロウ付部・フランジ部等漏れが予想されるすべての箇所のガス漏洩を検査する。</p> <p>(3) 泡式のガス漏洩検査と併用しても良い。</p>	<p>× 機器に表示されている冷媒以外は、使用不可です。</p> <p>× <u>ポンベ</u>よりガスで封入するとポンベ内冷媒の組成が変化します。</p> <p>× 圧力計・チャージングホース等の部品は R410A専用のもを使用してください。</p> <p>× R22用電気式リークディテクタでは、漏洩検知できません。</p> <p>× 炎色式(ハライドトーチ)は使用不可です。(検出不可能)</p>

## 真空引き

真空引きは、下図のように、室外ユニットのボールバルブを閉じたまま、室外ユニットのボールバルブについているサービスポートから接続配管と室内ユニット共真空ポンプにて実施してください。(必ず、液管・ガス管の両方のサービスポートから行ってください。)

真空度が650Paに到達後、1時間以上真空引きをしてください。その後、真空ポンプを止めて1時間放置し、真空度が上昇していないことを確認してください。(真空度の上昇幅が130Paより大きい場合は、水分が混入している可能性がありますので、乾燥窒素ガスを0.05MPaまで加圧して、再度真空引きを実施してください。)最後に、液管から液冷媒にて封入してください。また、運転時に冷媒が適量になるようガス管から冷媒量調整をしてください。

冷媒によるエアパージは、絶対に行わないでください。

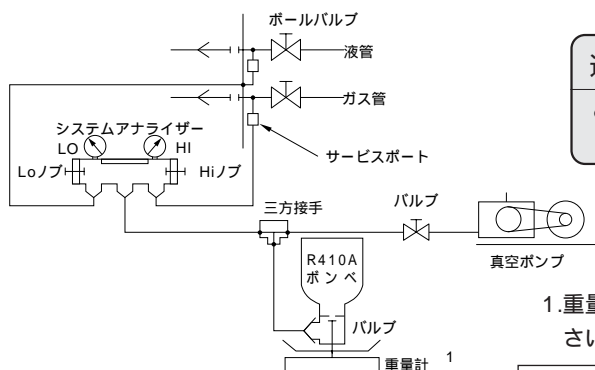

### ⚠注意

逆流防止器付真空ポンプを使用してください。

- 冷媒回路内に真空ポンプ油が逆流し、機器の冷凍油劣化等の原因になります。

1.重量計は精度の高いもの(0.1kgまで測定可能なもの)を使用してください。

2.真空ポンプは逆流防止器付のものを使用してください。  
(推奨真空度計 ROBINAIR 14010 Thermistor Vacuum Gauge.)  
また、真空ポンプは、5分運転後で65Pa[abs]以下のものを使用してください。

(注)・冷媒は必ず適量を追加してください。(冷媒追加量については248ページをご覧ください。)また、必ず液冷媒にて封入してください。

冷媒は多くても少なくともトラブルの原因になります。

- ・ゲージマニホールド、チャージングホース等の部品は機器に表示されている冷媒専用のものを使用してください。

## 冷媒充てん

機器に使用しています冷媒は、非共沸混合冷媒のため充てんに関しては液の状態で行う必要があります。よって、ポンベより機器に冷媒充てんするときに、サイフォン管が付いていないポンベの場合は下図のようにポンベを逆さにして充てんします。なお、右下図のようなサイフォン管付きポンベの場合は、立てたまま液冷媒を充てんすることができますので、ポンベの仕様には注意してください。

万一、ガスの状態で冷媒充てんした場合、機器は新しい冷媒に入換え、冷媒の残ったポンベは使用しないでください。

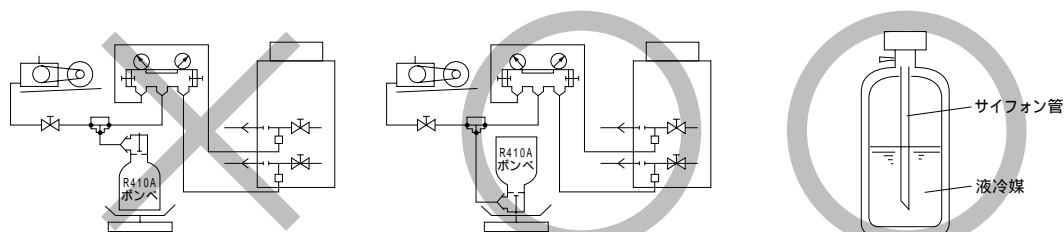

【サイフォン管が付いていないポンベの場合】

【サイフォン管付きポンベの場合(立てたまま液冷媒を充てんできる)】

### ⚠警告

据付けや移設の場合は、機器に表示されている冷媒(R410A)以外の異なった冷媒を入れないでください。

- 異なった冷媒や空気等が混入すると、冷凍サイクルが異常となり、破裂等の原因になります。

### ⚠注意

チャージングシリンダーを使用しないでください。

- チャージングシリンダーを使用すると冷媒の組成が変化し、能力不足等の原因になります。

### ⚠注意

工具類の管理は従来以上に注意してください。

- 冷媒回路内にほこり、ゴミ、水分等が混入しますと、冷凍機油劣化の原因になります。

### ⚠注意

従来の冷媒に使用している下記に示す工具類は使用しないでください。R410A専用の工具類を使用してください。

(ゲージマニホールド・チャージホース・ガス漏れ検知器・逆流防止器・冷媒チャージ用口金・冷媒回収装置)

- 従来の冷媒・冷凍機油が混入しますと冷凍機油劣化の原因になります。
- 水分が混入しますと、冷凍機油劣化の原因になります。
- 冷媒中に塩素を含まないため、従来の冷媒用ガス漏れ検知器では反応しません。

### 既設配管対応

本ユニットは、既設配管を流用することはできません。

既設の配管内部には、従来の冷凍機油や冷媒中の塩素が多量に含まれ、これらの物質が新しい機器の冷凍機油劣化等の原因になります。

冷媒R410Aは高圧冷媒です。配管の破裂等の原因になります。

(6)冷媒配管の断熱

冷媒配管の断熱は、必ず液管とガス管とを別々に十分な厚さの耐熱ポリエチレンフォームで、室内ユニットと断熱材および断熱材間の継目に隙間のない様に行ってください。

断熱工事が不完全だと露タレ等が発生することがありますので、特に天井裏内の断熱工事は注意が必要です。

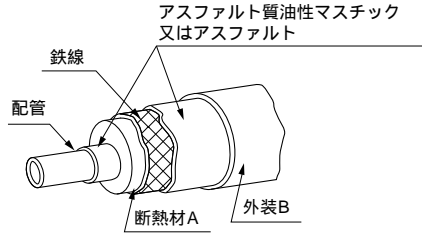

断熱材 A	グラスファイバー + 鉄線	
	接着剤 + 耐熱ポリエチレンフォーム + 圧着テープ	
外装 B	屋 内	ビニールテープ
	床下露出	防水麻布 + ブロンズアスファルト
	屋 外	防水麻布 + アエン鉄板 + 油性ペイント

(注) 被覆材にポリエチレンカバーを使用する場合は、アスファルトルーフィングは不要です。

悪い例	<p>●ガス管と液管を同時に断熱してはならない。</p> <p>✗</p>	<p>●接続部も十分断熱すること。</p> <p>✗</p>
良い例	<p>○</p>	<p>○</p>

(注) 電線の断熱処理は、行わないでください。

貫通部

○内壁 (いんぺい)

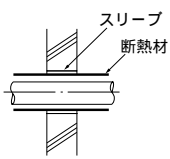

○外壁

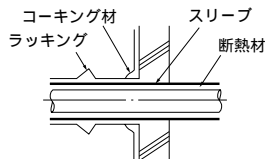

○外壁 (露出)

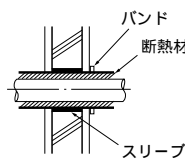

○防火区画、界壁等における貫通部

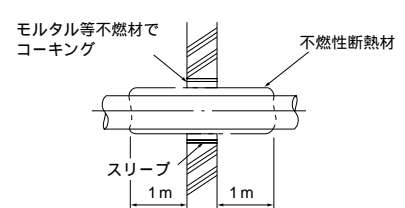

○床 (防水)

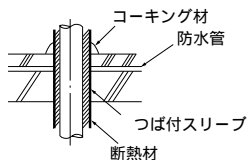

○屋上パイプシャフト

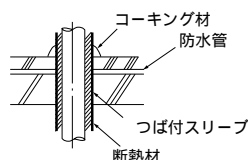

モルタルにてすき間を充てんする場合は、貫通部を鋼板にて被覆し断熱材がへこまないようにしてください。またその部分は不燃性断熱材を使用し、被覆材も不燃性(ビニールテープ巻きはダメ)を使用してください。

●現地配管の断熱材は、下表の規格を満足していることを確認してください。

	配管サイズ	
	6.35 ~ 25.4mm	28.58 ~ 38.1mm
厚さ	10mm以上	15mm以上
耐熱温度	100℃以上	

最上階など高温多湿の条件下で使用する場合は、左表以上の厚さが必要となる場合があります。客先指定の仕様がある場合は、左表の規格を満足する範囲でそれに従ってください。

## 4.電気工事

### (1) 配線設計にあたって

「電気設備に関する技術基準」・「内線規程」および、事前に各電力会社のご指導に従ってください。  
 ユニットの外部では、伝送線用配線が電源配線の電気ノイズを受けないよう離して施設してください。  
 (同一電線管に入れないでください。)

室外ユニットには、D種接地工事を必ず実施してください。

室内ユニット・室外ユニットの電気品箱は、サービス時取外すことがありますので、配線は必ず取外すための余裕を設けてください。

伝送線用端子台には、200V電源を絶対に接続しないでください。万一接続すると電子部品が焼損します。

伝送線用配線は、2心線をご使用ください。系統の異なる伝送線用配線を多心の同一ケーブルを使用して配線しますと、伝送信号の送・受信が正常にできなくなり、誤動作の原因になりますので絶対に行わないでください。(下図×印)

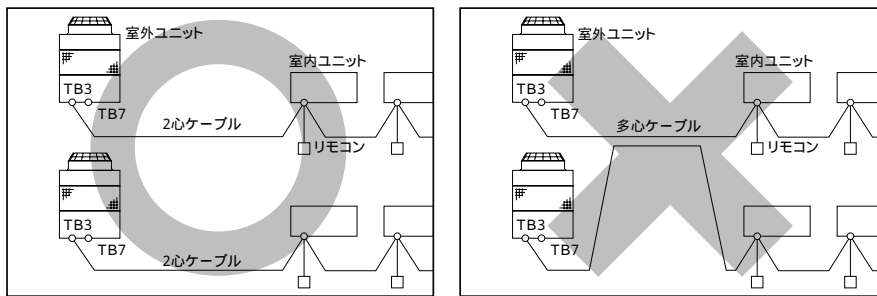

TB3：伝送線用端子台、TB7：集中管理用端子台

### (2) 主電源の配線太さおよび開閉器容量

#### 室外ユニット

#### < P140 ~ P730形 >

形名	最小電線太さ(mm <sup>2</sup> )			開閉器(A) <sup>1</sup>		配線用遮断器 NFB (A) <sup>2</sup>	漏電遮断器
	幹線	アース		容量	ヒューズ		
		1の場合	2の場合				
PUHY-P140M-E	5.5	2.0	2.0	30	30	30	30A 100mA 0.1s以下
PUHY-P160M-E	5.5	2.0	2.0	30	30	30	30A 100mA 0.1s以下
PUHY-P224M-E	8	3.5	3.5	60	40	40	40A 100mA 0.1s以下
PUHY-P280M-E	14	3.5	3.5	60	50	50	50A 100mA 0.1s以下
PUHY-P335M-E	14	5.5	5.5	60	50	60	60A 100mA 0.1s以下
PUHY-P355M-E	14	5.5	5.5	60	60	60	60A 100mA 0.1s以下
PUHY-P400M-E	22	5.5	5.5	60	60	60	60A 100mA 0.1s以下
PUHY-P450M-E	22	5.5	5.5	75	75	75	75A 100mA 0.1s以下
PUHY-P500M-E	38	5.5	5.5	75	75	75	75A 100mA 0.1s以下
PUHY-P560M-E	38	5.5	5.5	75	75	75	75A 100mA 0.1s以下
PUHY-P630M-E	38	5.5	5.5	100	100	100	100A 100mA 0.1s以下
PUHY-P674M-E	60	5.5	5.5	100	100	100	100A 100mA 0.1s以下
PUHY-P730M-E	60	5.5	5.5	100	100	100	100A 100mA 0.1s以下

#### < P784 ~ P900形 > (渡り配線接続の場合)

形名	最小電線太さ(mm <sup>2</sup> )				開閉器(A)		配線用遮断器 NFB	漏電遮断器
	熱交換器 ユニット	圧縮機 ユニット	アース		容量	ヒューズ		
			熱交換器 ユニット	圧縮機 ユニット				
PUHY-P784SM-E	1.6mm	60	1.6mm	14	200	125	125	125A 100mA 0.1s以下
PUHY-P840SM-E	1.6mm	60	1.6mm	14	200	125	125	125A 100mA 0.1s以下
PUHY-P900SM-E	1.6mm	60	1.6mm	14	200	150	150	150A 100mA 0.1s以下

< P784 ~ P900形 > (個別配線接続の場合)

形名		最小電線太さ(mm <sup>2</sup> )			開閉器(A) <sup>1</sup>		配線用遮断器 (NFB) <sup>2</sup>	漏電遮断器
		幹線	アース		容量	ヒューズ		
			1の場合	2の場合				
PUHY-P784SM-E	熱交換器ユニット	1.6mm	1.6mm	1.6mm	15	15	15	15A 30mA 0.1s以下
	圧縮機ユニット	60	5.5	5.5	100	100	100	100A 100mA 0.1s以下
PUHY-P840SM-E	熱交換器ユニット	1.6mm	1.6mm	1.6mm	15	15	15	15A 30mA 0.1s以下
	圧縮機ユニット	60	8	8	200	125	125	125A 100mA 0.1s以下
PUHY-P900SM-E	熱交換器ユニット	1.6mm	1.6mm	1.6mm	15	15	15	15A 30mA 0.1s以下
	圧縮機ユニット	60	8	8	200	125	125	125A 100mA 0.1s以下

(注) 表中、 1は、開閉器の場合、 2は、配線用遮断器の場合のアース線太さを示します。

< P960 ~ P1400形 > (個別配線接続の場合)

セット形名		漏電遮断器	手元開閉器		配線用遮断器 (NFB)<A>	電源配線太さ	接地線太さ
			開閉器容量<A>	過電流保護器<A>			
PUHY-P960SKM-E	システムユニット	75A 100mA 0.1s以下	75	75	75	22mm <sup>2</sup> 以上	5.5mm <sup>2</sup> 以上
	基本ユニット	75A 100mA 0.1s以下	75	75	75	22mm <sup>2</sup> 以上	5.5mm <sup>2</sup> 以上
PUHY-P1010SKM-E	システムユニット	75A 100mA 0.1s以下	75	75	75	22mm <sup>2</sup> 以上	5.5mm <sup>2</sup> 以上
	基本ユニット	75A 100mA 0.1s以下	75	75	75	22mm <sup>2</sup> 以上	5.5mm <sup>2</sup> 以上
PUHY-P1080SKM-E	システムユニット	75A 100mA 0.1s以下	75	75	75	38mm <sup>2</sup> 以上	5.5mm <sup>2</sup> 以上
	基本ユニット	75A 100mA 0.1s以下	75	75	75	38mm <sup>2</sup> 以上	5.5mm <sup>2</sup> 以上
PUHY-P1130SKM-E	システムユニット	75A 100mA 0.1s以下	75	75	75	38mm <sup>2</sup> 以上	5.5mm <sup>2</sup> 以上
	基本ユニット	75A 100mA 0.1s以下	75	75	75	38mm <sup>2</sup> 以上	5.5mm <sup>2</sup> 以上
PUHY-P1180SKM-E	システムユニット	75A 100mA 0.1s以下	75	75	75	38mm <sup>2</sup> 以上	5.5mm <sup>2</sup> 以上
	基本ユニット	75A 100mA 0.1s以下	75	75	75	38mm <sup>2</sup> 以上	5.5mm <sup>2</sup> 以上
PUHY-P1240SKM-E	システムユニット	100A 100mA 0.1s以下	100	100	100	38mm <sup>2</sup> 以上	5.5mm <sup>2</sup> 以上
	基本ユニット	100A 100mA 0.1s以下	100	100	100	38mm <sup>2</sup> 以上	5.5mm <sup>2</sup> 以上
PUHY-P1300SKM-E	システムユニット	100A 100mA 0.1s以下	100	100	100	38mm <sup>2</sup> 以上	5.5mm <sup>2</sup> 以上
	基本ユニット	100A 100mA 0.1s以下	100	100	100	38mm <sup>2</sup> 以上	5.5mm <sup>2</sup> 以上
PUHY-P1360SKM-E	システムユニット	100A 100mA 0.1s以下	100	100	100	38mm <sup>2</sup> 以上	5.5mm <sup>2</sup> 以上
	基本ユニット	100A 100mA 0.1s以下	100	100	100	38mm <sup>2</sup> 以上	5.5mm <sup>2</sup> 以上
PUHY-P1400SKM-E	システムユニット	100A 100mA 0.1s以下	100	100	100	60mm <sup>2</sup> 以上	5.5mm <sup>2</sup> 以上
	基本ユニット	100A 100mA 0.1s以下	100	100	100	60mm <sup>2</sup> 以上	5.5mm <sup>2</sup> 以上

< P960 ~ P1400形 > (一括配線接続の場合)

セット形名		漏電遮断器	手元開閉器		配線用遮断器 (NFB)<A>	一括電源 配線太さ	分岐後 電源配線太さ	接地線太さ
			開閉器容量<A>	過電流保護器<A>				
PUHY-P960SKM-E	システムユニット	150A 100mA 0.1s以下	150	150	150	100mm <sup>2</sup>	22mm <sup>2</sup> 以上 1	5.5mm <sup>2</sup> 以上
	基本ユニット	150A 100mA 0.1s以下	150	150	150	100mm <sup>2</sup>	22mm <sup>2</sup> 以上 1	5.5mm <sup>2</sup> 以上
PUHY-P1010SKM-E	システムユニット	150A 100mA 0.1s以下	150	150	150	100mm <sup>2</sup>	22mm <sup>2</sup> 以上 1	5.5mm <sup>2</sup> 以上
	基本ユニット	150A 100mA 0.1s以下	150	150	150	100mm <sup>2</sup>	22mm <sup>2</sup> 以上 1	5.5mm <sup>2</sup> 以上
PUHY-P1080SKM-E	システムユニット	150A 100mA 0.1s以下	150	150	150	100mm <sup>2</sup>	38mm <sup>2</sup> 以上	5.5mm <sup>2</sup> 以上
	基本ユニット	150A 100mA 0.1s以下	150	150	150	100mm <sup>2</sup>	38mm <sup>2</sup> 以上	5.5mm <sup>2</sup> 以上
PUHY-P1130SKM-E	システムユニット	150A 100mA 0.1s以下	150	150	150	100mm <sup>2</sup>	38mm <sup>2</sup> 以上	5.5mm <sup>2</sup> 以上
	基本ユニット	150A 100mA 0.1s以下	150	150	150	100mm <sup>2</sup>	38mm <sup>2</sup> 以上	5.5mm <sup>2</sup> 以上
PUHY-P1180SKM-E	システムユニット	150A 100mA 0.1s以下	150	150	150	100mm <sup>2</sup>	38mm <sup>2</sup> 以上	5.5mm <sup>2</sup> 以上
	基本ユニット	150A 100mA 0.1s以下	150	150	150	100mm <sup>2</sup>	38mm <sup>2</sup> 以上	5.5mm <sup>2</sup> 以上
PUHY-P1240SKM-E	システムユニット	175A 100mA 0.1s以下	175	175	175	100mm <sup>2</sup>	38mm <sup>2</sup> 以上	5.5mm <sup>2</sup> 以上
	基本ユニット	175A 100mA 0.1s以下	175	175	175	100mm <sup>2</sup>	38mm <sup>2</sup> 以上	5.5mm <sup>2</sup> 以上
PUHY-P1300SKM-E	システムユニット	175A 100mA 0.1s以下	175	175	175	100mm <sup>2</sup>	38mm <sup>2</sup> 以上	5.5mm <sup>2</sup> 以上
	基本ユニット	175A 100mA 0.1s以下	175	175	175	100mm <sup>2</sup>	38mm <sup>2</sup> 以上	5.5mm <sup>2</sup> 以上
PUHY-P1360SKM-E	システムユニット	175A 100mA 0.1s以下	175	175	175	100mm <sup>2</sup>	38mm <sup>2</sup> 以上	5.5mm <sup>2</sup> 以上
	基本ユニット	175A 100mA 0.1s以下	175	175	175	100mm <sup>2</sup>	38mm <sup>2</sup> 以上	5.5mm <sup>2</sup> 以上
PUHY-P1400SKM-E	システムユニット	175A 100mA 0.1s以下	175	175	175	100mm <sup>2</sup>	60mm <sup>2</sup> 以上	5.5mm <sup>2</sup> 以上
	基本ユニット	175A 100mA 0.1s以下	175	175	175	100mm <sup>2</sup>	60mm <sup>2</sup> 以上	5.5mm <sup>2</sup> 以上

1.分岐後の配線長さが8mを超える場合は、38mm<sup>2</sup>の配線径をご使用ください。

## 室内ユニット

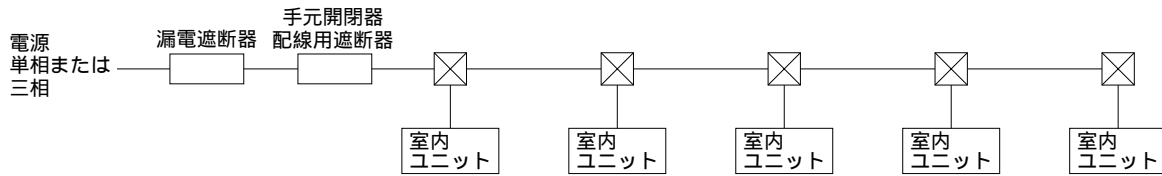

			最小太さ			手元開閉器 A		配線用遮断器 A	漏電遮断器 (注1、2)
			幹線	分岐	アース	開閉器容量	過電流保護器(注3)		
全機種 (PFFY-DM形除く)	合計運転電流 (注4)	15A未満	1.6mm	1.6mm	-	15	15	15	15A 30mA 0.1s以下
		20A未満	2.0mm	2.0mm	-	20	20	20	20A 30mA 0.1s以下
		30A未満	5.5mm <sup>2</sup>	5.5mm <sup>2</sup>	-	30	30	30	30A 30mA 0.1s以下

### PFFY-DM形

	電動機出力	最小太さ		手元開閉器 A		配線用遮断器 A	漏電遮断器 (注1、2)
		幹線	アース	開閉器容量	過電流保護器(注3)		
PFFY-P224・280DM-E	1.5kW	1.6mm	1.6mm	15	15	15	15A 30mA 0.1s以下
	2.2kW	1.6mm	1.6mm	30	20	30	30A 30mA 0.1s以下
PFFY-P450DM-E	2.2kW	1.6mm	1.6mm	30	20	30	30A 30mA 0.1s以下
	3.7kW	1.6mm	1.6mm	30	30	30	30A 30mA 0.1s以下
PFFY-P560DM-E	3.7kW	1.6mm	1.6mm	30	30	30	30A 30mA 0.1s以下
	5.5kW	5.5mm <sup>2</sup>	5.5mm <sup>2</sup>	60	50	75	75A 100mA 0.1s以下

(注1) 電源には必ず漏電遮断器を取付けてください

(注2) 漏電遮断器で地絡保護専用のものは、手元開閉器または配線用遮断器を組合わせて使用してください

(注3) 過電流保護器はB種ヒューズを使用する場合について示します。

(注4) 室内ユニットの合計運転電流は運転状態によって変動することがありますので、遮断器誤作動防止のため、カタログ値等で求めた電流値より20%程度大きい値で遮断器等を選定してください。

## システムコントローラー

- ・電線の太さ 0.75mm<sup>2</sup>～



### (3)制御箱および配線接続位置

P140・P160・P224・P280・P335・P355・P400・P450形の場合

#### 制御箱および配線接続位置

(イ)サービスパネルは、上部および下部のネジ計5本を外し、手前に引くと、外せます。(下図参照)

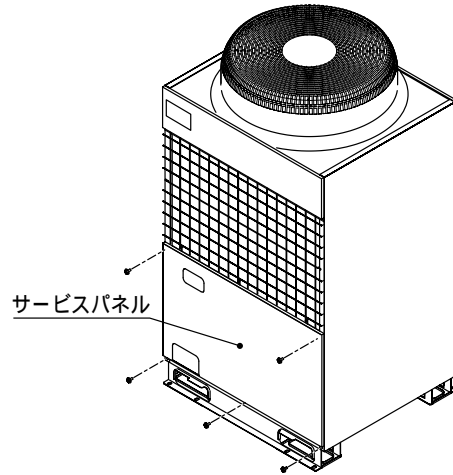

(ロ)室内外伝送線は伝送線用端子台(TB3)に、室外ユニット間または集中管理システムとの配線は集中管理用端子台(TB7)に接続してください。

シールドアースは、室内外伝送線の場合は伝送線用アースネジへ、室外ユニット間または集中管理システムの伝送線の場合は集中管理用端子台(TB7)のシールド(S)端子へ接続してください。尚、給電コネクタをCN41からCN40に差換えた室外ユニットの場合は、上記に加えて集中管理用端子台(TB7)のシールド(S)端子を伝送線用アースネジに接続してください。

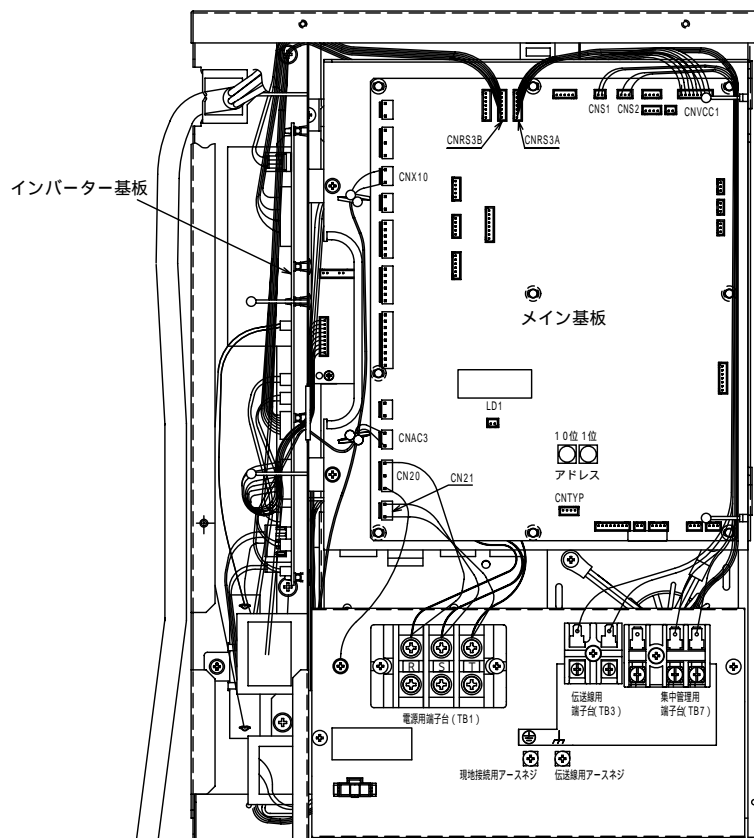

#### 電線管取付板の使用法

電線管取付板( 27、 33 )が付属しています。使用する電線管の外径から取付板を選択し取付けてください。

## P500・P560・P630・P674・P730形の場合

### 制御箱および配線接続位置

#### 室外ユニット

(イ)サーブパネルは、上部および下部のネジ計5本を外し、手前に引くと、外せます。(下図参照)

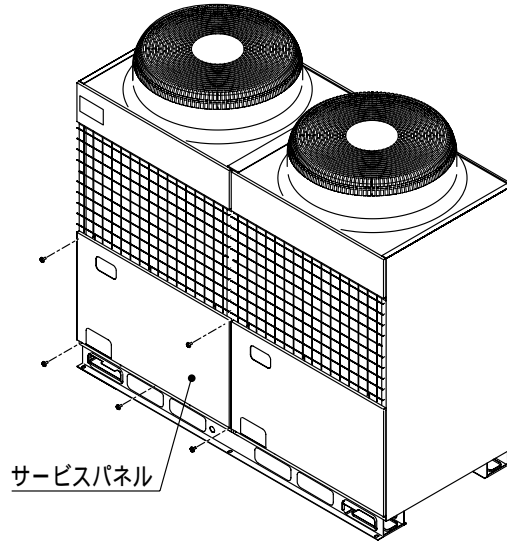

(ロ)室内外伝送線は伝送線用端子台(TB3)に、室外ユニット間または集中管理システムとの配線は集中管理用端子台(TB7)に接続してください。

シールドアースは、室内外伝送線の場合は伝送線用アースネジへ、室外ユニット間または集中管理システムの伝送線の場合は集中管理用端子台(TB7)のシールド(S)端子へ接続してください。

なお、給電コネクタをCN41からCN40に差換えた室外ユニットの場合は、上記に加えて集中管理用端子台(TB7)のシールド(S)端子を伝送線用アースネジに接続してください。

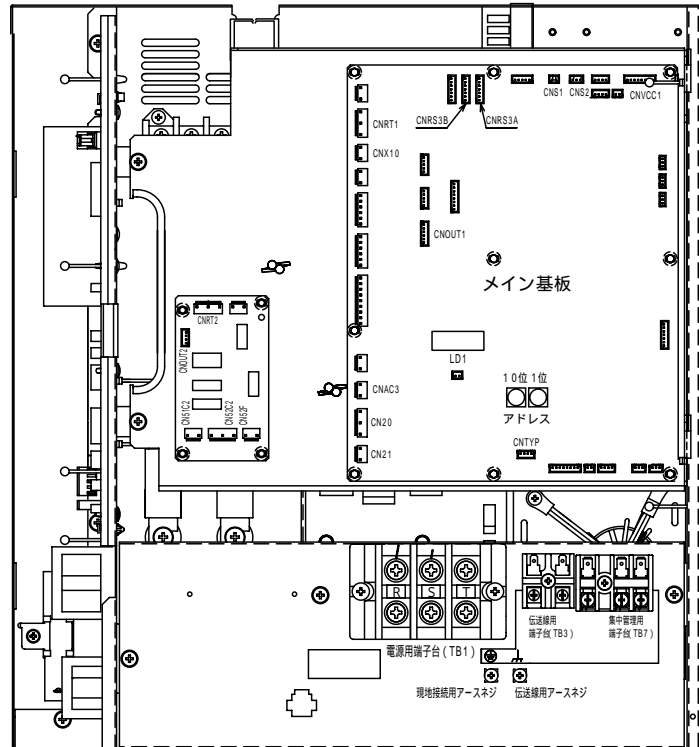

#### 電線管取付板の使用方法

電線管取付板( 53、 46)が付属しています。  
使用する電線管の外径から取付板を選択し取付けてください。

## PVHN-P100SM-E形

### 室外ユニット

( a ) サービスパネルは、上部および下部のネジ計7本を外し、手前に引くと、外せます。( 下図参照 )

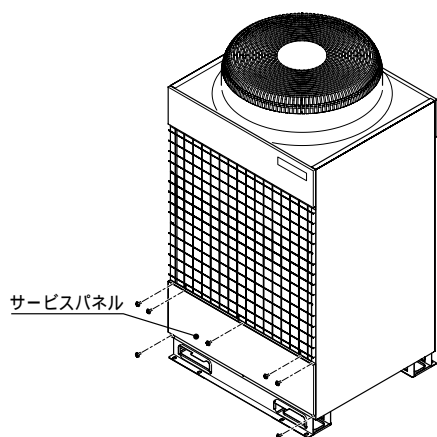

( b ) 制御箱カバーは、制御箱下のネジ3本を外し、下に引っ張ると外せます。( 制御箱カバーを外した状態を下図に示します。)

( c ) 室内外伝送線は、伝送用端子台 ( TB3 ) に、室外ユニット間又は集中管理システムとの配線は、集中管理用端子台 ( TB7 ) に接続してください。

シールド線使用の場合、シールドアースは、室内外伝送線の場合は、アースネジ ( E ) へ、室外ユニット間又は集中管理システムの伝送線の場合は、集中管理用端子台 ( TB7 ) のシールド線 ( S ) 端子へ接続してください。

なお、給電コネクタをCN41からCN40に差換えた室外ユニットの場合は、上記に加えて集中管理用端子台 ( TB7 ) のシールド ( S ) 端子をアースネジ ( E ) に接続してください。

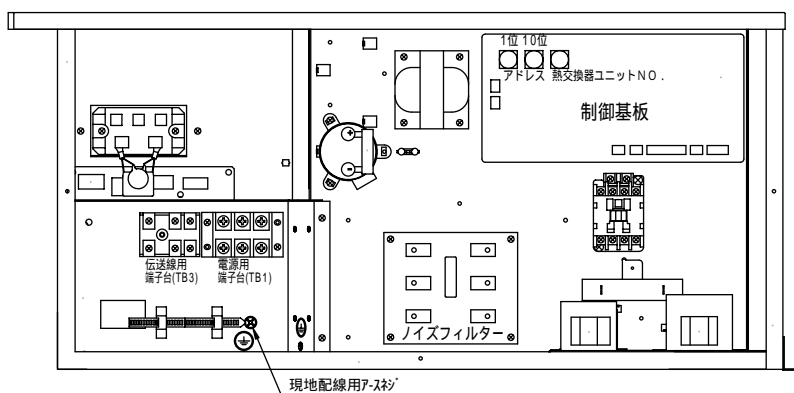

## PUHY-P684・P740・P800SM-E形

( a ) サービスパネルは、上部および下部のネジ計 9本を外し、手前に引くと、外せます。  
( 下図参照 )

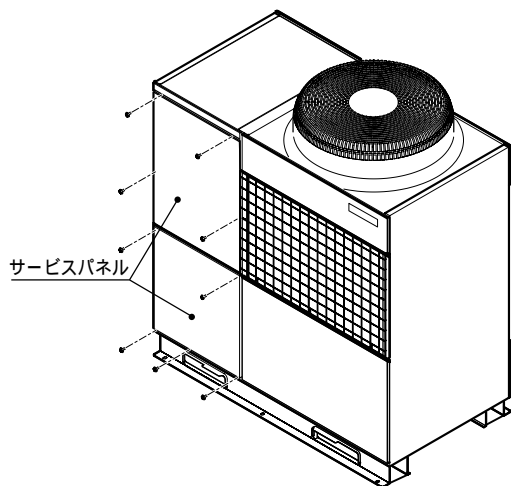

( b ) 制御箱カバーは制御箱下のネジ ( 2本 ) を外して下に引張ると外せます。  
( 制御箱カバーを外した状態を下図に示します。 )

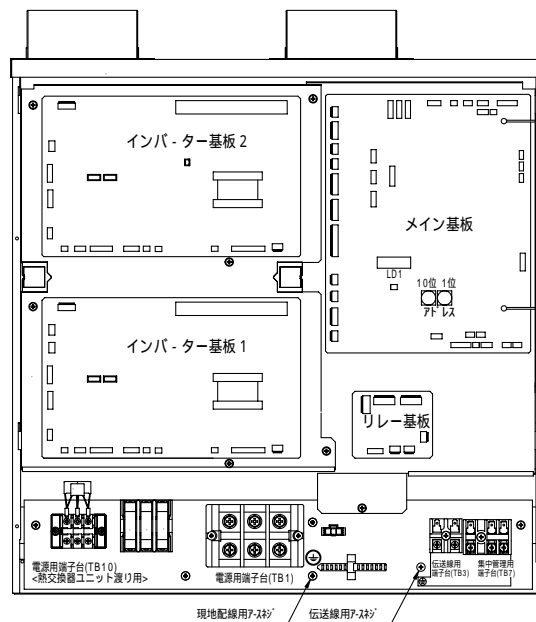

( c ) 配線接続

伝送線用端子台 ( TB3 ) A・Bに、室内系伝送線 ( 定速ユニット、蓄熱槽ユニット含む ) を接続してください。  
( シールドアースは、アースネジ ( E ) へ接続してください。 ) 集中管理用端子台 ( TB7 ) A・Bに、集中系伝送線を接続してください。集中管理用端子台 ( TB7 ) Sに、集中系伝送線のシールドを接続してください。

### 電線管取付板の使用方法

電線管取付板 ( 53 ) が付属しています。使用する電線管の外径から取付板を選択し取付けてください。

### 伝送線用拡張ユニット

室内ユニット接続台数により、伝送線用給電拡張ユニットが必要となります。

( 詳しくは268ページ ( 4 ) 項を参照してください。 )

- ・電源端子台 ( TB1 ) R・Sに、AC200Vを接続してください。
- ・電源端子台 ( TB1 ) アースに、アースを行ってください。
- ・伝送線用端子台1 ( TB2 ) A・Bに、室外ユニット側の伝送線を接続してください。
- ・伝送線用端子台1 ( TB2 ) Sに、室外ユニット側のシールド線を接続してください。
- ・伝送線用端子台2 ( TB3 ) A・Bに、増設室内ユニット側の伝送線を接続してください。
- ・伝送線用端子台2 ( TB3 ) Sに、増設室内ユニット側のシールド線を接続してください。

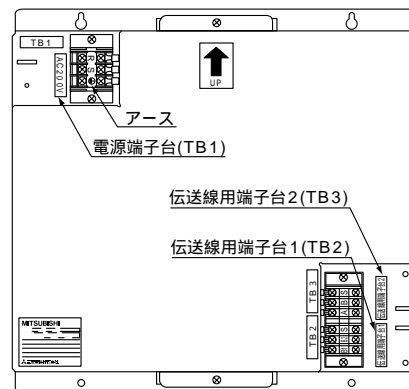

PUHY-P500・P560・P630・P670・P730SM-E形の場合  
 PUHY-P450・P730KM-E形の場合

制御箱および配線接続位置

室外ユニット

(イ)サービスパネルは、上部および下部のネジ計5本を外し、手前に引くと、外せます。(下図参照)

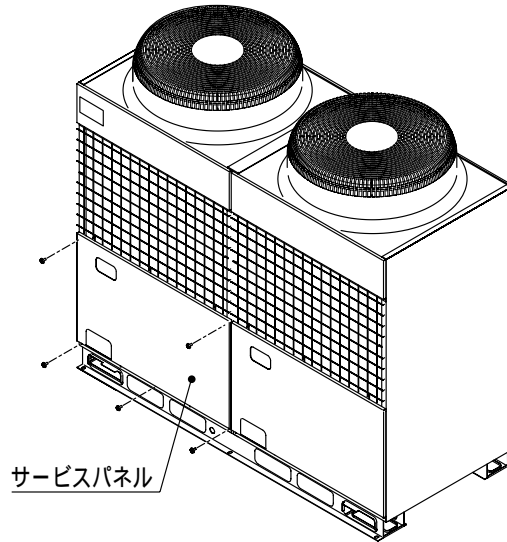

(ロ)室内外伝送線は伝送線用端子台(TB3)に、室外ユニット間または集中管理システムとの配線は集中管理用端子台(TB7)に接続してください。

シールドアースは、室内外伝送線の場合は伝送線用アースネジへ、室外ユニット間または集中管理システムの伝送線の場合は集中管理用端子台(TB7)のシールド(S)端子へ接続してください。

なお、給電コネクタをCN41からCN40に差換えた室外ユニットの場合は、上記に加えて集中管理用端子台(TB7)のシールド(S)端子を伝送線用アースネジに接続してください。

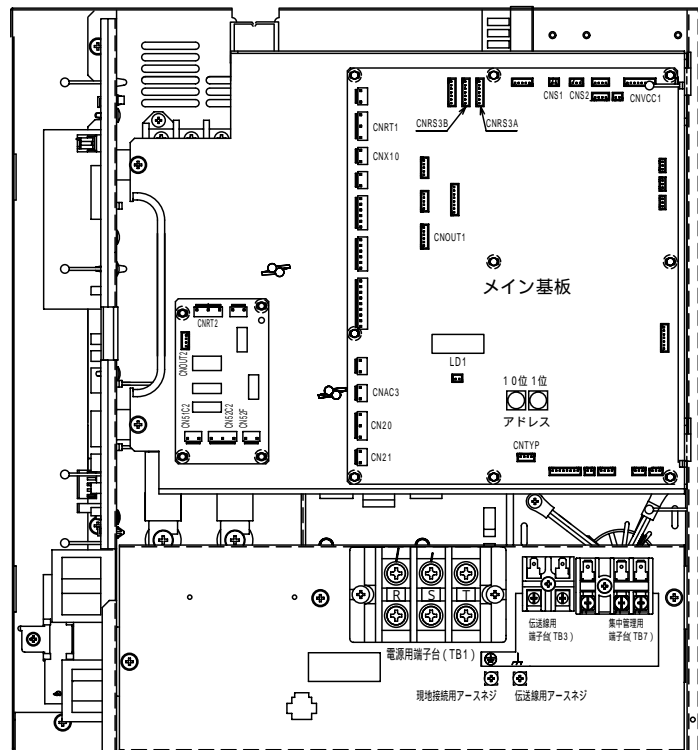

電線管取付板の使用方法

電線管取付板( 53、 46)が付属しています。  
 使用する電線管の外径から取付板を選択し取付けてください。

# (4) 基本システムの機外配線図例

## P140～P730の場合

### MAリモコンを用いたシステム例

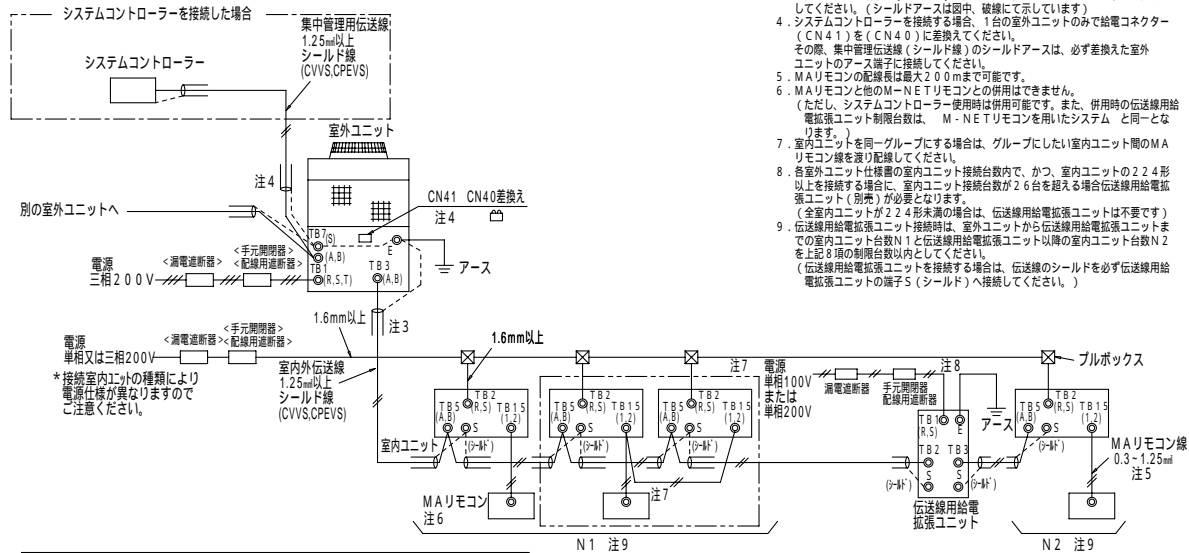

形名	漏電遮断器 *1, *2	手元開閉器 開閉容量 <A>	過電流保護器 <A> *3	配線用遮断器 (NFB) <A>	電源配線太さ <mm>	接地線太さ <mm>
PUHY-P140ME	30A 100mA 0.1s以下	3.0	3.0	3.0	5.5以上	2以上
PUHY-P160ME	30A 100mA 0.1s以下	3.0	3.0	3.0	5.5以上	2以上
PUHY-P224ME	40A 100mA 0.1s以下	6.0	4.0	4.0	8以上	3.5以上
PUHY-P280ME	50A 100mA 0.1s以下	6.0	5.0	5.0	1.4以上	3.5以上
PUHY-P335ME	60A 100mA 0.1s以下	6.0	5.0	6.0	1.4以上	5.5以上
PUHY-P355ME	60A 100mA 0.1s以下	6.0	6.0	6.0	1.4以上	5.5以上
PUHY-P400ME	60A 100mA 0.1s以下	6.0	6.0	6.0	2.2以上	5.5以上
PUHY-P450ME	75A 100mA 0.1s以下	7.5	7.5	7.5	2.2以上	5.5以上
PUHY-P500ME	75A 100mA 0.1s以下	7.5	7.5	7.5	3.8以上	5.5以上
PUHY-P560ME	75A 100mA 0.1s以下	7.5	7.5	7.5	3.8以上	5.5以上
PUHY-P630ME	100A 100mA 0.1s以下	10.0	10.0	10.0	3.8以上	5.5以上
PUHY-P674ME	100A 100mA 0.1s以下	10.0	10.0	10.0	6.0以上	5.5以上
PUHY-P730ME	100A 100mA 0.1s以下	10.0	10.0	10.0	6.0以上	5.5以上

- \*1 電源には必ず漏電遮断器を取付けてください。
- \*2 漏電遮断器で地絡保護専用のものは手元開閉器または配線用遮断器を組合わせて使用してください。
- \*3 過電流保護器はB種ヒューズを使用する場合について示します。

MAリモコンを用いたシステム

### M-NETリモコンを用いたシステム例

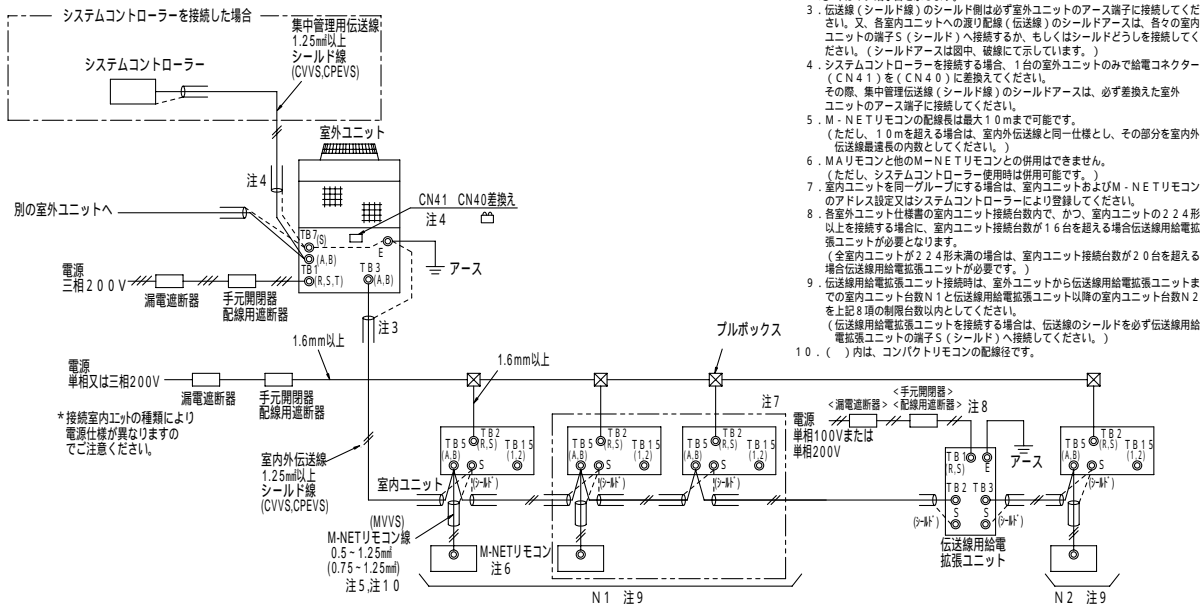

形名	漏電遮断器 *1, *2	手元開閉器 開閉容量 <A>	過電流保護器 <A> *3	配線用遮断器 (NFB) <A>	電源配線太さ <mm>	接地線太さ <mm>
PUHY-P140ME	30A 100mA 0.1s以下	3.0	3.0	3.0	5.5以上	2以上
PUHY-P160ME	30A 100mA 0.1s以下	3.0	3.0	3.0	5.5以上	2以上
PUHY-P224ME	40A 100mA 0.1s以下	6.0	4.0	4.0	8以上	3.5以上
PUHY-P280ME	50A 100mA 0.1s以下	6.0	5.0	5.0	1.4以上	3.5以上
PUHY-P335ME	60A 100mA 0.1s以下	6.0	5.0	6.0	1.4以上	5.5以上
PUHY-P355ME	60A 100mA 0.1s以下	6.0	6.0	6.0	1.4以上	5.5以上
PUHY-P400ME	60A 100mA 0.1s以下	6.0	6.0	6.0	2.2以上	5.5以上
PUHY-P450ME	75A 100mA 0.1s以下	7.5	7.5	7.5	2.2以上	5.5以上
PUHY-P500ME	75A 100mA 0.1s以下	7.5	7.5	7.5	3.8以上	5.5以上
PUHY-P560ME	75A 100mA 0.1s以下	7.5	7.5	7.5	3.8以上	5.5以上
PUHY-P630ME	100A 100mA 0.1s以下	10.0	10.0	10.0	3.8以上	5.5以上
PUHY-P674ME	100A 100mA 0.1s以下	10.0	10.0	10.0	6.0以上	5.5以上
PUHY-P730ME	100A 100mA 0.1s以下	10.0	10.0	10.0	6.0以上	5.5以上

- \*1 電源には必ず漏電遮断器を取付けてください。
- \*2 漏電遮断器で地絡保護専用のものは手元開閉器または配線用遮断器を組合わせて使用してください。
- \*3 過電流保護器はB種ヒューズを使用する場合について示します。

M-NETリモコンを用いたシステム

## P784 ~ P900の場合

### MAリモコンを用いたシステム例 (室外ユニット電源個別配線接続)

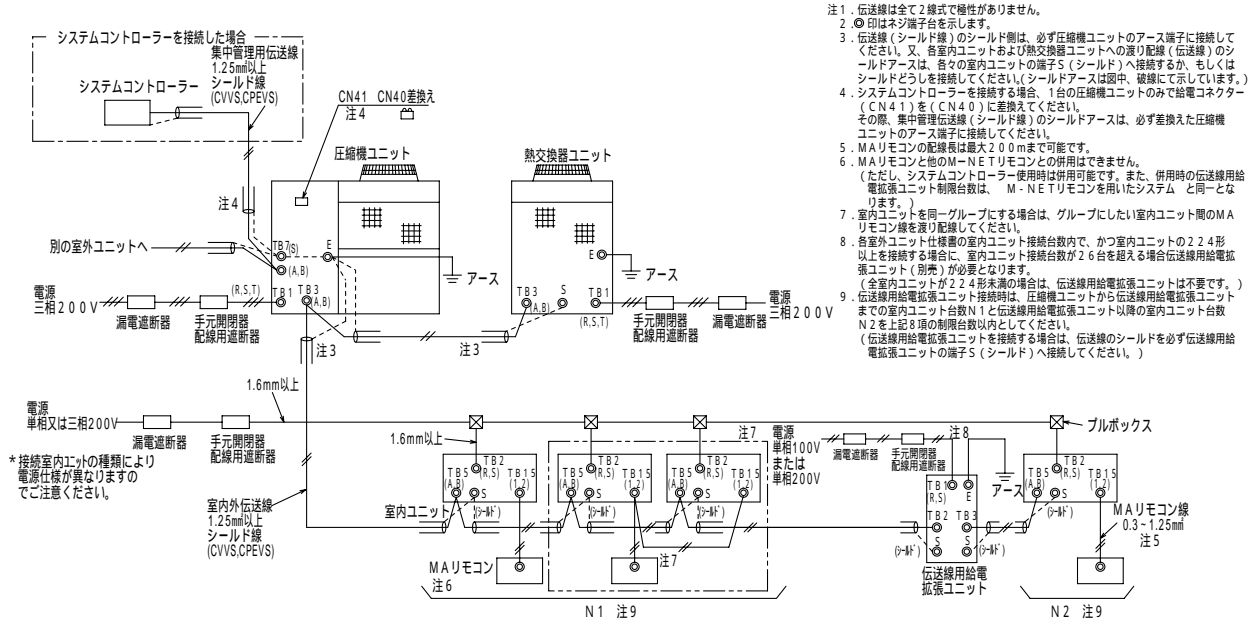

セット形名	構成ユニット形名	漏電遮断器 *1、*2	手元開閉器		配線用遮断器 (NFB) <A>	電源配線太さ <mm>	接地線太さ <mm>	
			開閉器容量 <A>	過電流保護器 <A>*3				
PUHY-P784SM-E	圧縮機ユニット	PUHY-P684SM-E	100A 100mA 0.1s以下	1.00	1.00	1.00	6.0mm以上	5.5以上
	熱交換器ユニット	PVHN-P100SM-E	15A 30mA 0.1s以下	1.5	1.5	1.5	1.6mm以上	1.6以上
PUHY-P840SM-E	圧縮機ユニット	PUHY-P740SM-E	125A 100mA 0.1s以下	2.00	1.25	1.25	6.0mm以上	8以上
	熱交換器ユニット	PVHN-P100SM-E	15A 30mA 0.1s以下	1.5	1.5	1.5	1.6mm以上	1.6以上
PUHY-P900SM-E	圧縮機ユニット	PUHY-P800SM-E	125A 100mA 0.1s以下	2.00	1.25	1.25	6.0mm以上	8以上
	熱交換器ユニット	PVHN-P100SM-E	15A 30mA 0.1s以下	1.5	1.5	1.5	1.6mm以上	1.6以上

- \*1 電源には必ず漏電遮断器を取付けてください。
- \*2 漏電遮断器で地絡保護専用のもは手元開閉器または配線用遮断器を組合わせて使用してください。
- \*3 過電流保護器はB種ヒューズを使用する場合について示します。

MAリモコンを用いたシステム

### MAリモコンを用いたシステム例 (室外ユニット電源渡り配線接続)

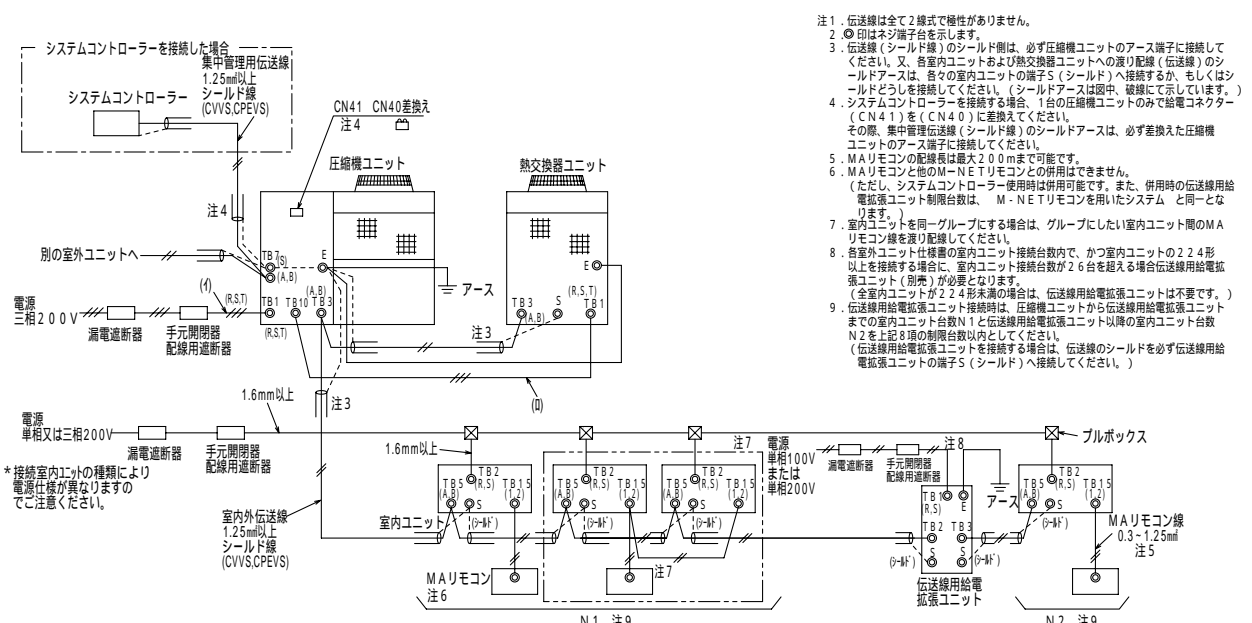

セット形名	構成ユニット形名	漏電遮断器 *1、*2	手元開閉器		配線用遮断器 (NFB) <A>	電源配線太さ <mm>	接地線太さ <mm>	
			開閉器容量 <A>	過電流保護器 <A>*3				
PUHY-P784SM-E	圧縮機ユニット	PUHY-P684SM-E	125A 100mA 0.1s以下	2.00	1.25	1.25	(イ) 6.0mm以上	8以上
	熱交換器ユニット	PVHN-P100SM-E	15A 30mA 0.1s以下	1.5	1.5	1.5	(ロ) 1.6mm以上	1.6以上
PUHY-P840SM-E	圧縮機ユニット	PUHY-P740SM-E	125A 100mA 0.1s以下	2.00	1.25	1.25	(イ) 6.0mm以上	8以上
	熱交換器ユニット	PVHN-P100SM-E	15A 30mA 0.1s以下	1.5	1.5	1.5	(ロ) 1.6mm以上	1.6以上
PUHY-P900SM-E	圧縮機ユニット	PUHY-P800SM-E	150A 100mA 0.1s以下	2.00	1.50	1.50	(イ) 6.0mm以上	8以上
	熱交換器ユニット	PVHN-P100SM-E	15A 30mA 0.1s以下	1.5	1.5	1.5	(ロ) 1.6mm以上	1.6以上

- \*1 電源には必ず漏電遮断器を取付けてください。
- \*2 漏電遮断器で地絡保護専用のもは手元開閉器または配線用遮断器を組合わせて使用してください。
- \*3 過電流保護器はB種ヒューズを使用する場合について示します。

MAリモコンを用いたシステム

## M-NETリモコンを用いたシステム例（室外ユニット電源個別配線接続）

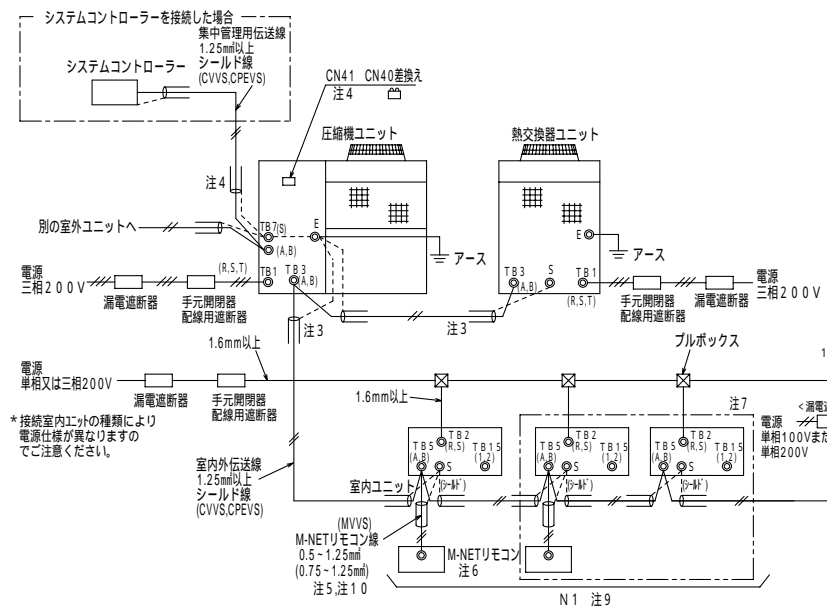

- 注1 伝送線は全て2線式で極性がありません。
- 注2 印はネジ端子を示します。
- 注3 伝送線（シールド線）のシールド側は、必ず圧縮機ユニットのアース端子に接続してください。又、各室内ユニットおよび熱交換器ユニットへの渡り配線（伝送線）のシールドアースは、各々の室内ユニットの端子S（シールド）へ接続するか、もしくはシールドどうしを接続してください。（シールドアースは図中、破線にて示しています。）
- 注4 システムコントローラーを接続する場合、1台の圧縮機ユニットのみで給電コネクタ（CN41）を（CN40）に差換えてください。その際、集中管理用伝送線（シールド線）のシールドアースは、必ず差換えた圧縮機ユニットのアース端子に接続してください。
- 注5 M-NETリモコンの配線長は最大10mまで可能です。（ただし、10mを超える場合は、室内外伝送線と同一仕様とし、その部分を室内外伝送線最長の内数としてください。）
- 注6 MAリモコンと他のM-NETリモコンとの併用はできません。（ただし、システムコントローラー一用時は併用可能です。）
- 注7 室内ユニットを同一グループにする場合は、室内ユニットおよびM-NETリモコンのアドレス設定又はシステムコントローラーにより登録してください。
- 注8 各室外ユニット仕様の室内ユニット接続台数内で、かつ室内ユニットの224形以上を接続する場合は、室内ユニット接続台数が16台を超える場合伝送線用給電拡張ユニットが必要となります。（全室内ユニットが224形未満の場合は、室内ユニット接続台数が20台を超える場合伝送線用給電拡張ユニットが必要です。）
- 注9 伝送線用給電拡張ユニット接続時は、圧縮機ユニットから伝送線用給電拡張ユニットまでの室内ユニット台数N1と伝送線用給電拡張ユニット以降の室内ユニット台数N2を上記8項の制限台数以内としてください。（伝送線用給電拡張ユニットを接続する場合は、伝送線のシールドを必ず伝送線用給電拡張ユニットの端子S（シールド）へ接続してください。）
- 注10 ( )内は、コンパクトリモコンの配線径です。

セット形名	構成ユニット形名	漏電遮断器 *1、*2	手元開閉器 開閉器容量 <A>	過電流保護器 <A>*3	配線用遮断器 (NFB) <A>	電源配線太さ	接地線太さ <mm>
PUHY-P784SM-E	圧縮機ユニット	PUHY-P684SM-E	100A 100mA 0.1s以下	1 0 0	1 0 0	6.0mm以上	5.5以上
	熱交換器ユニット	PVHN-P100SM-E	15A 30mA 0.1s以下	1 5 1 5	1 5 1 5	1.6mm以上	1.6以上
PUHY-P840SM-E	圧縮機ユニット	PUHY-P740SM-E	125A 100mA 0.1s以下	2 0 0	1 2 5	6.0mm以上	8以上
	熱交換器ユニット	PVHN-P100SM-E	15A 30mA 0.1s以下	1 5 1 5	1 5 1 5	1.6mm以上	1.6以上
PUHY-P900SM-E	圧縮機ユニット	PUHY-P800SM-E	125A 100mA 0.1s以下	2 0 0	1 2 5	6.0mm以上	8以上
	熱交換器ユニット	PVHN-P100SM-E	15A 30mA 0.1s以下	1 5 1 5	1 5 1 5	1.6mm以上	1.6以上

- \*1 電源には必ず漏電遮断器を取付けてください。
- \*2 漏電遮断器で地絡保護専用のものは手元開閉器または配線用遮断器を組合わせて使用してください。
- \*3 過電流保護器はB種ヒューズを使用する場合について示します。

M-NETリモコンを用いたシステム

## M-NETリモコンを用いたシステム例（室外ユニット電源渡り配線接続）

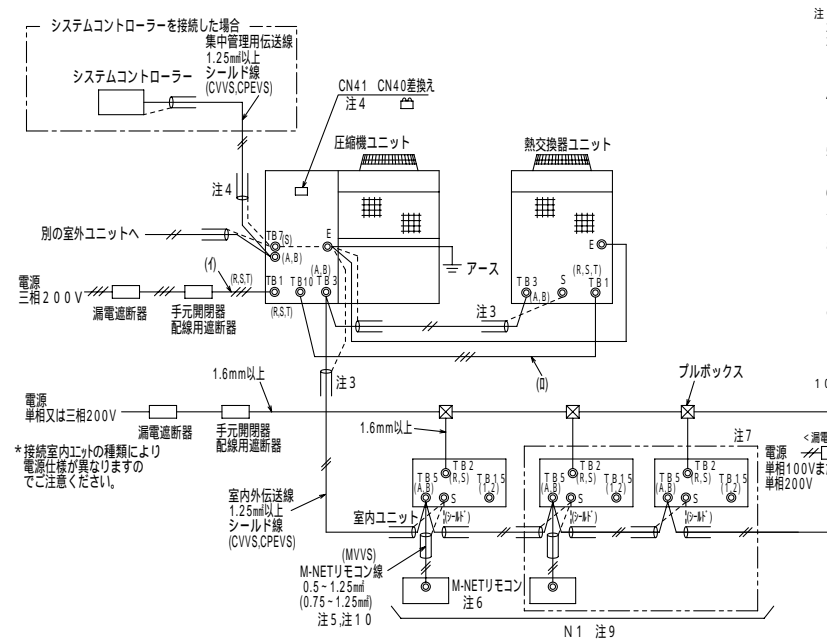

- 注1 伝送線は全て2線式で極性がありません。
- 注2 印はネジ端子を示します。
- 注3 伝送線（シールド線）のシールド側は、必ず圧縮機ユニットのアース端子に接続してください。又、各室内ユニットおよび熱交換器ユニットへの渡り配線（伝送線）のシールドアースは、各々の室内ユニットの端子S（シールド）へ接続するか、もしくはシールドどうしを接続してください。（シールドアースは図中、破線にて示しています。）
- 注4 システムコントローラーを接続する場合、1台の圧縮機ユニットのみで給電コネクタ（CN41）を（CN40）に差換えてください。その際、集中管理用伝送線（シールド線）のシールドアースは、必ず差換えた圧縮機ユニットのアース端子に接続してください。
- 注5 M-NETリモコンの配線長は最大10mまで可能です。（ただし、10mを超える場合は、室内外伝送線と同一仕様とし、その部分を室内外伝送線最長の内数としてください。）
- 注6 MAリモコンと他のM-NETリモコンとの併用はできません。（ただし、システムコントローラー一用時は併用可能です。）
- 注7 室内ユニットを同一グループにする場合は、室内ユニットおよびM-NETリモコンのアドレス設定又はシステムコントローラーにより登録してください。
- 注8 各室外ユニット仕様の室内ユニット接続台数内で、かつ室内ユニットの224形以上を接続する場合は、室内ユニット接続台数が16台を超える場合伝送線用給電拡張ユニットが必要となります。（全室内ユニットが224形未満の場合は、室内ユニット接続台数が20台を超える場合伝送線用給電拡張ユニットが必要です。）
- 注9 伝送線用給電拡張ユニット接続時は、圧縮機ユニットから伝送線用給電拡張ユニットまでの室内ユニット台数N1と伝送線用給電拡張ユニット以降の室内ユニット台数N2を上記8項の制限台数以内としてください。（伝送線用給電拡張ユニットを接続する場合は、伝送線のシールドを必ず伝送線用給電拡張ユニットの端子S（シールド）へ接続してください。）
- 注10 ( )内は、コンパクトリモコンの配線径です。

セット形名	構成ユニット形名	漏電遮断器 *1、*2	手元開閉器 開閉器容量 <A>	過電流保護器 <A>*3	配線用遮断器 (NFB) <A>	電源配線太さ	接地線太さ <mm>
PUHY-P784SM-E	圧縮機ユニット	PUHY-P684SM-E	125A 100mA 0.1s以下	2 0 0	1 2 5	(f) 6.0mm以上	8以上
	熱交換器ユニット	PVHN-P100SM-E	15A 30mA 0.1s以下	(d) 1.6mm以上	1 2 5	1.6mm以上	1.6以上
PUHY-P840SM-E	圧縮機ユニット	PUHY-P740SM-E	125A 100mA 0.1s以下	2 0 0	1 2 5	(f) 6.0mm以上	8以上
	熱交換器ユニット	PVHN-P100SM-E	15A 30mA 0.1s以下	(d) 1.6mm以上	1 2 5	1.6mm以上	1.6以上
PUHY-P900SM-E	圧縮機ユニット	PUHY-P800SM-E	150A 100mA 0.1s以下	2 0 0	1 5 0	(f) 6.0mm以上	8以上
	熱交換器ユニット	PVHN-P100SM-E	15A 30mA 0.1s以下	(d) 1.6mm以上	1 5 0	1.6mm以上	1.6以上

- \*1 電源には必ず漏電遮断器を取付けてください。
- \*2 漏電遮断器で地絡保護専用のものは手元開閉器または配線用遮断器を組合わせて使用してください。
- \*3 過電流保護器はB種ヒューズを使用する場合について示します。

M-NETリモコンを用いたシステム



# P960 ~ P1400の場合

## MAリモコンを用いたシステム例 ( 室外ユニット電源個別配線接続 )

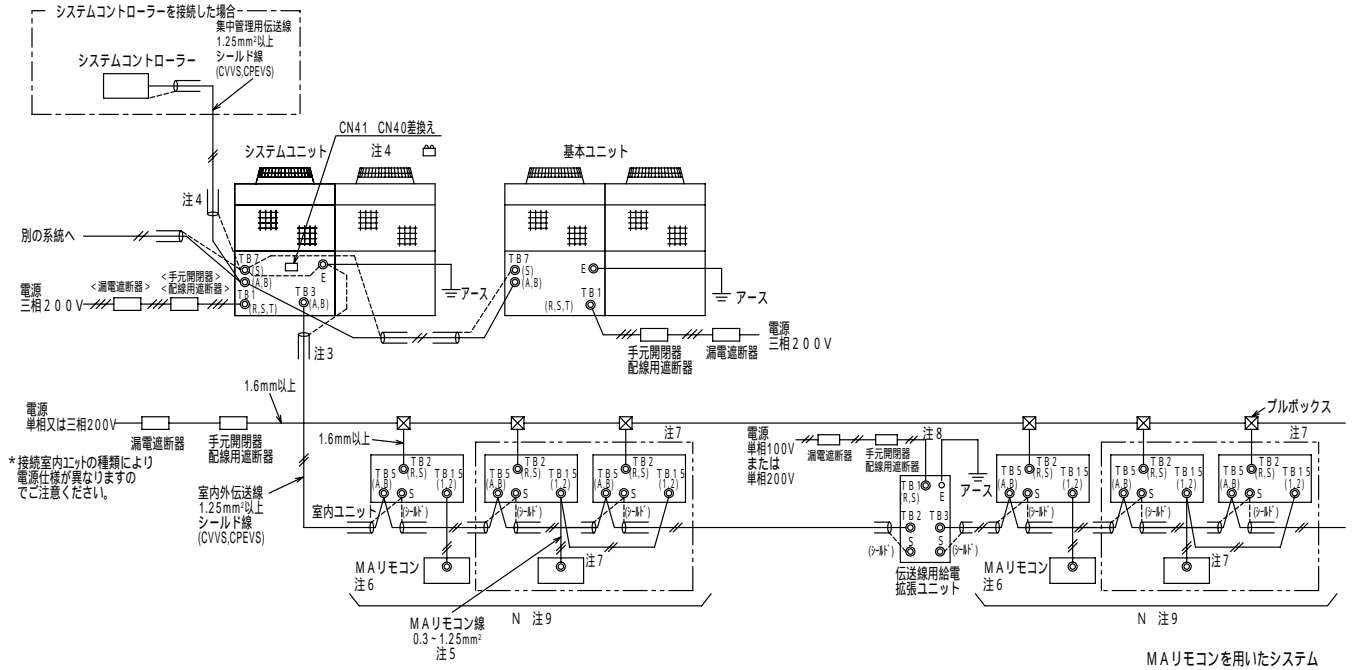

セット名	構成ユニット形名	漏電遮断器 *1, *2	手元開閉器		配線用遮断器 (NFB) <A> *3	電源配線太さ	接地線太さ			
			開閉容量 <A>	絶電圧保護型 <A>						
PUHY-P960SKM-E	システムユニット	PUHY-P500SM-E	75A	100mA	0.1s以下	7.5	7.5	7.5	2.2mm <sup>2</sup> 以上	5.5mm <sup>2</sup> 以上
	基本ユニット	PUHY-P450KM-E	75A	100mA	0.1s以下	7.5	7.5	7.5	2.2mm <sup>2</sup> 以上	5.5mm <sup>2</sup> 以上
PUHY-P1010SKM-E	システムユニット	PUHY-P560SM-E	75A	100mA	0.1s以下	7.5	7.5	7.5	2.2mm <sup>2</sup> 以上	5.5mm <sup>2</sup> 以上
	基本ユニット	PUHY-P450KM-E	75A	100mA	0.1s以下	7.5	7.5	7.5	2.2mm <sup>2</sup> 以上	5.5mm <sup>2</sup> 以上
PUHY-P1080SKM-E	システムユニット	PUHY-P630SM-E	75A	100mA	0.1s以下	7.5	7.5	7.5	3.8mm <sup>2</sup> 以上	5.5mm <sup>2</sup> 以上
	基本ユニット	PUHY-P450KM-E	75A	100mA	0.1s以下	7.5	7.5	7.5	3.8mm <sup>2</sup> 以上	5.5mm <sup>2</sup> 以上
PUHY-P1130SKM-E	システムユニット	PUHY-P670SM-E	75A	100mA	0.1s以下	7.5	7.5	7.5	3.8mm <sup>2</sup> 以上	5.5mm <sup>2</sup> 以上
	基本ユニット	PUHY-P450KM-E	75A	100mA	0.1s以下	7.5	7.5	7.5	3.8mm <sup>2</sup> 以上	5.5mm <sup>2</sup> 以上
PUHY-P1180SKM-E	システムユニット	PUHY-P730SM-E	75A	100mA	0.1s以下	7.5	7.5	7.5	3.8mm <sup>2</sup> 以上	5.5mm <sup>2</sup> 以上
	基本ユニット	PUHY-P450KM-E	75A	100mA	0.1s以下	7.5	7.5	7.5	3.8mm <sup>2</sup> 以上	5.5mm <sup>2</sup> 以上
PUHY-P1240SKM-E	システムユニット	PUHY-P500SM-E	100A	100mA	0.1s以下	10.0	10.0	10.0	3.8mm <sup>2</sup> 以上	5.5mm <sup>2</sup> 以上
	基本ユニット	PUHY-P730KM-E	100A	100mA	0.1s以下	10.0	10.0	10.0	3.8mm <sup>2</sup> 以上	5.5mm <sup>2</sup> 以上
PUHY-P1300SKM-E	システムユニット	PUHY-P560SM-E	100A	100mA	0.1s以下	10.0	10.0	10.0	3.8mm <sup>2</sup> 以上	5.5mm <sup>2</sup> 以上
	基本ユニット	PUHY-P730KM-E	100A	100mA	0.1s以下	10.0	10.0	10.0	3.8mm <sup>2</sup> 以上	5.5mm <sup>2</sup> 以上
PUHY-P1360SKM-E	システムユニット	PUHY-P630SM-E	100A	100mA	0.1s以下	10.0	10.0	10.0	3.8mm <sup>2</sup> 以上	5.5mm <sup>2</sup> 以上
	基本ユニット	PUHY-P730KM-E	100A	100mA	0.1s以下	10.0	10.0	10.0	3.8mm <sup>2</sup> 以上	5.5mm <sup>2</sup> 以上
PUHY-P1400SKM-E	システムユニット	PUHY-P670SM-E	100A	100mA	0.1s以下	10.0	10.0	10.0	6.0mm <sup>2</sup> 以上	5.5mm <sup>2</sup> 以上
	基本ユニット	PUHY-P730KM-E	100A	100mA	0.1s以下	10.0	10.0	10.0	6.0mm <sup>2</sup> 以上	5.5mm <sup>2</sup> 以上

\*1 電源には必ず漏電遮断器を取付けてください。  
 \*2 漏電遮断器で地絡保護専用のものは手元開閉器または配線用遮断器を組合わせて使用してください。  
 \*3 過電流保護器はB種ヒューズを使用する場合について示します。

- 1 伝送線は全て2線式で極性がありません。
- 2 ◎印はネジ端子台を示します。
- 3 伝送線(シールド線)のシールド側は、必ずシステムユニットのアース端子に接続してください。又、各室内ユニットへの渡り配線(伝送線)のシールドアースは、各々の室内ユニットの端子S(シールド)へ接続するか、もしくはシールドどうしを接続してください。(シールドアースは図中、破線で示しています。)
- 4 システムユニットで給電コネクター(CN41)を(CN40)に差換えてください。システムコントローラを接続する場合は、給電コネクターの差換えはシステム内で1台としてください。給電コネクターを差換えたシステムユニットで集中管理伝送線(シールド線)のシールドアースをユニットのアース端子に接続してください。
- 5 MAリモコンの配線長は最大200mまで可能です。
- 6 MAリモコンと他のM-NETリモコンとの併用はできません。(ただし、システムコントローラ使用時は併用可能です。また、併用時の伝送線用給電ユニット必要台数は、M-NETリモコンを用いたシステムを参照ください。)
- 7 室内ユニットを同一グループにする場合は、グループにしたい室内ユニット間のMAリモコン線を渡り配線してください。
- 8 室内ユニット接続台数が以下の台数の場合は、伝送線用給電ユニット(別売)が必要となります。

	伝送線用給電ユニット(別売)必要台数		制限台数(N)
	1台	2台	
接続される室内ユニットが2.2.4形未満の場合	3	4	3
接続される室内ユニットに2.2.4形以上が含まれる場合	2	4	2

- 9 伝送線用給電ユニット接続時は、システムユニットから伝送線用給電ユニットまでの室内ユニット台数Nと伝送線用給電ユニット以降の室内ユニット台数Nを上記8項の制限台数以内としてください。(伝送線用給電ユニットを接続する場合は、伝送線のシールドを必ず伝送線用給電ユニットの端子S(シールド)へ接続してください。)

# MAリモコンを用いたシステム例（室外ユニット電源一括配線接続）

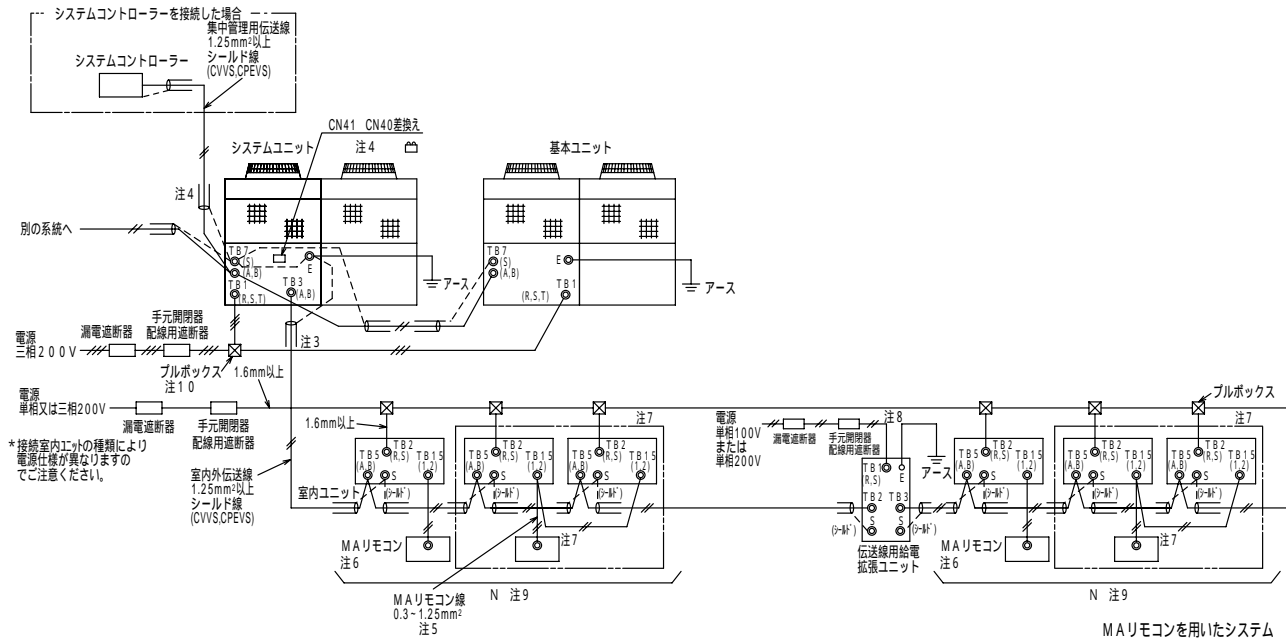

セット形名	漏電遮断器 *1, *2	手元開閉器		配線用遮断器 (NFB)	一括電源 配線寸法	構成ユニット形名	分岐後 電源配線寸法	接地線寸法
		開閉容量 <A>	過電流保護器 <A> *3					
PUHY-P960SKM-E	150A 100mA 0.1s以下	150	150	150	100mm <sup>2</sup>	システムユニット PUHY-P500SM-E 基本ユニット PUHY-P450KM-E	2.2mm <sup>2</sup> 以上*4 2.2mm <sup>2</sup> 以上*4	5.5mm <sup>2</sup> 以上 5.5mm <sup>2</sup> 以上
PUHY-P1010SKM-E	150A 100mA 0.1s以下	150	150	150	100mm <sup>2</sup>	システムユニット PUHY-P560SM-E 基本ユニット PUHY-P450KM-E	2.2mm <sup>2</sup> 以上*4 2.2mm <sup>2</sup> 以上*4	5.5mm <sup>2</sup> 以上 5.5mm <sup>2</sup> 以上
PUHY-P1080SKM-E	150A 100mA 0.1s以下	150	150	150	100mm <sup>2</sup>	システムユニット PUHY-P630SM-E 基本ユニット PUHY-P450KM-E	3.8mm <sup>2</sup> 以上 3.8mm <sup>2</sup> 以上	5.5mm <sup>2</sup> 以上 5.5mm <sup>2</sup> 以上
PUHY-P1130SKM-E	150A 100mA 0.1s以下	150	150	150	100mm <sup>2</sup>	システムユニット PUHY-P670SM-E 基本ユニット PUHY-P450KM-E	3.8mm <sup>2</sup> 以上 3.8mm <sup>2</sup> 以上	5.5mm <sup>2</sup> 以上 5.5mm <sup>2</sup> 以上
PUHY-P1180SKM-E	150A 100mA 0.1s以下	150	150	150	100mm <sup>2</sup>	システムユニット PUHY-P730SM-E 基本ユニット PUHY-P450KM-E	3.8mm <sup>2</sup> 以上 3.8mm <sup>2</sup> 以上	5.5mm <sup>2</sup> 以上 5.5mm <sup>2</sup> 以上
PUHY-P1240SKM-E	175A 100mA 0.1s以下	175	175	175	100mm <sup>2</sup>	システムユニット PUHY-P500SM-E 基本ユニット PUHY-P730KM-E	3.8mm <sup>2</sup> 以上 3.8mm <sup>2</sup> 以上	5.5mm <sup>2</sup> 以上 5.5mm <sup>2</sup> 以上
PUHY-P1300SKM-E	175A 100mA 0.1s以下	175	175	175	100mm <sup>2</sup>	システムユニット PUHY-P560SM-E 基本ユニット PUHY-P730KM-E	3.8mm <sup>2</sup> 以上 3.8mm <sup>2</sup> 以上	5.5mm <sup>2</sup> 以上 5.5mm <sup>2</sup> 以上
PUHY-P1360SKM-E	175A 100mA 0.1s以下	175	175	175	100mm <sup>2</sup>	システムユニット PUHY-P630SM-E 基本ユニット PUHY-P730KM-E	3.8mm <sup>2</sup> 以上 3.8mm <sup>2</sup> 以上	5.5mm <sup>2</sup> 以上 5.5mm <sup>2</sup> 以上
PUHY-P1400SKM-E	175A 100mA 0.1s以下	175	175	175	100mm <sup>2</sup>	システムユニット PUHY-P670SM-E 基本ユニット PUHY-P730KM-E	6.0mm <sup>2</sup> 以上 6.0mm <sup>2</sup> 以上	5.5mm <sup>2</sup> 以上 5.5mm <sup>2</sup> 以上

\*1 電源には必ず漏電遮断器を取付けてください。  
 \*2 漏電遮断器で地絡保護専用のものは手元開閉器または配線用遮断器を組合わせて使用してください。  
 \*3 過電流保護器はB種ヒューズを使用する場合について示します。  
 \*4 分岐後の配線長さが8mを超える場合は、3.8mm<sup>2</sup>の配線径をご使用下さい。

注1. 伝送線は全て2線式で極性がありません。  
 2. 印はネジ端子台を示します。  
 3. 伝送線（シールド線）のシールド側は、必ずシステムユニットのアース端子に接続してください。又、各室内ユニットへの配線（伝送線）のシールドアースは、各々の室内ユニットの端子S（シールド）へ接続するか、もしくはシールドどうしを接続してください。（シールドアースは図中、破線にて示しています。）  
 4. システムユニットで給電コネクタ（CN41）を（CN40）に差換えてください。システムコントローラを接続する場合は、給電コネクタの差換えはシステム内で1台としてください。給電コネクタを差換えしたシステムユニットで集中管理伝送線（シールド線）のシールドアースをユニットのアース端子に接続してください。  
 5. MAリモコンの配線長は最大200mまで可能です。  
 6. MAリモコンと他のM-NEリモコンとの併用はできません。（ただし、システムコントローラ使用時は併用可能です。また、併用時の伝送線用給電コネクタ必要台数は、M-NEリモコンを用いたシステムを参照ください。）  
 7. 室内ユニットを同一グループにする場合は、グループにしたい室内ユニット間のMAリモコン線を渡り配線してください。  
 8. 室内ユニット接続台数が以下の台数の場合は、伝送線用給電コネクタ（別売）が必要となります。

	伝送線用給電コネクタ（別売）必要台数		制限台数(N)
	1台	2台	
接続される室内ユニットが2.4形未満の場合	3	4	3
接続される室内ユニットに2.4形以上が含まれる場合	2	7	2

9. 伝送線用給電コネクタ接続時は、システムユニットから伝送線用給電コネクタまでの室内ユニット台数Nと伝送線用給電コネクタ以降の室内ユニット台数Nを上記8項の制限台数以内としてください。（伝送線用給電コネクタを接続する場合は、伝送線のシールドを必ず伝送線用給電コネクタの端子S（シールド）へ接続してください。）  
 10. 電源配線の分岐にはプルボックスを用いてください。（ユニットの電源端子台を用いた渡り配線は行わないでください。）

# M-NETリモコンを用いたシステム例 ( 室外ユニット電源個別配線接続 )

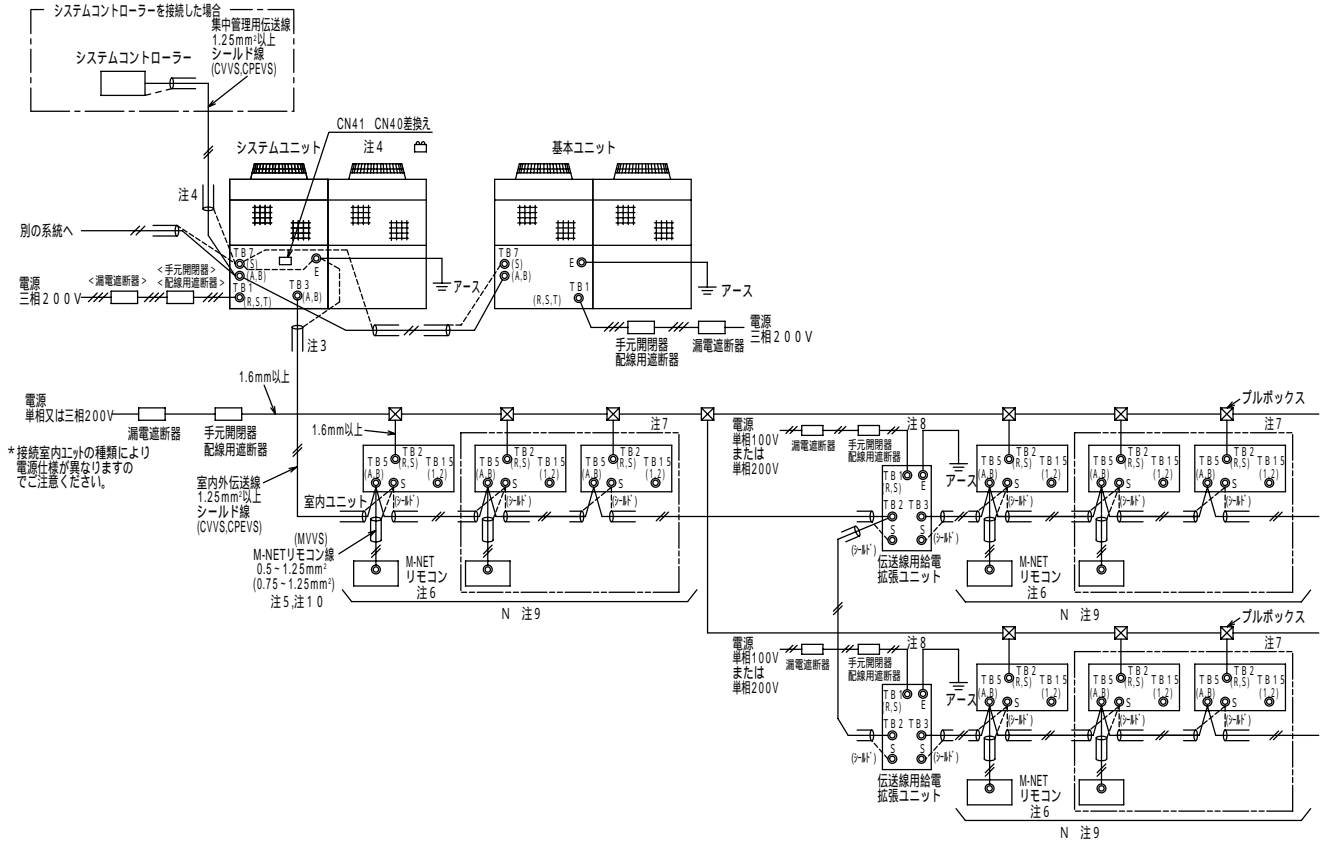

M-NETリモコンを用いたシステム

セット形名	構成ユニット形名	漏電遮断器 * 1, * 2	手元開閉器 開閉器容量 < A >	過電流保護器 < A > * 3	配線用遮断器 ( NFB ) < A >	電源配線太さ	接地線太さ			
PUHY-P960SKM-E	システムユニット	PUHY-P500SM-E	75A	100mA	0.1s以下	7.5	7.5	7.5	2.2mm <sup>2</sup> 以上	5.5mm <sup>2</sup> 以上
	基本ユニット	PUHY-P450KM-E	75A	100mA	0.1s以下	7.5	7.5	7.5	2.2mm <sup>2</sup> 以上	5.5mm <sup>2</sup> 以上
PUHY-P1010SKM-E	システムユニット	PUHY-P560SM-E	75A	100mA	0.1s以下	7.5	7.5	7.5	2.2mm <sup>2</sup> 以上	5.5mm <sup>2</sup> 以上
	基本ユニット	PUHY-P450KM-E	75A	100mA	0.1s以下	7.5	7.5	7.5	2.2mm <sup>2</sup> 以上	5.5mm <sup>2</sup> 以上
PUHY-P1080SKM-E	システムユニット	PUHY-P630SM-E	75A	100mA	0.1s以下	7.5	7.5	7.5	3.8mm <sup>2</sup> 以上	5.5mm <sup>2</sup> 以上
	基本ユニット	PUHY-P450KM-E	75A	100mA	0.1s以下	7.5	7.5	7.5	3.8mm <sup>2</sup> 以上	5.5mm <sup>2</sup> 以上
PUHY-P1130SKM-E	システムユニット	PUHY-P670SM-E	75A	100mA	0.1s以下	7.5	7.5	7.5	3.8mm <sup>2</sup> 以上	5.5mm <sup>2</sup> 以上
	基本ユニット	PUHY-P450KM-E	75A	100mA	0.1s以下	7.5	7.5	7.5	3.8mm <sup>2</sup> 以上	5.5mm <sup>2</sup> 以上
PUHY-P1180SKM-E	システムユニット	PUHY-P730SM-E	75A	100mA	0.1s以下	7.5	7.5	7.5	3.8mm <sup>2</sup> 以上	5.5mm <sup>2</sup> 以上
	基本ユニット	PUHY-P450KM-E	75A	100mA	0.1s以下	7.5	7.5	7.5	3.8mm <sup>2</sup> 以上	5.5mm <sup>2</sup> 以上
PUHY-P1240SKM-E	システムユニット	PUHY-P500SM-E	100A	100mA	0.1s以下	10.0	10.0	10.0	3.8mm <sup>2</sup> 以上	5.5mm <sup>2</sup> 以上
	基本ユニット	PUHY-P730KM-E	100A	100mA	0.1s以下	10.0	10.0	10.0	3.8mm <sup>2</sup> 以上	5.5mm <sup>2</sup> 以上
PUHY-P1300SKM-E	システムユニット	PUHY-P560SM-E	100A	100mA	0.1s以下	10.0	10.0	10.0	3.8mm <sup>2</sup> 以上	5.5mm <sup>2</sup> 以上
	基本ユニット	PUHY-P730KM-E	100A	100mA	0.1s以下	10.0	10.0	10.0	3.8mm <sup>2</sup> 以上	5.5mm <sup>2</sup> 以上
PUHY-P1360SKM-E	システムユニット	PUHY-P630SM-E	100A	100mA	0.1s以下	10.0	10.0	10.0	3.8mm <sup>2</sup> 以上	5.5mm <sup>2</sup> 以上
	基本ユニット	PUHY-P730KM-E	100A	100mA	0.1s以下	10.0	10.0	10.0	3.8mm <sup>2</sup> 以上	5.5mm <sup>2</sup> 以上
PUHY-P1400SKM-E	システムユニット	PUHY-P670SM-E	100A	100mA	0.1s以下	10.0	10.0	10.0	6.0mm <sup>2</sup> 以上	5.5mm <sup>2</sup> 以上
	基本ユニット	PUHY-P730KM-E	100A	100mA	0.1s以下	10.0	10.0	10.0	6.0mm <sup>2</sup> 以上	5.5mm <sup>2</sup> 以上

- \* 1 電源には必ず漏電遮断器を取付けてください。
- \* 2 漏電遮断器で地絡保護専用のものは手元開閉器または配線用遮断器を組合わせて使用してください。
- \* 3 過電流保護器はB種ヒューズを使用する場合について示します。

- 注 1 伝送線は全て2線式で極性がありません。
- 注 2 印はネジ端子台を示します。
- 注 3 伝送線(シールド線)のシールド側は、必ずシステムユニットのアース端子に接続してください。又、各室内ユニットへの渡り配線(伝送線)のシールドアースは、各々の室内ユニットの端子S(シールド)へ接続するか、もしくはシールドどうしを接続してください。(シールドアースは図中、破線で示しています。)
- 注 4 システムユニットで給電コネクタ(CN41)を(CN40)に差換えてください。システムコントローラを接続する場合は、給電コネクタの差換えはシステム内で1台としてください。給電コネクタを差換えたシステムユニットで集中管理伝送線(シールド線)のシールドアースをユニットのアース端子に接続してください。
- 注 5 M-NETリモコンの配線長は最大10mまで可能です。(ただし、10mを超える場合は、室内外伝送線と同一仕様とし、その部分を室内外伝送線延長の内数としてください。)
- 注 6 MAリモコンと他のM-NETリモコンとの併用はできません。(ただし、システムコントローラ使用時は併用可能です。)
- 注 7 室内ユニットを同一グループにする場合は、室内ユニットおよびM-NETリモコンのアドレス設定又はシステムコントローラにより登録してください。
- 注 8 室内ユニット接続台数が以下の台数の場合は、伝送線用給電拡張ユニット(別売)が必要となります。

	伝送線用給電拡張ユニット(別売)必要台数		制限台数(N)
	1台	2台	
接続される室内ユニットが2.2.4形未満の場合	2.1-4.0台	4.1-4.2台	2.0台
接続される室内ユニットに2.2.4形以上が含まれる場合	1.7-3.2台	3.3-4.2台	1.6台

- 注 9 伝送線用給電拡張ユニット接続時は、システムユニットから伝送線用給電拡張ユニットまでの室内ユニット台数Nと伝送線用給電拡張ユニット以降の室内ユニット台数Nを上記8項の制限台数以内としてください。(伝送線用給電拡張ユニットを接続する場合は、伝送線のシールドを必ず伝送線用給電拡張ユニットの端子S(シールド)へ接続してください。)
- 注 10 ( )内は、コンパクトリモコンの配線径です。

# M-NETリモコンを用いたシステム例（室外ユニット電源一括配線接続）

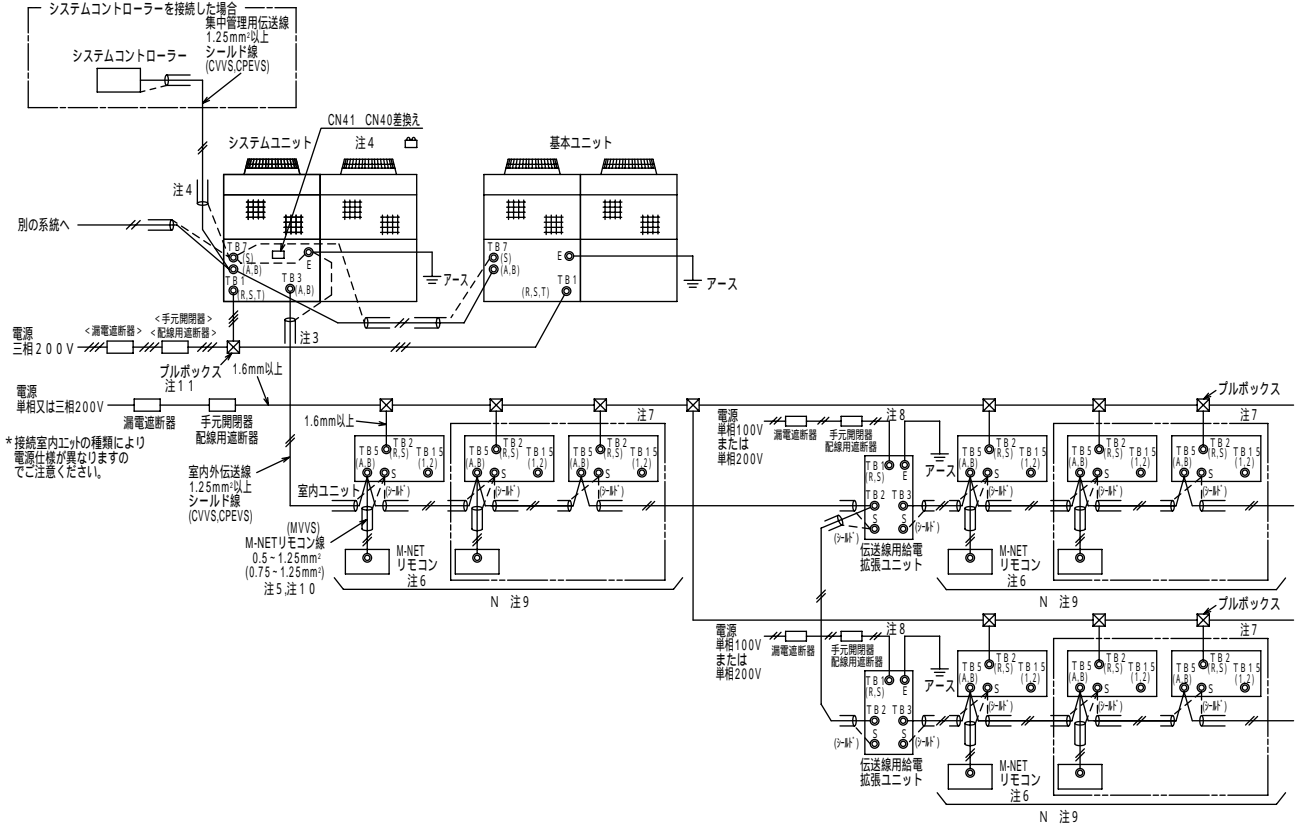

M-NETリモコンを用いたシステム

セット形名	漏電遮断器 *1、*2	手元開閉器 開閉容量 <A>	配線用遮断器 過電流保護器 <A>*3	一括電源 配線太さ	構成ユニット形名	分岐後 電源配線太さ	接地線太さ
PUHY-P960SKM-E	150A 100mA 0.1s以下	1.5	1.5	1.5	システムユニット PUHY-P500SM-E	2.2mm <sup>2</sup> 以上*4	5.5mm <sup>2</sup> 以上
PUHY-P1010SKM-E	150A 100mA 0.1s以下	1.5	1.5	1.5	基本ユニット PUHY-P450KM-E	2.2mm <sup>2</sup> 以上*4	5.5mm <sup>2</sup> 以上
PUHY-P1080SKM-E	150A 100mA 0.1s以下	1.5	1.5	1.5	システムユニット PUHY-P560SM-E	2.2mm <sup>2</sup> 以上*4	5.5mm <sup>2</sup> 以上
PUHY-P1130SKM-E	150A 100mA 0.1s以下	1.5	1.5	1.5	基本ユニット PUHY-P400KM-E	2.2mm <sup>2</sup> 以上*4	5.5mm <sup>2</sup> 以上
PUHY-P1180SKM-E	150A 100mA 0.1s以下	1.5	1.5	1.5	システムユニット PUHY-P630SM-E	3.8mm <sup>2</sup> 以上	5.5mm <sup>2</sup> 以上
PUHY-P1240SKM-E	175A 100mA 0.1s以下	1.75	1.75	1.75	基本ユニット PUHY-P450KM-E	3.8mm <sup>2</sup> 以上	5.5mm <sup>2</sup> 以上
PUHY-P1300SKM-E	175A 100mA 0.1s以下	1.75	1.75	1.75	システムユニット PUHY-P670SM-E	3.8mm <sup>2</sup> 以上	5.5mm <sup>2</sup> 以上
PUHY-P1360SKM-E	175A 100mA 0.1s以下	1.75	1.75	1.75	基本ユニット PUHY-P450KM-E	3.8mm <sup>2</sup> 以上	5.5mm <sup>2</sup> 以上
PUHY-P1400SKM-E	175A 100mA 0.1s以下	1.75	1.75	1.75	システムユニット PUHY-P730SM-E	3.8mm <sup>2</sup> 以上	5.5mm <sup>2</sup> 以上
					基本ユニット PUHY-P670SM-E	3.8mm <sup>2</sup> 以上	5.5mm <sup>2</sup> 以上
					システムユニット PUHY-P560SM-E	3.8mm <sup>2</sup> 以上	5.5mm <sup>2</sup> 以上
					基本ユニット PUHY-P730KM-E	3.8mm <sup>2</sup> 以上	5.5mm <sup>2</sup> 以上
					システムユニット PUHY-P630SM-E	3.8mm <sup>2</sup> 以上	5.5mm <sup>2</sup> 以上
					基本ユニット PUHY-P730KM-E	3.8mm <sup>2</sup> 以上	5.5mm <sup>2</sup> 以上
					システムユニット PUHY-P670SM-E	6.0mm <sup>2</sup> 以上	5.5mm <sup>2</sup> 以上
					基本ユニット PUHY-P730KM-E	6.0mm <sup>2</sup> 以上	5.5mm <sup>2</sup> 以上

\*1 電源には必ず漏電遮断器を取付けてください。  
 \*2 漏電遮断器で地絡保護専用のものは手元開閉器または配線用遮断器を組合わせて使用してください。  
 \*3 過電流保護器は8種ヒューズを使用する場合について示します。  
 \*4 分岐後の配線長さが8mを超える場合は、3.8mm<sup>2</sup>の配線径をご使用下さい。

注1 伝送線は全て2線式で極性がありません。  
 注2 ⊙印はネジ端子台を示します。  
 注3 伝送線（シールド線）のシールド側は、必ずシステムユニットのアース端子に接続してください。又、各室内ユニットへの渡り配線（伝送線）のシールドアースは、各々の室内ユニットの端子S（シールド）へ接続するか、もしくはシールドどうしを接続してください。（シールドアースは図中、破線で示しています。）  
 注4 システムユニットで給電コネクタ（CN41）を（CN40）に差換えてください。システムコントローラを接続する場合は、給電コネクタを差換えずシステム内で1台としてください。給電コネクタを差換えたシステムユニットで集中管理伝送線（シールド線）のシールドアースをユニットのアース端子に接続してください。  
 注5 M-NETリモコンの配線長は最大10mまで可能です。（ただし、10mを超える場合は、室内外伝送線と同一仕様とし、その部分を室内外伝送線最遠長の内数としてください。）  
 注6 M-Aリモコンと他のM-NETリモコンとの併用はできません。（ただし、システムコントローラ使用時は併用可能です。）  
 注7 室内ユニットを同一グループにする場合は、室内ユニットおよびM-NETリモコンのアドレス設定又はシステムコントローラにより登録してください。  
 注8 室内ユニット接続台数が以下の台数の場合は、伝送線用給電拡張ユニット（別売）が必要となります。

	伝送線用給電拡張ユニット（別売）必要台数		制限台数（N）
	1台	2台	
接続される室内ユニットが2.2.4形未満の場合	2.1 - 4.0台	4.1 - 4.2台	2.0台
接続される室内ユニットに2.2.4形以上が含まれる場合	1.7 - 3.2台	3.3 - 4.2台	1.6台

注9 伝送線用給電拡張ユニット接続時は、システムユニットから伝送線用給電拡張ユニットまでの室内ユニット台数Nと伝送線用給電拡張ユニット以降の室内ユニット台数Nを上記8項の制限台数以内としてください。（伝送線用給電拡張ユニットを接続する場合は、伝送線のシールドを必ず伝送線用給電拡張ユニットの端子S（シールド）へ接続してください。）  
 注10 ( )内は、コン/クトリモコンの配線径です。  
 注11 電源配線の分岐にはプルボックスを用いてください。（ユニットの電源端子台を用いた渡り配線は行わないでください。）

## 5. 試運転

### (1) 試運転前の確認事項

1	冷媒漏れ、電源、伝送線のゆるみがないか確認します。
2	電源端子台と大地間を500Vメガーで計って、1.0M 以上あるか確認します。 (注1) 絶縁抵抗が、1.0M 以下の場合は運転しないでください。 (注2) 伝送線用端子台にはメグチェックは絶対にかけないでください。制御基板が破損します。 (注3) 据付け直後、もしくは元電源を切った状態で長時間放置した場合には、圧縮機内に冷媒が溜ることにより、電源端子台と大地間の絶縁抵抗が1M 近くまで低下することがあります。 (注4) 絶縁抵抗が1M 以上ある場合は、元電源を入れてクランクケースヒーターを12時間以上通電することにより、圧縮機内の冷媒が蒸発しますので絶縁抵抗は上昇します。
3	ガス側、液側のストップバルブ共、全開になっているか確認します。(P674~P840SM形の場合、ガス側、液側のストップバルブ共、全開になっているか確認します。(注1) キャップは必ず締めてください。
4	三相電源の相順と各相間電圧を確認してください。 (注1) 欠相又は逆相の場合は、試運転時異常停止(4102エラー又は4103エラー)となります。
5	[伝送線用給電拡張ユニットを接続している場合] 室外ユニットの電源を投入する前に、伝送線用給電拡張ユニットの電源を投入してください。 (注1) 室外ユニットの電源を先に投入した場合、冷媒系の接続情報が正常に認識できない場合があります。 (注2) 室外ユニットの電源を先に投入した場合、伝送線用給電拡張ユニットの電源を投入後に室外ユニットの電源をリセットを行ってください。
6	試運転の最低12時間以上前に元電源を入れて、クランクケースヒーターに通電します。 (注1) 通電時間が短いと圧縮機故障の原因となります。

### (2) 試運転方法

イラストは、MAスムースリモコンを示します。

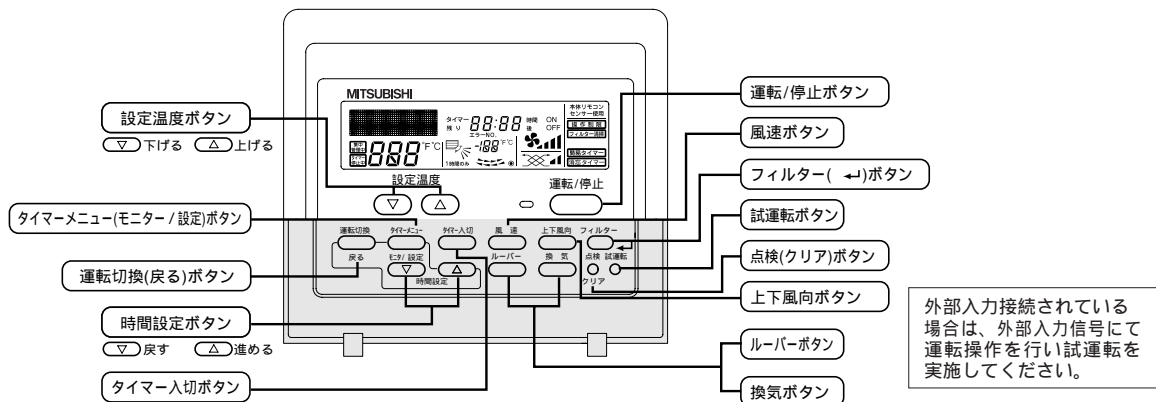

- ・リモコンに点検コードが表示されたり、正常に作動しない場合は、次頁以降を参照してください。
- ・試運転は2時間の切タイマーが作動し、2時間後自動的に停止します。
- ・試運転中、時刻表示部には試運転残時間を表示します。
- ・試運転中、室内ユニットの液管温度をリモコン室温表示部に表示します。
- ・風向調節ボタンを押した時、機種により“無効ボタン”の表示がリモコンに表示されますが、故障ではありません。

### 操作手順

1) 12時間以上前に、元電源を入れる。電源投入後、リモコンに“PLEASE WAIT”が約3分間表示されます。
2) <b>試運転</b> ボタンを2度押す。→“試ウンテン”と設定されている運転モードを交互に表示
3) <b>運転切換</b> ボタンを押して冷房(または暖房)運転に切換える。→冷風(または温風)が吹出すことを確認
4) <b>風速</b> ボタンを押す。→風速が切換わることを確認
5) <b>上下風向</b> または <b>ルーバー</b> ボタンを押して風向を切換える。→水平吹き、下吹き等、風向調節が可能か確認
6) 室外ユニットファンの運転を確認
7) <b>運転/停止</b> ボタンを押して試運転解除する。→停止
8) リモコンへ異常時の連絡先設定で電話番号登録を行ってください。 MAスムースリモコン、MAデラックスリモコンでは、異常時の連絡先(工事店または販売店)の電話番号をリモコンへ登録することができます。登録された電話番号はエラー発生時にリモコンへ表示されるようになります。登録操作の方法は、リモコンに付属の据付工事説明書を参照してください。

### (3) 試運転時の不具合対応

異常停止時、リモコン表示部に4桁の点検表示が表れますので、不具合要因の点検をお願いいたします。

#### 室外ユニット

点検表示	不具合内容	点検表示	不具合内容
0403	シリアル通信異常	5108	サブクールコイルバイパス出口温度センサー異常(TH8)
1102	吐出温度異常	5110	インバーター放熱板温度センサー異常(THHS)
1301	低圧圧力異常	5111	ファンコントローラー放熱板温度異常(THBOX)
1302	高圧圧力異常	5114	圧縮機シェル温度センサー異常(TH10) 1
1500	冷媒過充てん	5201	高圧圧力センサー異常
4102	欠相異常	5301	DC / AC センサー回路異常
4103	逆相 / 欠相異常	6600	ユニットアドレス二重設定
4108	過負荷保護 (No.2Comp過電流)	6602	送信エラー (伝送プロセッサハードウェア異常)
4115	電源同期信号異常	6603	送信エラー (伝送路BUSY)
4121	高調波対策機器異常	6606	送受信エラー (伝送プロセッサとの通信異常)
4200	インバーター異常	6607	送受信エラー (ACK無しエラー)
4220	インバーター母線電圧異常	6608	送受信エラー (応答フレーム無しエラー)
4230	インバーター放熱板過昇保護	7100	合計能力エラー
4240	インバーター過負荷保護	7101	能力コードエラー
4250	PM異常一括/過電流異常	7102	接続台数エラー
4260	冷却ファン異常	7105	アドレス設定エラー
5101	吐出温度センサー異常 (TH11,TH12)	7109	接続設定エラー
5102	熱交換器ガス管温度センサー異常(TH2) 2	7110	接続情報未設定エラー
5105	配管温度センサー異常 (TH5)	7113	機能設定エラー
5106	外気温度センサー異常 (TH6)	7130	組合せ異常
5107	サブクールコイル液出口センサー異常 (TH7)		

1.P780・P840・P900SM-Eのみ

2.P960～P1400SKM-Eのみ

#### 室内ユニット

点検表示	不具合内容	点検表示	不具合内容
2500	漏水異常	6606	送受信エラー (伝送プロセッサとの通信異常)
2502	ドレンポンプ異常	6607	送受信エラー (ACK無しエラー)
2503	ドレンセンサー異常・フロートスイッチ作動	6608	送受信エラー (応答フレーム無しエラー)
5101	吸込センサー異常	6831	MA通信受信異常 (受信なし)
5102	配管センサー異常	6832	MA通信受信異常 (同期回復異常)
5103	ガス側配管センサー異常	6833	MA通信受信異常 (H/W異常)
6600	ユニットアドレス二重設定	6834	MA通信受信異常 (スタートビット検出異常)
6602	送信エラー (伝送プロセッサハードウェア異常)	7101	能力コードエラー
6603	送信エラー (伝送路BUSY)	7111	リモコンセンサー異常

#### 業務用ロスナイ (加熱・加湿付)

点検表示	不具合内容	点検表示	不具合内容
0900	試運転 (異常ではありません)	6606	送受信エラー (伝送プロセッサとの通信異常)
2503	ドレンセンサー異常・フロートスイッチ作動	6607	送受信エラー (ACK無しエラー)
2600	漏水異常	6608	送受信エラー (応答フレーム無しエラー)
2601	加湿器断水異常	6831	MA通信受信異常 (受信なし)
5101	吸込センサー異常	6832	MA通信受信異常 (同期回復異常)
5102	配管センサー異常	6833	MA通信受信異常 (H/W異常)
5103	ガス側配管センサー異常	6834	MA通信受信異常 (スタートビット検出異常)
5104	リターン温度センサー異常	7101	能力コードエラー
6600	ユニットアドレス二重設定	7106	属性設定エラー
6602	送信エラー (伝送プロセッサハードウェア異常)	7111	リモコンセンサー異常
6603	送信エラー (伝送路BUSY)		

## 手元リモコン

### a . M-NETリモコン

点検表示	不具合内容	点検表示	不具合内容
6600	ユニットアドレス二重設定	6606	送受信エラー( 伝送プロセッサとの通信異常 )
6602	送信エラー( 伝送プロセッサハードウェア異常 )	6607	送受信エラー( ACK無しエラー )
6603	送信エラー( 伝送路BUSY )	6608	送受信エラー( 応答フレーム無しエラー )

### b . MAリモコン

点検表示	不具合内容	点検表示	不具合内容
6201(E1)	リモコンH/W異常( EEPROM )	6202(E2)	リモコンH/W異常( RTC )
6831	MA通信受信異常( 受信なし )	6833	MA通信送信異常( H/W異常 )
6832	MA通信受信異常( 同期回復異常 )	6834	MA通信送信異常( スタートビット検出異常 )

## システムコントローラー

点検表示	不具合内容	点検表示	不具合内容
6600	ユニットアドレス二重設定	6607	送信エラー( ACK無しエラー )
6602	送信エラー( 伝送線プロセッサハードウェア異常 )	6608	送受信エラー( 応答フレーム無しエラー )
6603	送信エラー( 伝送路BUSY )	7106	属性設定エラー
6606	送受信エラー( 伝送プロセッサとの通信異常 )		

#### (4) リモコンの動作不具合内容と処置

##### MAリモコンシステムの場合

不具合現象または点検コード	要 因	チェック方法と処理
リモコンに運転表示されるが、一部の室内ユニットが動作しない	<ul style="list-style-type: none"> <li>・室内ユニットの電源が入っていない</li> <li>・同一グループ内の室内ユニット間の配線忘れ</li> <li>・スリム機種と同一グループ接続されている</li> <li>・室内ユニット制御基板のヒューズ切れ</li> </ul>	<p>異常発生が以下のうちどれかを確認する。</p> <p>システム全体 冷媒系統内全て 同一グループ内のみ 一台の室内ユニットのみ</p>
室内ユニット運転してもすぐリモコンが消える	<ul style="list-style-type: none"> <li>・室内ユニット（親機）の電源が入っていない</li> <li>・システムコントローラーとのグルーピング一致していない</li> <li>・室内ユニット（親機）制御基板のヒューズ切れ</li> <li>・分流コントローラーの電源が入っていない</li> </ul>	<p>&lt;システム全体の場合および冷媒系統内全ての場合&gt;</p> <ul style="list-style-type: none"> <li>・室外ユニットの自己診断LEDを確認する</li> <li>・左記項目のうち室外ユニットの関連している項目を確認する</li> </ul>
ロスナイとの連動登録が正常にできない	<ul style="list-style-type: none"> <li>・ロスナイの電源が入っていない</li> <li>・異冷媒のロスナイで異冷媒の室外ユニットの電源が入っていない</li> <li>・室内ユニットに既にロスナイ（1台）登録されている</li> <li>・ロスナイのアドレスが異なっている</li> <li>・ロスナイのアドレスを設定していない</li> <li>・ロスナイが伝送線に接続されていない</li> </ul>	<p>&lt;同一グループ内のみおよび一台の室内ユニットのみ場合&gt;</p> <ul style="list-style-type: none"> <li>・左記項目のうち室内ユニットの関連している項目を確認する</li> </ul>
リモコンに通電表示（●）されていない （MAリモコン給電なし）	<p>室内ユニットは、室内外の立上げが正常に完了するまでリモコン給電されません。</p> <ul style="list-style-type: none"> <li>・室内ユニットの電源が入っていない</li> <li>・室外ユニットの電源が入っていない</li> <li>・リモコン接続台数（2台）オーバー又は、室内接続台数（16台）オーバー</li> <li>・室内ユニットのアドレスが“00”で、室外ユニットのアドレスが“00”以外となっている</li> <li>・室内外伝送線がTB7に接続されている</li> <li>・室内外伝送線にMAリモコンが接続されている</li> <li>・リモコン線のショート/断線</li> <li>・電源配線又は伝送線のショート/断線</li> <li>・室内ユニット制御基板のヒューズ切れ</li> </ul>	
リモコンの“PLEASE WAIT”（HO）が消えない 又は、“PLEASE WAIT”（HO）を周期的に繰り返す （室外ユニットの電源投入後通常最大3分“PLEASE WAIT”（HO）表示されます）	<ul style="list-style-type: none"> <li>・室外ユニットの電源が入っていない</li> <li>・伝送線用給電拡張ユニットの電源が入っていない</li> <li>・MAリモコン主従切替を従にしている</li> <li>・室内外伝送線にMAリモコンが接続されている</li> <li>・室外補助ユニットの伝送線ショート/断線</li> </ul>	
リモコンに通電表示（●）が表示されているが運転しない	<ul style="list-style-type: none"> <li>・室内ユニット（親機）の電源が入っていない</li> <li>・室内外伝送線がTB7に接続されている</li> <li>・室内外伝送線ショート又は断線・接触不良</li> <li>・室内ユニット（親機）制御基板のヒューズ切れ</li> </ul>	



M-NETリモコンシステムの場合

不具合現象または点検コード	要 因	チェック方法と処理
リモコンに運転表示されるが、一部の室内ユニットが動作しない	<ul style="list-style-type: none"> <li>・室内ユニットの電源が入っていない</li> <li>・同一グループ内の室内ユニット又はリモコンのアドレスミス</li> <li>・異冷媒のグルーピングでリモコンで初期登録していない</li> <li>・室内ユニット制御基板のヒューズ切れ</li> </ul>	<p>異常発生が以下のうちどれかを確認する。</p> <p>システム全体 冷媒系統内全て 同一グループ内のみ 一台の室内ユニットのみ</p>
室内ユニット運転してもすぐリモコンが消える	<ul style="list-style-type: none"> <li>・室内ユニットの電源が入っていない</li> <li>・室内ユニット制御基板のヒューズ切れ</li> </ul>	<p>&lt;システム全体の場合および冷媒系統内全ての場合&gt;</p> <ul style="list-style-type: none"> <li>・室外ユニットの自己診断LEDを確認する</li> <li>・左記項目のうち室外ユニットの関連している項目を確認する</li> </ul>
ロスナイとの連動登録が正常にできない	<ul style="list-style-type: none"> <li>・ロスナイの電源が入っていない</li> <li>・異冷媒のロスナイで異冷媒の室外ユニットの電源が入っていない</li> <li>・室内ユニットに既にロスナイ（1台）登録されている</li> <li>・ロスナイのアドレスが異なっている</li> <li>・ロスナイのアドレスを設定していない</li> <li>・ロスナイが伝送線に接続されていない</li> </ul>	<p>&lt;同一グループ内のみおよび一台の室内ユニットのみ場合&gt;</p> <ul style="list-style-type: none"> <li>・左記項目のうち室内ユニットの関連している項目を確認する</li> </ul>
リモコンに通電表示（●）されていない （M-NETリモコン給電なし）	<ul style="list-style-type: none"> <li>・室外ユニットの電源が入っていない</li> <li>・冷媒系統内の室内ユニット又はリモコンの接続台数オーバー</li> <li>・MAリモコン線にM-NETリモコン接続</li> <li>・室内外伝送線のショート/断線</li> <li>・M-NETリモコン線のショート/断線</li> </ul>	
リモコンの“PLEASE WAIT”（HO）が消えない 又は、“PLEASE WAIT”（HO）を周期的に繰返す （室外ユニットの電源投入後通常最大3分“PLEASE WAIT”（HO）表示されます）	<ul style="list-style-type: none"> <li>・伝送線用給電拡張ユニットの電源が入っていない</li> <li>・室外ユニット“00”のままとなっている</li> <li>・室内ユニット又はリモコンのアドレス設定ミス</li> <li>・室内外伝送線にMAリモコンが接続されている</li> <li>・室外補助ユニットの伝送線ショート/断線</li> </ul>	
リモコンに通電表示（●）が表示されているが運転しない	<ul style="list-style-type: none"> <li>・室内外伝送線がTB7に接続されている</li> <li>・室内外伝送線ショート又は断線・接触不良</li> </ul>	

(5) 次の現象は故障（異常）ではありません

現象	リモコン表示	原因
冷（暖）房運転しても室内ユニットが運転しない。	“冷（暖）房” 点滅表示	他の室内ユニットが暖（冷）房運転をしている場合、冷（暖）房運転はできません。
オートベーンが勝手に動く。	通常表示	オートベーンの制御動作により、冷房時、下吹きで使用した場合、1時間経過すると自動的に水平吹出しになることがあります。暖房時の霜取時、ホットアジャスト時、およびサーモ“OFF”時は、自動的に水平吹出しとなります。
暖房運転中風速設定が切替わる。	通常表示	サーモ“OFF”時は微風運転となります。 サーモ“ON”時、時間または配管温度により、微風設定値へ自動的に切替わります。
暖房運転中ファンが停止する。	霜取中	霜取運転中はファンが停止します。
運転停止してもファンが停止しない。	消灯	補助電気ヒーター“ON”時は、停止後1分間余熱排除としてファンを運転します。
運転SW“ON”しても風速が設定値にならない。	暖房準備中	SW“ON”後5分間、又は配管温度35℃迄微風、その後2分間弱風の後、設定値になります。 (ホットアジャスト制御)
運転しても室外ユニットが運転しない。	通常表示	室外ユニットが冷込んで冷媒が寝込んでいる場合は、最長35分間、圧縮機を暖めるウォーミングアップ運転を行います。(P140,P160,P224形のみ)この間は送風運転となります。
元電源をONしたとき約3分間室内ユニットリモコンに右のような表示をする。	“PLEASE WAIT”(HO) 点滅表示	システムの立上げをしています。 “PLEASE WAIT”(HO)の点滅表示が消えた後にリモコンの操作をしてください。
運転停止してもドレンポンプが停止しない。	消灯	冷房運転停止時は、停止後、3分間ドレンポンプを運転してから停止します。
停止中でもドレンポンプが運転する。		停止中でもドレン水が発生した場合は、ドレンポンプを運転します。
冷暖房切替時に室内ユニットおよび分流コントローラーから音が出る場合がある。	通常表示	冷媒回路の切替音ですので異常ではありません。
運転直後に室内ユニットから冷媒流動音が出る場合がある。	通常表示	過渡的な冷媒流動の不安定によるものですので異常ではありません。
暖房運転以外の室内ユニットから温風が出る場合がある。	通常表示	暖房運転以外の室内ユニットへの冷媒寝込み防止を目的にLEVを微開にしているためで異常ではありません。万一不具合となる場合には、「5. 機器選定時の注意事項」に従って対応してください。