

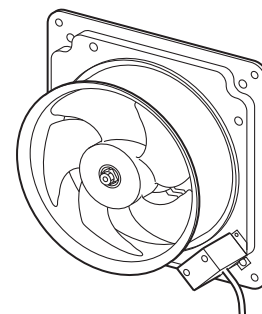

Pressurized ventilators (for device cooling)

Model	Blade diameter (cm)	Indoor or outdoor
EF-20UYS-UL	20	Indoor
EF-25UAS-UL	25	
EF-30UBS-UL	30	



Installation/Instruction Manual

For customers

Please read this manual carefully before use for proper and safe use.

After reading, store the manual in a handy location for easy access.

For contractors

Be sure to read this manual before starting installation work to ensure correct and safe installation. Dealers and electrical contractors shall perform installation in accordance with the standards of each country.

Notify the customers to observe Safety Precautions which describe important safety instructions.

■ This fan is a single-phase product.

Check the type of power supply before performing the installation work.

■ This fan is for exhaust use only.

Blades cannot be replaced and wire connections cannot be changed.

Contents

Explanation of installation work (For contractors)

1. Safety Precautions	2
2. Usage and Usage Environment	3
3. Precautions before Installation	3
4. Name of the Parts	4
5. Outside Dimensions	5
6. Installation Procedure	6
7. Electrical Work	7
8. Check after installation	7
9. Trial Operation	7

Handling Explanation (For customers)

1. Safety Precautions	8
2. How to Use the Fan	9
3. Cleaning	9
4. Maintenance and Inspection	10
5. Before Requesting Repair	11
6. After-Sales Service	12
7. Specifications	12





After completing installation, be sure to give this manual to the customer.





Explanation of installation work

For contractors

1. Safety Precautions

The type and degree of danger resulting from incorrect handling are denoted by the following symbols.

 WARNING		Incorrect handling could result in death or serious injury		
 Prohibited	Do not install the fan in a place where explosive dust or gas is generated or could be generated. - Failure to heed this warning may result in explosion or fire.	 Follow instructions	When using the fan to exhaust air from a room where a combustion appliance for exhausting air through a chimney is installed, install an air supply opening large enough to prevent flowing of exhaust air back into the room. - Failure to heed this warning may result in carbon monoxide poisoning.	
	Do not use the fan at other than the rated voltage and frequency. - Failure to heed this warning may result in fire or electric shock.			Install the fan in such a way that a wood structure covered with metal lath, wire lath, or metal sheeting and the metal body part do not directly contact each other. - It could cause fire when electrical leakage occurs.
	Do not use the fan for purposes other than ventilation and blowing air. - Failure to heed this warning may result in fire, electric shock or injury.			
 Check grounding	Be sure to install the ground wire. - Device failure and electric leakage may cause electric shock.			Be sure to install the electric leakage breaker. - Electric leakage may cause electric shock.
 Follow instructions	Since this product is designed to be installed at a higher location, install the product at least 2.3 m above the floor. - Failure to heed this warning may result in injury.			Be sure to turn off the distribution panel circuit breaker before proceeding with maintenance and inspection. - Failure to heed this warning may result in electric shock or injury.

 CAUTION		Incorrect handling could result in injury or property damage to buildings and machinery		
 Prohibited	Do not install the fan in a place where it could be exposed to flame directly. - Failure to heed this warning may result in fire.	 Follow instructions	Electrical work must be performed according to the standards of each country. Never perform connection by hand-twisting wires. Furthermore, power lines must be connected inside a box and box cover for rigid metal conduit. - Connection failure and faulty wiring work could result in electric shock or fire.	
 Cannot be installed in a bathroom	Do not install the fan in a location with high humidity such as a bathroom (relative humidity 90% or higher). - Failure to heed this warning may result in electric shock or fire.			Wear gloves before proceeding with unpacking, installation, maintenance/inspection and cleaning. - Failure to heed this warning may result in injury caused by, for example, the edge of the plate.
 Follow instructions	Securely install the fan on a solid, vibration-free location. - Injury may result if the fan should fall.			
	Securely install blades and parts. - Injury could result if parts fall.			
Electrical contractors shall perform electrical work and grounding work. - Electrical work by a person other than a qualified electrician could result in electric shock or fire.				

2. Usage and Usage Environment

Environment and restriction condition

Protection Rating	IPXX
Class of protection	Class I
Over voltage category	Class II
Pollution degree	Class II
Permissible Temp. in use	- 15°C to 50°C (The unit must not be frozen.)
Permissible Humidity in use	90% at 20°C
Permissible Altitude in use	1000 m or less
Installation condition	High place installation (2.3 m or higher from the floor) Indoor installation

3. Precautions before Installation

- The fan must have a structure that allows easy maintenance and always consider a fail-safe design if secondary damage can be assumed when the end of the service life of the fan is reached or in case of a failure.
- Install the fan so that the motor shaft is placed either horizontally (the capacitor box is placed at the bottom right) or vertically.
- Because this product is designed to be installed in higher locations, install the fan at least 2.3 m above the floor. To prevent danger, do not install the fan in a location where people can easily touch it.
- The size of the air supply opening must be more than 1.5 times the size of the diameter of the blade.
- When this fan is used for a cubicle, it should meet the standards of each country.
- This fan is dedicated for exhaust use only. The fan cannot be used for air supply by changing the blade direction.
- When installing in proximity, depending on the installation conditions, vibration or noise may occur in the fan or the motor burning protection device may be activated.
- The fan cannot operate by using inverters.
- Do not apply external force to the blade when carrying the fan.

■ Do not install in the following locations (doing so could cause failure)

- Locations having a blocking object at the suction side or extreme bending in air ducts, as shown in the figure on the right (Draft currents may occur, which could damage the blades)
- Locations where the temperature could be over 50 °C
- Locations with obstacles
- Locations where the temperature could be under -15 °C
- Locations subject to salt damage
- Locations where there is a possibility of freezing such as freezing chambers
- Locations where the temperature may be under 0 °C constantly
- Locations where corrosive gas may be present or chemicals are handled
- Locations subject to extremely high static pressure
- Locations where large amounts of dust or oily smoke is present
- Locations where the fan is directly exposed to oil smoke or steam

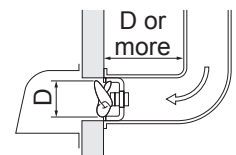

※D: blade diameter

(Install an air intake port, which has a size equivalent to or larger than the mounting frame of the fan.)

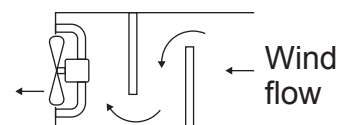

4. Name of the Parts

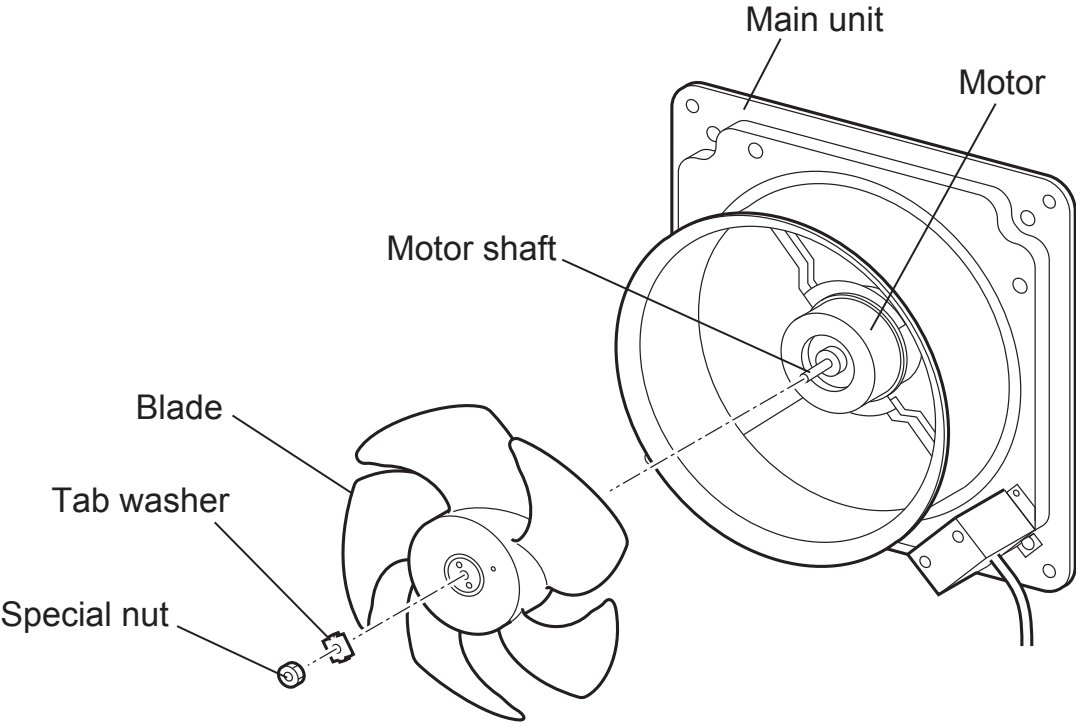

5. Outside Dimensions

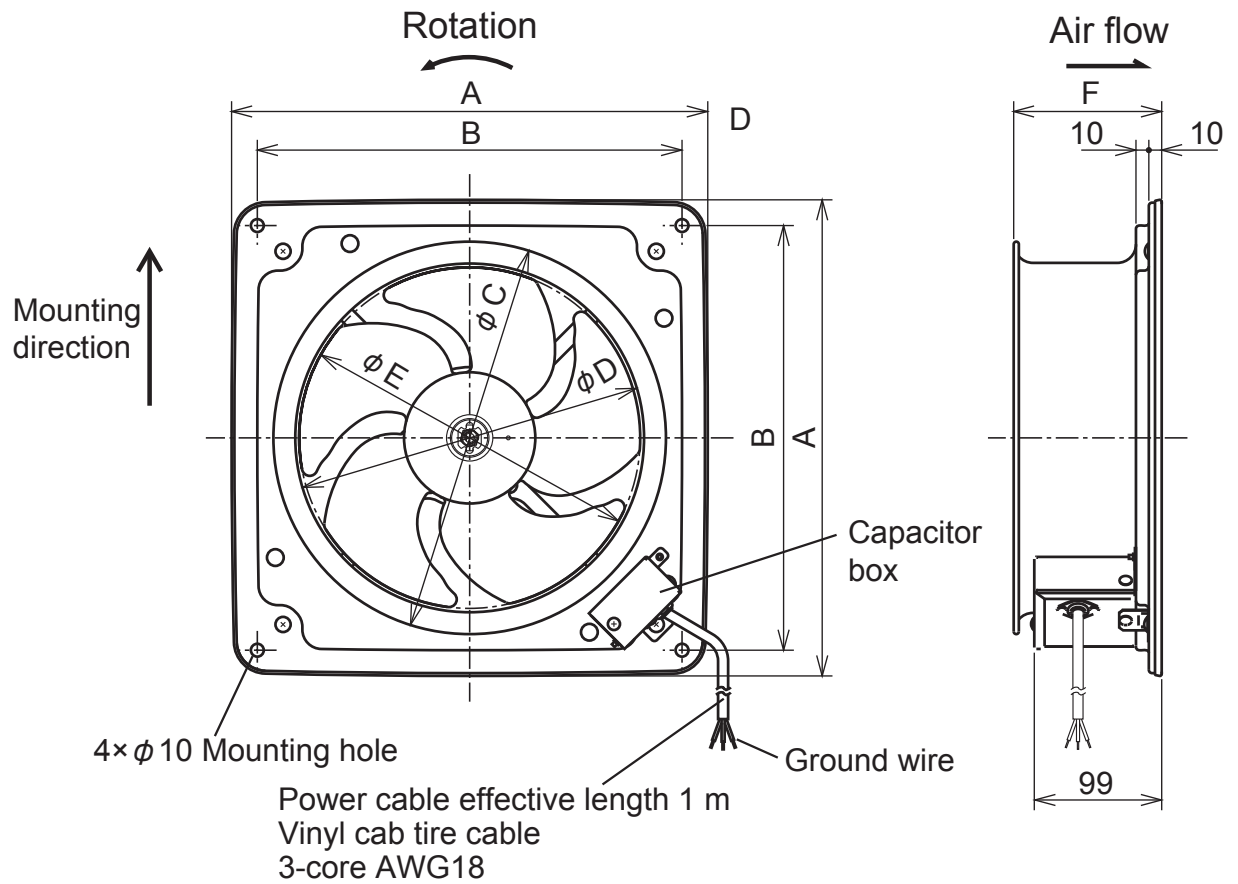

*When the motor shaft is placed horizontally, install the fan so that the mounting-direction arrow is placed up.

Unit (mm)

Model	A	B	C	D	E	F
EF-20UYS-UL	320	280	260	228	220	105
EF-25UAS-UL	370	330	305	271	265	115
EF-30UBS-UL	420	380	340	306	300	125

6. Installation Procedure

⚠️ WARNING

Since this fan is designed to be installed in a higher location, install the fan at least 2.3 m above the floor.

- Failure to heed this warning may result in injury.

⚠️ CAUTION

Wear gloves when unpacking or installing.

- Failure to heed this warning may result in injury caused by, for example, the edge of the plate.

Securely install the fan on a solid, vibration-free place.

- Injury may result if the fan should fall.

When unclean air is discharged, a place where fresh air enters is required.

Install an air intake port, which has a size equivalent to or larger than the mounting frame of the fan, at the opposite side to the fan installed side of the room.

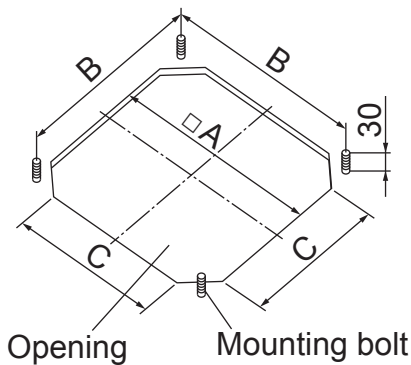

Unit (mm)

Type	A	B	C	Mounting bolt diameter
20 cm	290	280	240	M8
25 cm	340	330	290	M8
30 cm	390	380	340	M8

1. Provide an opening and mount the mounting bolts in the locations indicated on the figure on the left.

2. Mount the fan.

Put the mounting bolts through the mounting holes and then use washers and nuts to secure them properly.

Note:

- Do not use the knock out holes for product mounting. (Product vibration, drop/deformation cause)
- Check that the blade does not contact the structure around the main unit.
- Install the fan on a flat surface to avoid deforming the fan.

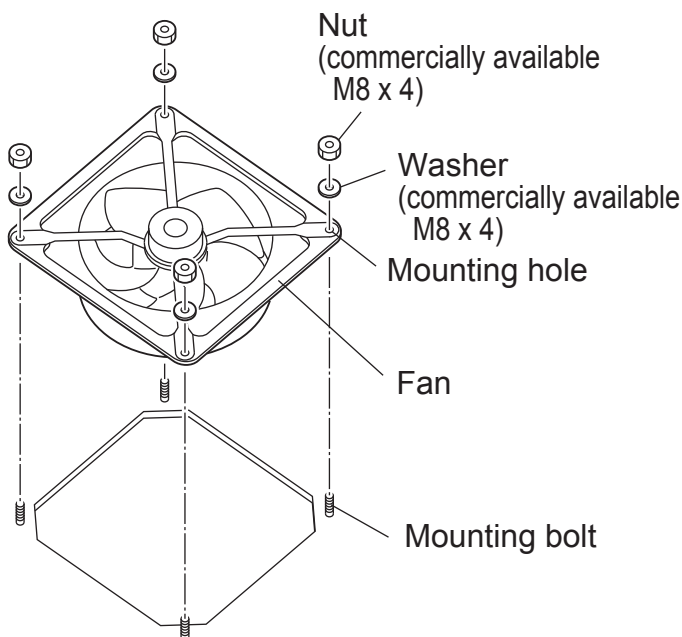

7. Electrical Work



WARNING

Do not use the fan at other than the rated voltage and frequency.

- Failure to heed this warning may result in fire or electric shock.

Be sure to install the ground wire.

- Device failure and electric leakage may cause electric shock.



CAUTION

Electrical work must be performed according to the standards of each country. Never perform connection by hand-twisting wires. Furthermore, power lines must be connected inside a box and box cover for rigid metal conduit.

- Connection failure and faulty wiring work could result in electric shock or fire.

■ Connection Diagram

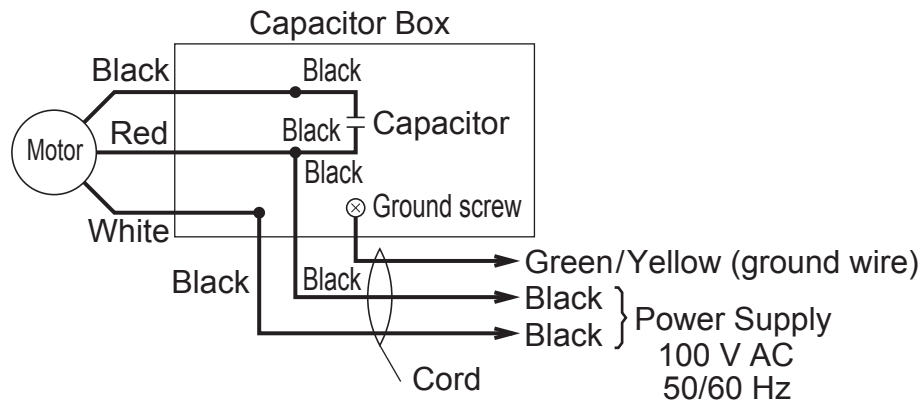

- Power supply is 100 V AC (single-phase). Perform connection after checking that the power supply is correct. If the fan is operated with the wrong power supply, the motor could burn out.
- Be sure to install an electric leakage breaker.
- Always ground the grounding terminal.
- To protect against overload on the motor, use overload protection equipment that employs a magnetic switch (magnetic contact + thermal relay). Overload protection equipment must be attached for every unit. The setting current value of the magnetic switch is taken 1.2 times maximum load current given in Page 12 "Specifications" as reference.

8. Check after installation

When completing installation, check the fan according to Section 6 and 7.

Be sure to correct any problems that are found. (Failure to correct the problems may result in poor performance, and furthermore safety cannot be ensured.)

9. Trial Operation

After installation work, check the following items.

1. Is the fan installed correctly?
2. Is not the power cord damaged?
3. Has grounding work been performed correctly?
4. Is the power supply voltage correct?

Turn ON the breaker to perform trial operation.







5. Is not there abnormal vibration or noise?



Handling Explanation

(For customers)

1. Safety Precautions

The type and degree of danger resulting from incorrect handling are denoted by the following symbols.

 WARNING		Incorrect handling could result in death or serious injury
 No water exposure	Refrain from immersing in water or splashing the product with water. - Failure to heed this warning could result in short circuit, electric shock or fire.	
 No disassembly	Never make modification under any circumstances. Only qualified personnel can perform disassembly and repair. - Failure to heed this warning may result in fire, electric shock or injury. For repair, contact the dealer from whom you purchased the fan.	
 Touching prohibited	Do not insert fingers or objects into the fan during operation as doing so is dangerous. - Failure to heed this warning may result in injury.	
	Never touch the fan when it is stopped with the power on, when there is an abnormality (for example, if you smell burning), or when there is a power outage. - It may start suddenly, resulting in injury or electric shock.	
 No wet hands	Do not operate with wet hands. - Failure to heed this warning may result in electric shock or injury.	
 Follow instructions	Turn off the distribution board circuit breaker before proceeding with cleaning, maintenance, and inspection. - Failure to heed this warning may result in electric shock or injury.	

 CAUTION		Incorrect handling could result in injury or property damage to buildings and machinery
 Prohibited	Do not use the fan when it is subject to abnormal vibration. - Injury may result if the fan or parts should fall.	
	Do not use the fan in such a way that it is started and stopped more than 50 times a day. - Injury could result if parts are damaged or fall.	
 Follow instructions	If the fan will not be operated for a long time, be sure to turn off the circuit breaker on the power distribution panel. - Failure to heed this warning may result in electric shock due to deteriorated insulation or fire due to electric leakage.	
	When the blades are stained badly, make sure to clean them. - Injury could result if parts are damaged or fall due to vibration.	
	Be sure to wear gloves during cleaning, maintenance and inspection. - Failure to heed this warning may result in injury caused by, for example, the edge of the plate.	

Installation work is carried out in accordance with the regulations of each country. After completing installation, check Trial Operation.

2. How to Use the Fan

To operate ... Turn ON the breaker.

To stop ... Turn OFF the breaker.



WARNING

Do not insert fingers or objects into the fan during operation as doing so is dangerous.

- Failure to heed this warning may result in injury.

Do not operate with wet hands.

- Failure to heed this warning may result in electric shock or injury.

3. Cleaning



WARNING

Be sure to turn off the distribution panel circuit breaker before cleaning.

- Failure to heed this warning may result in electric shock or injury.



CAUTION

Wear gloves during cleaning.

- Failure to heed this warning may result in injury caused by, for example, the edge of the plate.

Cleaning of blades, etc.

Cleaning should be performed about every three months.

- Wipe with a piece of cloth soaked in neutral detergent, and then wipe with a dry cloth so as not to leave any detergent behind.

Overall cleaning

- If flammable material such as oil or dust adheres to the fan, the material could catch fire due to flying sparks.

Always perform periodic cleaning (about once a year).

Note:

- Do not use the following solvents when cleaning:

Paint thinner, alcohol, benzene, gasoline, kerosene, spray solvents, alkaline detergents, chemicals from wipes, or detergents containing abrasives such as cleansers, or the like. (Using such solvents could cause materials to become altered or discolored.)

4. Maintenance and Inspection



WARNING

Be sure to turn OFF the distribution panel circuit breaker before proceeding with maintenance and inspection.

- Failure to heed this warning may result in electric shock or injury.



CAUTION

Be sure to wear gloves during maintenance and inspection.

- Failure to heed this warning may result in injury caused by, for example, the edge of the plate.

When cleaning once every three months, inspect the following items:

Item	Inspection content	Action
Rust	Is there rust on the fan itself or the nuts or bolts used to mount the product rusted?	Use urethane paint to address partial rusting. If there is rust on a significant portion of a part, replace the part. (Injury could result if the fan falls.)
	Is there rust on the blade fix nuts or the blades?	Use urethane paint to address partial rusting. If there is rust on a significant portion of a part, the part must be replaced. Ask your dealer or an electrical contractor to repair the unit. (Injury could result if the blades are damaged or the fan falls.)
Wobbling	Are the nuts used to mount the fan loose? Are the blades and motor properly secured?	Tighten the nuts so that the fan does not wobble. (Injury may result if the fan or blades fall.)
Damage	Does the motor appear to be discolored?	The motor needs to be replaced. Ask your dealer or an electrical contractor to repair the fan.
	Is the power cable damaged?	The motor needs to be replaced. Ask your dealer or an electrical contractor to repair the fan.
	Are there cracks on the blades?	The blades need to be replaced. Ask your dealer or an electrical contractor to repair the fan. (Injury could result if the blades are damaged or the fan falls.)
Dust	Is there dust on high temperature parts such as the motor? If a filter or insect screen is used, is it clogged?	Perform cleaning.
Abnormal noise	Is there abnormal noise while the fan is turning?	The bearing or motor needs to be replaced. Ask your dealer or an electrical contractor to repair the fan. Note: The service life of the bearing is about 30,000 hours under continuous operation in a 50 °C environment. (The service life may get shorter depending on the operating environment) Inspect and replace if necessary.

5. Before Requesting Repair

After the fan used for a long time for safety, it is recommended that the fan be checked even if the fan has no trouble.

If the following phenomenon is found and cannot be corrected after inspection by the customer, turn off the breaker and ask your dealer or an electrical contractor to inspect and repair the fan. Please ask your dealer or an electrical contractor about the cost of repairs.

Phenomenon	Cause/Action	
The fan does not start even though the power is ON.	The breaker is OFF.	Turn ON the breaker.
There is abnormal sound or vibration during operation.	The blades are loose.	Tighten Special nut.
	The main unit is loose.	Tighten main unit fix nuts.
	There are abnormal sounds from the bearing.	Change the bearing. Ask your dealer or an electrical contractor to repair the fan.
	Rust has occurred over a wide range.	Replace rusted parts. Ask your dealer or an electrical contractor to repair the fan.
There is a burnt smell.	Something is caught on the blades.	Remove the caught object.
	The ambient temperature has exceeded 50 °C.	The fan cannot be used in a location where the ambient temperature exceeds 50 °C. Lower the ambient temperature or use another model.
	There is corrosion inside the motor.	Change the motor. Ask your dealer or an electrical contractor to repair the fan.

Note:

The fan has a built-in thermal fuse for protection against the damage by a fire.

The above overload protection equipment will activate automatically to stop rotation in the case of locked operation, overloading, application of incorrect voltage, or an ambient temperature in excess of the rated level. If this should occur, turn OFF the power and eliminate the cause of the problem.

*If the thermal fuse is blown, the motor must be changed. Switch OFF the power and ask a qualified electrical contractor to change the motor.

6. After-Sales Service

For after-sales service, ask the sales agent from whom you purchased the product.
To change the motor, contact your dealer and tell the fan model name to request repair.

■ Retention period of functional repair parts

We will retain the functional repair parts for nine years after terminating production of the product.
The functional repair part means a part which is necessary to maintain the function of the product.

7. Specifications

Model	Blade diameter (cm)	Frequency (Hz)	Air volume (m ³ /h)	Noise (dB)	Current (A)	Power consumption (W)	Starting current (A)	Maximum load current (A)	Weight (kg)
EF-20UYS-UL	20	50	730	38.5	0.37	36	0.76	0.39	2.5
		60	850	43	0.44	44	0.75	0.48	
EF-25UAS-UL	25	50	1230	41.5	0.45	43	1.18	0.57	3.6
		60	1430	46	0.56	56	1.08	0.70	
EF-30UBS-UL	30	50	1920	46.5	0.81	75	2.26	1.00	4.9
		60	2220	50.5	0.94	94	2.08	1.23	

MITSUBISHI ELECTRIC CORPORATION

Manufactured by: MITSUBISHI ELECTRIC CORPORATION
TOKYO BLDG. 2-7-3, MARUNOUCHI, CHIYODA-KU, TOKYO, 100-8310 JAPAN