

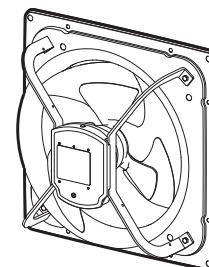

Pressurized ventilators (for device cooling)

	Model	Blade diameter (cm)	Indoor or outdoor
200 V type	EF-35UDT ₂ -GL	35	Indoor
	EF-40UET ₂ -GL	40	
	EF-50UFT ₂ -GL	50	
400 V type	EF-35UDT40A ₂ -GL	35	
	EF-40UET40A ₂ -GL	40	
	EF-50UFT40A ₂ -GL	50	



Installation/Instruction Manual

(For customers)

Please read this manual carefully before use for proper and safe use.

After reading, store the manual in a handy location for easy access.

(For electrical contractors)

Be sure to read this manual before starting installation work to ensure correct and safe installation. Dealers and electrical contractors shall perform installation in accordance with the standards of each country.

Notify the customers to observe Safety Precautions which describe important safety instructions.

■ This fan is a three-phase product.

Check the type of power supply before performing the installation work.

■ This fan is for exhaust use only.

Blades cannot be replaced and wire connections cannot be changed.

Contents

Explanation of installation work (For electrical contractors)

1. Safety Precautions	2
2. Usage and usage environment	3
3. Precautions before Installation	3
4. Outside Dimensions	4
5. Installation Procedure	5
6. Electrical Work	6
7. Check after installation	6
8. Trial Operation	7

Handling Explanation (For customers)

1. Safety Precautions	7
2. How to Use the Fan	8
3. Maintenance	8
4. Maintenance and Inspection	9
5. Before Requesting Repair	10
6. After-Sales Service	11
7. Specifications	11





After completing installation, be sure to give this manual to the customer.





Explanation of installation work

For electrical contractors

1. Safety Precautions

The type and degree of danger resulting from incorrect handling are denoted by the following symbols.

 WARNING		Incorrect handling could result in death or serious injury		
 Prohibited	Do not install the fan in a place where explosive dust or gas is generated or could be generated. - Failure to heed this warning may result in explosion or fire.	 Follow instructions	When using the fan to exhaust air from a room where a combustion appliance for exhausting air through a chimney is installed, install an air supply opening large enough to prevent flowing of exhaust air back into the room. - Failure to heed this warning may result in carbon monoxide poisoning.	
	Do not use the fan at other than the rated voltage and frequency - Failure to heed this warning may result in fire or electric shock.			Install the fan in such a way that a wood structure covered with metal lath, wire lath, or metal sheeting and the metal body part do not directly contact each other. - It could cause fire when electrical leakage occurs.
	Do not use the fan for purposes other than ventilation and blowing air - Failure to heed this warning may result in fire, electric shock or injury.			
 Check grounding	Be sure to install the ground wire. - Device failure and electric leakage may cause electric shock.			Be sure to install the electric leakage breaker - Electric leakage may cause electric shock.
 Follow instructions	Since this product is designed to be installed at a higher location, install the product at least 2.3 m above the floor. - Failure to heed this warning may result in injury.			Be sure to turn off the distribution panel circuit breaker before proceeding with maintenance and inspection. - Failure to heed this warning may result in electric shock or injury.

 CAUTION		Incorrect handling could result in injury or property damage to buildings and machinery		
 Prohibited	Do not install the fan in a place where it could be exposed to flame directly. - Failure to heed this warning may result in fire.	 Follow instructions	Electrical work must be performed according to the standards of each country. Never perform connection by hand-twisting wires. Furthermore, power lines must be connected inside a box and box cover for rigid metal conduit. - Connection failure and faulty wiring work could result in electric shock or fire.	
 Cannot be installed in a bathroom	Do not install the fan in a location with high humidity such as a bathroom (relative humidity 90% or higher). - Failure to heed this warning may result in electric shock or fire.			Wear gloves before proceeding with unpacking, installation, maintenance/inspection and cleaning. - Failure to heed this warning may result in injury caused by, for example, the edge of the plate.
 Follow instructions	Securely install the fan on a solid, vibration-free location. - Injury may result if the fan should fall.			
	Securely install blades and parts. - Injury could result if parts fall.			
	Electrical contractors shall perform electrical work and grounding work. - Electrical work by a person other than a qualified electrician could result in electric shock or fire.			Do not install the fan in a place where there is a possibility of snow accumulation or avalanche. - Injury could result if parts are damaged or fall.

2. Usage and usage environment

Environment and restriction condition

Protection Rating	IPXX
Class of protection	Class I
Over voltage category	Class II
Pollution degree	Class II
Permissible Temp. in use	- 15°C to 50°C (The unit must not be frozen.)
Permissible Humidity in use	90% at 20°C
Permissible Altitude in use	1000m or less
Installation condition	High place installation (2.3m or higher from the floor) Indoor installation

3. Precautions before Installation

- The fan must have a structure that allows easy maintenance and always consider a fail-safe design if secondary damage can be assumed when the end of the service life of the fan is reached or in case of a failure.
- When attaching the fan using an orientation in which the axis vertical blade is facing down (models with a blade diameter of 50 cm), you must move the blade spring in the motor to the opposite side. This procedure should be requested from your dealer.
- Because this product is designed to be installed in higher locations, install the fan at least 2.3 m above the floor. To prevent danger, do not install the fan in a location where people can easily touch it.
- At the opposite side to the fan installed side of the room, install an air intake port, which has a size equivalent to or larger than the mounting frame of the fan.
- When this fan is used for a cubicle, it should meet the standards of each country.
- This fan is dedicated for exhaust use only. The fan cannot be used for air supply by changing the blade direction.
- When installing in proximity, depending on the installation conditions, vibration or noise may occur in the fan or the motor burning protection device may be activated.
- Do not apply external force to the blade when carrying the fan.

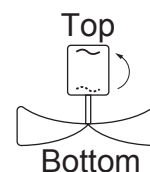

■ Do not install in the following locations (doing so could cause failure)

- Locations having a blocking object at the suction side or extreme bending in air ducts, as shown in the figure on the right (Draft currents may occur, which could damage the blades)
- Locations where the temperature could be over 50 °C
- Locations with obstacles
- Locations where the temperature could be under -15 °C
- Locations subject to salt damage
- Locations where there is a possibility of freezing such as freezing chambers
- Locations where the temperature may be under 0 °C constantly
- Locations where corrosive gas may be present or chemicals are handled
- Locations subject to extremely high static pressure
- Locations where large amounts of dust or oily smoke is present
- Locations where the fan is directly exposed to oil smoke or steam

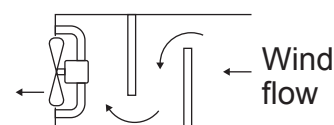

4. Outside Dimensions

EF-35UDT₂-GL, EF-35UDT40A₂-GL

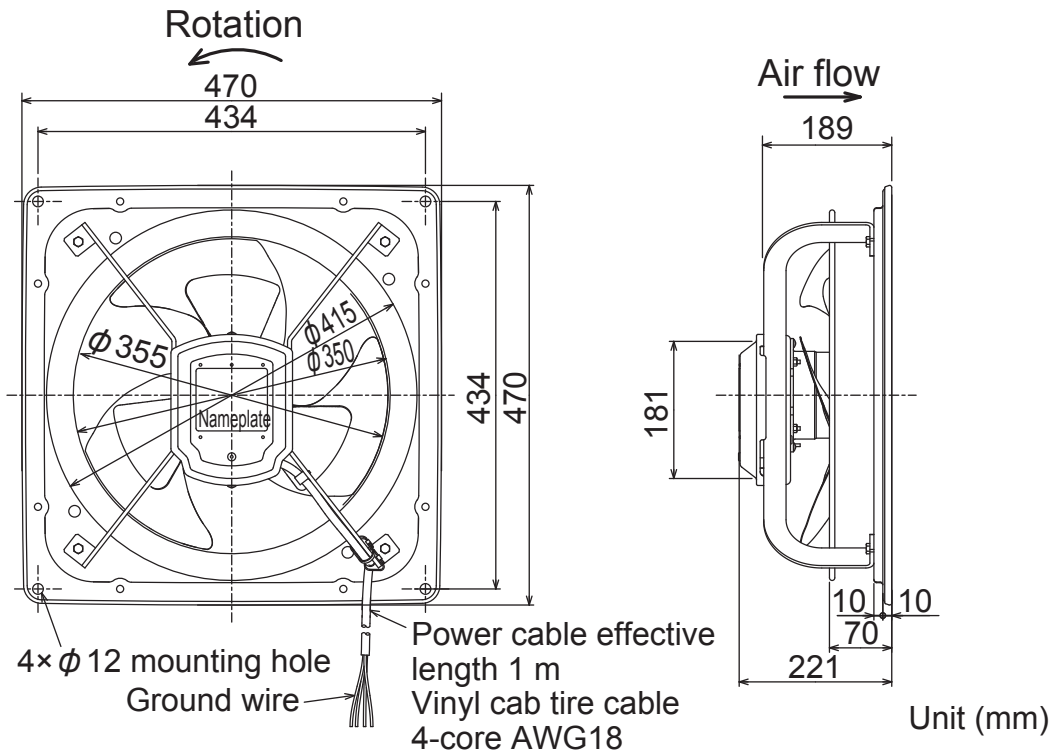

EF-40UET₂-GL, EF-40UET40A₂-GL
EF-50UFT₂-GL, EF-50UFT40A₂-GL

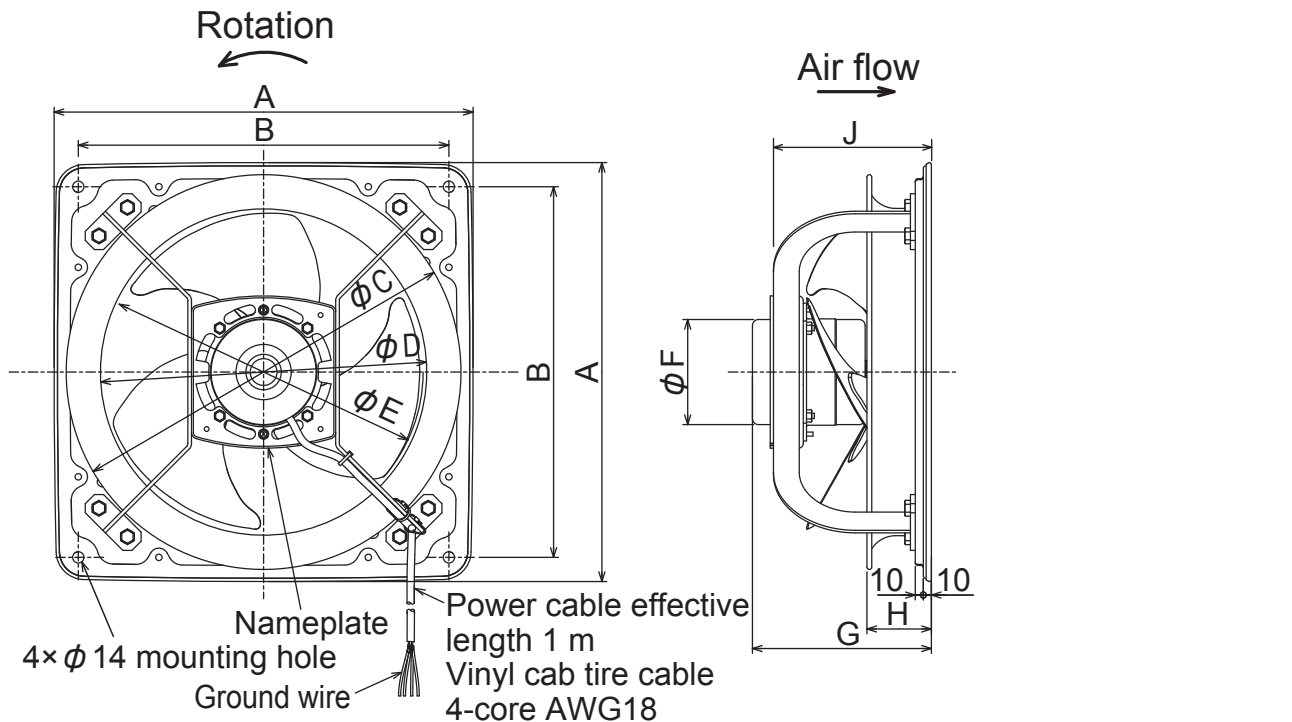

Model	A	B	C	D	E	F	G	H	J
EF-40UET ₂ -GL EF-40UET40A ₂ -GL	520	460	490	405	400	131	222	80	196
EF-50UFT ₂ -GL EF-50UFT40A ₂ -GL	620	560	605	510	500	131	258	95	232

5. Installation Procedure



WARNING

Since this fan is designed to be installed in a higher location, install the fan at least 2.3 m above the floor.

- Failure to heed this warning may result in injury.



CAUTION

Wear gloves when unpacking or installing.

- Failure to heed this warning may result in injury caused by, for example, the edge of the plate.

Securely install the fan on a solid, vibration-free place

- Injury may result if the fan should fall.

When unclean air is discharged, a place where fresh air enters is required.

Install an air intake port, which has a size equivalent to or larger than the mounting frame of the fan, at the opposite side to the fan installed side of the room.

■ Preparation for installation

- Remove the drain cap (drain plug) ... If the fan is used in a location with high humidity

If the fan is used in a location with high humidity, install the fan in such a way that the drain cap (drain plug) provided on the motor and motor cover comes to the bottom. Remove the drain cap (drain plug) on the bottom.

Note:

- In dusty places, use the fan with the drain cap (drain plug) attached and open the drain from time to time.

(With the motor cover)

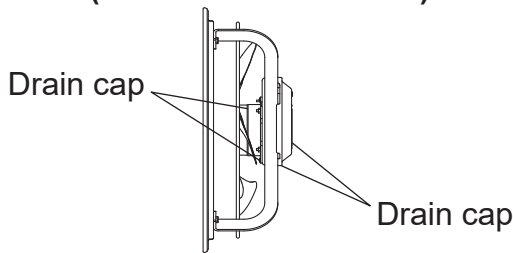

(Without the motor cover)

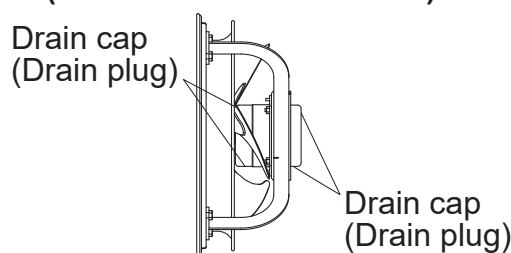

■ Installation of main unit

- When the fan is directly installed on a wall surface as exhaust heat

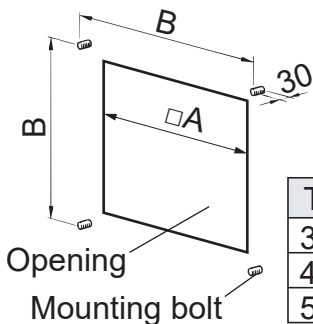

Unit (mm)			
Type	A	B	Bolt diameter
35cm	370	434	M8
40cm	410	460	M12
50cm	510	560	M12

1. Provide an opening and mount the mounting bolts in the locations indicated on the figure on the left.

2. Mount the fan.

Put the mounting bolts through the mounting holes and then use washers and nuts to secure them properly.

Note:

- Do not use the knock out holes for product mounting. (Product vibration, drop/deformation cause)
- Mounting bolt shall be fixed with a sufficient strength to withstand 4 times weight of the fan.

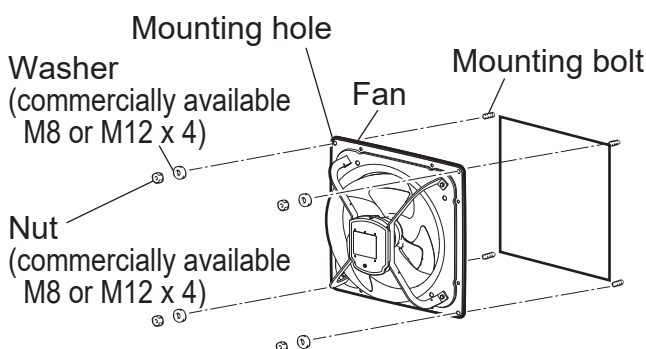

6. Electrical Work

⚠ WARNING

Do not use the fan at other than the rated voltage and frequency
 - Failure to heed this warning may result in fire or electric shock.
Be sure to install the ground wire
 - Device failure and electric leakage may cause electric shock.

⚠ CAUTION

Electrical work must be performed according to the standards of each country. Never perform connection by hand-twisting wires. Furthermore, power lines must be connected inside a box and box cover for rigid metal conduit
 - Connection failure and faulty wiring work could result in electric shock or fire.

- Perform connection after checking that the power supply is correct. If the fan is operated with the wrong power supply, the motor could burn out.
- Be sure to install an electric leakage breaker.
- Always ground the grounding terminal.
- Circuit breakers conforming to EN60947-2 must be used. Circuit breakers of which contact gaps are 3 mm or more must be used. We recommended a Mitsubishi Electric non-fuse circuit breaker (Model: NF32-SVF [Rated current: 15 A, number of poles: 3]).
- Connect the TN system to a 3-phase, 3-wire power supply.
- The ground wire must always be connected.
- For wires that are to be connected to the power cord including the grounding wire, use electrical wire with a copper conductor size of 0.75 mm² or above rated for a voltage of 300 V between conductor and ground and a voltage of 500 V, 7 A, or above between conductors.
- To connect to the power supply, install a metal electrical conduit box near the fan installation area (within 0.8 m in direct distance) and make connections inside the box.
- Install another separate metal box, and connect the circuit breaker and the electromagnetic switch together inside the box.
- To protect against overload on the motor, use overload protection equipment that employs a magnetic switch (magnetic contact + thermal relay). Overload protection equipment must be attached for every unit. A magnetic switch conforming to EN60947-4-1 must be used. We recommend a magnetic switch manufactured by Mitsubishi (model: MSO-T10 (The specification is described in Table 1)). The setting current value of the magnetic switch must be set per the information described in Table 2.

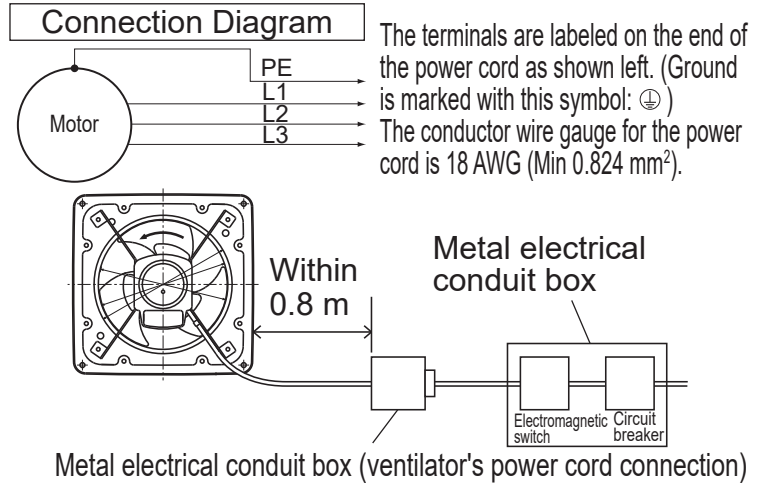

Table 1. Specification of MSO-T10

Coil (kW)			Auxiliary Contact Standard (spec.)
220-220V	380-440V	500-550V	
2.2	2.7	2.7	1a (1b)
Combination with Thermal Relay			
Model	Heater Desig.(A)		
TH-N12 (KP)	0.12, 0.17, 0.24, 0.35, 0.5, 0.7, 0.9, 1.3, 1.7, 2.1, 2.5, 3.6, 5, 6.6, 9		

Table 2. Magnetic Switch Setting Current Value

Power Supply	Model	Magnetic Switch Setting Current Value (A)		Heater Desig. (A)
		50Hz	60Hz	
Three-phase 50/60Hz 200-220V	EF-35UDT ₂ -GL	1.3	1.4	1.3
	EF-40UET ₂ -GL	2.3	2.7	2.5
	EF-50UFT ₂ -GL	3.2	3.2	3.6
Three-phase 50/50/50/60/60Hz 380/400/415/400/440V	EF-35UDT40A ₂ -GL	0.7	0.65	0.7
	EF-40UET40A ₂ -GL	1.2	1.2	1.3
	EF-50UFT40A ₂ -GL	1.7	1.7	1.7

7. Check after installation

When completing installation, check the fan according to Section 5 and 6. Be sure to correct any problems that are found. (Failure to correct the problems may result in poor performance, and furthermore safety cannot be ensured.)

8. Trial Operation

After installation work, check the following items.

1. Is the fan installed correctly?
2. Is not the power cord damaged?
3. Has grounding work been performed correctly?
4. Is the power supply voltage correct?

Turn ON the breaker to perform trial operation.







5. Is not there abnormal vibration or noise?
(Where there is an abnormality, stop operation and check the electrical work.)
6. Is the rotation direction reversed?
(If the rotation direction is reversed, switch two of the three power wires.)



Handling Explanation

(For customers)

1. Safety Precautions

The type and degree of danger resulting from incorrect handling are denoted by the following symbols.

 WARNING		Incorrect handling could result in death or serious injury
 No water exposure	Refrain from immersing in water or splashing the product with water. - Failure to heed this warning could result in short circuit, electric shock or fire.	
 No disassembly	Never make modification under any circumstances. Only qualified personnel can perform disassembly and repair. - Failure to heed this warning may result in fire, electric shock or injury. For repair, contact the dealer from whom you purchased the fan.	
 Touching prohibited	Do not insert fingers or objects into the fan during operation as doing so is dangerous - Failure to heed this warning may result in injury.	
	Never touch the fan when it is stopped with the power on, when there is an abnormality (for example, if you smell burning), or when there is a power outage. - It may start suddenly, resulting in injury or electric shock.	
 No wet hands	Do not operate with wet hands. - Failure to heed this warning may result in electric shock or injury.	
 Follow instructions	Turn off the distribution board circuit breaker before proceeding with cleaning, maintenance, and inspection. - Failure to heed this warning may result in electric shock or injury.	

 CAUTION		Incorrect handling could result in injury or property damage to buildings and machinery
 Prohibited	Do not use the fan when it is subject to abnormal vibration. - Injury may result if the fan or parts should fall.	
	Do not use the fan in such a way that it is started and stopped more than 50 times a day - Injury could result if parts are damaged or fall.	
 Follow instructions	If the fan will not be operated for a long time, be sure to turn off the circuit breaker on the power distribution panel. - Failure to heed this warning may result in electric shock due to deteriorated insulation or fire due to electric leakage.	
	When the blades are stained badly, make sure to clean them. - Injury could result if parts are damaged or fall due to vibration.	
	Be sure to wear gloves during cleaning, maintenance and inspection. - Failure to heed this warning may result in injury caused by, for example, the edge of the plate.	

Installation work is carried out in accordance with the regulations of each country. After completing installation, check Trial Operation.



CAUTION

Incorrect handling could result in injury or property damage to buildings and machinery



Follow instructions

This appliance can be used by children aged from 8 years and above and persons with reduced physical, sensory or mental capabilities or lack of experience and knowledge if they have been given supervision or instruction concerning use of the appliance in a safe way and understand the hazards involved. Children shall not play with the appliance. Cleaning and user maintenance shall not be made by children without supervision.
(EN60335-2-80/EN60335-1)

This appliance is not intended for use by persons (including children) with reduced physical, sensory or mental capabilities, or lack of experience and knowledge, unless they have been given supervision or instruction concerning use of the appliance by a person responsible for their safety.

Children should be supervised to ensure that they do not play with the appliance.
(IEC60335-2-80/IEC60335-1)

If the supply cord is damaged, it must be replaced by the manufacturer, its service agent, or similar qualified persons in order to avoid a hazard.

2. How to Use the Fan

To operate ... Turn ON the breaker.

To stop ... Turn OFF the breaker.



WARNING

Do not insert fingers or objects into the fan during operation as doing so is dangerous

- Failure to heed this warning may result in injury.

Do not operate with wet hands

- Failure to heed this warning may result in electric shock or injury.

3. Maintenance



WARNING

Be sure to turn off the distribution panel circuit breaker before proceeding with cleaning and maintenance.

- Failure to heed this warning may result in electric shock or injury.



CAUTION

Wear gloves during cleaning and maintenance.

- Failure to heed this warning may result in injury caused by, for example, the edge of the plate.

Cleaning of blades, etc.

Cleaning should be performed about every three months.

- Wipe with a piece of cloth soaked in neutral detergent, and then wipe with a dry cloth so as not to leave any detergent behind.
- When the fan is used in a dusty location, approximately once every three months remove the drain cap (drain plug) on the bottom to drain off and then put the drain cap (drain plug) back on.

Overall cleaning

- If flammable material such as oil or dust adheres to the fan, the material could catch fire due to flying sparks.
Always perform periodic cleaning (about once a year).

Note:

- Do not use the following solvents when performing maintenance:

Paint thinner, alcohol, benzene, gasoline, kerosene, spray solvents, alkaline detergents, chemicals from wipes, or detergents containing abrasives such as cleansers, or the like. (Using such solvents could cause materials to become altered or discolored.)

4. Maintenance and Inspection



WARNING

Be sure to turn OFF the distribution panel circuit breaker before proceeding with maintenance and inspection.

- Failure to heed this warning may result in electric shock or injury.



CAUTION

Be sure to wear gloves during maintenance and inspection

- Failure to heed this warning may result in injury caused by, for example, the edge of the plate.

When performing cleaning once every three months, inspect the following items:

Item	Inspection content	Action
Rust	Is there rust on the fan itself or the nuts or bolts used to mount the product rusted?	Use urethane paint to address partial rusting. If there is rust on a significant portion of a part, replace the part. (Injury could result if the fan falls.)
	Is there rust on the blade fix nuts or the blades?	Use urethane paint to address partial rusting. If there is rust on a significant portion of a part, the part must be replaced. Ask your dealer or an electrical contractor to repair the unit. (Injury could result if the blades are damaged or the fan falls.)
Wobbling	Are the nuts used to mount the fan loose? Are the blades and motor properly secured?	Tighten the nuts so that the fan does not wobble. (Injury may result if the fan or blades fall)
Damage	Does the motor appear to be discolored?	The motor needs to be replaced. Ask your dealer or an electrical contractor to repair the fan.
	Is the power cable damaged?	The motor needs to be replaced. Ask your dealer or an electrical contractor to repair the fan.
	Are there cracks on the blades?	The blades need to be replaced. Ask your dealer or an electrical contractor to repair the fan. (Injury could result if the blades are damaged or the fan falls.)
Dust	Is there dust on high temperature parts such as the motor? If a filter or insect screen is used, is it clogged?	Perform cleaning.
Abnormal noise	Is there abnormal noise while the fan is turning?	The bearing or motor needs to be replaced. Ask your dealer or an electrical contractor to repair the fan. Note: The service life of the bearing is about 30,000 hours under continuous operation in a 50 °C environment. (The service life may get shorter depending on the operating environment) Inspect and replace if necessary.

5. Before Requesting Repair

After the fan used for a long time for safety, it is recommended that the fan be checked even if the fan has no trouble.

If the following phenomenon is found and cannot be corrected after inspection by the customer, turn off the breaker and ask your dealer or an electrical contractor to inspect and repair the fan. Please ask your dealer or an electrical contractor about the cost of repairs.

Phenomenon	Cause/Action	
The fan does not start even though the power is ON	The breaker is OFF	Turn ON the breaker
Stop and operation are repeated (For 200 V type)	The overload protection equipment of the motor is running	Turn OFF the power, remove the cause, wait until the motor gets cool and then turn ON the power (Note)
There is abnormal sound or vibration during operation	The blades are loose	Tighten Special nut
	The main unit is loose	Tighten main unit fix nuts
	There are abnormal sounds from the bearing	Change the bearing. Ask your dealer or an electrical contractor to repair the fan.
	Rust has occurred over a wide range	Replace rusted parts. Ask your dealer or an electrical contractor to repair the fan.
There is a burnt smell	Something is caught on the blades	Remove the caught object
	The ambient temperature has exceeded 50 °C	The fan cannot be used in a location where the ambient temperature exceeds 50 °C. Lower the ambient temperature or use another model.
	There is corrosion inside the motor	Change the motor. Ask your dealer or an electrical contractor to repair the fan.

Note:

The fan has a built-in auto-resetting thermal protector inside for protection against the damage by a fire. (200 V type)

The above overload protection equipment will activate automatically to stop rotation in the case of locked operation, overloading, open-phase operation, application of incorrect voltage, or an ambient temperature in excess of the rated level. If this should occur, turn OFF the power and eliminate the cause of the problem.

(Use of a filter or insect screen could cause clogging.)

To restart operation, take the following action.

<Action>

Turn OFF the power, remove the cause and wait until the motor gets cool, then use the fan after confirming that the motor operates normally.

If power is not switched OFF and continues to be supplied, the thermal protector will trip repeatedly, resulting in a contact failure or contact welding.

If this should happen, the motor must be changed. Switch OFF the power and ask a qualified electrical contractor to change the motor.

6. After-Sales Service

For after-sales service, ask the sales agent from whom you purchased the product.
To change the motor, contact your dealer and tell the fan model name to request repair.

■ Retention period of functional repair parts

We will retain the functional repair parts for nine years after terminating production of the product.
The functional repair part means a part which is necessary to maintain the function of the product.

7. Specifications

Model	Blade diameter (cm)	Voltage (V)	Frequency (Hz)	Air volume (m ³ /h)	Noise (dB)	Current (A)	Power Consumption (W)	Maximum load current (A)	Starting current (A)	Weight (kg)
EF-35UDT ₂ -GL	35	Three-phase 200-220	50	3000	45-45.5	0.85-1.0	130-145	0.98-1.06	5.37-6.01	9.2
EF-40UET ₂ -GL	40			4800	52-52	1.45-1.67	245-273	1.90-1.95	15.0-16.0	13.2
EF-50UFT ₂ -GL	50			7200	52-52	2.00-2.25	370-400	2.75-2.65	20.1-21.3	19.5
EF-35UDT ₂ -GL	35		60	3600	49-49.5	0.8-0.85	180-185	1.15-1.14	4.96-5.28	9.2
EF-40UET ₂ -GL	40			5520	55-55.5	1.44-1.50	355-374	2.3-2.1	13.6-14.5	13.2
EF-50UFT ₂ -GL	50			8400	56-56.5	2.1-2.1	530-560	2.75-2.7	18.4-19.3	19.5
EF-35UDT40A ₂ -GL	35	Three-phase 380/400/415	50	3000	44.5/45/45	0.47/0.5/0.54	136/145/150	0.55/0.57/0.59	3.00/3.12/3.20	9.2
EF-40UET40A ₂ -GL	40			4800	51.5/52/52	0.76/0.78/0.86	265/275/285	1.0/1.02/1.04	7.00/7.35/7.50	13.2
EF-50UFT40A ₂ -GL	50			7200	52/52/52	0.95/1.00/1.05	345/365/375	1.39/1.40/1.40	9.9/10.5/10.7	19.5
EF-35UDT40A ₂ -GL	35	Three-phase 400/440	60	3600	49/49.5	0.44/0.47	185/195	0.54/0.56	2.89/3.05	9.2
EF-40UET40A ₂ -GL	40			5520	55/55.5	0.77/0.80	370/390	1.01/1.00	6.72/7.10	13.2
EF-50UFT40A ₂ -GL	50			8400	56/56	1.03/1.05	540/545	1.46/1.28	9.56/10.3	19.5

Fan Efficiency

Item	Model Name	EF-35UDT ₂ -GL	EF-40UET ₂ -GL	EF-50UFT ₂ -GL	EF-35UDT40A ₂ -GL	EF-40UET40A ₂ -GL	EF-50UFT40A ₂ -GL
1	Overall Efficiency	28.5	30.5	31.8	28.7	30.6	31.8
2	Measurement Category	A					
3	Efficiency Category	Static					
4	Efficiency Grade	40	40	40	40	40	40
5	VSD	N/A					
6	Year of Manufacture	2022	2022	2022	2022	2022	2022
7	Manufacturer Information	MITSUBISHI ELECTRIC CORPORATION Tokyo Bldg., 2-7-3, Marunouchi, Chiyoda-ku, Tokyo 100-8310, Japan					
8	Model Number	EF-35UDT ₂ -GL	EF-40UET ₂ -GL	EF-50UFT ₂ -GL	EF-35UDT40A ₂ -GL	EF-40UET40A ₂ -GL	EF-50UFT40A ₂ -GL
9	Motor Power Input (kW)	0.15	0.31	0.51	0.17	0.32	0.51
	Flow Rate (m ³ /s)	0.56	0.92	1.25	0.55	0.89	1.25
	Total Static Pressure (Pa)	80	99	145	83	106	148
10	Rotations per Minute	1436	1460	1445	1436	1458	1445
11	Specific Ratio	1					
12	Information relevant for facilitating disassembly, recycling or disposal at end-of-life	This fan should be disposed of separately from household waste in line with local laws and regulations. When this fan reaches its end of life, dispose of it at your local waste collection point/recycling centre. The separate collection and recycling of this fan at the time of disposal will help conserve natural resources and ensure that it is recycled in a manner that protects human health and the environment. For more information please contact us at http://www.mitsubishielectric.co.jp/factory/sofuki/					
13	Information relevant to minimise impact on the environment and ensure optimal life expectancy as regards installation, use and maintenance of the fan	<Cleaning of blades, etc.> Cleaning should be performed about every three months. <Overall cleaning> If flammable material such as oil or dust adheres to the fan, the material could catch the fire due to flying sparks. Always perform periodic cleaning (about once a year). - Do not use the following solvents when performing maintenance: Paint thinner, alcohol, benzene, gasoline, kerosene, spray solvents, alkaline detergents, chemicals from wipes, or detergents containing abrasives such as cleansers, or the like.					
14	Description of additional items used when determining the fan energy efficiency	The optimal fan efficiency is measured in the composition of fan only.					

MITSUBISHI ELECTRIC CORPORATION

Manufactured by: MITSUBISHI ELECTRIC CORPORATION

TOKYO BLDG. 2-7-3, MARUNOUCHI, CHIYODA-KU, TOKYO, 100-8310 JAPAN