

■ 部材外観図 (収納個数)

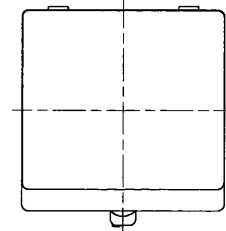

■ 部材名称

型名、名称、他	数量
01 P-13KQU ₂ 自然給気ユニット (白)	5
02 P-13KQU ₂ -BE 自然給気ユニット (ベージュ)	1
03 P-13VP-BK 深形フード (黒) : プラスチック製	6

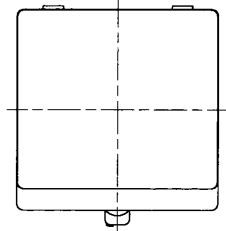
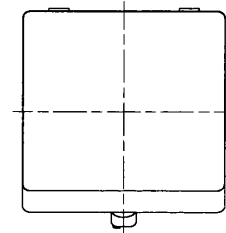
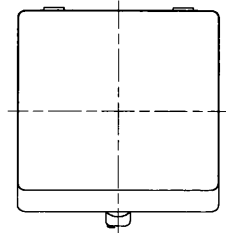
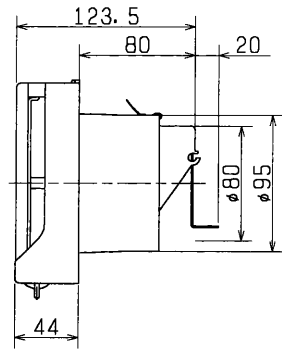
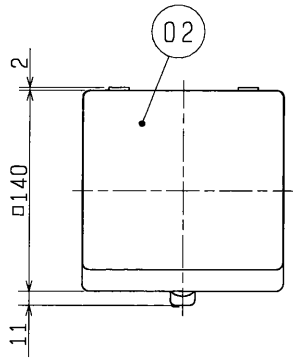
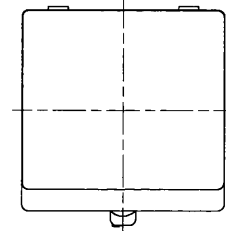
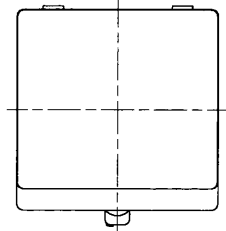
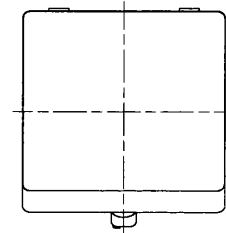
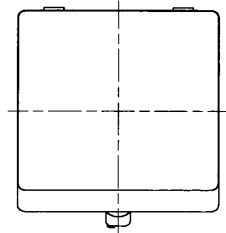
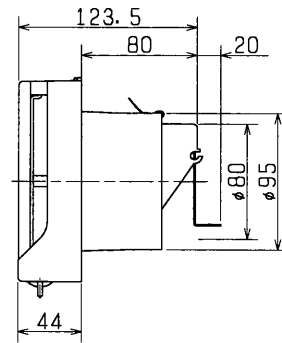
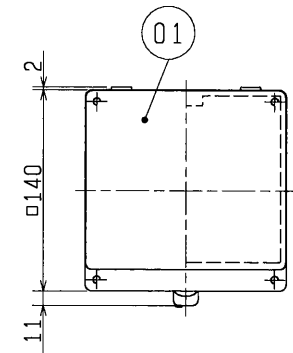
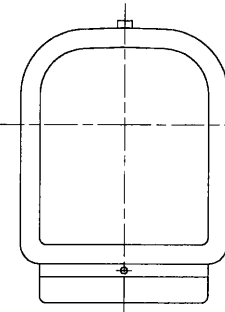
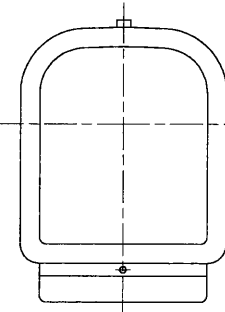
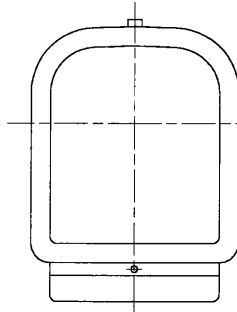
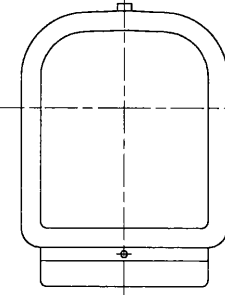
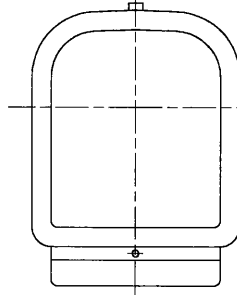
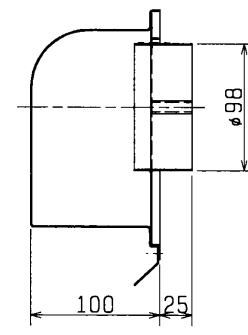
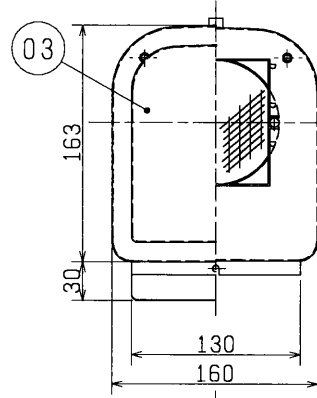

※仕様は場合により変更することがあります。

第 3 角 図 法	作成日付	形 名	P-13KQU ₂ -PAC	
	01. 4. 1		エアフロー環気システム セントラル排気システム用給気部材パック	
三菱電機株式会社 中津川製作所		整理番号	NB301014	1/1