

形名	AZ-B21500BM/8 AHZF	電源		○諸特性
出力	連調調色	温度		
モード	森の昼空*フレーム部50%			
オプション1	AZ-XP0003			
オプション2				
オプション3				
オプション4				
オプション5				

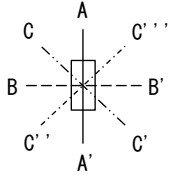

光源		LED					
最大 取付 間隔	高さ	H					
	A-A'	0.0 H					
	B-B'	0.0 H					
器具効率		上方光束	下方光束	計			
		0.0%	100.0%	100.0%			
保守率		良い	0.810	普通	0.770	悪い	0.680

○配光曲線図 (cd/1000lm)

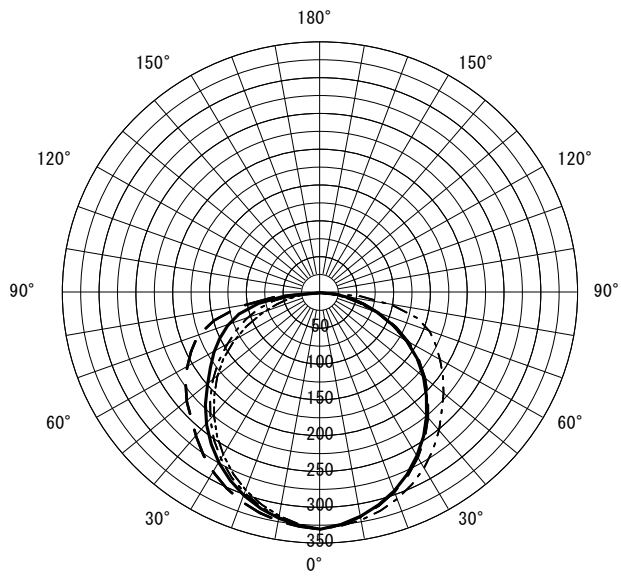

○直射水平面照度 (全光束: 0 × 1 = 0lm/台)



反射率 (%)																																						
天井	80								70								50								30								20	0				
壁	70	50	30	10	70	50	30	10	70	50	30	10	70	50	30	10	70	50	30	10	70	50	30	10	70	50	30	10	10	0								
床	30	10	30	10	30	10	30	10	30	10	30	10	30	10	30	10	30	10	30	10	30	10	30	10	30	10	30	10	30	10	30	10	10	0				
室指数	作業面照明率 (× 0.01)																																					
0.60	61	56	46	44	37	36	31	30	59	55	45	43	36	35	30	30	56	52	44	42	36	35	30	30	53	50	42	41	35	34	30	30	30	30	28			
0.80	73	66	58	54	48	46	41	40	70	64	56	53	47	46	41	40	66	62	54	52	46	45	40	40	62	59	52	51	45	44	40	39	39	37				
1.00	81	72	66	61	56	53	49	47	78	71	65	60	55	53	49	47	73	68	62	59	54	52	48	47	69	65	60	57	53	51	47	46	46	44				
1.25	88	78	74	68	65	61	57	55	85	77	73	67	64	60	57	54	80	74	69	65	62	59	56	54	75	71	67	64	60	58	55	54	53	51				
1.50	94	83	81	73	71	66	64	60	91	81	79	72	70	65	63	60	85	78	75	70	68	64	62	59	79	75	72	68	65	63	60	59	59	56				
2.00	102	88	90	81	81	74	74	69	98	87	88	79	80	73	73	68	91	83	83	77	76	72	71	68	86	81	79	75	73	71	69	67	66	64				
2.50	107	92	97	85	88	80	82	75	103	90	94	84	86	79	80	74	96	87	89	82	83	77	77	73	90	84	84	80	79	76	75	72	72	70				
3.00	110	95	101	89	94	84	88	79	106	93	98	88	92	83	86	79	99	90	93	85	87	81	82	78	93	87	88	83	83	80	79	76	76	74				
4.00	115	98	108	93	101	89	96	85	111	96	104	92	99	88	94	85	103	93	98	90	93	86	89	83	97	91	93	88	89	85	86	82	81	79				
5.00	118	100	112	96	106	93	101	89	114	99	108	95	103	92	99	89	106	96	102	93	98	90	94	87	99	93	96	90	93	88	90	86	85	83				
7.00	122	102	117	99	113	97	109	94	117	101	113	98	109	96	106	93	109	98	106	96	103	94	100	92	102	96	99	94	97	92	95	90	89	87				
10.00	125	104	121	102	118	100	115	98	120	103	117	101	114	99	111	97	111	100	109	99	107	97	105	95	104	98	102	96	101	95	99	94	93	91				

JIS C 8030:2014

三菱電機照明株式会社