

形名	AZ-B21501BM/8 AHZS	電源		○諸特性
出力	連調調色	温度		
モード	海の昼空*フレーム部75%			
オプション1	AZ-XP0002			
オプション2				
オプション3				
オプション4				
オプション5				

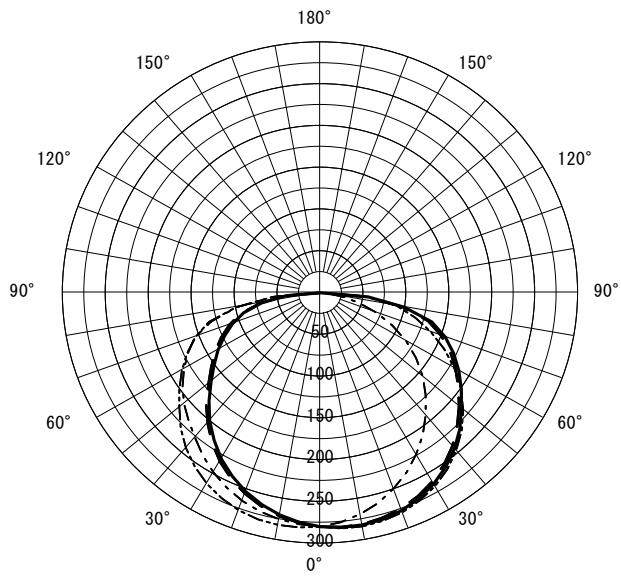

光源		LED					
最大 取付 間隔	高さ	H					
	A-A'	0.0 H					
	B-B'	0.0 H					
器具効率		上方光束	下方光束	計			
		0.0%	100.0%	100.0%			
保守率		良い	0.810	普通	0.770	悪い	0.680

○配光曲線図 (cd/1000lm)



○直射水平面照度 (全光束: 0 × 1 = 0lm/台)



反射率 (%)																																						
天井	80								70								50								30								20	0				
壁	70	50	30	10	70	50	30	10	70	50	30	10	70	50	30	10	70	50	30	10	70	50	30	10	70	50	30	10	10	0								
床	30	10	30	10	30	10	30	10	30	10	30	10	30	10	30	10	30	10	30	10	30	10	30	10	30	10	30	10	30	10	30	10	10	0				
室指数	作業面照度 (× 0.01)																																					
0.60	59	54	43	41	34	33	28	27	57	53	43	41	34	33	28	27	54	50	41	40	33	32	27	27	51	48	40	38	32	32	27	27	27	25				
0.80	70	64	55	52	45	43	38	37	68	62	54	51	44	43	38	37	64	59	52	49	43	42	37	37	60	57	50	48	42	41	37	36	36	34				
1.00	78	71	63	59	53	50	46	44	76	69	62	58	52	50	45	44	71	66	59	56	51	49	44	43	67	63	57	55	49	48	44	43	43	41				
1.25	86	77	72	66	61	58	54	51	83	75	70	65	60	57	53	51	78	71	67	63	59	56	52	51	73	68	64	61	57	55	51	50	50	48				
1.50	92	81	78	71	68	63	60	57	88	79	76	70	67	63	60	57	82	76	72	68	64	61	58	56	77	73	69	66	62	60	57	56	55	53				
2.00	100	87	88	78	78	71	71	66	96	85	85	77	77	71	70	65	89	82	81	75	74	69	68	65	84	79	77	73	71	68	66	64	63	61				
2.50	105	91	94	83	86	77	79	72	101	89	92	82	84	76	77	71	94	86	86	80	80	75	74	70	88	83	82	78	76	73	72	70	69	67				
3.00	109	93	99	87	91	81	85	77	105	92	96	86	89	81	83	76	97	88	91	83	85	79	80	75	91	85	86	81	81	77	77	74	73	71				
4.00	114	97	106	92	99	87	93	83	110	95	103	91	97	86	91	82	102	92	96	88	91	84	87	81	95	89	91	86	87	83	83	80	79	77				
5.00	117	99	110	95	105	91	99	87	113	98	107	94	101	90	97	87	105	95	100	91	96	88	92	85	98	92	94	89	91	86	88	84	83	81				
7.00	121	102	116	99	111	95	107	93	116	100	112	97	108	94	104	92	108	97	105	95	101	93	98	90	101	95	98	93	96	91	93	89	88	86				
10.00	124	104	120	101	117	99	113	97	119	102	116	100	113	98	110	96	111	100	108	98	106	96	103	94	103	97	101	96	100	94	98	93	92	90				

JIS C 8030:2014

三菱電機照明株式会社