

形名	EL-G75201AN/6 AHZ	電源		○諸特性
出力	連調単色	温度		
モード				
オプション1				
オプション2				
オプション3				
オプション4				
オプション5				

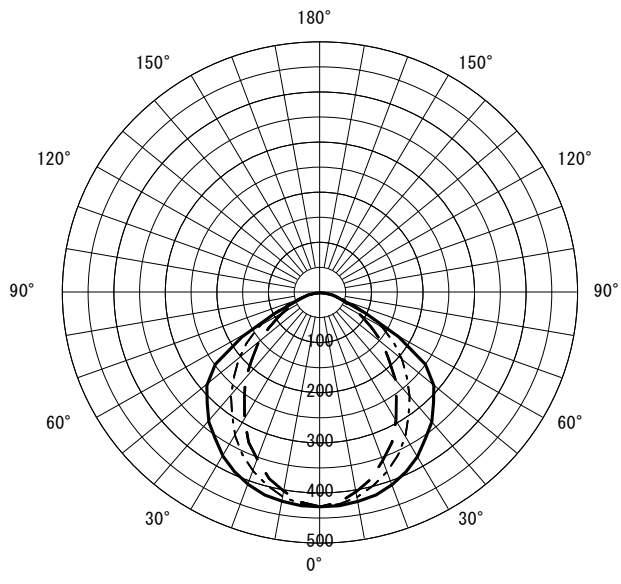

光源		LED					
最大 取付 間隔	高さ	H					
	A-A'	1.3 H					
	B-B'	1.1 H					
器具効率		上方光束	下方光束	計			
		0.0%	100.0%	100.0%			
保守率		良い	0.860	普通	0.810	悪い	0.720

○配光曲線図 (cd/1000lm)



○直射水平面照度 (全光束: 7510 × 1 = 7510lm/台)
照度 (lx) — H1.50m --- H2.00m - - - H2.50m - · - · H3.00m (保守率: 1.00)

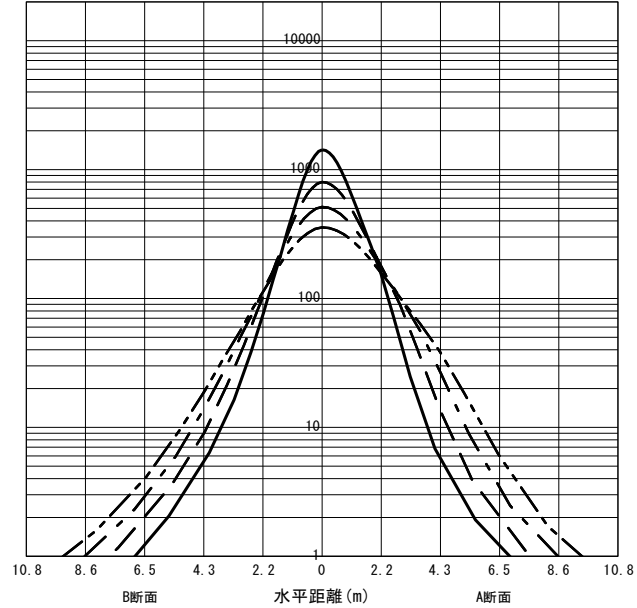

反射率 (%)																																						
天井	80								70								50								30								20	0				
壁	70	50	30	10	70	50	30	10	70	50	30	10	70	50	30	10	70	50	30	10	70	50	30	10	70	50	30	10	10	0								
床	30	10	30	10	30	10	30	10	30	10	30	10	30	10	30	10	30	10	30	10	30	10	30	10	30	10	30	10	30	10	30	10	10	0				
室指数	作業面照明率 (× 0.01)																																					
0.60	66	61	52	49	43	42	38	37	64	60	51	49	43	42	37	37	61	57	50	48	42	41	37	37	58	55	48	47	42	41	37	37	37	35				
0.80	78	71	65	61	56	53	49	48	76	70	63	60	55	53	49	48	72	67	61	59	54	52	49	48	69	65	60	57	53	52	48	48	47	46				
1.00	87	78	73	68	65	61	58	56	84	76	72	67	64	61	58	56	79	74	69	66	62	60	57	56	75	71	67	64	61	59	56	55	55	53				
1.25	94	84	82	75	73	69	67	64	91	82	80	74	72	68	66	63	86	79	77	73	70	67	65	63	82	77	74	71	68	66	64	62	62	60				
1.50	99	87	88	80	80	74	73	69	96	86	86	79	78	73	72	69	91	83	82	77	76	72	71	68	86	81	79	75	73	71	69	68	67	65				
2.00	106	93	97	86	89	81	83	77	103	91	94	85	87	80	82	76	97	88	90	83	84	79	79	76	91	86	86	82	81	78	77	75	74	73				
2.50	111	96	102	90	95	86	90	82	107	94	100	89	93	85	88	82	101	92	94	87	89	84	85	81	95	89	90	85	86	82	82	80	79	77				
3.00	114	98	107	93	100	89	95	86	110	96	103	92	98	88	93	85	103	94	98	90	93	87	89	84	97	91	93	88	89	85	86	83	82	81				
4.00	118	101	112	97	107	94	102	91	114	99	109	96	104	93	100	90	107	97	102	94	99	91	95	89	100	94	97	92	94	90	91	88	87	85				
5.00	121	102	116	99	111	96	107	94	116	101	112	98	108	96	104	93	109	98	105	96	102	94	99	92	102	96	99	94	97	92	95	90	90	88				
7.00	124	104	120	102	116	100	113	98	119	103	116	101	113	99	110	97	111	100	109	99	106	97	104	95	104	98	102	96	100	95	99	94	93	91				
10.00	126	105	123	104	120	102	118	101	121	104	119	103	117	101	114	100	113	102	111	100	109	99	108	98	106	99	104	98	103	97	102	96	96	94				

JIS C 8030:2014

三菱電機照明株式会社