

形名	EL-LFB45001C AHN (25N5)	電源		○諸特性
出力	固定出力	温度		
モード				
オプション1				
オプション2				
オプション3				
オプション4				
オプション5				

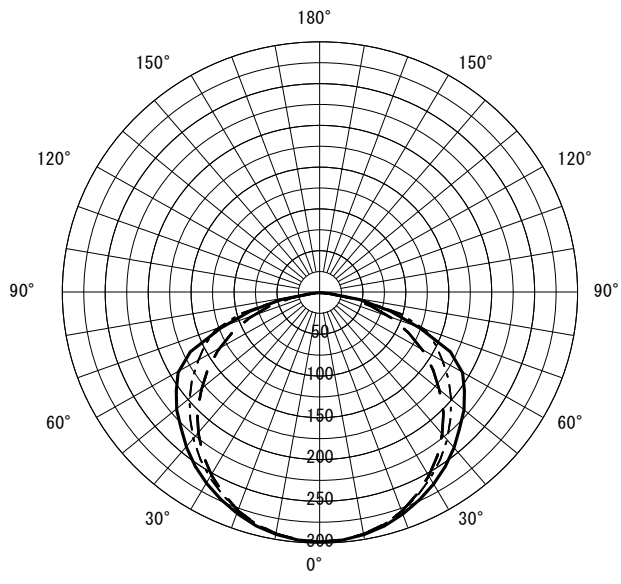

光源		LDL40S-D/17/24-N4					
最大 取付 間隔	高さ	H					
	A-A'	1.3 H					
	B-B'	1.3 H					
器具効率		上方光束	下方光束	計			
		0.0%	96.2%	96.2%			
保守率		良い	0.830	普通	0.810	悪い	0.770

○配光曲線図 (cd/1000lm)



○直射水平面照度 (全光束: 2400 × 1 = 2400lm/台)  
照度 (lx) — H1.50m --- H2.00m - - - H2.50m - · - · H3.00m (保守率: 1.00)

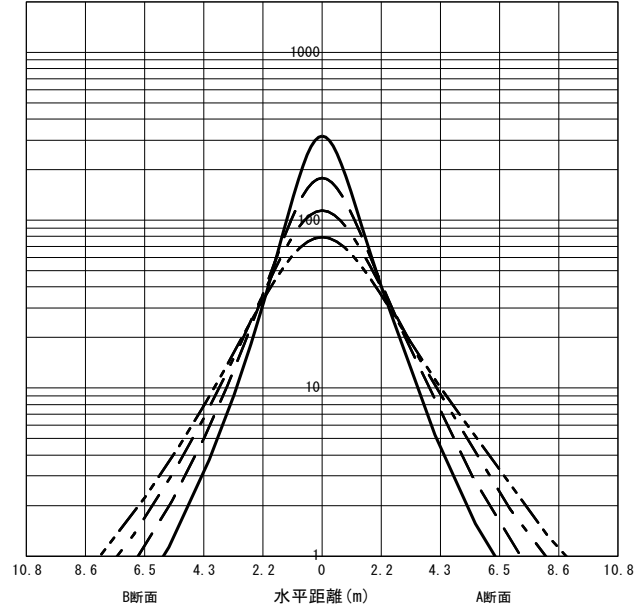

反射率 (%)																																		
天井	80								70								50								30								20	0
壁	70	50	30	10	70	50	30	10	70	50	30	10	70	50	30	10	70	50	30	10	70	50	30	10	70	50	30	10	10	0				
床	30	10	30	10	30	10	30	10	30	10	30	10	30	10	30	10	30	10	30	10	30	10	30	10	30	10	30	10	30	10	10	0		
室指数	作業面照明率 (× 0.01)																																	
0.60	58	54	43	41	35	34	29	28	56	52	43	41	34	33	29	28	53	50	41	40	34	33	28	28	50	48	40	39	33	33	28	28	28	26
0.80	70	63	55	52	46	44	39	38	67	62	54	51	45	43	39	38	63	59	52	50	44	43	38	38	60	56	50	48	43	42	38	38	37	35
1.00	78	70	63	59	54	51	47	45	75	68	62	58	53	51	47	45	70	65	59	56	52	50	46	45	66	62	57	55	50	49	45	44	44	42
1.25	85	76	72	66	62	58	55	53	82	74	70	65	61	58	55	52	77	71	67	63	59	57	54	52	72	68	64	61	58	56	53	52	51	49
1.50	91	80	78	71	69	64	62	58	87	78	76	70	68	63	61	58	82	75	72	68	65	62	60	58	77	72	69	66	63	61	58	57	57	55
2.00	98	85	87	78	79	72	72	67	95	84	85	77	77	71	71	67	88	81	81	75	74	70	69	66	83	78	77	73	71	69	67	65	65	63
2.50	103	89	94	83	86	77	80	73	99	87	91	82	84	77	78	72	93	84	86	79	80	75	75	71	87	82	82	77	77	74	73	71	70	68
3.00	107	92	98	86	91	81	85	77	103	90	95	85	89	81	84	77	96	87	90	83	85	79	80	76	90	84	85	81	81	78	77	75	74	72
4.00	111	95	105	90	99	87	93	83	107	93	101	89	96	86	91	83	100	91	95	87	91	84	87	81	94	88	90	85	87	82	83	80	79	77
5.00	114	97	109	93	103	90	99	87	110	95	105	92	100	89	96	86	103	93	99	90	95	87	92	85	96	90	93	88	90	86	87	84	83	81
7.00	118	99	113	96	109	94	106	92	113	98	109	95	106	93	103	91	105	95	102	93	100	91	97	89	99	93	96	91	94	89	92	88	87	85
10.00	120	101	117	99	114	97	111	95	116	99	113	98	110	96	108	94	108	97	106	95	103	94	102	93	101	95	99	93	97	92	96	91	90	88

JIS C 8030:2014

三菱電機照明株式会社