

形名	EL-LFB45702B AHX (25N5)	電源		○諸特性
出力	連調単色	温度		
モード				
オプション1				
オプション2				
オプション3				
オプション4				
オプション5				

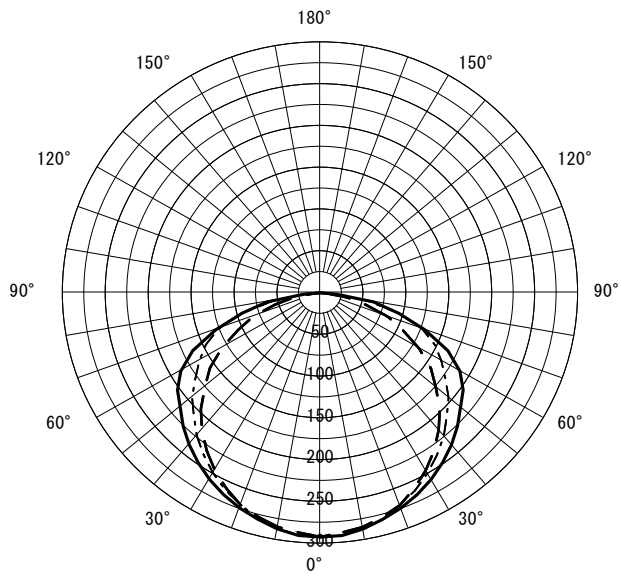

光源		LDL40S-D/17/24-N4					
最大 取付 間隔	高さ	H					
	A-A'	1.3 H					
	B-B'	1.3 H					
器具効率		上方光束	下方光束	計			
		0.0%	94.8%	94.8%			
保守率		良い	0.810	普通	0.770	悪い	0.680

○配光曲線図 (cd/1000lm)



○直射水平面照度 (全光束: 2400 × 2 = 4800lm/台)

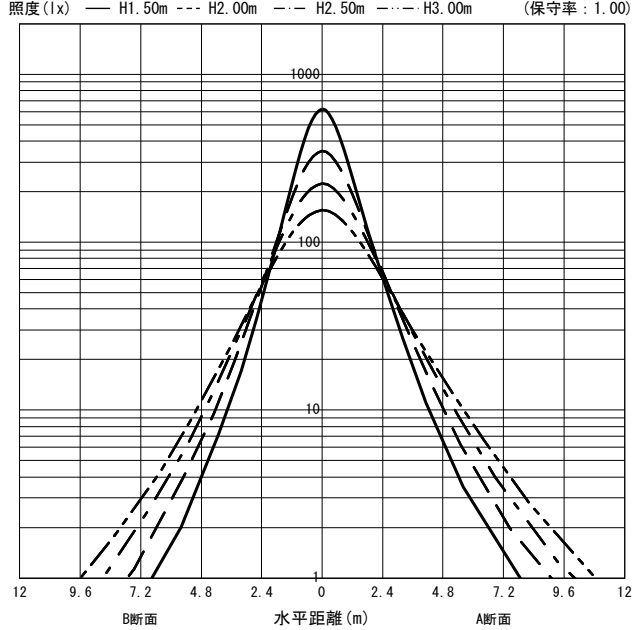

反射率 (%)																																										
天井	80								70								50								30								20	0								
壁	70	50	30	10	70	50	30	10	70	50	30	10	70	50	30	10	70	50	30	10	70	50	30	10	70	50	30	10	10	0												
床	30	10	30	10	30	10	30	10	30	10	30	10	30	10	30	10	30	10	30	10	30	10	30	10	30	10	30	10	30	10	30	10	30	10	30	10	30	10	30	10	10	0
室指数	作業面照明率 (× 0.01)																																									
0.60	57	53	43	41	34	33	28	28	55	51	42	40	34	33	28	27	52	49	40	39	33	32	28	27	49	47	39	38	32	32	27	27	27	25								
0.80	68	62	54	51	45	43	38	37	66	61	53	50	44	42	38	37	62	58	51	49	43	42	37	37	59	55	49	47	42	41	37	37	36	35								
1.00	76	68	62	58	53	50	46	44	74	67	61	57	52	50	45	44	69	64	58	55	51	49	45	44	65	61	56	54	49	48	44	43	43	41								
1.25	83	74	70	64	61	57	54	51	81	73	69	64	60	57	53	51	75	70	66	62	58	56	52	51	71	67	63	60	56	55	51	50	50	48								
1.50	89	78	76	69	67	62	60	57	86	77	75	68	66	62	60	57	80	74	71	67	64	61	58	56	75	71	68	65	62	60	57	56	55	53								
2.00	96	84	86	76	77	70	70	65	93	82	83	75	76	70	69	65	87	79	79	73	73	68	67	64	81	76	75	71	70	67	65	64	63	61								
2.50	101	87	92	81	84	76	78	71	98	86	89	80	82	75	76	71	91	83	84	78	79	74	74	70	85	80	80	76	75	72	71	69	68	66								
3.00	105	90	96	84	89	80	83	75	101	88	94	83	87	79	82	75	94	86	88	81	83	77	79	74	88	83	83	79	79	76	76	73	72	70								
4.00	110	93	103	89	97	85	91	81	105	92	99	88	94	84	89	81	98	89	93	85	89	82	85	80	92	86	88	83	85	81	82	78	78	76								
5.00	112	95	107	91	101	88	97	85	108	94	103	90	98	87	94	85	101	91	97	88	93	86	90	83	94	88	91	86	88	84	86	82	81	79								
7.00	116	97	111	95	107	92	104	90	111	96	108	94	104	91	101	89	104	93	101	91	98	89	95	88	97	91	95	89	92	88	90	86	85	83								
10.00	118	99	115	97	112	95	109	94	114	98	111	96	108	94	106	93	106	95	104	94	102	92	100	91	99	93	97	92	96	91	94	89	89	87								

JIS C 8030:2014

三菱電機照明株式会社