

形名	EL-LFH4522C AHX (39N4)	電源		○諸特性
出力	連調単色	温度		
モード				
オプション1				
オプション2				
オプション3				
オプション4				
オプション5				

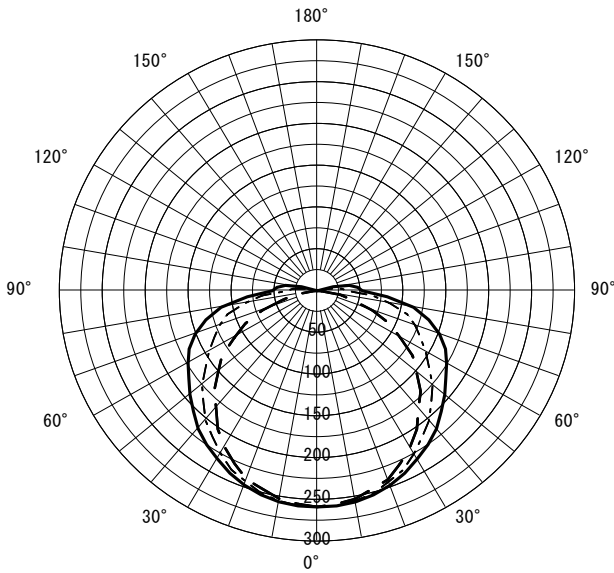

光源		LDL40S-L/24/33-N4					
最大 取付 間隔	高さ	H					
	A-A'	1.3 H					
	B-B'	1.2 H					
器具効率		上方光束	下方光束	計			
		3.4%	91.4%	94.8%			
保守率		良い	0.880	普通	0.860	悪い	0.810

○配光曲線図 (cd/1000lm)



○直射水平面照度

(全光束 : 3300 × 2 = 6600lm/台)

照度 (lx) — H1.50m --- H2.00m - - - H2.50m - · - · H3.00m (保守率 : 1.00)

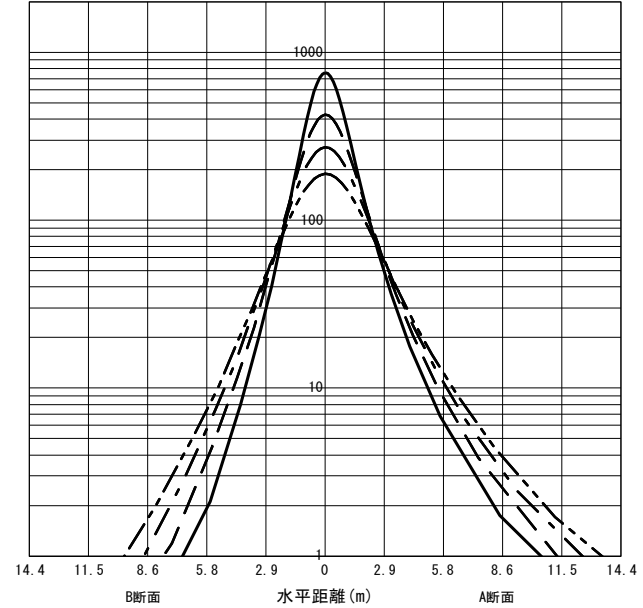

反射率 (%)																																		
天井	80				70				50				30				20	0																
壁	70	50	30	10	70	50	30	10	70	50	30	10	70	50	30	10	70	50	30	10	10	0												
床	30	10	30	10	30	10	30	10	30	10	30	10	30	10	30	10	30	10	30	10	30	10	30	10	30	10	30	10	30	10	10	0		
室指数	作業面照度率 (× 0.01)																																	
0.60	55	51	41	39	32	31	26	26	53	50	40	38	32	31	26	25	50	47	38	37	31	30	25	25	47	44	37	36	30	29	25	25	25	23
0.80	66	60	51	48	42	40	35	34	64	58	50	47	41	40	35	34	59	55	48	46	40	39	34	34	55	52	46	44	39	38	34	33	33	31
1.00	74	66	59	55	50	47	42	41	71	64	58	54	49	46	42	41	66	61	55	52	47	45	41	40	61	58	52	50	45	44	40	40	39	37
1.25	81	72	67	61	57	54	50	48	78	70	65	60	56	53	49	47	72	66	62	58	54	52	48	47	67	63	58	56	52	50	47	46	45	43
1.50	86	76	73	66	63	59	56	53	83	74	71	65	62	58	55	53	76	70	67	63	59	57	54	52	71	67	63	60	57	55	52	51	50	48
2.00	93	81	82	73	73	67	66	61	90	79	79	72	71	66	65	60	83	76	74	69	68	64	62	59	77	72	70	67	64	62	60	58	58	55
2.50	98	85	88	78	80	72	73	67	94	83	85	76	78	71	71	66	87	79	80	74	73	69	68	65	80	76	75	71	70	67	65	63	63	60
3.00	102	87	93	81	85	76	79	71	98	85	89	80	83	75	77	70	90	82	84	77	78	73	73	69	83	78	78	74	74	71	70	67	67	64
4.00	107	91	99	86	92	81	87	77	102	89	95	84	89	80	84	76	94	85	89	81	84	78	80	74	87	82	83	79	79	75	76	73	72	69
5.00	110	93	103	88	97	85	92	81	105	91	99	87	94	83	89	80	97	87	92	84	88	81	84	78	90	84	86	81	83	79	80	76	75	73
7.00	113	95	108	92	104	89	99	86	109	93	104	90	100	88	96	85	100	90	96	88	93	85	90	83	93	87	90	85	87	83	85	81	80	77
10.00	116	97	112	95	109	92	105	90	111	95	108	93	105	91	102	89	103	92	100	90	97	89	95	87	95	89	93	88	91	86	89	85	83	81

JIS C 8030:2014

三菱電機照明株式会社