

形名	EL-LFH4912B AHN (25N5)	電源		○諸特性
出力	固定出力	温度		
モード				
オプション1				
オプション2				
オプション3				
オプション4				
オプション5				

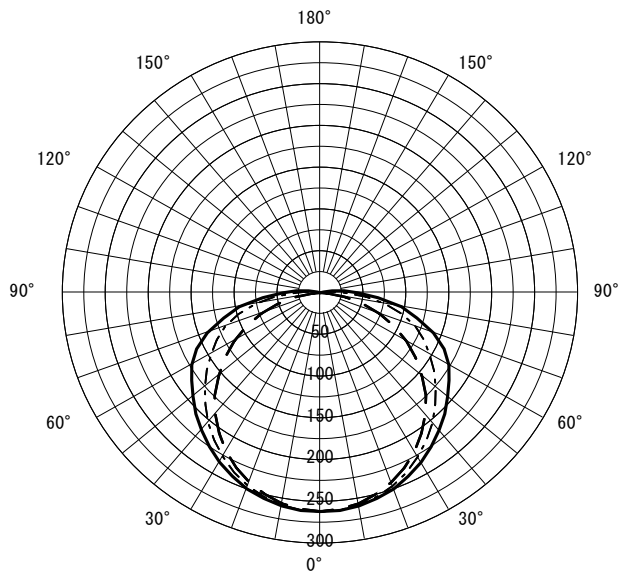

光源		LDL40S-W/17/23-N4		
最大 取付 間隔	高さ	H		
	A-A'	1.3 H		
	B-B'	1.3 H		
器具効率		上方光束	下方光束	計
		1.8%	90.4%	92.2%
保守率		良い	0.830 普通	0.810 悪い
			0.770	

○配光曲線図 (cd/1000lm)



○直射水平面照度 (全光束: 2300 × 2 = 4600lm/台)
照度 (lx) — H1.50m --- H2.00m - - - H2.50m - · - · H3.00m (保守率: 1.00)

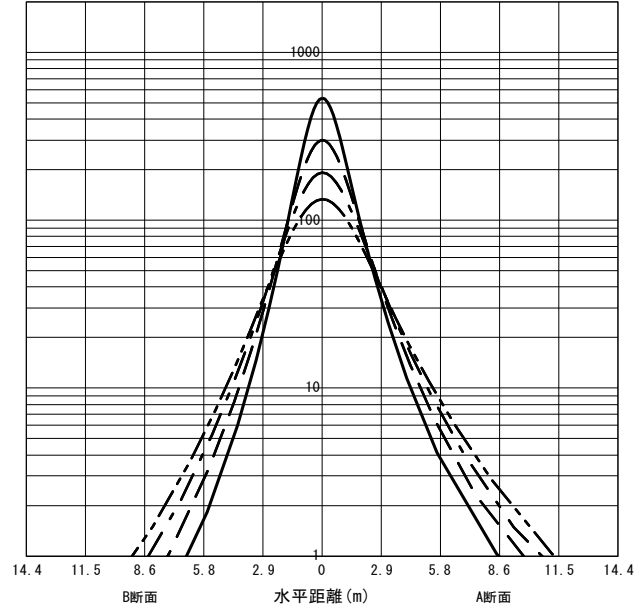

反射率 (%)																																										
天井	80								70								50								30								20	0								
壁	70	50	30	10	70	50	30	10	70	50	30	10	70	50	30	10	70	50	30	10	70	50	30	10	70	50	30	10	10	0												
床	30	10	30	10	30	10	30	10	30	10	30	10	30	10	30	10	30	10	30	10	30	10	30	10	30	10	30	10	30	10	30	10	30	10	30	10	30	10	30	10	10	0
室指数	作業面照明率 (× 0.01)																																									
0.60	54	50	40	38	32	31	26	25	53	49	39	38	31	30	26	25	49	46	38	36	31	30	25	25	46	44	36	35	30	29	25	25	25	23								
0.80	65	59	51	48	42	40	35	34	63	57	50	47	41	39	35	34	59	55	47	45	40	39	34	34	55	52	46	44	39	38	34	33	33	31								
1.00	72	65	58	54	49	47	42	41	70	63	57	53	48	46	42	41	65	60	54	52	47	45	41	40	61	57	52	50	45	44	40	40	39	37								
1.25	79	70	66	61	57	53	50	47	76	69	64	60	56	53	49	47	71	65	61	58	54	51	48	47	66	62	58	56	52	50	47	46	46	43								
1.50	84	74	72	65	63	58	56	53	81	73	70	64	62	58	55	52	75	69	66	62	59	56	53	51	70	66	63	60	57	55	52	51	50	48								
2.00	92	80	81	72	72	66	65	60	88	78	78	71	70	65	64	60	82	75	74	69	67	63	62	59	76	72	70	66	64	62	60	58	58	55								
2.50	97	83	87	77	79	71	72	66	93	81	84	75	77	70	71	65	86	78	79	73	73	68	68	64	80	75	74	71	69	67	65	63	63	60								
3.00	100	86	91	80	84	75	78	70	96	84	88	79	82	74	76	70	89	81	83	76	77	72	73	68	83	78	78	74	73	70	70	67	66	64								
4.00	105	89	97	84	91	80	85	76	100	87	94	83	88	79	83	75	93	84	88	80	83	77	79	74	86	81	82	78	79	75	75	72	72	69								
5.00	107	91	101	87	96	83	91	80	103	89	98	86	93	82	88	79	95	86	91	83	87	80	84	77	89	83	85	81	82	78	79	76	75	73								
7.00	111	93	106	90	102	87	98	85	106	92	102	89	98	86	95	84	98	89	95	86	92	84	89	82	92	86	89	84	87	82	84	80	79	77								
10.00	114	95	110	93	107	91	104	89	109	94	106	91	103	89	100	88	101	91	98	89	96	87	94	86	94	88	92	87	90	85	88	84	83	81								

JIS C 8030:2014

三菱電機照明株式会社