

形名	EL-LKV4321C AHN (39N4)	電源		○諸特性
出力	固定出力	温度		
モード				
オプション1				
オプション2				
オプション3				
オプション4				
オプション5				

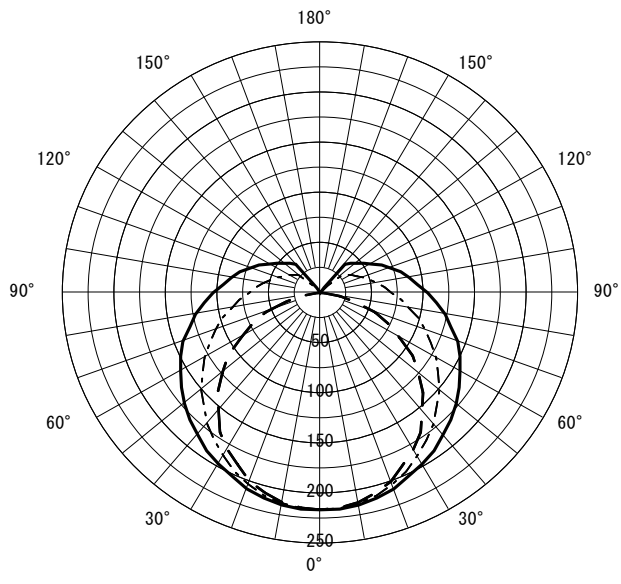

光源		LDL40S-WW/24/34-N4					
最大 取付 間隔	高さ	H					
	A-A'	1.4 H					
	B-B'	1.2 H					
器具効率		上方光束	下方光束	計			
		18.4%	81.5%	99.9%			
保守率		良い	0.880	普通	0.860	悪い	0.810

○配光曲線図 (cd/1000lm)



○直射水平面照度 (全光束: 3400 × 1 = 3400lm/台)  
照度 (lx) — H1.50m --- H2.00m - - - H2.50m - · - · H3.00m (保守率: 1.00)

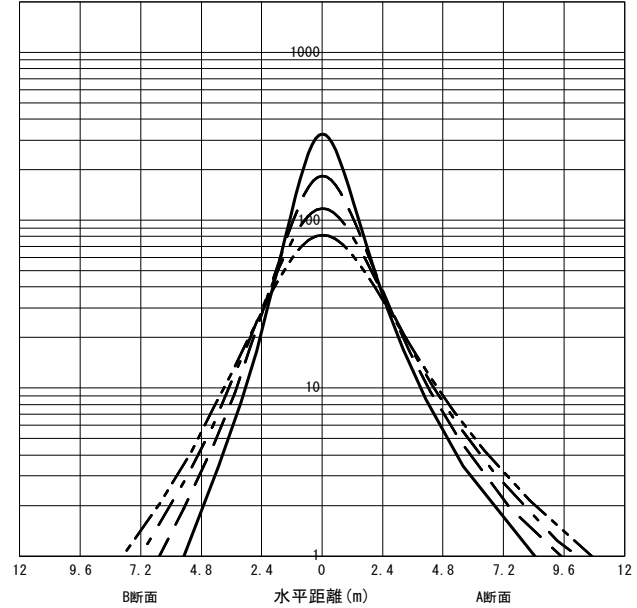

反射率 (%)																																										
天井	80								70								50								30								20	0								
壁	70	50	30	10	70	50	30	10	70	50	30	10	70	50	30	10	70	50	30	10	70	50	30	10	70	50	30	10	10	0												
床	30	10	30	10	30	10	30	10	30	10	30	10	30	10	30	10	30	10	30	10	30	10	30	10	30	10	30	10	30	10	30	10	30	10	30	10	30	10	30	10	10	0
室指数	作業面照明率 (× 0.01)																																									
0.60	56	51	41	39	32	31	25	25	53	49	39	37	31	30	25	24	48	45	36	35	29	28	24	23	43	41	33	32	27	27	22	22	22	19								
0.80	67	60	51	48	42	40	35	34	63	58	49	47	40	39	34	33	57	53	45	43	38	37	32	31	51	48	42	40	35	34	30	30	29	26								
1.00	74	67	59	55	49	47	42	40	70	64	57	53	47	45	41	39	63	58	52	49	44	43	38	37	56	53	48	46	41	40	36	36	35	31								
1.25	82	72	67	62	57	53	49	47	77	69	64	59	55	52	48	46	69	63	59	55	51	49	45	44	62	58	53	51	47	46	42	41	40	36								
1.50	87	77	73	66	63	59	56	52	82	73	70	64	61	57	54	51	73	67	64	60	56	53	50	48	65	61	58	55	52	50	47	46	45	41								
2.00	94	82	82	74	73	66	65	61	89	79	78	71	70	64	63	59	79	72	71	66	64	60	58	56	71	67	64	61	59	57	54	53	51	47								
2.50	99	86	89	78	80	72	73	66	94	82	84	75	76	70	70	65	83	76	76	70	70	65	64	61	74	70	69	65	64	61	59	58	56	51								
3.00	103	88	93	82	85	76	78	71	97	85	89	79	81	74	75	69	86	79	80	73	74	69	69	65	77	72	72	68	68	65	64	61	59	55								
4.00	108	92	100	86	93	81	86	77	102	88	95	83	88	79	83	75	91	82	85	78	80	74	76	71	81	76	76	72	73	69	69	66	64	59								
5.00	111	94	104	89	98	85	92	81	105	91	98	86	93	82	88	79	93	84	88	81	84	77	80	74	83	78	79	75	76	72	73	70	68	63								
7.00	115	97	109	93	104	90	100	86	108	93	103	90	99	87	95	84	96	87	93	84	89	81	86	79	86	81	83	78	81	76	78	74	72	67								
10.00	118	99	114	96	110	93	106	91	111	95	107	93	104	90	101	88	99	89	96	87	94	85	91	83	88	83	86	81	84	80	82	78	76	70								

JIS C 8030:2014

三菱電機照明株式会社