

形名	EL-SC8010WW/4 AHTZ	電源		○諸特性
出力	連調単色	温度		
モード				
オプション1				
オプション2				
オプション3				
オプション4				
オプション5				

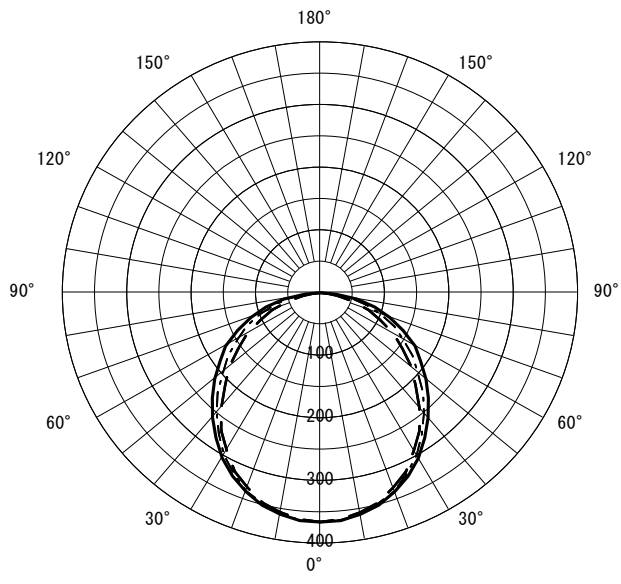

光源		LED					
最大 取付 間隔	高さ	H					
	A-A'	1.2 H					
	B-B'	1.2 H					
器具効率		上方光束	下方光束	計			
		0.0%	100.0%	100.0%			
保守率		良い	0.830	普通	0.810	悪い	0.770

○配光曲線図 (cd/1000lm)



○直射水平面照度 (全光束: 7540 × 1 = 7540lm/台)
照度 (lx) — H1.50m --- H2.00m - - - H2.50m - · - · H3.00m (保守率: 1.00)

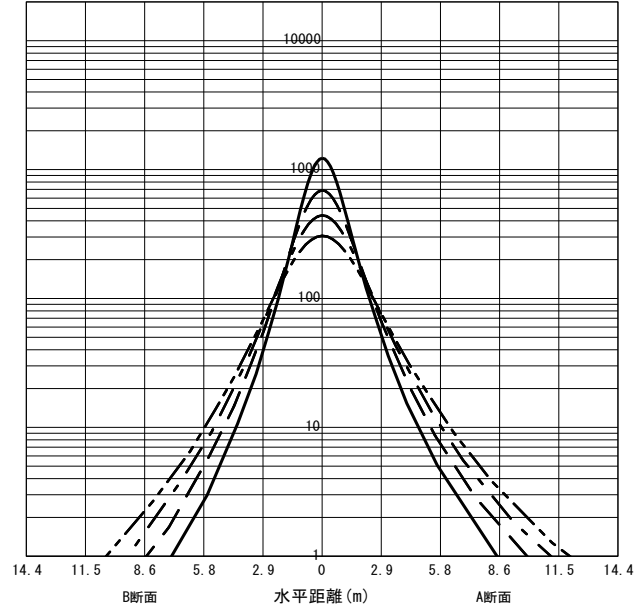

反射率 (%)																																						
天井	80								70								50								30								20	0				
壁	70	50	30	10	70	50	30	10	70	50	30	10	70	50	30	10	70	50	30	10	70	50	30	10	70	50	30	10	10	0								
床	30	10	30	10	30	10	30	10	30	10	30	10	30	10	30	10	30	10	30	10	30	10	30	10	30	10	30	10	30	10	30	10	10	0				
室指数	作業面照明率 (× 0.01)																																					
0.60	63	58	48	46	40	38	34	33	61	57	48	46	39	38	33	33	58	54	46	44	39	38	33	33	55	52	45	43	38	37	33	33	33	31				
0.80	75	68	60	57	51	49	44	43	73	67	59	56	51	49	44	43	69	64	57	55	49	48	44	43	65	61	55	53	48	47	43	43	43	41				
1.00	83	75	69	64	60	57	53	51	80	73	68	63	59	56	52	51	76	70	65	62	57	55	51	50	72	67	63	60	56	54	51	50	50	48				
1.25	91	81	77	71	68	64	61	58	88	79	76	70	67	63	60	58	82	76	72	68	65	62	59	58	78	73	70	67	63	61	58	57	57	55				
1.50	96	85	84	76	75	69	68	64	93	83	82	75	73	69	67	63	87	80	78	73	71	67	65	63	82	77	75	71	69	66	64	62	62	60				
2.00	104	90	93	83	84	77	78	72	100	89	90	82	83	76	77	72	94	85	86	80	80	75	74	71	88	83	82	78	77	74	72	70	70	68				
2.50	108	94	99	87	91	82	85	78	105	92	96	86	89	81	83	77	98	89	91	84	85	80	81	76	92	86	86	82	82	79	78	75	75	73				
3.00	112	96	104	91	97	86	91	82	108	94	100	89	94	85	89	81	101	92	95	87	90	84	85	80	95	89	90	85	86	82	82	79	79	77				
4.00	117	99	110	95	104	91	99	88	112	98	106	94	101	90	96	87	105	95	100	91	96	88	92	86	98	92	94	89	91	87	88	84	84	82				
5.00	119	101	114	97	108	94	104	91	115	100	110	96	105	93	101	91	107	97	103	94	100	91	96	89	100	94	97	92	94	90	92	88	87	85				
7.00	123	103	118	101	114	98	111	96	118	102	114	99	111	97	107	95	110	99	107	97	104	95	102	93	103	97	101	95	98	93	96	92	91	89				
10.00	125	105	122	103	119	101	116	99	121	103	118	102	115	100	113	98	112	101	110	99	108	98	106	97	105	98	103	97	102	96	100	95	94	92				

JIS C 8030:2014

三菱電機照明株式会社