

形名	EL-SK4010L/3 AHTZ	電源		○諸特性
出力	段調光	温度		
モード	定格			
オプション1				
オプション2				
オプション3				
オプション4				
オプション5				

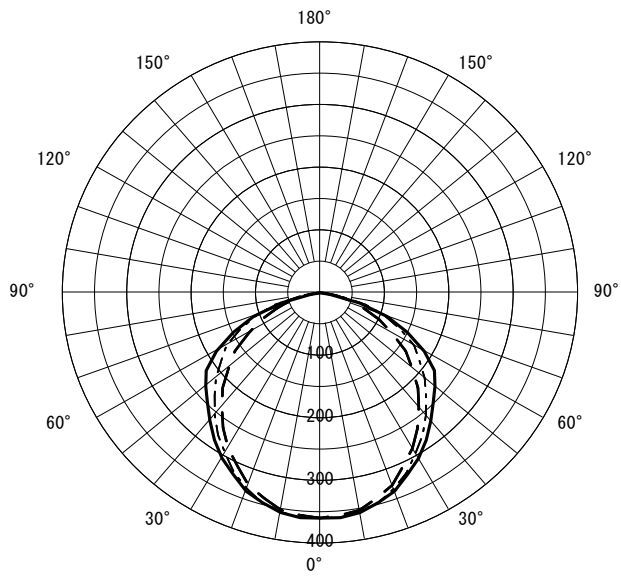

光源		LED					
最大 取付 間隔	高さ	H					
	A-A'	1.3 H					
	B-B'	1.2 H					
器具効率		上方光束	下方光束	計			
		0.0%	100.0%	100.0%			
保守率		良い	0.830	普通	0.810	悪い	0.770

○配光曲線図 (cd/1000lm)



○直射水平面照度 (全光束: 3500 × 1 = 3500lm/台)  
照度 (lx) — H1.50m --- H2.00m - - - H2.50m - · - · H3.00m (保守率: 1.00)

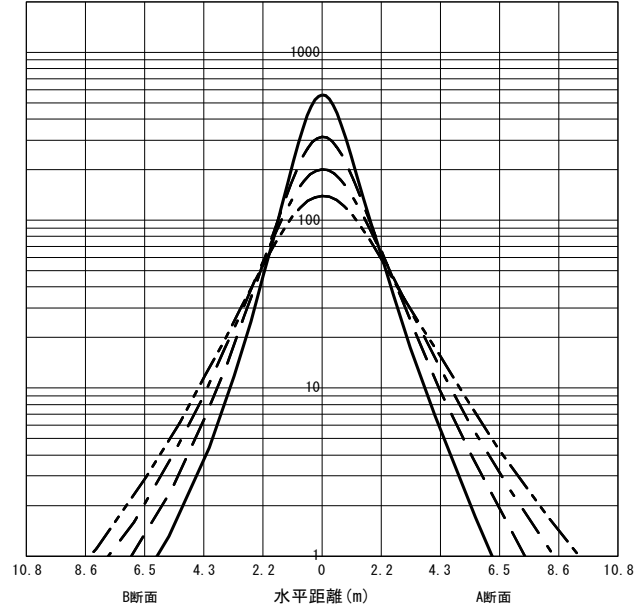

反射率 (%)																																							
天井	80								70								50								30								20	0					
壁	70	50	30	10	70	50	30	10	70	50	30	10	70	50	30	10	70	50	30	10	70	50	30	10	70	50	30	10	10	0									
床	30	10	30	10	30	10	30	10	30	10	30	10	30	10	30	10	30	10	30	10	30	10	30	10	30	10	30	10	30	10	30	10	10	0					
室指数	作業面照明率 (× 0.01)																																						
0.60	63	58	48	46	39	38	33	33	61	57	47	45	39	38	33	33	58	54	46	44	38	37	33	33	55	52	45	43	38	37	33	32	32	31					
0.80	75	68	60	57	51	49	45	43	73	67	59	56	51	49	44	43	69	64	57	55	50	48	44	43	65	61	55	53	49	47	43	43	43	41					
1.00	83	75	69	64	60	57	53	51	81	73	68	64	59	56	53	51	76	70	65	62	58	56	52	51	72	68	63	60	56	55	51	50	50	48					
1.25	91	81	78	71	69	64	62	59	88	79	76	71	68	64	61	59	83	76	73	69	66	63	60	58	78	74	70	67	64	62	59	58	57	55					
1.50	97	85	84	77	75	70	68	65	93	83	82	76	74	69	68	64	88	80	79	74	72	68	66	64	83	78	75	72	69	67	65	63	63	61					
2.00	104	91	94	84	85	78	79	73	101	89	91	83	84	77	78	73	94	86	87	81	81	76	75	72	89	83	83	79	78	75	73	71	71	69					
2.50	109	94	100	88	93	83	86	79	105	93	97	87	90	82	85	78	99	90	92	85	87	81	82	77	93	87	87	83	83	80	79	77	76	74					
3.00	113	97	105	91	98	87	92	83	109	95	101	90	95	86	90	83	102	92	96	88	91	85	87	82	95	90	91	86	87	83	83	80	80	78					
4.00	117	100	111	96	105	92	100	89	113	98	107	95	102	91	98	88	105	95	101	92	97	89	93	87	99	93	95	90	92	88	89	86	85	83					
5.00	120	101	114	98	109	95	105	92	116	100	111	97	106	94	102	92	108	97	104	95	101	92	97	90	101	95	98	93	95	91	93	89	88	86					
7.00	123	104	119	101	115	99	112	97	119	102	115	100	112	98	108	96	111	100	108	98	105	96	103	94	104	97	101	96	99	94	97	93	92	90					
10.00	126	105	123	103	120	102	117	100	121	104	118	102	116	101	113	99	113	101	111	100	109	99	107	97	105	99	104	98	102	97	101	96	95	93					

JIS C 8030:2014

三菱電機照明株式会社