

形名	EL-SK4010L/4 AHTZ	電源		○諸特性
出力	段調光	温度		
モード	定格			
オプション1				
オプション2				
オプション3				
オプション4				
オプション5				

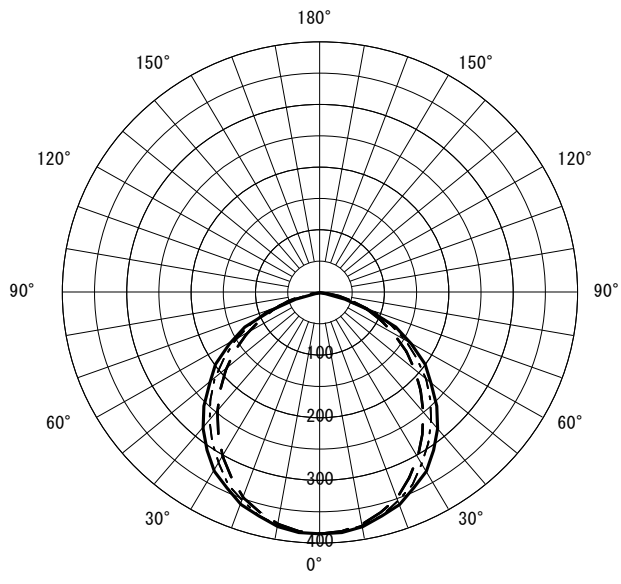

光源		LED					
最大 取付 間隔	高さ	H					
	A-A'	1.3 H					
	B-B'	1.2 H					
器具効率		上方光束	下方光束	計			
		0.0%	100.0%	100.0%			
保守率		良い	0.830	普通	0.810	悪い	0.770

○配光曲線図 (cd/1000lm)



○直射水平面照度 (全光束: 3850 × 1 = 3850lm/台)
照度 (lx) — H1.50m --- H2.00m - - - H2.50m - · - · H3.00m (保守率: 1.00)

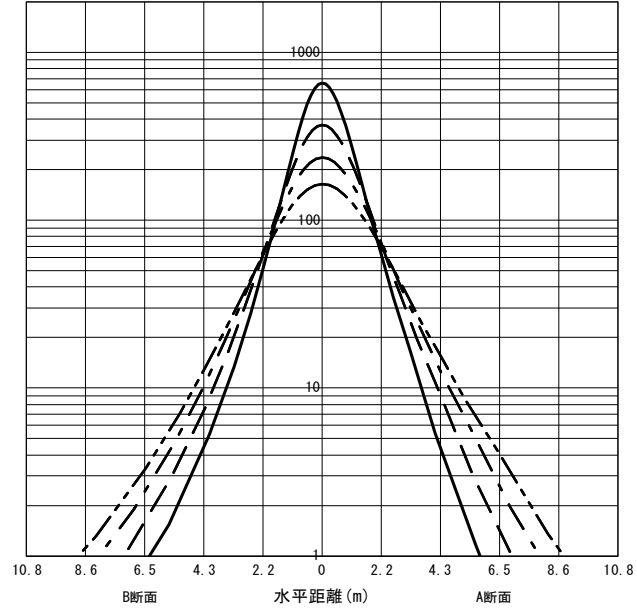

反射率 (%)																																							
天井	80								70								50								30								20	0					
壁	70	50	30	10	70	50	30	10	70	50	30	10	70	50	30	10	70	50	30	10	70	50	30	10	70	50	30	10	10	0									
床	30	10	30	10	30	10	30	10	30	10	30	10	30	10	30	10	30	10	30	10	30	10	30	10	30	10	30	10	30	10	30	10	10	0					
室指数	作業面照明率 (× 0.01)																																						
0.60	64	59	50	47	41	40	35	35	63	58	49	47	41	40	35	35	59	56	48	46	40	39	35	35	57	54	46	45	40	39	35	34	34	33					
0.80	76	69	62	59	53	51	47	46	74	68	61	58	53	51	47	46	70	65	59	57	52	50	46	45	67	63	57	55	51	49	46	45	45	43					
1.00	85	76	71	66	62	59	55	53	82	75	70	65	61	58	55	53	78	72	67	64	60	58	54	53	74	69	65	62	58	57	53	53	52	51					
1.25	92	82	80	73	71	66	64	61	90	81	78	72	70	66	63	61	84	78	75	71	68	65	62	60	80	75	72	69	66	64	61	60	60	58					
1.50	98	86	86	78	77	72	71	67	95	85	84	77	76	71	70	66	89	82	80	75	74	70	68	66	84	79	77	74	71	69	67	65	65	63					
2.00	105	92	95	85	87	80	81	75	102	90	93	84	86	79	80	75	96	87	88	82	82	78	77	74	90	85	84	80	79	76	75	73	73	71					
2.50	110	95	101	89	94	85	88	81	106	94	98	88	92	84	87	80	100	91	93	86	88	82	84	79	94	88	89	84	85	81	81	78	78	76					
3.00	114	97	106	92	99	88	94	85	110	96	103	91	97	88	92	84	102	93	97	89	92	86	88	83	96	90	92	87	88	84	85	82	81	79					
4.00	118	100	111	96	106	93	101	90	114	99	108	95	103	92	99	89	106	96	102	93	98	90	94	88	100	94	96	91	93	89	90	87	86	84					
5.00	120	102	115	99	110	96	106	93	116	101	111	98	107	95	104	93	108	98	105	95	101	93	99	91	102	95	99	93	96	92	94	90	89	87					
7.00	124	104	120	102	116	99	112	97	119	103	116	100	112	98	109	97	111	100	108	98	106	97	103	95	104	98	102	96	100	95	98	93	93	91					
10.00	126	105	123	104	120	102	118	101	121	104	119	103	116	101	114	100	113	102	111	100	109	99	107	98	106	99	104	98	103	97	101	96	95	93					

JIS C 8030:2014

三菱電機照明株式会社