

形名	EL-SL20012L/W 1HN	電源		○諸特性
出力	固定出力	温度		
モード	定格			
オプション1	EL-X112			
オプション2				
オプション3				
オプション4				
オプション5				

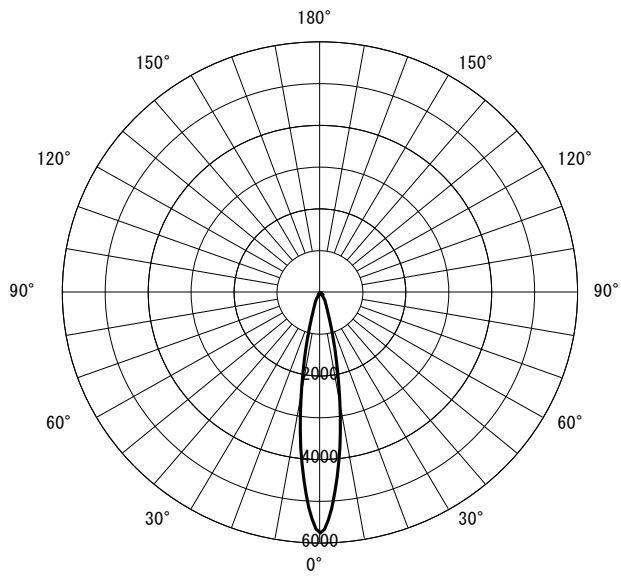

光源		LED					
最大 取付 間隔	高さ	H					
	A-A'	0.3 H					
	B-B'	0.3 H					
器具効率		上方光束	下方光束	計			
		0.0%	100.0%	100.0%			
保守率		良い	0.670	普通	0.630	悪い	0.560

○配光曲線図 (cd/1000lm)



○直射水平面照度 (全光束: 1400 × 1 = 1400lm/台)

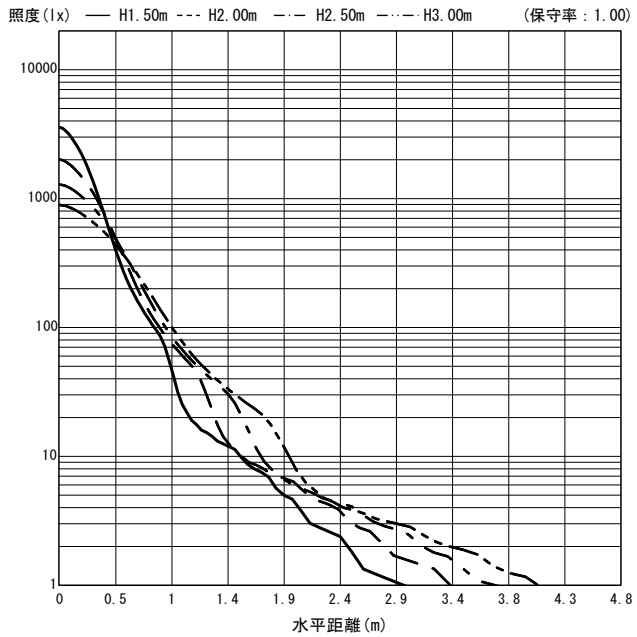

反射率 (%)																																		
天井	80				70				50				30				20	0																
壁	70	50	30	10	70	50	30	10	70	50	30	10	70	50	30	10	70	50	30	10	10	0												
床	30	10	30	10	30	10	30	10	30	10	30	10	30	10	30	10	30	10	30	10	30	10	30	10	30	10	30	10	30	10	10	0		
室指数	作業面照明率 (× 0.01)																																	
0.60	97	89	88	84	83	81	80	79	96	89	88	84	83	81	80	79	93	88	87	83	82	80	79	78	91	86	85	83	82	80	79	78	78	77
0.80	104	94	95	89	90	86	86	84	102	93	94	89	89	86	86	84	99	92	92	88	88	85	85	83	96	91	91	87	87	85	84	83	83	82
1.00	108	97	100	93	94	90	90	87	106	96	99	92	94	89	90	87	102	95	96	91	92	89	89	87	99	93	94	90	90	88	88	86	86	85
1.25	112	99	104	96	99	93	95	91	110	99	103	95	98	92	94	90	105	97	100	94	96	92	93	90	101	95	97	93	94	91	91	89	89	88
1.50	115	101	108	98	103	95	99	93	112	100	106	97	101	95	97	93	107	98	102	96	98	94	95	92	103	97	99	95	96	93	93	91	91	90
2.00	119	103	113	101	108	98	104	96	116	102	110	100	106	98	102	96	110	100	106	98	102	97	100	95	105	99	102	97	99	95	97	94	94	92
2.50	121	105	116	102	111	100	108	98	118	104	113	101	109	100	106	98	112	102	108	100	105	98	102	97	106	100	103	98	101	97	99	96	95	94
3.00	123	106	118	103	114	102	111	100	119	104	115	103	112	101	109	99	113	102	110	101	107	100	105	98	107	101	105	99	103	98	101	97	97	95
4.00	125	107	121	105	118	104	115	102	121	106	118	104	115	103	112	102	114	103	112	102	109	101	107	100	108	102	106	101	105	100	103	99	98	97
5.00	127	107	123	106	120	105	118	104	123	106	120	105	117	104	115	103	115	104	113	103	111	102	109	101	109	102	107	101	106	101	104	100	99	97
7.00	129	108	126	107	124	106	121	105	124	107	122	106	120	105	118	104	116	105	115	104	113	103	112	103	109	103	108	102	107	102	106	101	100	99
10.00	130	109	128	108	126	107	125	107	125	107	124	107	122	106	121	106	117	105	116	105	115	104	114	104	110	103	109	103	108	102	108	102	101	99

JIS C 8030:2014

三菱電機照明株式会社