

形名	EL-SL30022WW/K 1HTN	電源		○諸特性
出力	段調光	温度		
モード	定格			
オプション1	EL-X110K			
オプション2				
オプション3				
オプション4				
オプション5				

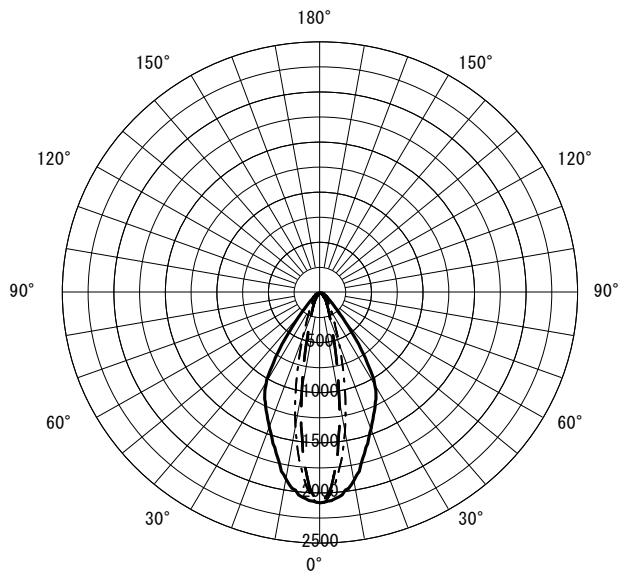

光源		LED					
最大 取付 間隔	高さ	H					
	A-A'	0.8 H					
	B-B'	0.3 H					
器具効率		上方光束	下方光束	計			
		0.0%	100.0%	100.0%			
保守率		良い	0.670	普通	0.630	悪い	0.560

○配光曲線図 (cd/1000lm)



○直射水平面照度 (全光束: 2945 × 1 = 2945lm/台)
照度 (lx) — H1.50m --- H2.00m - - - H2.50m - · - · H3.00m (保守率: 1.00)

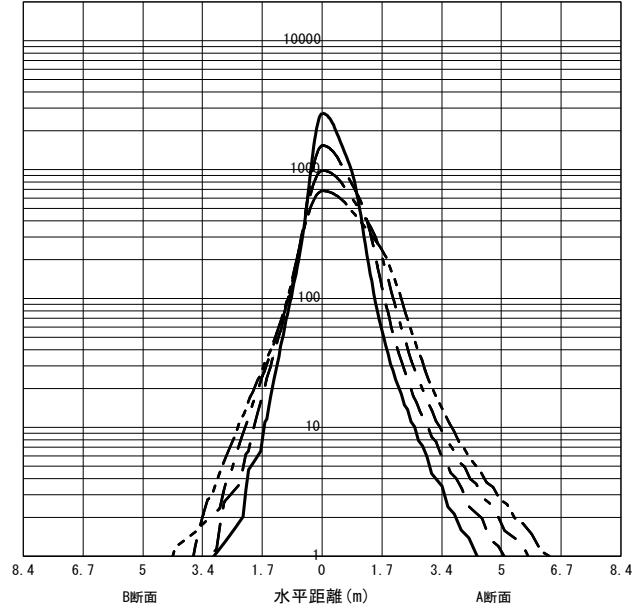

反射率 (%)																																		
天井	80				70				50				30				20	0																
壁	70	50	30	10	70	50	30	10	70	50	30	10	70	50	30	10	70	50	30	10	10	0												
床	30	10	30	10	30	10	30	10	30	10	30	10	30	10	30	10	30	10	30	10	30	10	30	10	10	0								
室指数	作業面照明率 (× 0.01)																																	
0.60	84	78	73	70	67	65	62	62	83	77	73	69	67	65	62	61	80	75	71	69	66	64	62	61	78	74	70	68	65	64	62	61	61	60
0.80	94	85	83	78	77	74	72	70	92	84	82	78	76	73	72	70	88	82	80	77	75	73	71	70	85	81	79	76	74	72	70	70	69	68
1.00	100	90	90	84	84	79	79	76	98	89	89	83	83	79	78	76	94	87	86	82	81	78	77	75	90	85	84	81	80	78	76	75	75	74
1.25	105	94	96	88	90	84	85	81	103	93	95	88	89	84	84	81	98	91	92	86	87	83	83	80	94	89	89	85	85	82	81	80	80	78
1.50	109	96	101	92	95	88	90	85	107	95	99	91	93	87	89	85	101	93	95	89	91	86	87	84	97	91	92	88	88	86	85	83	83	82
2.00	114	100	107	96	102	93	97	90	111	98	105	95	100	92	96	90	105	96	100	93	96	91	93	89	100	94	96	92	93	90	90	88	87	86
2.50	118	102	111	98	106	96	102	93	114	100	109	97	104	95	100	93	108	98	104	96	100	94	97	92	102	96	99	94	96	92	94	91	90	89
3.00	120	103	114	100	110	98	106	96	116	102	111	99	107	97	104	95	110	99	106	97	103	96	100	94	104	97	101	96	98	94	96	93	92	91
4.00	123	104	118	102	114	100	111	99	119	103	115	101	111	100	108	98	112	101	109	99	106	98	104	97	105	99	103	98	101	96	99	95	95	93
5.00	125	105	121	104	117	102	114	101	120	104	117	103	114	101	111	100	113	102	110	101	108	99	106	98	106	100	105	99	103	98	101	97	96	94
7.00	127	106	124	105	121	104	119	103	122	105	120	104	117	103	115	102	114	103	113	102	111	101	109	100	108	101	106	100	105	99	104	99	98	96
10.00	128	107	126	106	124	105	122	105	124	106	122	105	120	104	118	104	115	104	114	103	113	102	112	102	108	102	107	101	106	101	106	100	99	97

JIS C 8030:2014

三菱電機照明株式会社