

形名	EL-VE1713C	電源		○諸特性
出力	固定出力	温度		
モード				
オプション1				
オプション2				
オプション3				
オプション4				
オプション5				

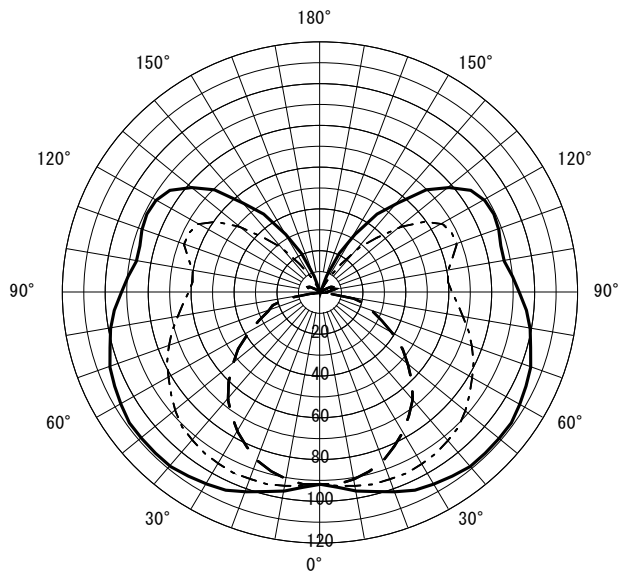

光源		LDA7L-G-E17/60/S					
最大 取付 間隔	高さ	H					
	A-A'	1.8 H					
	B-B'	1.3 H					
器具効率		上方光束	下方光束	計			
		26.4%	48.3%	74.7%			
保守率		良い	0.630	普通	0.590	悪い	0.560

○配光曲線図 (cd/1000lm)



○直射水平面照度 (全光束 : 760 × 2 = 1520lm/台)
照度 (lx) — H1.50m --- H2.00m - - - H2.50m - · - · H3.00m (保守率 : 1.00)

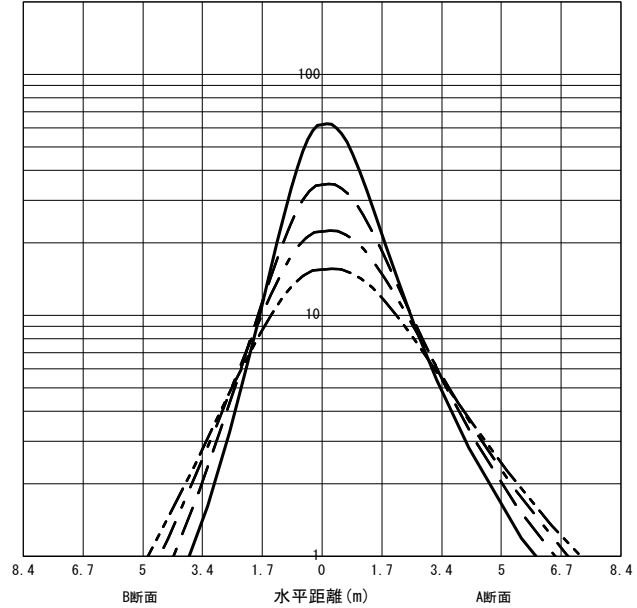

反射率 (%)																																		
天井	80				70				50				30				20	0																
壁	70	50	30	10	70	50	30	10	70	50	30	10	70	50	30	10	70	50	30	10	10	0												
床	30	10	30	10	30	10	30	10	30	10	30	10	30	10	30	10	30	10	30	10	30	10	30	10	30	10	30	10	30	10	10	0		
室指数	作業面照明率 (× 0.01)																																	
0.60	39	36	28	26	21	20	16	16	36	33	26	25	20	19	15	15	31	29	23	22	17	17	14	14	26	25	20	19	15	15	12	12	11	9
0.80	46	42	35	33	28	27	23	22	43	39	33	31	26	25	21	21	37	34	29	27	23	23	19	19	31	29	25	24	20	20	17	17	16	13
1.00	52	47	41	38	33	31	28	27	48	44	38	36	31	30	26	25	41	38	33	31	28	27	23	23	34	33	29	27	24	23	21	20	19	16
1.25	57	51	46	43	39	36	33	32	53	48	43	40	36	34	31	30	45	41	38	35	32	31	28	27	38	36	32	31	28	27	24	24	23	19
1.50	61	54	51	46	43	40	38	35	56	50	47	44	41	38	35	34	48	44	41	38	36	34	31	30	40	38	35	34	31	30	28	27	25	21
2.00	67	58	58	51	50	46	45	41	62	54	54	48	47	44	42	39	52	48	46	43	41	39	37	35	44	41	39	37	36	34	32	31	30	25
2.50	71	61	62	55	56	50	50	46	65	57	58	52	52	47	47	43	55	50	50	46	45	42	41	39	46	44	42	40	39	37	36	35	33	28
3.00	73	63	66	58	59	53	54	49	68	59	61	54	56	50	51	47	57	52	52	48	48	45	44	42	48	45	45	42	41	40	39	37	35	30
4.00	77	65	71	61	65	57	60	54	71	62	65	58	61	54	56	51	60	54	56	51	52	48	49	46	51	48	48	45	45	43	43	41	38	33
5.00	79	67	74	63	69	60	65	57	73	63	68	60	64	57	60	54	62	56	59	53	55	51	52	49	52	49	50	47	47	45	45	43	41	35
7.00	82	69	78	66	74	63	70	61	76	65	72	63	69	60	66	58	64	58	62	56	59	54	57	52	54	51	52	49	51	48	49	46	44	38
10.00	85	71	81	69	78	66	75	64	78	67	75	65	73	63	70	61	66	60	64	58	62	57	60	55	56	53	55	51	53	50	52	49	46	40

JIS C 8030:2014

三菱電機照明株式会社