

形名	MY-B425337/N VCTZ	電源		○諸特性
出力	段調光	温度		
モード	定格			
オプション1				
オプション2				
オプション3				
オプション4				
オプション5				

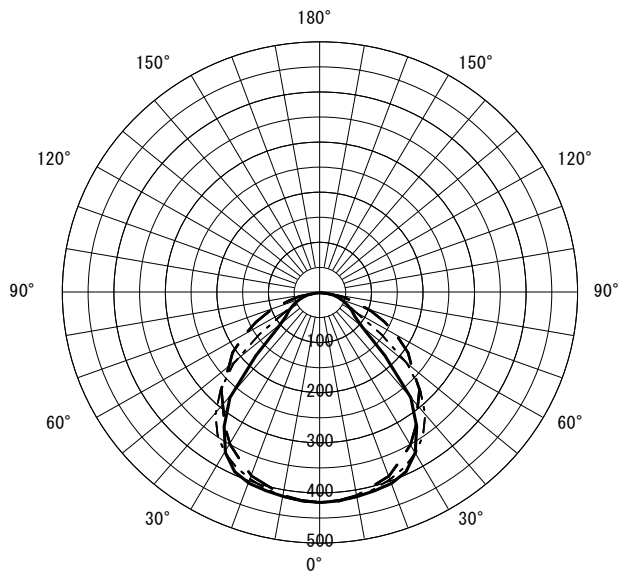

光源		LED					
最大 取付 間隔	高さ	H					
	A-A'	1.3 H					
	B-B'	1.2 H					
器具効率		上方光束	下方光束	計			
		0.0%	100.0%	100.0%			
保守率		良い	0.810	普通	0.770	悪い	0.680

○配光曲線図 (cd/1000lm)



○直射水平面照度 (全光束: 2320 × 1 = 2320lm/台)  
照度 (lx) — H1.50m --- H2.00m - - - H2.50m - · - · H3.00m (保守率: 1.00)

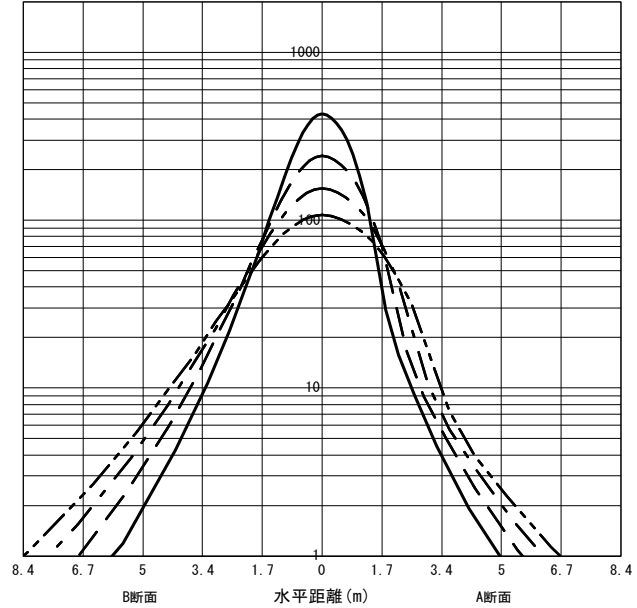

反射率 (%)																																		
天井	80								70								50								30								20	0
壁	70	50	30	10	70	50	30	10	70	50	30	10	70	50	30	10	70	50	30	10	70	50	30	10	70	50	30	10	10	0				
床	30	10	30	10	30	10	30	10	30	10	30	10	30	10	30	10	30	10	30	10	30	10	30	10	30	10	30	10	30	10	30	10	10	0
室指数	作業面照明率 (× 0.01)																																	
0.60	67	62	53	51	45	44	39	39	65	61	52	50	44	43	39	38	62	58	51	49	44	43	39	38	60	56	50	48	43	42	38	38	38	36
0.80	79	72	66	62	57	55	51	50	77	71	65	61	57	55	51	50	73	68	63	60	56	54	50	49	70	66	61	59	55	53	50	49	49	47
1.00	88	79	75	69	66	63	60	58	85	77	73	69	65	62	59	57	80	75	71	67	64	61	58	57	77	72	68	66	62	61	58	57	56	55
1.25	95	84	83	76	74	70	68	65	92	83	81	75	73	69	67	65	87	80	78	73	71	68	66	64	82	78	75	72	69	67	65	64	63	61
1.50	100	88	89	80	80	75	74	70	97	86	87	80	79	74	73	70	91	84	83	78	77	73	72	69	86	81	80	76	74	72	70	68	68	66
2.00	107	93	97	87	90	82	84	77	103	91	95	86	88	81	82	77	97	89	90	84	85	80	80	76	92	86	86	82	82	78	78	75	75	73
2.50	111	96	103	91	96	86	90	82	107	95	100	90	94	86	89	82	101	92	95	88	90	84	86	81	95	89	90	86	86	83	83	80	80	78
3.00	114	98	107	93	101	90	95	86	110	97	104	92	98	89	93	86	103	94	98	90	94	87	90	84	97	91	93	88	90	86	86	83	83	81
4.00	118	101	112	97	107	94	102	91	114	99	109	96	104	93	100	90	107	97	103	94	99	91	96	89	100	94	97	92	94	90	92	88	87	85
5.00	121	102	116	99	111	97	107	94	117	101	112	98	108	96	104	93	109	98	105	96	102	94	99	92	102	96	100	94	97	92	95	91	90	88
7.00	124	104	120	102	116	100	113	98	119	103	116	101	113	99	110	97	111	100	109	99	106	97	104	96	104	98	102	97	100	95	99	94	93	91
10.00	126	105	123	104	121	102	118	101	121	104	119	103	117	101	114	100	113	102	111	101	109	99	108	98	106	99	105	98	103	97	102	97	96	94

JIS C 8030:2014

三菱電機照明株式会社