

SKU-65AC

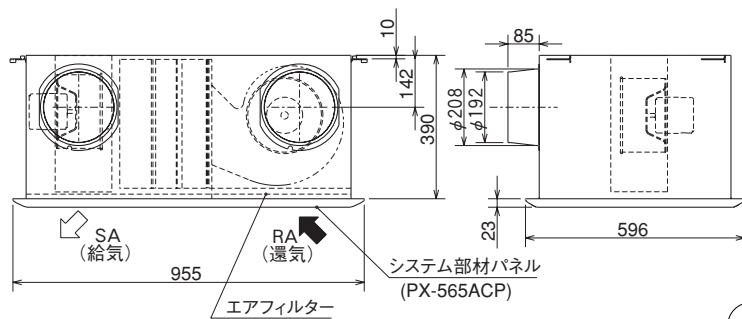
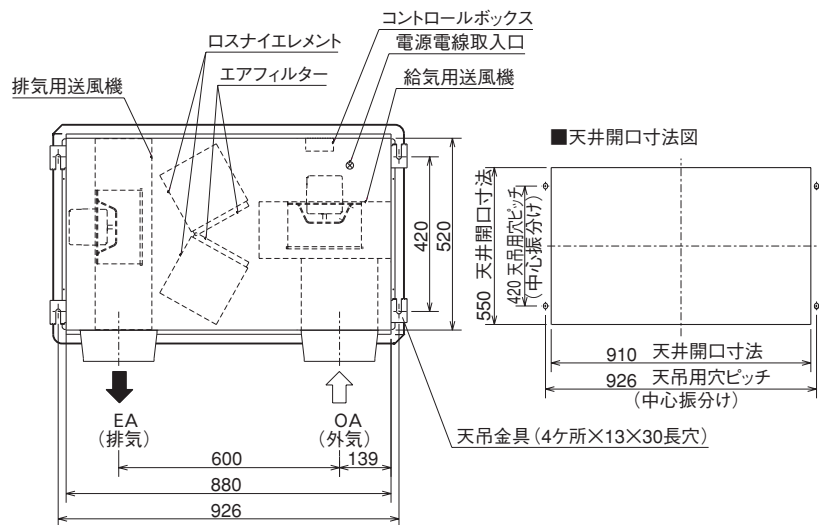

ダクト径
φ200
 (単位mm)