

高压用

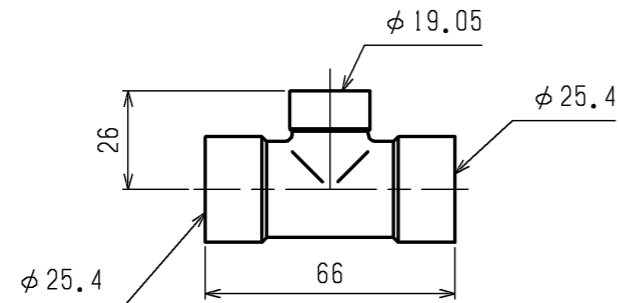

低压用

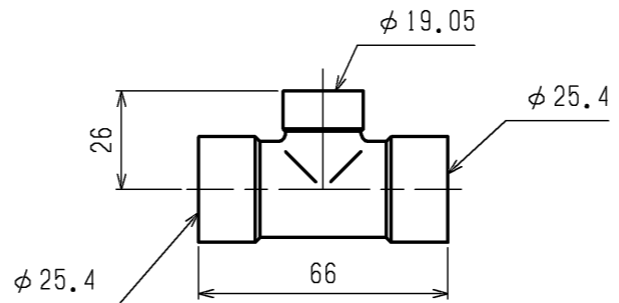

液用

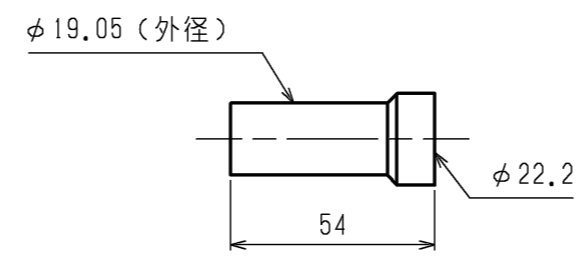
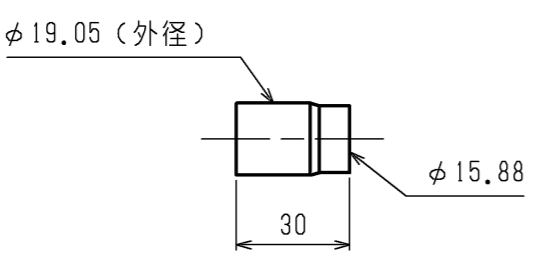
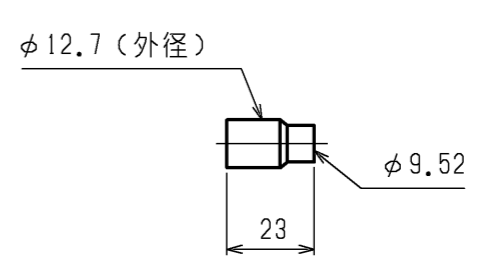
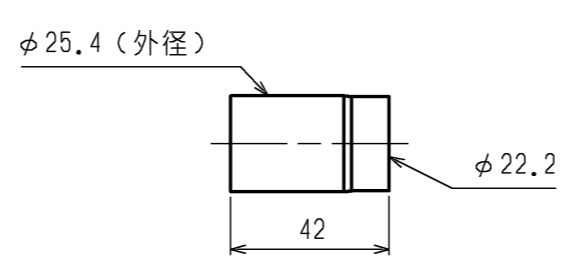
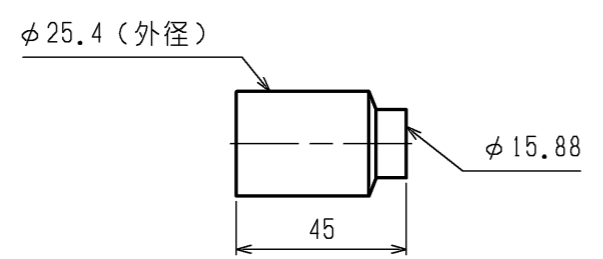
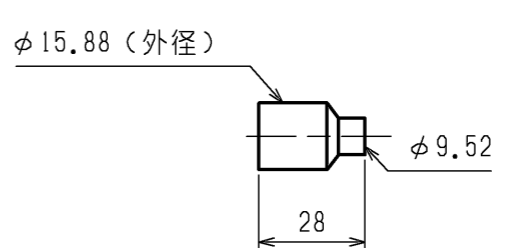
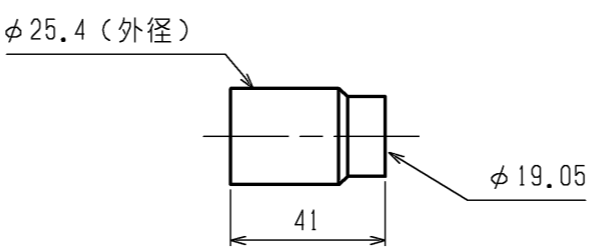
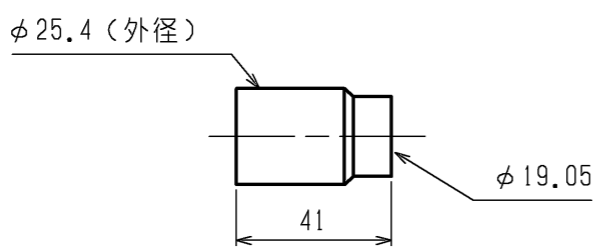
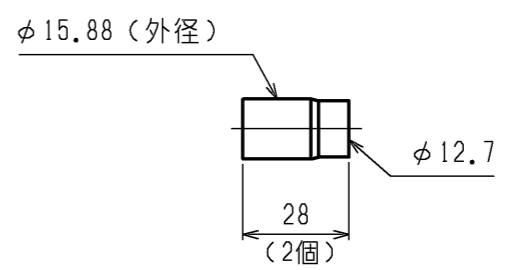
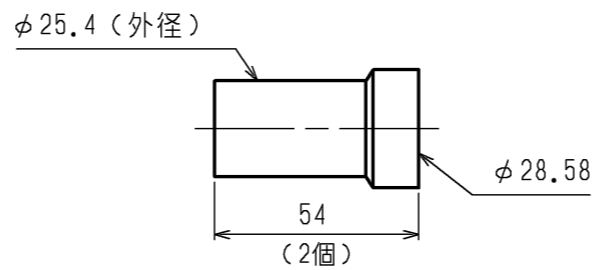
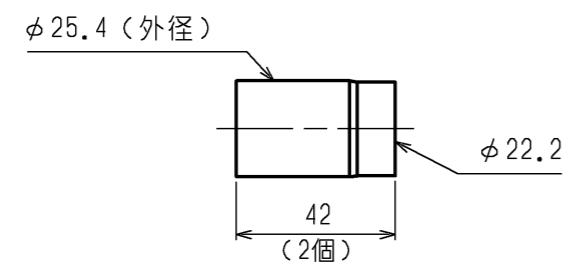
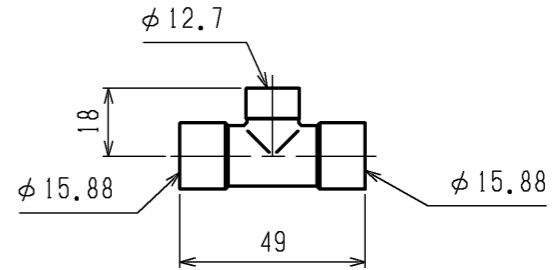

< 付属品 >
 ・断熱カバー 3個

注. 管端加工部に示している配管径は、内径を表示しています。

	作成日付 ISSUED	改定日付 REVISED	TITLE		
	DIM. mm	17-06-15	CMY-R202DG5 シティマルチ R2シリーズ 別売品 分岐管セット 外形図		
SCALE NTS	三菱電機株式会社		DRW.NO.	REV.	PAGE
			W KL94G650	*	1/1