

高压用

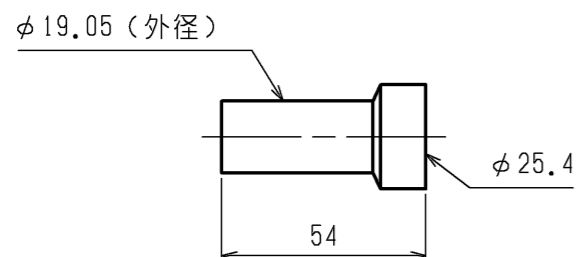

低压用

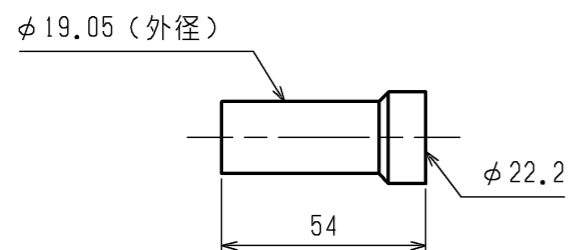
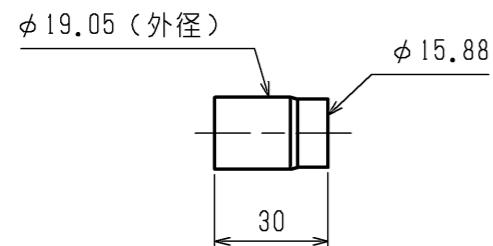
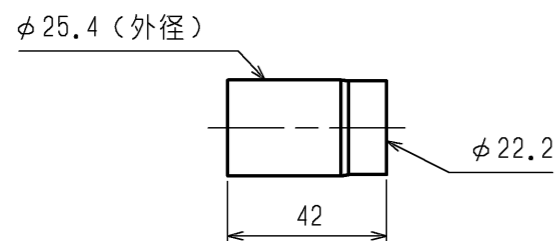
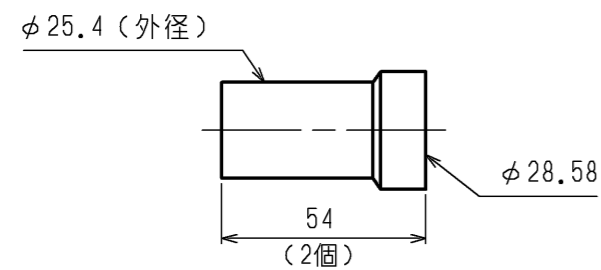
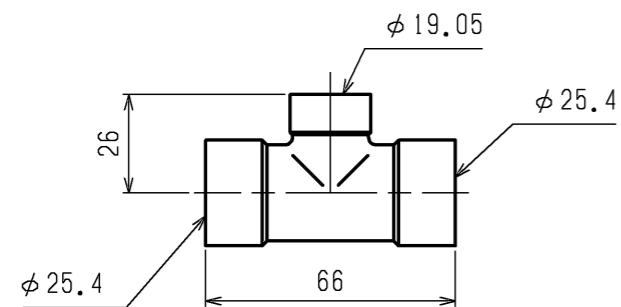
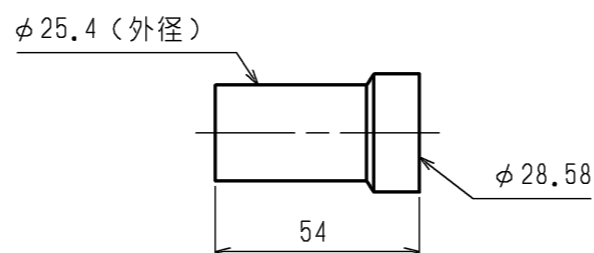
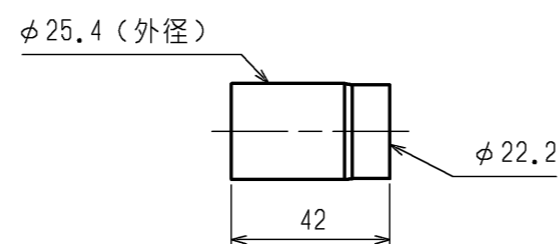
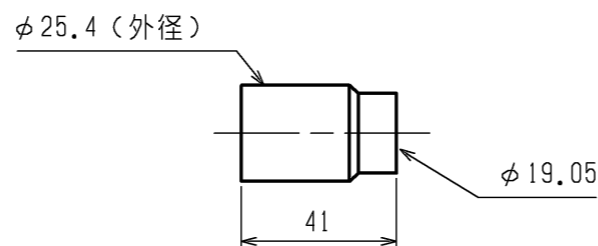
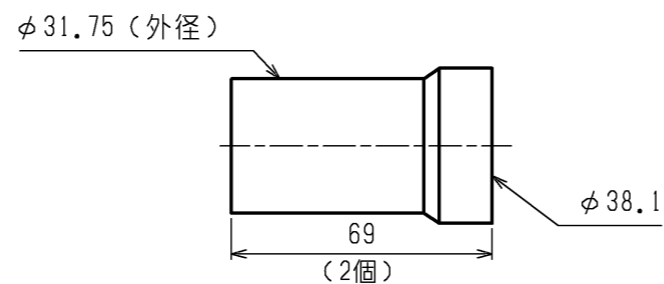
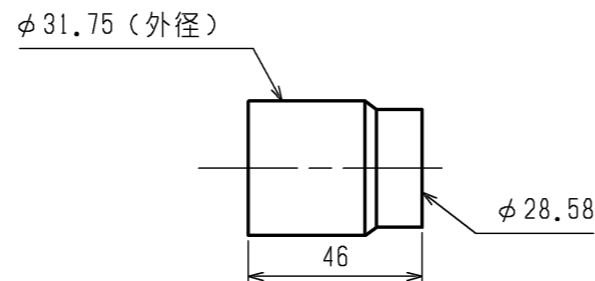
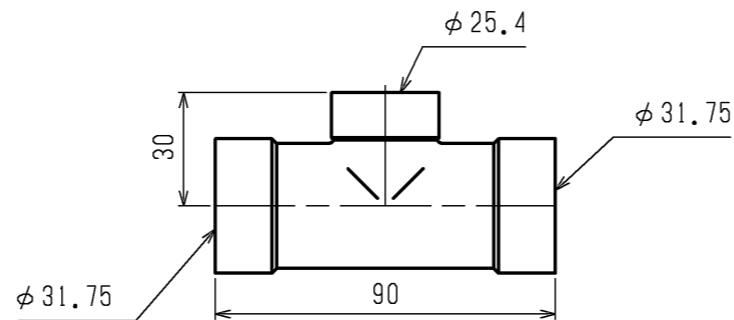

液用

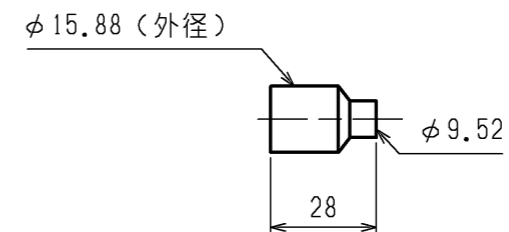
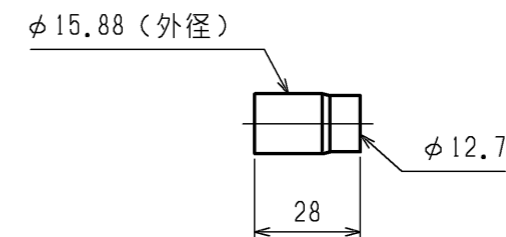
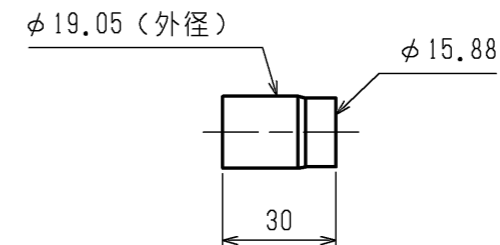
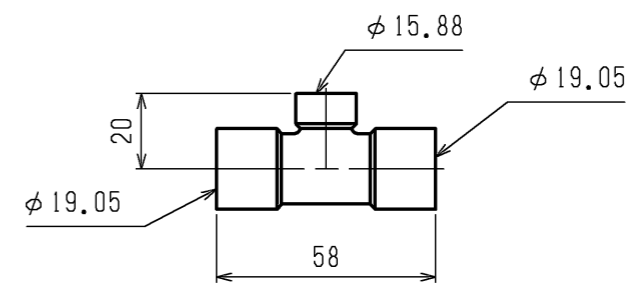

<付属品>  
・断熱カバー・・・・・・・・・・3個

注. 管端加工部に示している配管径は、内径を表示しています。

	作成日付 ISSUED	改定日付 REVISED	TITLE		
	DIM. mm	17-06-15	CMY-R204DG5 シティマルチ R2シリーズ 別売品 分岐管セット 外形図		
SCALE NTS	三菱電機株式会社		DRW.NO. W KL94G652	REV. *	PAGE 1/1