

ガス管用

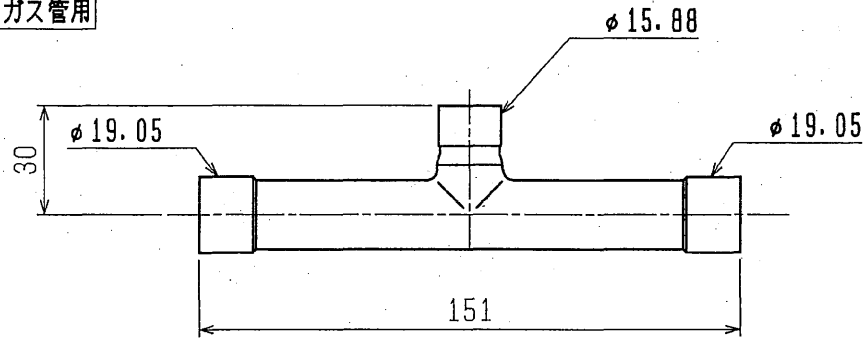

液管用

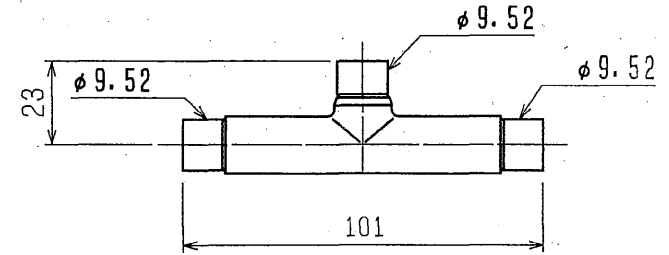

<異径管(付属品)>

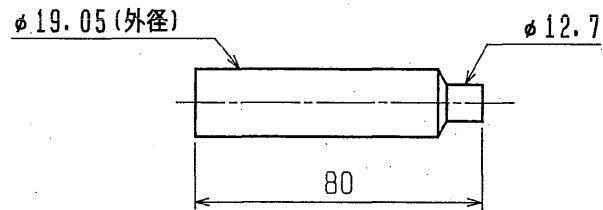
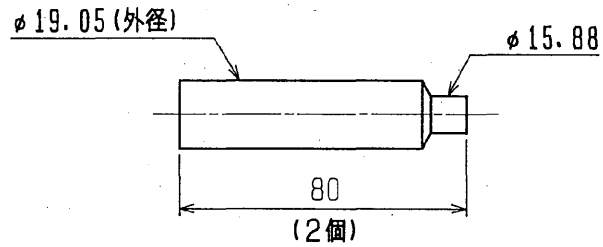
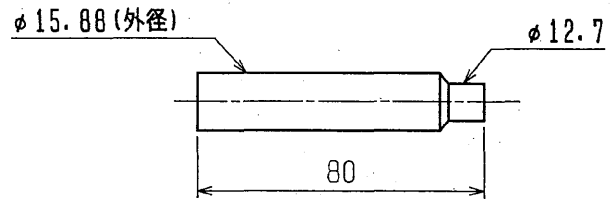

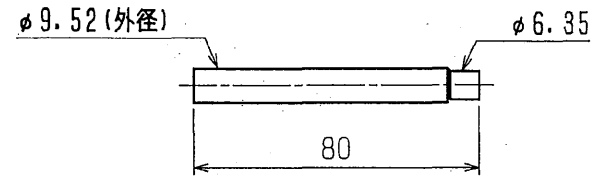

<異径管(付属品)>

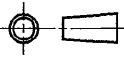

(2個)

注1. 配管径は内径で表示しています。

 DIM. mm	作成日付 ISSUED	改定日付 REVISED	TITLE 三菱エアコン 別売品 分岐ジョイント 外形図 CMY-Y102S-D
	2003-12-04	2003-12-11	
SCALE 1:2	 三菱電機株式会社		DRW. NO. W901606 REV. A PAGE 1/1