

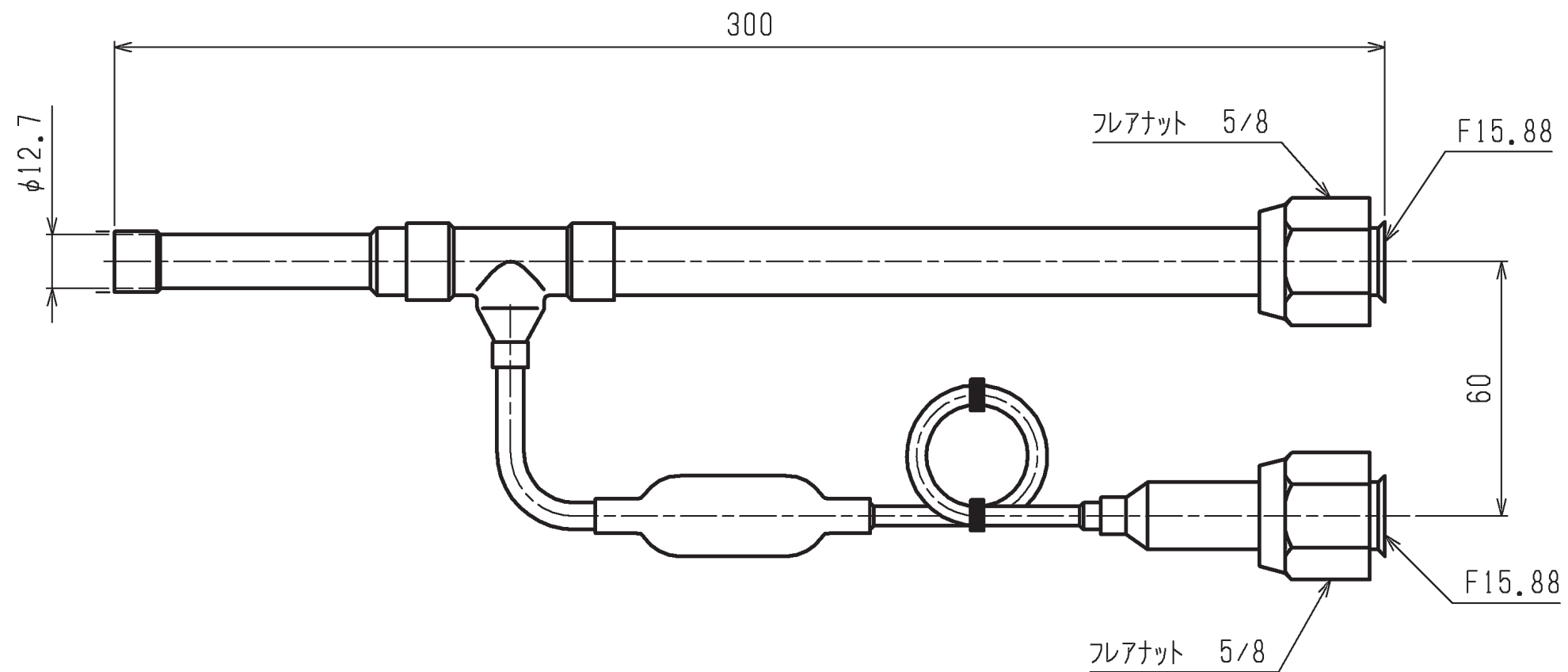

- 付属品：本体断熱カバー・・・1
- 断熱材・・・1
- パンタイ・・・3



	作成日付 ISSUED	改定日付 REVISED	TITLE PAC-KA22GK 高頭熱合流管キット外形図 (P36,P45用)		
	DIM. mm	14-10-03			
SCALE NTS	 三菱電機株式会社		DRW.NO. WKD94S794	REV.	PAGE 1/1