

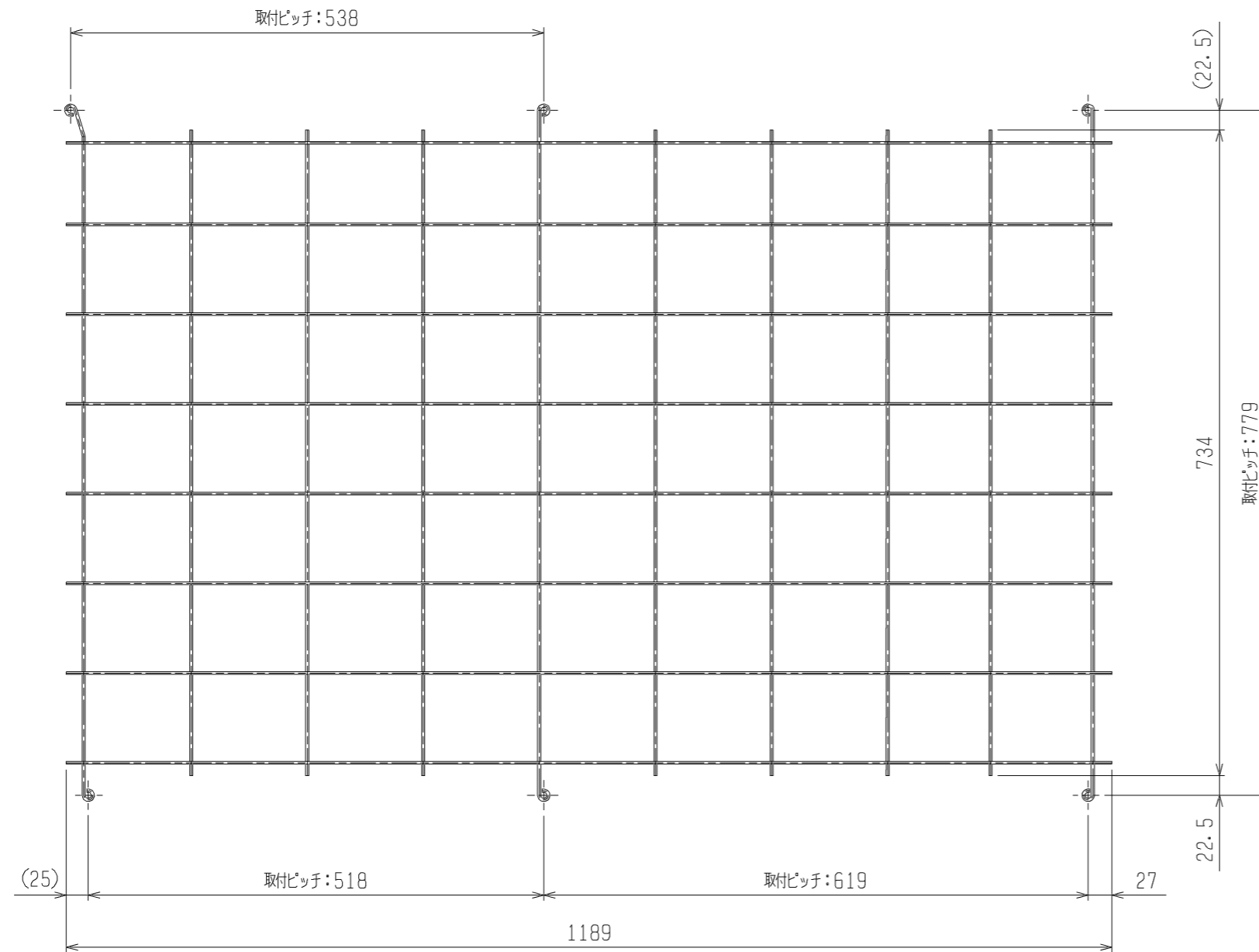

材質 : SWM-B (鋼線)
 表面処理 : PEコーティング
 色 : マンセル 2.7Y 7.74/1.02

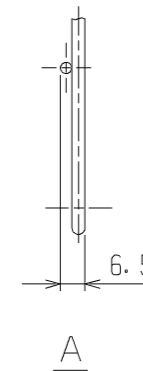

<取付部品>
 背面用網 2枚
 取付ネジ (M5×12) . . . 14本 (予備2本)

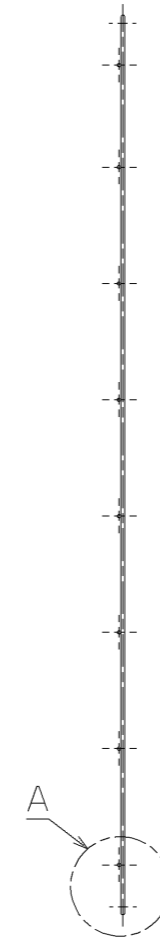
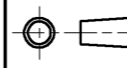

 DIM. mm	作成日付 ISSUED	改定日付 REVISED	TITLE PAC-KS13AM インバータマルチエアコン フリープランシステム 別売品 背面用網 外形図		
	11-06-02		DRW. NO.	REV.	PAGE
SCALE NTS	 三菱電機株式会社		WKD94L717	*	1/1

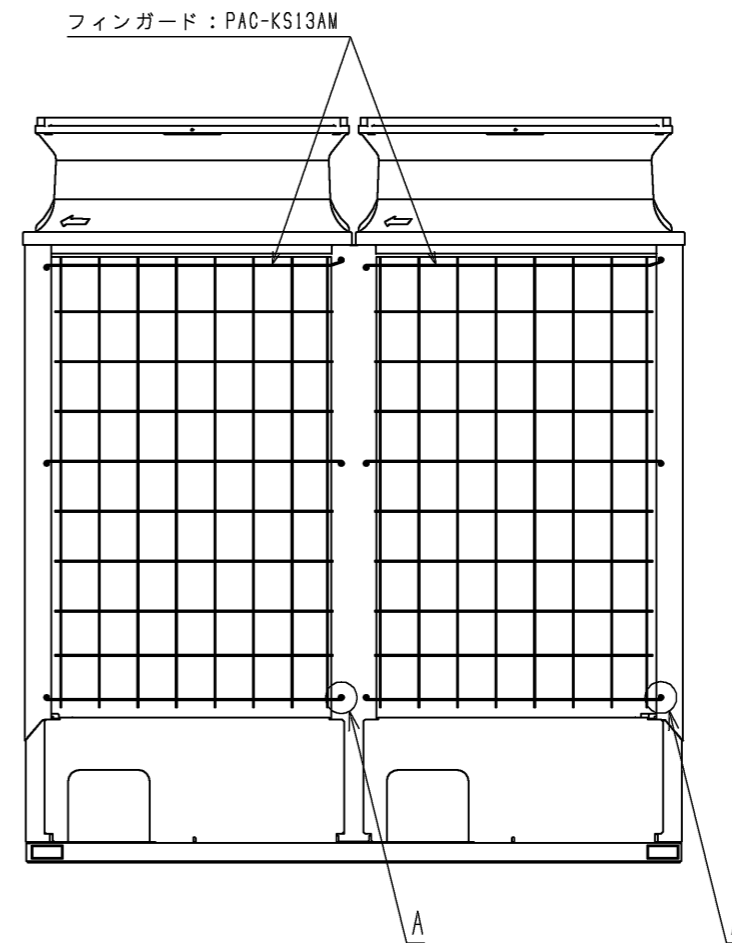
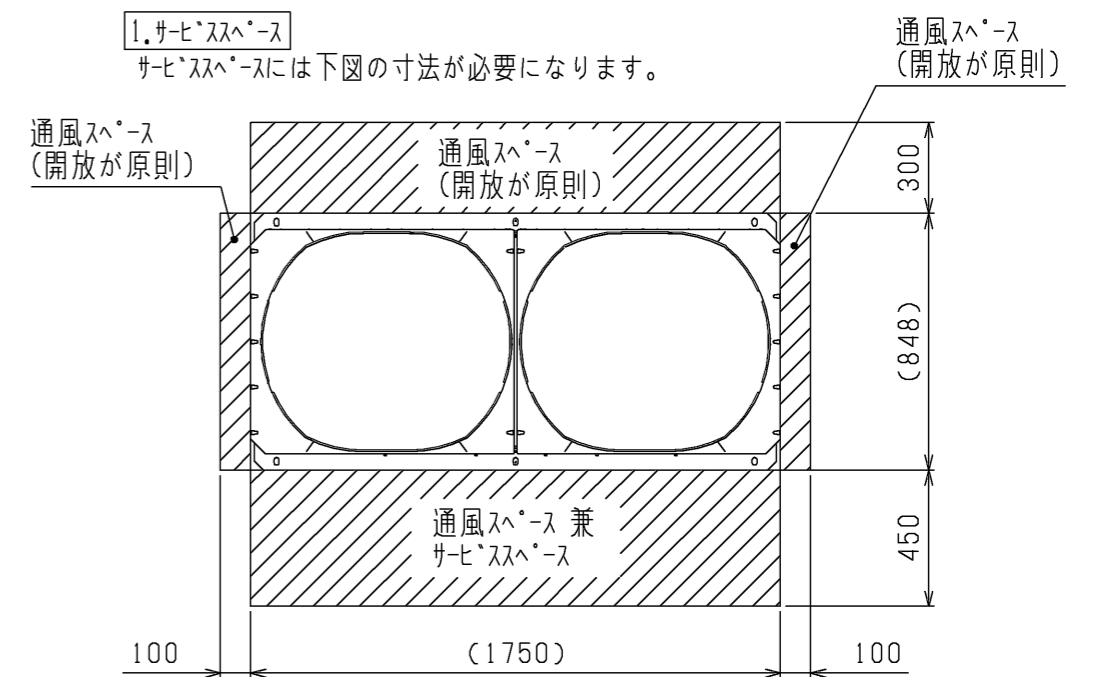
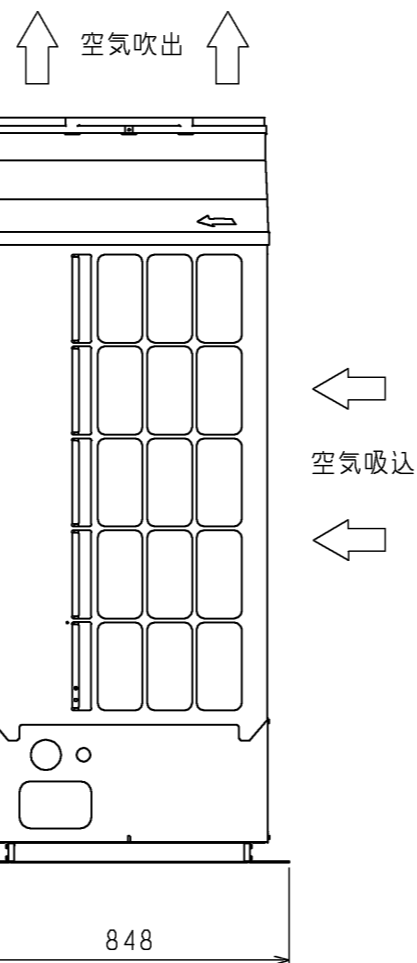
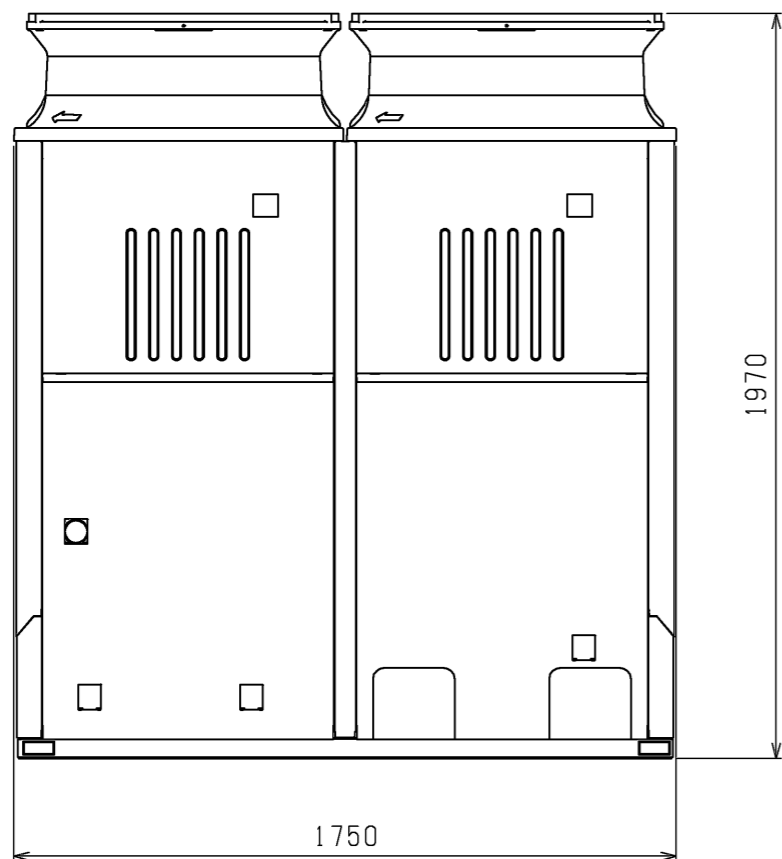
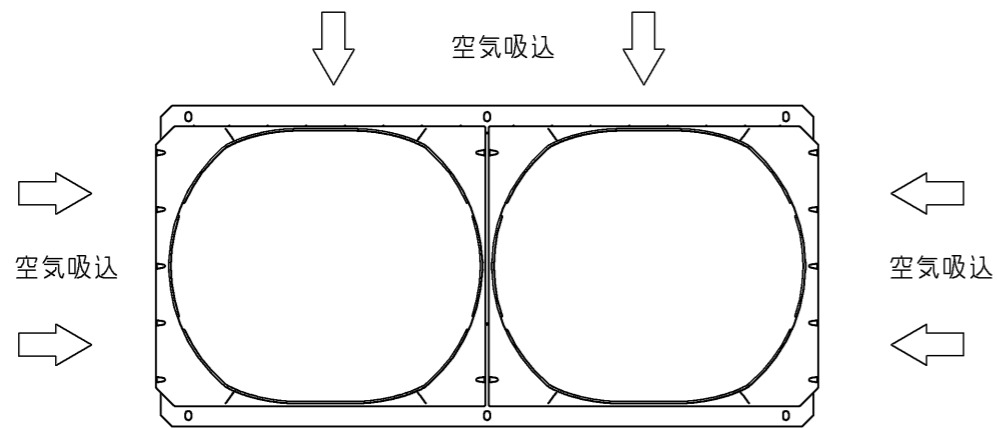

A<2カ所>
取付けねじ部拡大図

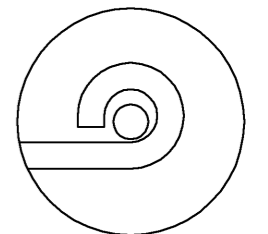

適用機種 : ECOV-EN150MC, EN185MC, EN225MC (-BS, -BSG)
 ECOV-EN150MC1, EN185MC1, EN225MC1 (-BS, -BSG)
 ECOV-EN150C, EN185C, EN225C (-BS, -BSG)
 ECOV-EN150C1, EN185C1, EN225C1 (-BS, -BSG)
 ECOV-EN110DCA, EN150DCA (-BS, -BSG)
 ECOV-EN110DCA1, EN150DCA1 (-BS, -BSG)
 ECOV-D150MA, D185MA, D225MA (-BS, -BSG)
 ECOV-D150MA1, D185MA1, D225MA1 (-BS, -BSG)
 ECOV-D150A, D185A, D225A (-BS, -BSG)
 ECOV-D150A1, D185A1, D225A1 (-BS, -BSG)

注.製品の仕様は改良のため、予告なく変更する場合があります。

本図面の所有権は三菱電機株式会社にある。
 THIS DOCUMENT IS THE PROPERTY OF MITSUBISHI ELECTRIC CORPORATION.

 DIMENSIONS ARE IN MILLIMETERS 尺度 SCALE DO NOT SCALE	作成日付 ISSUED	改定日付 REVISED	TITLE	REV.	PAGE
	2013-05-09	2023-04-05	一体空冷式インバータスクロール形 コンデンシングユニット 外形図 フィンガード PAC-KS13AM	B	1/1
三菱電機株式会社			DWG.NO.		
			W KN94R093		